

AUTEL® MAXISYS™

# ADAS

ADVANCED DRIVER ASSISTANCE SYSTEM

## STATIONARY

AUTEL STANDARD FRAME



## PORTABLE

AUTEL MA600 FRAME

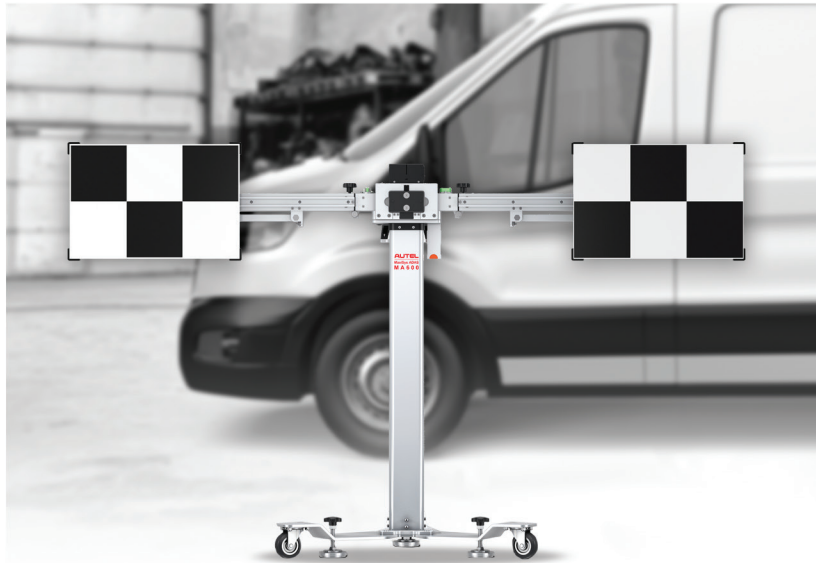

## CALIBRATION TOOL PACKAGES

CALIBRATION FOR CAMERA, RADAR & NIGHT VISION-BASED SYSTEMS.  
FOR COLLISION, GLASS REPLACEMENT & SPECIALTY REPAIR SHOPS.



[WWW.MAXISYSADAS.COM](http://WWW.MAXISYSADAS.COM)



## WHY SHOULD I OFFER ADAS REPAIRS?

- Repairing ADAS-equipped vehicles is becoming more of a necessity
- We provide the technology for shops to reap the benefits of ADAS repairs

## WHEN IS ADAS CALIBRATION REQUIRED?

- Windshield Replacement
- Suspension Repairs
- Wheel Alignment
- Tire Size Change
- Related DTC Is Present
- Sensor or Mounting Bracket Replacement
- Front Airbag Deployment If Deflected Off Windshield
- ADAS-Related TSBs/Manufacturer Position Statement Requirements\*
- Mechanical Procedures Like Radiator And Condenser Repairs That Require Removal Of Front-Mounted Sensors

*\*Refer to NHTSA, the manufacturer or ADAS Tech Support for more information*

## SERVICE PROFITS

- Having your own ADAS Calibration System saves you time and money that would be spent working with another shop
- It improves cycle time, allows your shop full control of the repair
- No longer transporting vehicles between shops increases up time
- Autel ADAS users report earning 50% ROI (full cost of investment) as early as 4-6 weeks with regular use

## WHICH FRAME TO CHOOSE?

Choosing which to consider largely depends on one thing...

**How do you intend to perform calibrations?**

- Q:** Are You Performing All ADAS Calibrations On Site?  
**A:** STANDARD FRAME
- Q:** Are You Performing ADAS Calibrations In Multiple Locations?  
**A:** MA600
- Q:** Are You Integrating ADAS Calibrations With An Alignment Machine?  
**A:** STANDARD FRAME

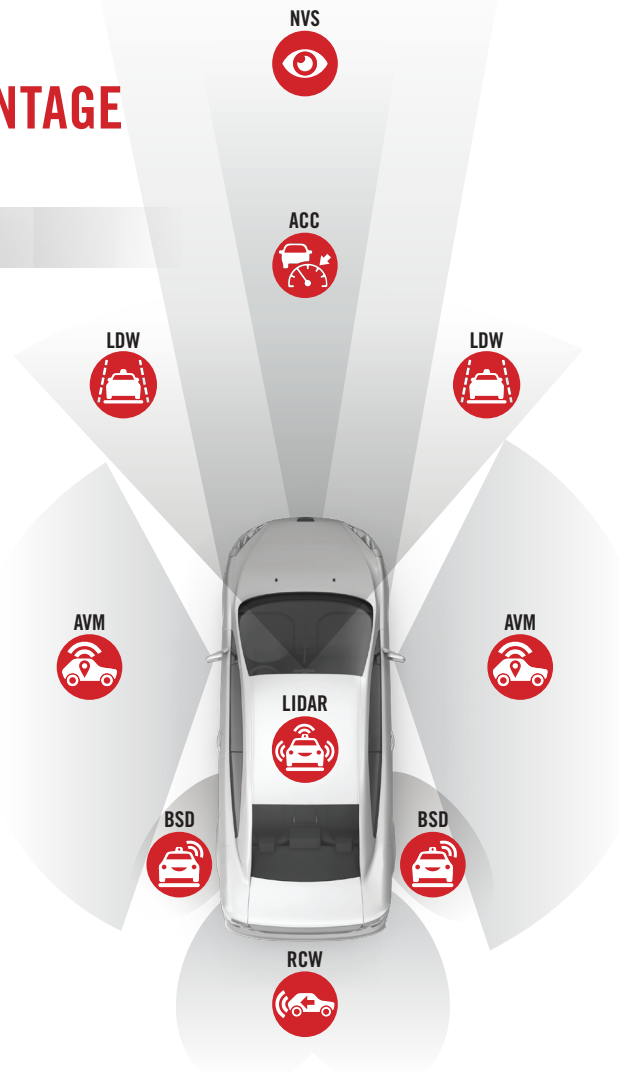

### ADAPTIVE CRUISE CONTROL (ACC)

Adjusts vehicle speed to maintain a safe distance with vehicles ahead



### AROUND VIEW MONITORING (AVM)

Provides 360-degree, bird's-eye view to help with drivers park more easily



### BLIND SPOT DETECTION (BSD)

Detects and warns driver of vehicles in either driver or passenger rear corners (blind spot)



### LANE DEPARTURE WARNING (LDW)

Warns the driver when the vehicle drifts out of their lane



### LIGHT IMAGING DETECTION AND RANGING (LIDAR)

Detects objects in vehicle vicinity to create a 3D map of objects and surroundings



### NIGHT VISION SYSTEM (NVS)

Improves a driver's vision in darkness or poor weather



### REAR COLLISION WARNING (RCW)

Warns the driver of vehicles coming close to the rear of their vehicle



# ADAS CALIBRATION FRAMES

## STANDARD FRAME

The Autel MaxiSYS ADAS Standard Frame is ideal for one-location shops or for use with an Alignment Machine. The sturdy, adjustable frame provides a new station to bring ADAS Calibration services in-house.

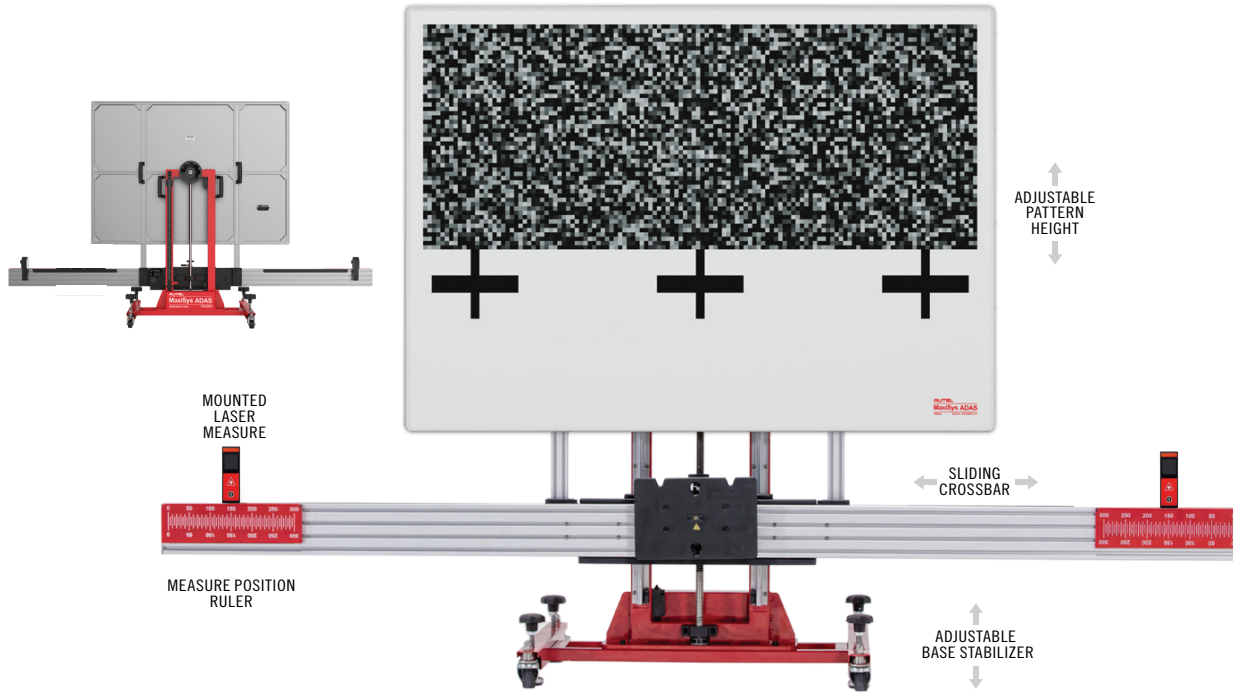

## MA600 FRAME

The Autel MaxiSYS ADAS MA600 Frame is ideal for multi-location shops. The compact frame, folds and disassembles to easily fit into the trunk of a car or service truck.

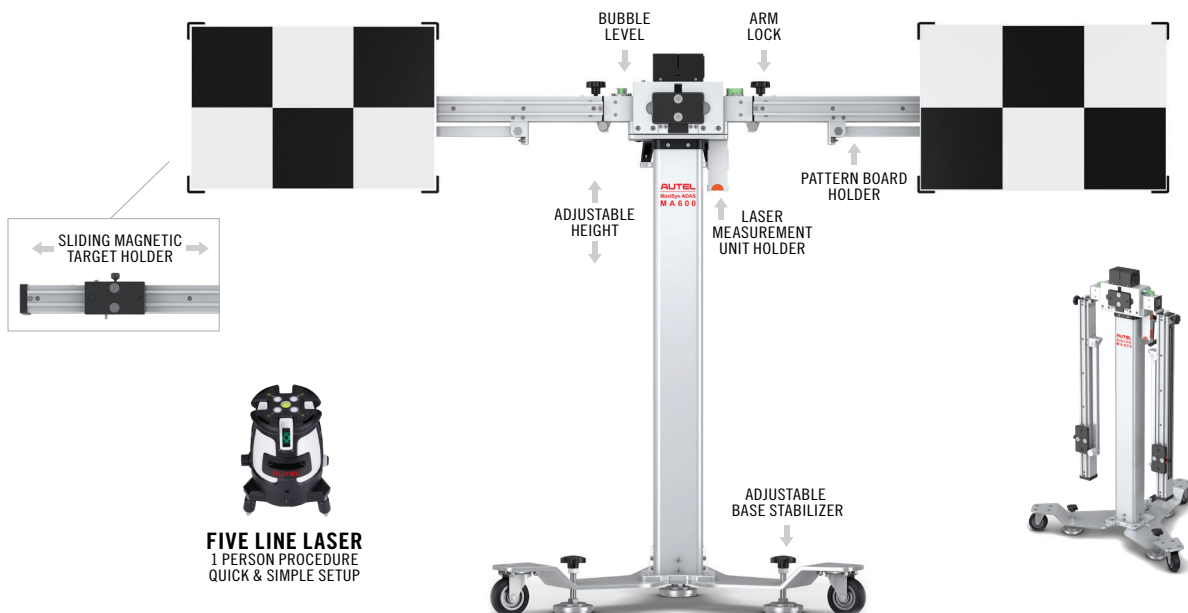

# ADAS STANDARD FRAME LDW PACKAGES

## INDUSTRY LEADING COVERAGE

The Autel ADAS Standard Frame is recommended if you perform ADAS Calibrations on site in your shop and/or plan on integrating ADAS Calibrations with an Alignment Machine.

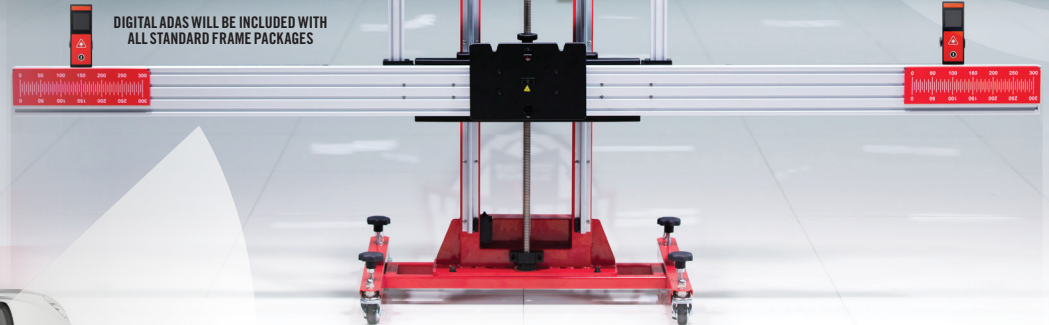
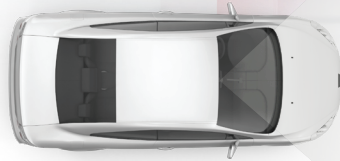

DIGITAL ADAS WILL BE INCLUDED WITH ALL STANDARD FRAME PACKAGES

- INCLUDES -  
AUTEL MAXISYS  
**MS909**  
WITH MAXIFLASH VCI



PART NO:  
LDW20T  
**ADAS LDW 2.0T**

EXPANDS LDW CALIBRATION CAPABILITIES  
ADAS SOFTWARE UPGRADE INCLUDED (SEE BACK FOR DETAILS)



**ADAS LDW 2.0** PART NO:  
LDW20

EXPANDS LANE DEPARTURE WARNING CALIBRATION CAPABILITIES  
ADAS SOFTWARE UPGRADE INCLUDED (SEE BACK FOR DETAILS)

### LANE DEPARTURE WARNING

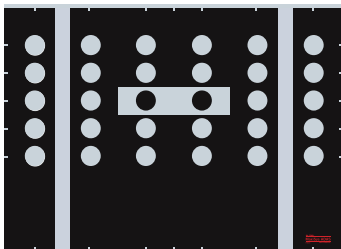

VW/AUDI/PORSCHE LDW  
CSC601/01

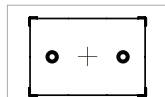

MERCEDES LDW  
CSC601/02



HONDA/ACURA LDW  
CSC601/05

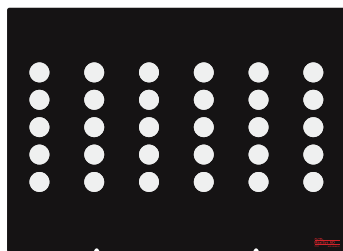

ALFA ROMEO LDW  
CSC601/10



NISSAN/INFINITI LDW  
CSC601/06-L

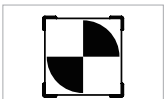

NISSAN/INFINITI LDW  
CSC601/06-R

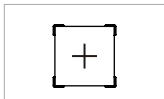

HYUNDAI/KIA LDW  
CSC601/09



TOYOTA/LEXUS LDW  
CSC601/11



MIITSUBISHI LDW  
CSC601/22-L

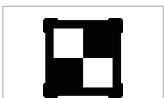

MIITSUBISHI LDW  
CSC601/22-R



SUBARU LDW  
CSC601/14

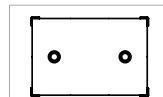

MAZDA LDW  
CSC601/12

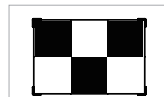

NISSAN LDW  
CSC601/03-L

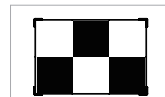

NISSAN LDW  
CSC601/03-R

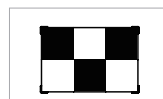

HONDA/ACURA LDW  
CSC601/08-L

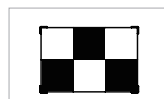

HONDA/ACURA LDW  
CSC601/08-R



TOYOTA/LEXUS LDW  
CSC601/15

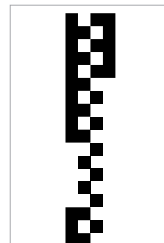

HYUNDAI/KIA LDW  
CSC601/07

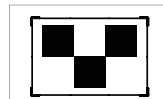

MAZDA LDW  
CSC601/13-L

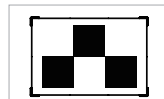

MAZDA LDW  
CSC601/13-R

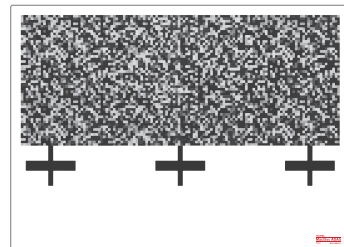

SUBARU LDW  
CSC601/17

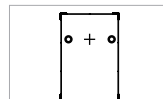

MERCEDES LDW  
CSC601/19

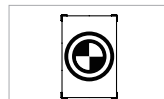

HONDA/ACURA LDW  
CSC601/24

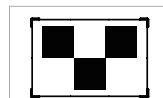

NISSAN/INFINITI LDW  
CSC601/04-L

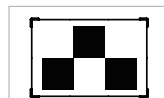

NISSAN LDW  
CSC601/04-R

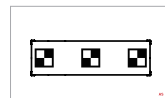

TOYOTA/LEXUS LDW  
CSC601/25



HYUNDAI/KIA LDW  
CSC701/23



# ADAS STANDARD FRAME ALL SYSTEMS PACKAGES

**BOTH INCLUDE  
LDW 2.0  
PACKAGE**

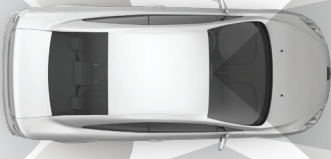

- INCLUDES -  
**AUTEL MAXISYS  
MS909**  
WITH MAXIFLASH VCI



## ADAS ALL SYSTEMS 2.0 PART NO: AS20

THE ULTIMATE FOR CALIBRATION CAPABILITIES  
ADAS SOFTWARE UPGRADE INCLUDED (SEE BACK FOR DETAILS)

## ADAS ALL SYSTEMS 2.0T PART NO: AS20T

THE ULTIMATE FOR CALIBRATION CAPABILITIES  
ADAS SOFTWARE UPGRADE INCLUDED (SEE BACK FOR DETAILS)

### AROUND VIEW MONITORING

VW AVM CSC804/01	HONDA AVM CSC1004/02	HONDA AVM CSC1004/03	CADILLAC AVM CSC1004/06	TOYOTA AVM CSC1004/10	HYUNDAI/ KIA AVM CSC1004/04	MITSUBISHI AVM CSC1004/09

### NIGHT VISION SYSTEM

VAG/GM NV CALIBRATOR CSC603/01	LEXUS NV PATTERN CSC603/03	MERCEDES NV STAND CSC803/01

### ADAPTIVE CRUISE CONTROL

ACC REFLECTOR CSC0602/01	RADAR CALIBRATION PLATE CSC602/02	VW ADR CALIBRATION PLATE CSC0602/08	HITACHI RADAR PLATE CSC802/03	NISSAN AVM CSC1004/11

### BLIND SPOT DETECTION

CENTER AXIS LASER CSC500/04	RADAR CALIBRATION BOX CSC605/01	CORNER REFLECTOR STAND CSC800	CORNER REFLECTOR CSC802/01	TARGET STAND CSC802	HONDA LANEWATCH CSC805/02

### LIDAR

VW/AUDI LIDAR CALIBRATION BOARD CSC602/04	TOYOTA LIDAR REFLECTOR CSC802/04

### REAR COLLISION WARNING

VW RCWI CSC806/01	MERCEDES RCWI CSC1006/01	MERCEDES RCWII CSC1006/02	NISSAN RCWI CSC1006/03	NISSAN RCWII CSC1006/05

# MA600 FRAME LDW PACKAGES

## INDUSTRY LEADING COVERAGE

If you plan on performing ADAS Calibrations in multiple locations, then the Autel ADAS MA600 Frame is the perfect fit for you. Easy to set-up and disassemble, it's ideal for the tech on-the-go.

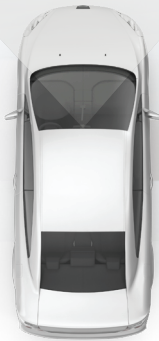

- INCLUDES -  
**AUTEL MAXISYS**  
**MS909**  
WITH MAXIFLASH VCI



**MA600** PART NO: MA60020T  
**LDW 2.0T**

EXPANDS LDW CALIBRATION CAPABILITIES  
ADAS SOFTWARE UPGRADE INCLUDED (SEE BACK FOR DETAILS)



**MA600 LDW 2.0** PART NO: MA60020

EXPANDS LANE DEPARTURE WARNING CALIBRATION CAPABILITIES  
ADAS SOFTWARE UPGRADE INCLUDED (SEE BACK FOR DETAILS)

### LANE DEPARTURE WARNING

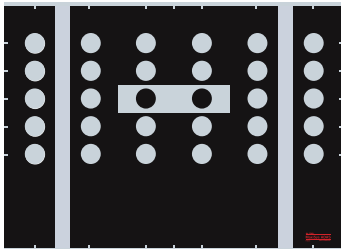

VW/AUDI/PORSCHE LDW  
CSC601/01

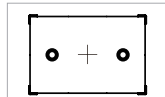

MERCEDES LDW  
CSC601/02



HONDA/ACURA LDW  
CSC601/05

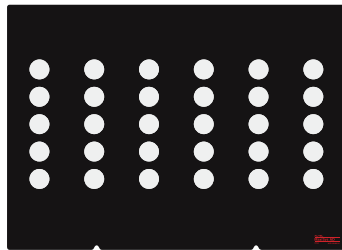

ALFA ROMEO LDW  
CSC601/10



NISSAN/INFINITI LDW  
CSC601/06-L

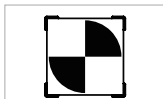

NISSAN/INFINITI LDW  
CSC601/06-R

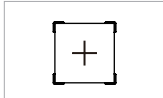

HYUNDAI/KIA LDW  
CSC601/09



TOYOTA/LEXUS LDW  
CSC601/11



MITSUBISHI LDW  
CSC601/22-L



MITSUBISHI LDW  
CSC601/22-R



SUBARU LDW  
CSC601/14

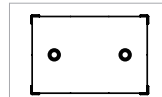

MAZDA LDW  
CSC601/12

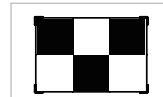

NISSAN LDW  
CSC601/03-L

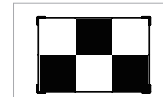

NISSAN LDW  
CSC601/03-R

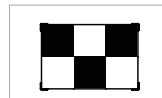

HONDA/ACURA LDW  
CSC601/08-L

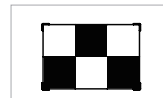

HONDA/ACURA LDW  
CSC601/08-R



TOYOTA/LEXUS LDW  
CSC601/15

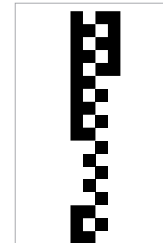

HYUNDAI/KIA LDW  
CSC601/07

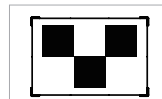

MAZDA LDW  
CSC601/13-L

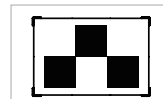

MAZDA LDW  
CSC601/13-R

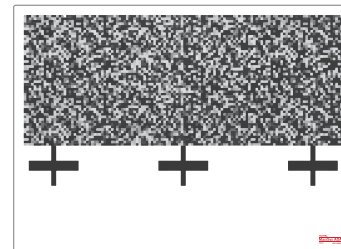

SUBARU LDW  
CSC601/17

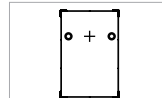

MERCEDES LDW  
CSC601/19



HONDA/ACURA LDW  
CSC601/24-01

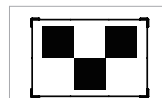

NISSAN/INFINITI LDW  
CSC601/04-L

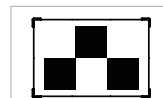

NISSAN LDW  
CSC601/04-R

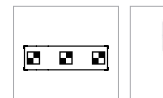

TOYOTA/LEXUS LDW  
CSC601/25



HYUNDAI/KIA LDW  
CSC701/23



TOYOTA LDW  
CSC601/11-01

# MA600 FRAME ALL SYSTEMS PACKAGES



**BOTH INCLUDE  
LDW 2.0  
PACKAGE**

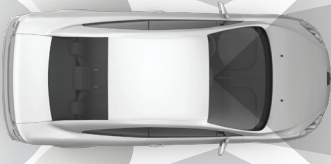

- INCLUDES -  
**AUTEL MAXISYS  
MS909**  
WITH MAXIFLASH VCI



## MA600 ALL SYSTEMS 2.0 PART NO: MAS20

THE ULTIMATE FOR CALIBRATION CAPABILITIES  
ADAS SOFTWARE UPGRADE INCLUDED (SEE BACK FOR DETAILS)

## MA600 ALL SYSTEMS 2.0T PART NO: MAS20T

THE ULTIMATE FOR CALIBRATION CAPABILITIES  
ADAS SOFTWARE UPGRADE INCLUDED (SEE BACK FOR DETAILS)

### AROUND VIEW MONITORING

VW AVM CSC804/01	HONDA AVM CSC1004/02	HONDA AVM CSC1004/03	CADILLAC AVM CSC1004/06	TOYOTA AVM CSC1004/10	HYUNDAI/ KIA AVM CSC1004/04	MITSUBISHI AVM CSC1004/09

### NIGHT VISION SYSTEM

VAG/GM NV CALIBRATOR CSC603/01	LEXUS NV PATTERN CSC603/03	MERCEDES NV STAND CSC803/01

### ADAPTIVE CRUISE CONTROL

ACC REFLECTOR CSC0602/01	RADAR CALIBRATION PLATE CSC602/02	VW ADR CALIBRATION PLATE CSC0602/08	HITACHI RADAR PLATE CSC802/03	NISSAN AVM CSC1004/11

### BLIND SPOT DETECTION

RADAR CALIBRATION BOX CSC605/01	CORNER REFLECTOR STAND CSC800	CORNER REFLECTOR CSC802/01	TARGET STAND CSC802	HONDA LANEWATCH CSC805/02

### LIDAR

VW/AUDI LIDAR CALIBRATION BOARD CSC602/04	TOYOTA LIDAR REFLECTOR CSC802/04

### REAR COLLISION WARNING

VW RCWI CSC806/01	MERCEDES RCWI CSC1006/01	MERCEDES RCWII CSC1006/02	NISSAN RCWI CSC1006/03	NISSAN RCWII CSC1006/05

### FRAME ACCESSORY

MOUNTING PLATE: FRAME ADAPTER FOR SELECT ACCESSORIES MA600RAP

LASER MEASUREMENT UNIT	TWO LINE LASER CSC1500/03	L BRACKET CSC1500/04	FIVE LINE LASER CSC1500/05	LASER ASSISTED REFLECTOR CSC1500/06	PLUMB LINE CSC1500/07	LASER REFLECTIVE BOARD CSC1500/08



SMARTER DIAGNOSTICS

# STARTS HERE

AVAILABLE WITH SELECT PACKAGES

AUTEL® MAXISYS™  
**MS909**  
WITH MAXIFLASH VCI



— FEATURES INCLUDE —

**INTELLIGENT DIAGNOSTICS**

- REPAIR ASSIST
- GUIDED DIAGNOSTICS

**TOPOLOGY MODULE MAP**

- ALL SYSTEM STATUS SCREEN
- COLOR CODED FAULTS

**POWERFUL HARDWARE**

- OCTA-CORE PROCESSOR
- 128GB MEMORY

INCLUDED WITH ALL PACKAGES  
VALUED AT \$995

NOW YOU CAN ADD ADAS SOFTWARE TO ANY MAXISYS TABLET

Autel ADAS Software features easy-to-use graphic instruction to guide you through the entire calibration process.



Autel ADAS Software for the Standard & MA600 Frame System is compatible with the following MaxiSYS Tablets:

- MS908
- MS908P
- MS908S
- MS908SP
- MSELite
- MS909
- MS919
- MSUltra

