

# Classico 311

Comfort

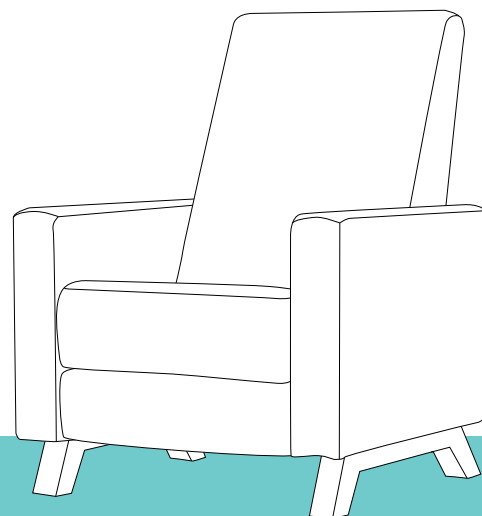

## Product code summary

311 126 79 5211\*

\*For reference only

1

Model

311 120

311 126

311 170

311 171

**Technogel® option**

311 T20

311 T26

311 T70

311 T71

2

Finish

**Wood legs:**  
All finishes except Walnut\*

**Metal legs:** 56

3







Cover

All fabrics, leathers and leather matches\*

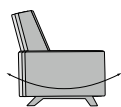
**C.O.M.** yardage requirement: 5.5

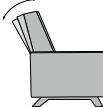
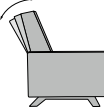
\*See complete color chart in the general information document

## Glider options

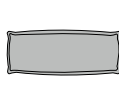
								
	Glide	Multiposition lock	Recline	Integrated footrest	Technogel®	Electric motor	Battery-powered motor	Lumbar pillow
311 120	●	●	●					
311 126	●	●	●	●				
311 170	●	●	●	●		●		
311 171	●	●	●	●			●	
311 T20	●	●	●		●			
311 T26	●	●	●	●	●			
311 T70	●	●	●	●	●	●		
311 T71	●	●	●	●	●		●	
99306*								●

\*Indicate the lumbar pillow code followed by your cover choice number

## Features and benefits

- Ergonomic design with reclining backrest and superior lumbar support
- Long and smooth gliding motion for ultimate relaxation
- Optional integrated Technogel® padding for next level comfort
- Available in a variety of fabrics, leathers and leather matches to cater to everyone's taste
- Made in Canada by our skilled craftsmen

## Technogel®

- Unique comfort on the market
- Eliminates body pressure for joint relief
- Absorbs and disperses body heat
- Exclusive partnership with Dutailier



## Dimensions

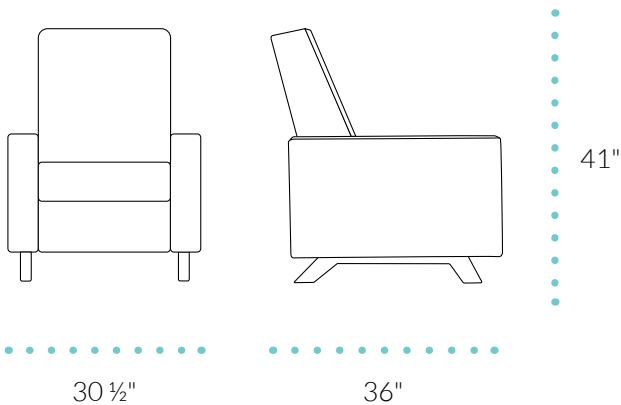

### Additional Information

Box: 36 3/8"W x 32"D x 36"H

Volume: 24.2 ft<sup>3</sup> / 0.69 m<sup>3</sup>

Weight 120: 110 lb / 49.9 kg

Weight 126: 121 lb / 54.9 kg

Weight 170: 135 lb / 61.4 kg

Weight 171: 137 lb / 62.3 kg

Metal legs weight: add 15 lb / 6.8 kg

Not UPSable

## Frame

Legs and base: Birch laminated or metal

Finish: Stain, sealer and lacquer

## Cushion

Polyester fiber and polyurethane foam

Density: 2.55 lb/ft<sup>2</sup>

Compression: 35 lb/ft<sup>2</sup>

Seat and back decking: No-sag spring

Technogel® seating option

## Technogel®

Odorless, non-toxic and hypoallergenic

100% polyurethane

Made in Italy

## Mechanism

Gliding motion integrated into the armrests

Exclusive Dutailier mechanism

# Gliding ottoman 313

Comfort

## Product code summary

313 190 79 5211\*

\*For reference only

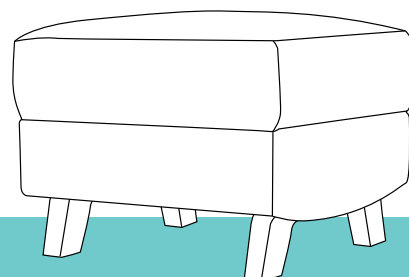

1

Model

313 190

2

Finish

**Wood legs:**  
All finishes except Walnut\*

**Metal legs:** 56

3

Cover

All fabrics, leathers  
and leather matches\*

**C.O.M.** yardage requirement: 1.3

\*See complete color chart in the general information document

## Ottoman dimensions

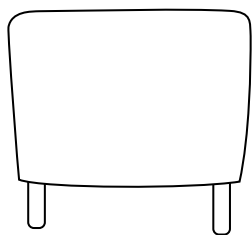

19 3/4"

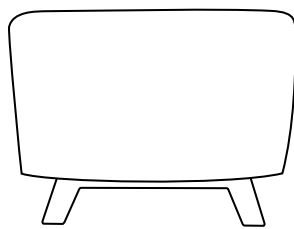

18 1/2"

16"

### Additional Information

Box: 20 3/4" L x 20 1/2" P x 17 5/8" H

Volume: 4.8 ft<sup>3</sup> / 0.15 m<sup>3</sup>

Weight: 30 lb / 13.6 kg

Metal legs weight: add 8 lb / 3.6 kg

UPSable



T 450.772.2403  
1.800.363.9817  
F 450.772.5055  
1.888.230.2403  
info@dutailier.com

dutailier.com