

# equinox

## Compressor Nebulizer

### EQ-NL-72

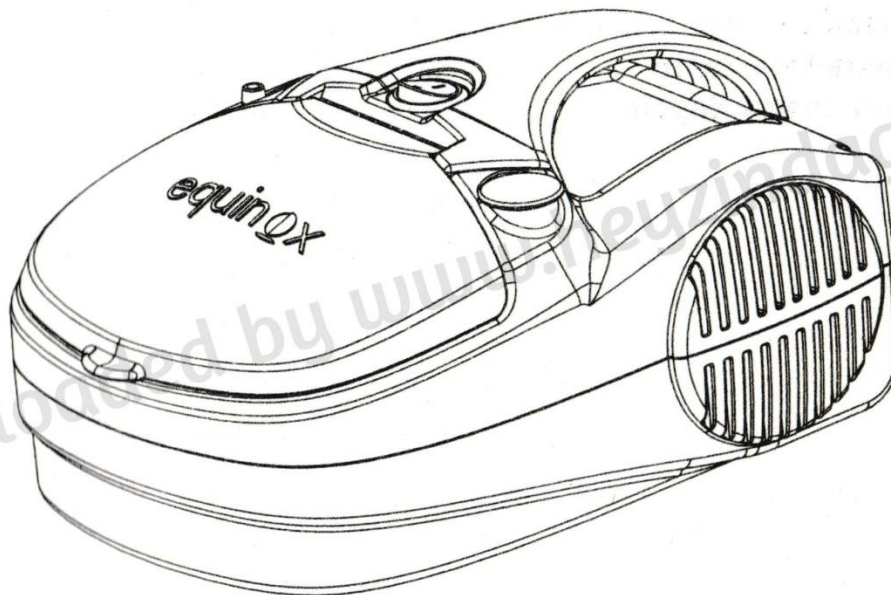

## **USER MANUAL**

---

- Thanks for selecting our Compressor Nebulizer EQ-NL-72.
- Please do read the user manual carefully and thoroughly.
- Keep it safe for future reference.

## Index

	Page
1. Illustration of Parts. ....	2
2. Introduction. ....	3
3. Safety Precautions. ....	3
3-1. Nebulizer Compressor Safety Precautions. ....	4
3-2. Nebulizer and Accessories Safety Precautions. ....	5
4. Getting Started. ....	5
5. Setting Up the Nebulizer Compressor and Nebulizer Accessories. ....	6
6. Operating the Compressor Nebulizer. ....	9
7. Cleaning the Nebulizer Components / Accessories. ....	11
8. Disinfecting & Sterilizing Nebulizer Components & Accessories. ....	11
9. Maintenance. ....	12
10. Specifications. ....	13
11. Limited Warranty. ....	14
12. Service and Repair. ....	14

Uploaded by [www.heyzindagi.in](http://www.heyzindagi.in)

# 1. ILLUSTRATION OF PARTS

## A. NEBULIZER COMPRESSOR UNIT

- 1. Kit Container
- 2. Air Outlet
- 3. Power Switch
- 4. Power Cord
- 5. Air Filter

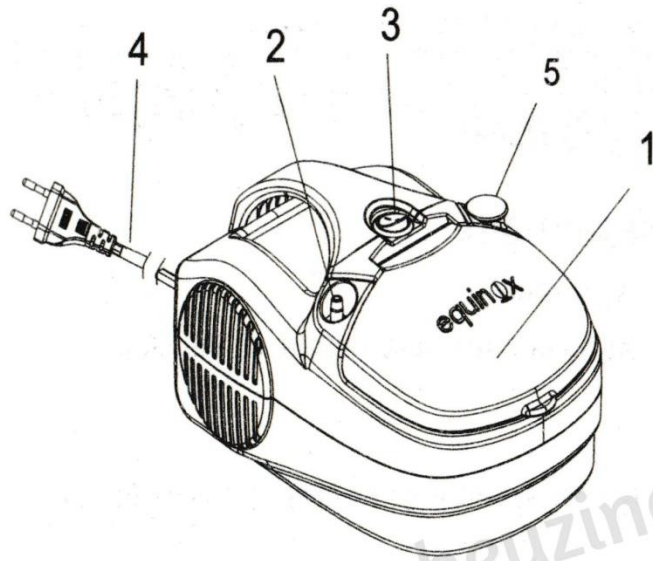

Figure 1

## B. NEBULIZER ASSEMBLY AND ACCESSORIES ILLUSTRATION

- 1. Tubing
- 2. Nebulizer Cup
- 3. Nebulizer Insert
- 4. Nebulizer Cap
- 5. Mask
- 6. Mouthpiece

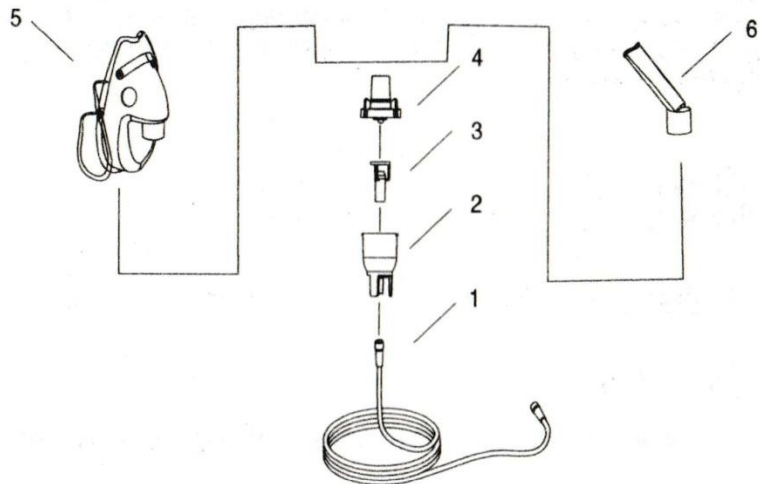

Figure 2

## **2. INTRODUCTION**

This nebulizer is a portable medical device intended to aerosolize physician-prescribed medication which is inhaled through a mouthpiece or mask. A nebulizer may be used instead of a metered dose inhaler. The device consists of a compressor unit and nebulizing attachments.

These instructions contain important information and safety precautions for the nebulizer. Illustrations of the compressor unit and tubing and accessories are on page 2. Before using your nebulizer, you should read and understand the entire **User Manual** for the compressor unit and tubing and accessories. Take special note of all safety precautions marked **DANGER** and **WARNING**.

## **3. SAFETY PRECAUTIONS**

### **IMPORTANT SAFEGUARDS**

**READ ALL WARNINGS BEFORE USING YOUR NEBULIZER.**

#### **WARNING**

**Caution: Use only when prescribed by a physician and with the prescribed medication.**

**Read all warnings and user manual before use. Use the product only for its intended use as described in the user's manual. Improper use can result in serious or fatal illness/injury, improper treatment or property damage.**

**Use only with nebulizers, tubing and accessories authorized provided for this device. Other nebulizers, tubing and accessories may result in improper treatment. Other compressors and tubing may produce incorrect flow, resulting in improper dosage. Use with other compressors, tubing and accessories should be reviewed with your healthcare professional.**

#### **CAUTION**

**This appliance is not for unattended use.**

### **3-1. NEBULIZER COMPRESSOR SAFETY PRECAUTIONS**

#### **DANGER**

**To reduce the risk of serious or fatal injury from electrocution (electric shock):**

1. Do not place or store the product where it can fall or be knocked into bathtub, sink, water, or other liquid. Do not place or drop into any liquid. Do not use while bathing.
2. Do not reach for a product that has fallen into water or other liquid. Unplug immediately.
3. Always unplug immediately after using.

 **WARNING**

To reduce the risk of serious or fatal injury from electrocution, fire, burns and to reduce the risk of damage or malfunction of the unit:

1. Before use, check the serial number label on the bottom of the compressor to ensure that the voltage and current indicated on the unit correspond with the voltage and current available.
2. Never operate this product if it:
  - has a damaged cord or plug,
  - is not working properly,
  - has been dropped or damaged,
  - has been exposed to any liquids inside the case.

Return non-operating product to an authorized dealer for examination, repair or replacement.

3. Keep all electrical cords away from heated surfaces. Do not overload wall outlets or use extension cords.
4. Do not operate where oxygen is being administered in a closed environment such as an oxygen tent.
5. Never drop or insert any object into any openings.
6. Do not open or disassemble the compressor. Refer all servicing to us or authorized medical equipment service centers.
7. Never spray liquids onto the compressor housing. Fluid could cause damage to the electrical and compressor parts and could lead to malfunction. In the event that fluids enter the unit, return the product to authorized service center for Equinox.
8. Do not use the nebulizer while operating a vehicle.
9. EMI/RFI recommendations:
  - a. Do not turn on or use hand-held personal electronic communication devices such as cellular phones, walkie-talkies, smart devices and CB radios while the compressor is turned on.
  - b. Be aware of any nearby transmitters (radio, television, microwave, etc.) and avoid operating the compressor close to any those transmitters.
  - c. Turn off the power if the compressor is not going to be used for any length of time.
  - d. Be aware that adding accessories or components or modifying the compressor may make it more susceptible to EMI/RFI."

**\* EMI/RFI - Electromagnetic interference and Radio frequency interference**

### 3-2. NEBULIZER AND ACCESSORIES SAFETY PRECAUTIONS

 **WARNING**

1. Tubing and accessories are for single patient use only. Do not share your tubing and accessories with other patients.
2. To reduce the risk of increased bacterial growth, infection, illness, or injury from contamination, thoroughly clean and dry all parts of tubing and accessories and thoroughly dry any moisture or condensation in the tubing at the end of every treatment, following the instructions below.
3. Cleaning the Nebulizer unit after each treatment is not enough--- the tubing and accessories must also be regularly sterilized and disinfected between treatments to prevent serious or fatal illness caused by contamination.
4. Never use tubing with a clogged nozzle. If the nozzle is clogged, the aerosol mist will be reduced, altered or stopped, which will diminish or eliminate the effectiveness of the treatment. If clogging occurs, replace with the same model.
5. Close supervision is necessary when this product is used by or near children and physically or mentally impaired persons. Never use when sleeping or drowsy.
6. This product contains small parts that may present a choking hazard to small children. The tubing also presents a strangulation hazard.

 **WARNING: ALWAYS USE CLOSE ADULT SUPERVISION WHEN ADMINISTERING TREATMENT TO A CHILD. DO NOT LEAVE CHILD UNATTENDED DURING TREATMENT.**

7. Children under the age of 3 or any patient who is unable to use a mouthpiece properly under supervision should use a mask (optional).
8. Before use, check tubing and accessories for proper assembly. All parts should be seated firmly in place. Use of improperly assembled tubing and accessories could diminish or prevent adequate delivery of medication and the effectiveness of the treatment.

### 4. GETTING STARTED

1. Check to ensure the following components of the nebulizer are enclosed:
  - Compressor unit
  - Tubing and Accessories (See page 2 for illustration of parts)

*If you did not receive the components listed, please contact the dealer or distributor where you purchased your Nebulizer.*

2. It is always a good idea to keep extra tubing and accessories and an extra air filter on hand at all times. You may need them if parts become lost, damaged, or soiled.

## **5. SETTING UP THE NEBULIZER COMPRESSOR AND NEBULIZER ACCESSORIES**

1. Wash hands with soap and warm water and dry completely with a clean towel.
2. Place the compressor on a clean, dust-free, stable and flat surface. Check the filter monthly or every 10-12 treatments and replace if dirty, clogged, or wet to ensure proper operation (Figure-3).

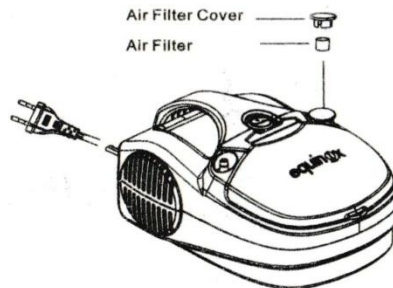

Figure 3

**⚠ Note: Tubing and accessories are NOT sterile from package.**

3. **Make sure tubing and accessories have been cleaned and/or disinfected before first use and after last daily treatment. Refer to the Cleaning and Disinfecting Tubing and Accessoires section on page 12.**
4. **Remove the nebulizer cap by twisting counter-clockwise until it stops and lift up (Figure 4-1).**
5. **Fill nebulizer cup using eyedropper or syringe with prescribed medication. Do not fill more than 6 ml per treatment (Figure 4-2).**
6. **Close the nebulizer cap and turn clockwise until it is tightened (Figure 4-3).**

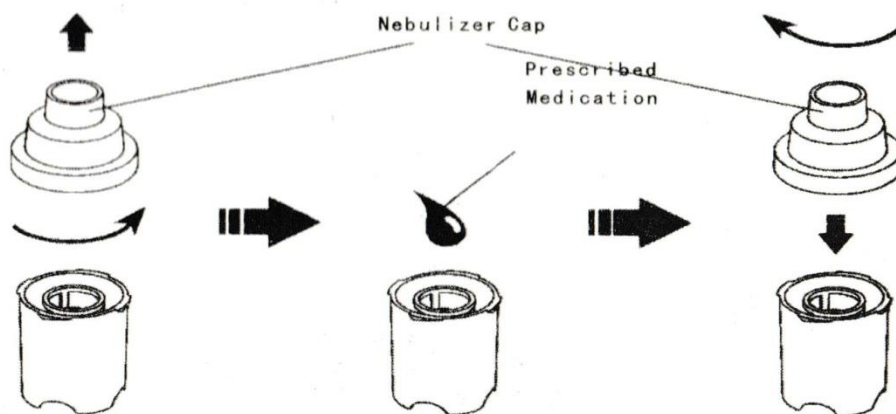

Figure 4-1

Figure 4-2

Figure 4-3

7. If using the mask, press it directly into the outlet of nebulizer cap. (Figure 4).

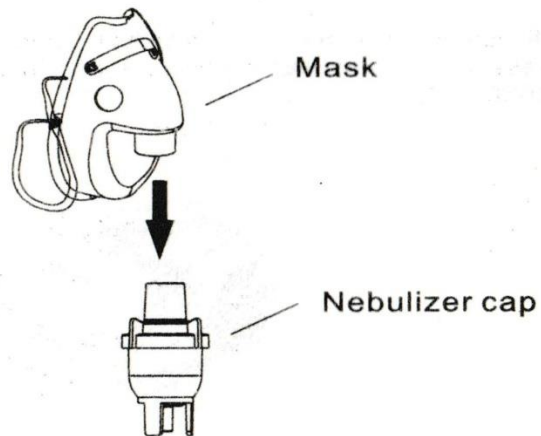

Figure 5

8. If using the mouthpiece, attach it firmly into the nebulizer cap. The cap is designed to fit tightly (Figure 5).

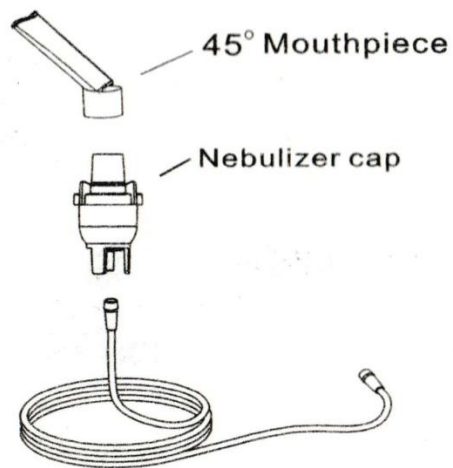

Figure 6



9. Press one end of the tubing firmly onto to the air outlet on the front of the compressor unit. It is important that the tubing be pushed firmly all the way onto the air outlet of the compressor unit. The tubing is designed to fit tightly (Figure 7-1).
10. Firmly press the other end of the tubing onto the bottom of the nebulizer cup (Figure 7-2).

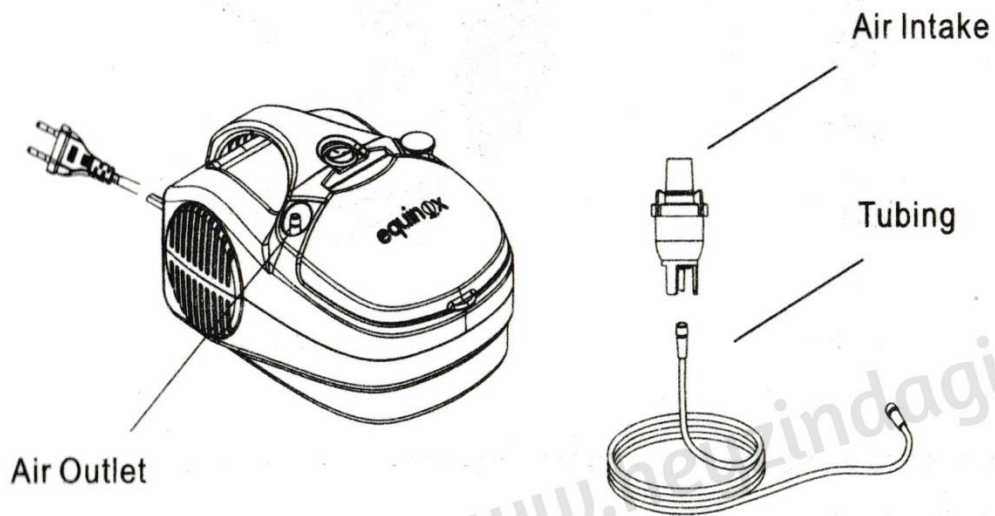

Figure 7-1

Figure 7-2

## 6. OPERATING THE COMPRESSOR NEBULIZER

1. Take the power cord out of the storage cavity and plug into an electrical outlet.

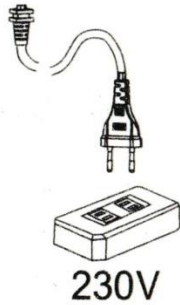

Figure 8

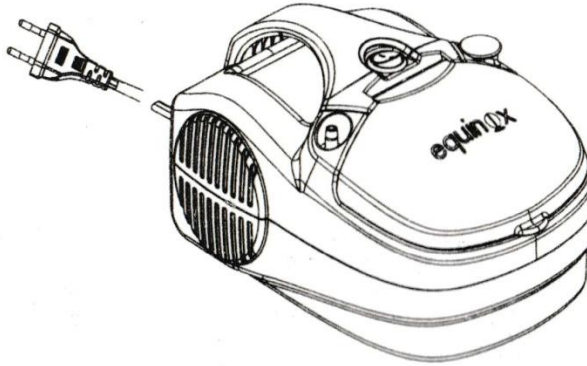

Figure 9

2. Locate the power switch on the front of the unit, and switch it to the "on" position as shown below.

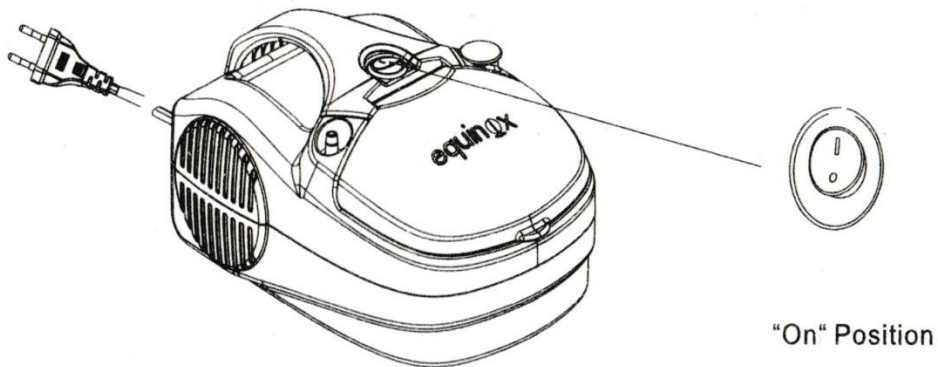
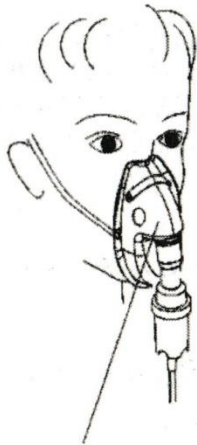

Figure 10

3. Check for moisture leakage near the connections.

4. Hold the mask on the face (Figure 11-1). If using a mouthpiece, hold it in the mouth (Figure 11-2)



Mask  
Figure 11-1



Mouthpiece  
Figure 11-2

5. Inhale the liquid medication moisture.

6. When liquid medication is depleted, turn the power switch to the off position.

**NOTE:** For optimal performance operate the unit 20 minutes on then leave off for 40 minutes.

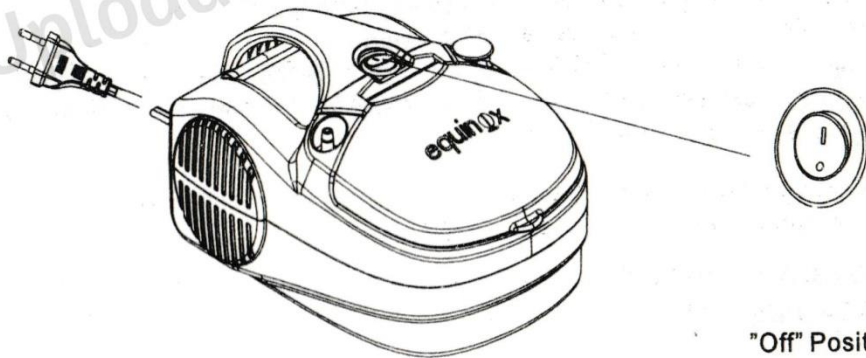

Figure 12

7. Unplug the power cord from the electrical outlet and tuck it into cord storage cavity.

8. Detach the tubing and accessory from the compressor unit.

9. Clean and sterilize tubing and accessories.

---

## **7. CLEANING THE NEBULIZER COMPONENTS AND ACCESSORIES**

1. Disconnect the tubing from the compressor and from the bottom of the nebulizer cup.
2. If there is any moisture (condensation) in the tubing, let the compressor run with the tubing only for 2-3 minutes. The warm air from the compressor will dry out the tubing. Alternatively, you can dry the tubing by removing it from the compressor and hanging it up with the "ends down" to allow the moisture or condensation to drain out and evaporate. Use a clean damp cloth to wipe the exterior of the tubing.
3. Disassemble tubing and accessories as illustrated.
4. Wash all parts with warm water and liquid dish soap. **DO NOT WASH THE TUBING.**
5. Rinse thoroughly with warm water and shake out water.
6. Air dry or hand dry nebulizer parts on a clean, lint free cloth. Reassemble nebulizer when parts are dry and store.
7. You can also wash the accessories in the top shelf of a dishwasher. Masks cannot be washed safely in a dishwasher. **DO NOT WASH THE TUBING.** Place the parts in a dishwasher basket and place the basket on the top rack of the dishwasher. Remove and dry parts when the cycle is complete.

## **8. DISINFECTING AND STERILIZING NEBULIZER COMPONENTS AND ACCESSORIES**

1. Clean the nebulizer components and accessories as described in cleaning section. Every alternate day when taking the treatment regularly from the nebulizer soak the parts in a solution of 1 part distilled white vinegar and 3 parts hot tap water for 1 hour, **DO NOT SOAK THE TUBING.** You can substitute commercially available respiratory equipment disinfectant for distilled white vinegar by following manufacturer's instructions for mixing.
2. Rinse all parts thoroughly with warm tap water and dry with a clean, lint-free cloth. Discard vinegar solution when disinfecting is complete.
3. Tubing and accessories must be stored in a sterilizing box before using and must be sterilized periodically after use.

### **WARNING**

**Only one patient should use one set of tubing and accessories. Do not share components with other patients**

## 9. MAINTENANCE

**⚠ NOTE:** To equipment provider: The following accessories replacement package is recommended:

Tubing	Mouthpiece	Adult mask
Nebulizer	Air filters(5)	Child mask

**AIR FILTER:** The air filter on the top panel of the compressor unit is bright white when new. With use, it will turn grey, which means it is time to replace it. It must be replaced immediately if it gets wet or becomes clogged. The air filter lasts up to 500 hours of use before replacement. A general rule is to replace the air filter whenever the nebulizer unit is replaced (every 6 months). To replace the air filter, ensure the compressor is turned off, open the air filter cover to take out the air filter and replace it with a new one. Place the cap back into the socket of the compressor and snap the filter cover back in place.

### NOTE

Do not attempt to wash and reuse the air filter. Do not use substitute filter material. Compressor damage may result. It may result in the damage of the compressor.

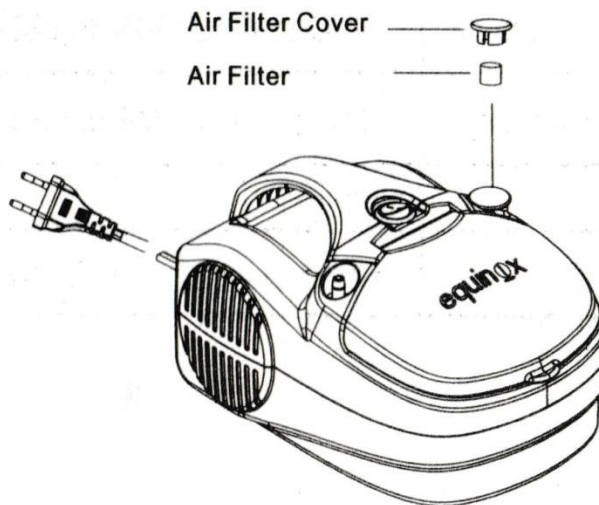

Figure 13

**CLEANING THE COMPRESSOR HOUSING:**

Use a clean, damp cloth to wipe the exterior of the compressor housing.

**MAINTENANCE AND REPAIR:**

Never operate the nebulizer if it is improperly or incompletely assembled, or damaged. Use only our genuine parts, accessories, tubing and attachments for the nebulizer.

Use of other parts, accessories, tubing and attachments may damage the nebulizer or cause improper function. Do not open or disassemble the compressor unit at any time. This action will void the warranty. Repairs, service and maintenance should be carried out only by us authorized technician from Equinox.

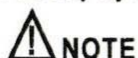
**NOTE**

There are no user serviceable parts inside this nebulizer. Service by anyone other than authorized serviceman voids the warranty from Equinox.

**10. NEBULIZER SPECIFICATIONS**

Power	230V, 50Hz
Power Consumption	68 Watts
Nebulizer Rate	0.5 $\mu$ m - 5 $\mu$ m
Medication Cup Capacity	6 ml (cc) max
Appropriate Medication Quantities	2 - 6 ml (cc)
Operating Temperature / Humidity	+ 10°C to 40°C, 30% to 85% RH
Storage Temperature / Humidity	- 20°C to 70°C, 10% to 95% RH
Weight	1800 gm
Operation Cycle:	Operation for 30 min. Off for 10 min.

---

## **11. LIMITED WARRANTY**

We offer a limited 18 months warranty on the compressor unit and accessories are to be replaced within 15 days if broken or faulty from the date of purchased. This warranty does not extend to failures resulting from accident, misuse, abuse, alteration, use of unauthorized service, parts, or cleaning solutions, or failure to comply with **User Manual**. If the warranted equipment should fail during the warranty period, we, at our option, will repair or replace parts at issue, provided the claim is bona fide. It shall be the responsibility of the purchaser to pack and return the equipment in a manner to avoid shipping damage. The shipment must be prepaid to us. This warranty covers the cost of labor incurred in the removal or replacement of the warranted component parts at us only. THERE ARE NO OTHER EXPRESS WARRANTIES, ALL IMPLIED WARRANTIES ON THE NEBULIZER AND ITS PARTS, INCLUDING IMPLIED WARRANTIES OF MERCHANTABILITY AND FITNESS FOR A PARTICULAR PURPOSE, ARE LIMITED TO EIGHTEEN MONTHS FROM THE DATE OF FIRST RETAIL PURCHASE. ALL EXPRESS OR IMPLIED WARRANTIES ON ANY OTHER PARTS, INCLUDING THE IMPLIED WARRANTIES ON ANY OTHER PARTS OF MERCHANTABILITY AND FITNESS FOR A PARTICULAR PURPOSE, ARE DISCLAIMED. Some states do not allow limitations on how long an implied warranty lasts, so the above limitations may not apply. The sole and exclusive remedy under this warranty is to repair or replace the this NEBULIZER and/or its parts at the option of us. IN NO EVENT SHALL US BE LIABLE FOR INCIDENTAL OR CONSEQUENTIAL DAMAGES TO THE PURCHASER OR ANY THIRD PARTS, INCLUDING WITHOUT LIMITATION, DAMAGES ARISING FROM LOST PROFITS, LOSS OF BUSINESS OPPORTUNITY, LOSS OF PROPERTY, ECONOMIC CLOSSES, OR STATUTORY OR EXEMPLARY DAMAGES WHETHER IN NEGLIGENCE, WARRANTY, STRICT LIABILITY OR OTHERWISE, Some states do not allow the exclusion of incidental or consequential damages, so the above limitations or exclusions may not apply to you. this warranty gives you specific rights. you may also have other rights, which vary state to state.

## **12. SERVICE AND REPAIR**

If you have any questions about this Nebulizer:

1. Please contact us on the address mentioned below.
2. In writing, describe the malfunction or symptoms of the product. Include your full name, address, and daytime contact telephone number. For tubing and accessories, clean, disinfect, and/or sterilized prior to returning. Dry the Nebulizer unit and place in a plastic bag.
3. Send the written description and the product in a protective box to the address provided by us in case there is a replacement required.

Manufactured By Equinox Meditech Pvt. Ltd  
Plot H-1/722 Samtal Zone,  
RIICO Industrial Area, Bhiwadi,  
Dist-Alwar-301019, Rajasthan

---

# equinox

Uploaded by [www.heyzindagi.in](http://www.heyzindagi.in)

## **Equinox Overseas Pvt. Ltd.**

FA-308, Mansarovar Garden  
New Delhi-110015

Phone - +91 011 46051516

Email-support@equinox-india.com

---



