



**G-ULTRA** 

# G-ULTRA TECHNICAL MANUAL



# Company Profile



**In-house  
R&D  
development  
team**

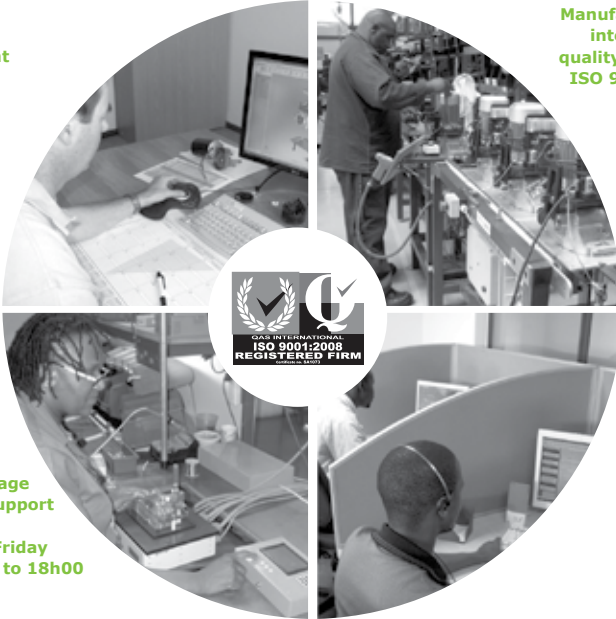

**Manufactures to  
international  
quality standard  
ISO 9001:2008**

**After-sales  
multi-language  
Technical Support**

**Monday to Friday  
from 07h00 to 18h00  
GMT+2  
Saturdays  
08h00 to 16h30 GMT +2**

**100%  
testing of  
products**



**Sales and technical support  
to Africa, Europe, Asia,  
the Americas, Australia  
and the Pacific**

**Centurion Systems (Pty) Ltd** reserves the right to make changes to the products described in this manual without notice and without obligation to notify any persons of any such revisions or changes. Additionally, **Centurion Systems (Pty) Ltd** makes no representations or warranties with respect to this manual. No part of this document may be copied, stored in a retrieval system or transmitted in any form or by any means electronic, mechanical, optical or photographic, without the express prior written consent of **Centurion Systems (Pty) Ltd**.



# Contents

<b>1. INTRODUCTION</b>	<b>PAGE 9</b>
<b>1.1. System Network Basics</b>	<b>Page 9</b>
1.1.1. G-Network of Devices	Page 10
1.1.1.1 Scenario 1	Page 10
1.1.1.2 Scenario 2	Page 10
1.1.1.3 Scenario 3	Page 10
<b>2. G-ULTRA UNIT</b>	<b>PAGE 12</b>
<b>2.1. Opening the Box</b>	<b>Page 12</b>
<b>2.2. Unit Description</b>	<b>Page 12</b>
2.2.1. Technical Specifications	Page 12
2.2.2. Terminal Block	Page 13
2.2.2.1 Power Supply	Page 13
2.2.2.2 Battery Backup	Page 14
2.2.2.2.1. Which Battery to Choose	Page 14
2.2.2.2.2. Wiring Up the Battery	Page 14
2.2.3. Inputs / Outputs	Page 15
2.2.3.1 Working With IO	Page 15
2.2.3.1.1. Steps to Configure	Page 15
2.2.3.1.2. Rise and Fall Edges	Page 15
2.2.3.2. Working with Relays	Page 16
2.2.3.2.1. Latching VS Pulsed	Page 16
<b>2.3. Network Connectivity</b>	<b>Page 16</b>
2.3.1. Network Access from the Mobile Apps	Page 16
2.3.2. SIM Card	Page 17
2.3.2.1.Replacing the SIM Card	Page 17
2.3.3. Alternative Network SIMs	Page 17
2.3.4. Checking or Replacing the SIM Card	Page 17
2.3.4.1. SIM Card Maintenance	Page 18
2.3.4.2. How to Remove the SIM Card	Page 18
2.3.4.3. How to Insert the SIM Card	Page 18
<b>2.4. Installing the G-ULTRA</b>	<b>Page 19</b>
2.4.1. Unit Disassembly	Page 19
2.4.2. Mounting the Unit	Page 20
<b>2.5. Powering Up the G-ULTRA</b>	<b>Page 20</b>
<b>2.6. Configuring Features</b>	<b>Page 21</b>
<b>3. LCD INTERFACE</b>	<b>PAGE 22</b>
<b>3.1. Home Screen</b>	<b>Page 22</b>

<b>3.2. IO Status Screen</b>	<b>PAGE 23</b>
<b>3.3. Output Status Screen</b>	<b>Page 23</b>
<b>3.4. Voltage / Firmware / Date &amp; Time Screen</b>	<b>Page 24</b>
<b>3.5. Phone Number Screen</b>	<b>Page 24</b>
<b>3.6. Airtime Balance Screen</b>	<b>Page 25</b>
<b>3.7. GSM Antenna Selected Screen</b>	<b>Page 25</b>
<b>3.8. Gate Status Screen</b>	<b>PAGE 26</b>
<b>3.9. SIM Screen</b>	<b>Page 26</b>
<b>3.10. IMEI Screen</b>	<b>Page 26</b>
<b>4. WIRING DIAGRAMS</b>	<b>PAGE 27</b>
<b>4.1. Gate Status Monitoring</b>	<b>Page 27</b>
<b>4.2. Gate Trigger Pulse</b>	<b>Page 28</b>
<b>4.3. Wiring the G-ULTRA into a D-Series Controller</b>	<b>Page 29</b>
<b>4.4. Wiring the G-ULTRA into an Electric Fence</b>	<b>Page 30</b>
<b>4.5. Wiring a G-ULTRA into an Alarm System</b>	<b>Page 31</b>
<b>4.6. Wiring a G-ULTRA into a D-Series Controller via a Wizo</b>	<b>Page 32</b>
<b>4.7. Wiring a G-ULTRA into an Electric Fence Controller via WiZo-Links</b>	<b>Page 33</b>
<b>4.8. Wiring a G-ULTRA into an Alarm System via WiZo-Links</b>	<b>Page 34</b>
<b>5. G-WEB</b>	<b>PAGE 35</b>
<b>5.1. Introduction to G-WEB</b>	<b>Page 35</b>
<b>5.2. G-WEB Online</b>	<b>Page 35</b>
5.2.1. Login / Create an Account	Page 35
5.2.2. G-WEB Dashboard	Page 36
5.2.2.1. Wallet	Page 36
5.2.2.2. My Devices	Page 36
5.2.2.2.1. Navigating the Device Listing	Page 37
5.2.2.2.2. Add Funds	Page 38
5.2.2.2.3. Add New Device	Page 38
5.2.2.2.4. Synchronise / Synchronise Selected	Page 39
5.2.2.2.5. Delete Selected Devices	Page 39
5.2.2.2.6. Clone Selected Device	Page 39
5.2.2.2.7. My Recharges	Page 40
5.2.2.2.8. Device Token Top-up	Page 40

5.2.2.3. My Profile	Page 40
5.2.2.3.1. Personal Details	Page 40
5.2.2.3.2. Change Password	Page 41
5.2.2.3.3. Security Settings	Page 41
5.2.2.3.4. Notification Settings	Page 42
View Wallet Statement	Page 42
Company Details	Page 43
Time Zone	Page 43
5.2.2.4. My Contacts	Page 44
5.2.2.4.1. Add Contact	Page 44
5.2.2.4.2. Delete Selected	Page 44
5.2.2.4.3. Edit Custom Fields	Page 45
5.2.2.4.4. Managing the Contact List	Page 45
Edit an Existing Number	Page 45
Delete a Single Number	Page 45
5.2.2.4.5. Export Contacts	Page 46
5.2.2.4.6. Import Contacts	Page 46
5.2.2.5. Support	Page 46
5.2.2.6. Logout	Page 47
5.2.3. Managing and Configuring Individual Devices	Page 47
5.2.3.1. Status	Page 47
5.2.3.1.1. Device Status	Page 47
Connection Information	Page 47
Sync Details	Page 48
General Information	Page 48
Device Token Remaining	Page 49
5.2.3.1.2. Logs	Page 49
Export Log Data	Page 50
Sync Logs, Refresh	Page 50
Delete, Delete All	Page 51
5.2.3.2. Access Configuration	Page 51
5.2.3.2.1. Access Numbers	Page 51
Import Numbers	Page 51
Updating the Access Numbers with the Template	Page 52
Export Numbers	Page 52
Add Access Number	Page 53
Add Access Number From Contact List	Page 53
Delete Selected Numbers	Page 54
Edit Selected Numbers	Page 54
Device Welcome Message	Page 55
Edit the Welcome Message	Page 55
5.2.3.2.2. Access Profile	Page 55
5.2.3.2.3. How to Add a Profile	Page 56
5.2.3.2.4. How to Edit a Profile	Page 56
5.2.3.2.5. Activations	Page 56

	G-REMOTE	Page 57
	Configure Visible IO	Page 57
	Calls (DTMF / Missed Call)	Page 58
5.2.3.2.6	Notifications	Page 59
5.2.3.2.7	Notification Settings	Page 59
	Global Device Outgoing Notification Messages	Page 59
	Input Trigger Outgoing Notification	Page 59
	Output Trigger Outgoing Notification	Page 60
	Device Offline Notifications	Page 60
	System Outgoing Notifications	Page 61
5.2.3.2.8	Enable / Disable Access Profiles	Page 61
5.2.3.2.9	Delete Access Profile	Page 61
5.2.3.2.10.	Profile Activity Notifications (Recurring)	Page 61
	Add Notification	Page 62
5.2.3.2.11.	Profile Activity Notifications (Once Off)	Page 63
	Messages	Page 63
5.2.3.3.	Settings	Page 64
5.2.3.3.1.	IO Settings	Page 64
	Configure an IO	Page 65
	Enable Gate Status Monitoring	Page 65
	Configure an IO (relay)	Page 65
5.2.3.3.2.	Advanced IO Settings	Page 66
	Falling and Rising Edge Settings	Page 66
	How to Set Falling Edge / Rising Edge	Page 67
	Configuring Output Channels	Page 67
5.2.3.3.3.	Time Window	Page 68
	Add a Time Window	Page 68
	Edit A Time Window	Page 69
	Enable / Disable A Time Window	Page 69
	Delete A Time Window	Page 69
5.2.3.3.4.	IO Mappings	Page 69
	Add an IO Mapping	Page 69
	Edit an IO Mapping	Page 70
	Delete an IO Mapping	Page 71
5.2.3.3.5.	Output Activation Schedule	Page 71
	Add Output Schedule	Page 72
5.2.3.3.6.	Exclusion Dates	Page 73
5.2.3.3.7.	Advanced Power Settings	Page 74

## 5.3. G-WEB App

Page 74

5.3.1.	Installation	Page 74
5.3.2.	Adding a Device	Page 74
5.3.3.	Device Options	Page 75
5.3.3.1.	Configure Device	Page 75
5.3.3.1.1	Back	Page 75

5.3.3.1.2	Info	Page 75
	Device Details	Page 75
	Connectivity Details	Page 76
	Device Tokens Remaining	Page 76
	Firmware Details	Page 76
5.3.3.1.3.	Access Numbers	Page 77
5.3.3.1.4.	Access Profiles	Page 77
	Adding a New Profile	Page 77
	Editing the Profile	Page 77
	Disable / Enable	Page 78
	Delete a Profile	Page 78
5.3.3.1.5.	Sync	Page 78
5.3.3.1.6.	Logs	Page 78
5.3.3.1.7.	Settings	Page 78
	IOs	Page 78
	Configure IO	Page 79
	Configure a relay output	Page 79
	Configure A Button	Page 80
	Disable / Enable	Page 80
	IO Mapping	Page 80
	Editing / Deleting IO Mapping	Page 81
	Power Saving	Page 81
5.3.3.1.8.	Scheduled Activations	Page 81
5.3.3.1.9.	Exclusion Dates	Page 82
5.3.3.1.10.	SMS Commands	Page 82
	How to Send Commands	Page 82
5.3.3.1.11.	Time Periods History	Page 83
	How to Add a Time Period	Page 83
5.3.3.1.12.	History Logs	Page 83
5.3.3.1.13.	Support	Page 83
5.3.3.2.	Wizard	Page 83
	5.3.3.2.1 Device Application Wizard	Page 84
5.3.3.3.	Clone Device	Page 85
5.3.3.4.	Transfer Device	Page 85
5.3.3.5.	Add Secondary User	Page 85
5.3.3.6.	Delete Device	Page 86

## 6. G-REMOTE

Page 86

### 6.1. Introduction

Page 86

### 6.2 Installing the App

Page 86

### 6.3 Using G-REMOTE

Page 86

6.3.1.	G-REMOTE Landing Page / Favourites List	Page 86
6.1.3.1.1	<b>G-ULTRA</b> Device Landing Page	Page 87
6.3.2.	Using and Customising Buttons	Page 87
6.3.2.1.	Activating the Button	Page 87

6.3.2.2.	Deactivate the Button	Page 87
6.3.2.3.	Add to Favourites	Page 87
6.3.2.4.	Enter a Name for the Button	Page 88
6.3.2.5.	Change the Button Colour	Page 88
6.3.2.6.	Change Icon	Page 88
6.3.3.	Input Actions	Page 89
6.3.4.	Device Notifications	Page 89
6.3.5.	Information	Page 89
6.3.5.1.	Device Info	Page 89
6.3.6.	Send Commands	Page 90
6.3.6.1.	How to Send Commands	Page 90
6.3.7.	Settings	Page 90
6.3.7.1.	All Devices	Page 90
6.3.7.2.	Selected Device	Page 91
	How to Change Notification Type	Page 91
6.3.8.	Refresh Permissions	Page 91
6.3.9.	About	Page 91

## 7. TROUBLESHOOTING Page 92

### 7.1. My Device is Not Connected to G-WEB Page 92



This icon indicates tips and other information that could be useful during the installation.



This icon denotes variations and other aspects that should be considered during installation.



**This icon indicates warning, caution or attention! Please take special note of critical aspects that MUST be adhered to in order to prevent injury.**



# 1. Introduction



The **G-ULTRA** is a remote monitoring and control system which is GSM-enabled. Leveraging the power of GSM, the unit is capable of monitoring and / or controlling a variety of systems and devices using a mobile device.

One or more **G-ULTRA** devices can be linked using G-WEB, Centurion Systems's online system that enables the user to group their **G-ULTRAS**, configure and manage them, and purchase airtime.

GSM is an established and inexpensive technology, and the **G-ULTRA** leverages the many benefits of its reliability to produce a flexible, mobile-based access control and monitoring system.

## 1.1. System Network Basics

As shown in the image below, the **G-ULTRAS** require cellular network access. **G-ULTRAS** can be set up at the same location, e.g. a home or business, or at different locations and yet still be controlled, and monitored via the same mobile device in tandem with G-WEB.



It is essential to perform a network coverage check at the installation location to ensure that network coverage is available and that if the **G-ULTRA** requires an antenna it is installed. Since many factors impact network coverage, this is a best-effort approach to connectivity and poor or intermittent network coverage may impact system operation.

Since the **G-ULTRA** is GSM-enabled, i.e. includes a built-in GSM modem, the unit requires a SIM card. The network provider for the **G-ULTRA** unit is MTN (South Africa only). Using MTN's extensive network, the **G-ULTRAS** can be configured, monitored, managed and airtime purchased for their operation. "Airtime", referred to as tokens, are required to ensure that the **G-ULTRA** stays connected to the network. These are available via G-WEB.

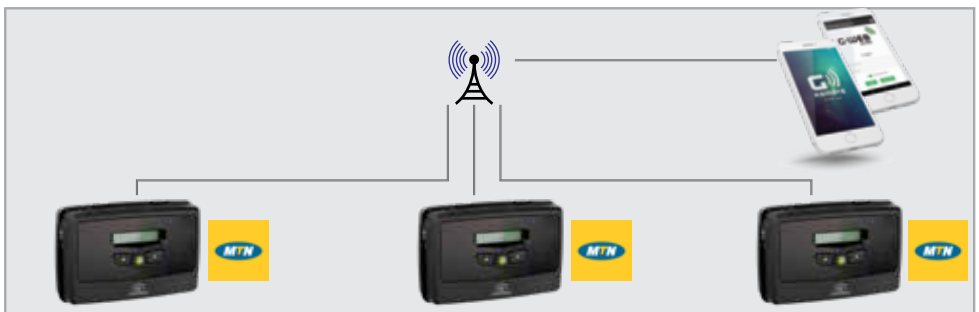

FIGURE 1.



Between the mobile device controlling the **G-ULTRAS** and the cellular network, this path is network agnostic; it does not matter which network is used. However, between the **G-ULTRA** and the cellular network, this is MTN network centric.

### 1.1.1.1. G-Network of Devices



The following information is conceptual and will define and describe some options users have to create G-Networks.

In the scenarios described below, two applications are used to operate and configure a G-Network: these are G-WEB, for configuration and G-REMOTE for operating and interacting with the **G-ULTRA**. Only one instance of G-WEB would be needed or required to create a network of devices, and multiple users would be able to control or interact with the network.

Depending on the user, they can also have access to multiple networks of devices. Devices do not necessarily need to be located at the same premises and therefore can be anywhere within South Africa. The two scenarios are for illustrative purposes and do not limit the product in any way; they are intended to assist in conceptualising the usage potential.

#### 1.1.1.1.1. Scenario 1

Frank is on the board of trustees, and he is the complex maintenance coordinator. They recently installed a CENTURION D-Series Gate Operator, the **G-ULTRA**, and other CENTURION products. He installed the G-WEB app on his phone and used G-WEB to configure the complex security gate to allow the opening and closing of the gate remotely. He then installed the G-REMOTE app on his phone, and he tested the operation using G-REMOTE. Since he was happy with the operation, he instructed the residents to install G-REMOTE. He already had their numbers, so he added them as Users and enabled them to activate the gate.

The complex residents then installed G-REMOTE and were able to immediately open and close the gate using their phone.

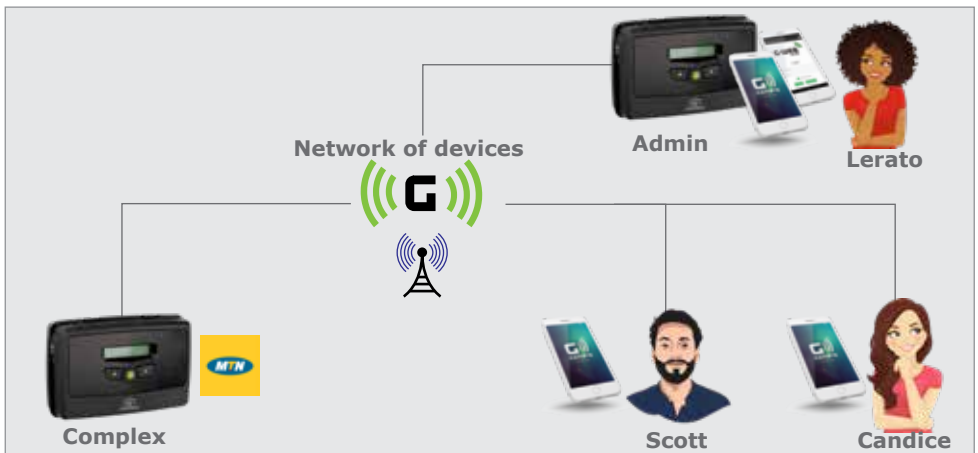

FIGURE 2.

### 1.1.1.2. Scenario 2

Candice lives in the same complex as Lerato. Recently, there had been security issues with the old system, and she was happy to hear that a new system was being installed. She received a link on WhatsApp directing her to install an app galled G-REMOTE. She tapped on the link, found herself in the AppStore, and then clicked install. Once the G-REMOTE app was installed, she opened it, clicked on the name of her complex on the main screen, and saw a collection of large, easy to read colour-coded buttons. Just then, her mom messaged her from the gate, and she tapped the easy to see Open Gate button and could see from her lounge window, the gate opening.

### 1.1.1.3. Scenario 3

Lerato and Candice were impressed with the way that the new CENTURION products had improved security at their complex. They decided to install a similar setup at their small business premises. Thinking it would be difficult, they approached Frank and asked for help. He said there was no need, as all they needed to do was to install the G-WEB app on their phone, follow the easy instructions to link the new device, and then to also link their phone to their G-WEB profile. He then showed them how to link the new, separate **G-ULTRA** device so that it displayed in G-REMOTE.

Dumisani spends more time out of the office, and now Candice can open and close the gate from her phone. During the day, it has been very convenient to let clients and suppliers in and out of the premises as the old wired system kept breaking especially after a lightning storm. Now, the quick response of the remote system has made it easy and she can open it from wherever she is, as she does not need to go to the front of the office to press a button.

It also proved very useful over the weekend when the armed response security needed to gain entry to the premises, and they were able to 1) open the gate 2) wait on the response that the alarm had been reset 3) were able to monitor the gate closure remotely until closed.

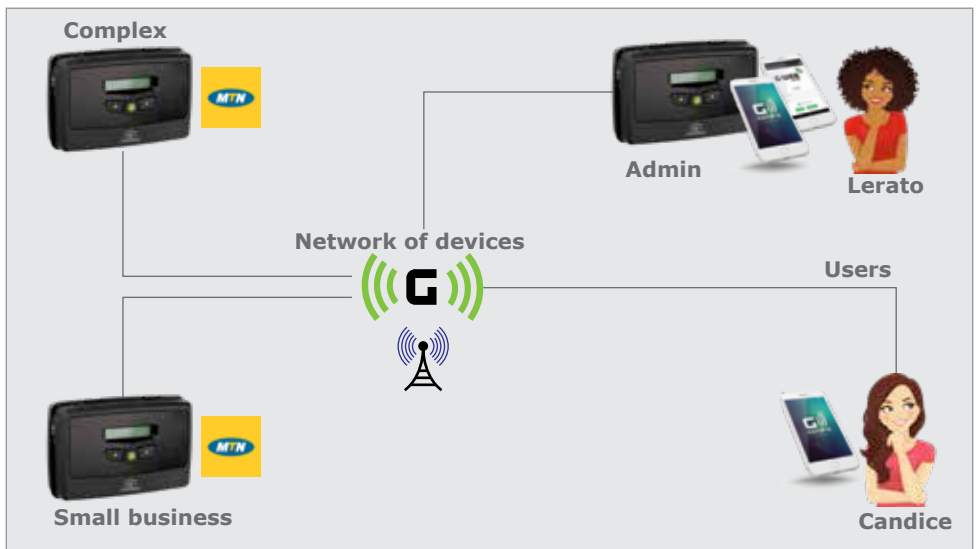

FIGURE 3.

## 2. G-ULTRA UNIT

### 2.1. Opening the Box



The following details pertain to the **G-ULTRA**; ensure to make note of the items mentioned.

Before opening the box, you will notice on the side of the box key information you will require later. They are the following items:

- IMEI Number; this uniquely identifies the GSM unit
- Password: this is a 4-digit number that is already configured for the device

Ensure that the flap of the box is retained or that you record the information using your phone by taking a picture or by recording the information by other means.

### 2.2. Unit Description

The unit is compact but releases easily from the box once you carefully cut through the tamper-proof seal that protects both sides of the box. If this seal is compromised, return your purchase.

#### 2.2.1. Technical Specifications

The following specifications describe the Key Features and operating Requirements for the **G-ULTRA**.

Item	Description
Supply Voltage Range	11-24V DC
Maximum Current Draw	300mA @ 12V DC
Input/output Current Rating	50mA (Open Collector)
Relay Contact Current Rating	1A, 30V AC/DC (Resistive)
Input Sense Voltage Range	0-24V DC (0-1.6V Low-input State, 5V-24V High-input State)
Network Provider	MTN (South Africa only)
Number of Configurable IO Channels	4
Number of Relays	2 <sup>1</sup>

**TABLE 1.**

1. A relay will allow for a higher current load to be switched on using the **G-ULTRA**

### 2.2.2. Terminal Block

Shown here are the Terminal Block connections for **G-ULTRA**. You gain access to the terminal block by removing the cover, which lifts free from the unit's base

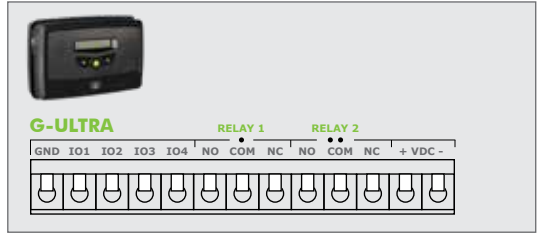

FIGURE 4.

GND	Ground
IO1	Input / Output 1 (Default: Output)
IO2	Input / Output 2 (Default: Output)
IO3	Input / Output 3 (Default: Output)
IO4	Input / Output 4 / Gate Status Input (Default: Output)
NO	Relay 1 Normally-open
COM	Relay 1 Common
NC	Relay 1 Normally-closed
NO	Relay 2 Normally-open
COM	Relay 2 Common
NC	Relay 2 Normally-closed
+	Positive of Power Supply 12-24VDC
-	Negative of Power Supply

TABLE 2.

#### 2.2.2.1. Power Supply

The **G-ULTRA** utilises a DC (Direct Current) power supply, with an acceptable input range from 11 Volts DC to 24 Volts DC. The **G-ULTRA** can therefore be powered by a battery of suitable output, or suitable DC Power supply.



- Ensure sufficient input voltage is supplied so that the **G-ULTRA** powers up correctly
- Do not oversupply the **G-ULTRA** as this WILL damage the unit
- DO NOT power the unit directly from an Alternating Current (AC), Mains, or normal household socket supply as this WILL destroy the **G-ULTRA**

The common standard for wire colours for a DC connection is red and black: red positive and black negative. Following this wiring convention will make the connections simpler, and 2-core cabling is readily available using this scheme.

Shown left is the power connections which need to be active to be able to sync the **G-ULTRA** device.

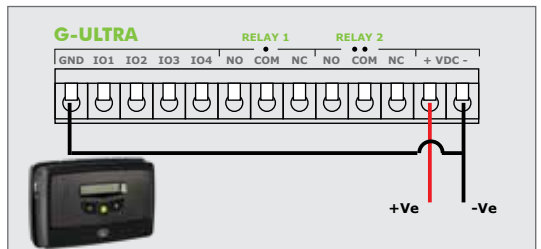

FIGURE 5.

### 2.2.2.2. Battery Backup

The **G-ULTRA** can be powered from a battery backup system in the event of a power failure, and this can be tied into the Advanced Power features. You have the choice of two options to power either from a 12V or a 24V battery, and this is within the DC power supply range of the device.

#### 2.2.2.2.1. Battery Backup

The battery often used for a **G-ULTRA** is a standard 12V 7 Ah, sealed lead-acid battery. These are often used in UPS (Uninterruptible Power Supply) and are inexpensive and readily available.

With the range of batteries, the Ampere Hour or Ah rating does correlate to the physical size of the battery and for how long the **G-ULTRA** could be powered. The **G-ULTRA** draws 300 mA at 12V, so  $7 \text{ Ah} / 300\text{mA} = 23.3$  hours. Your **G-ULTRA** in theory would then have close to 24 hours running time during load shedding, for example. This time is theoretical, as the condition of the battery and other factors can impact on the battery, reducing the time it can be a backup.



FIGURE 6.

#### 2.2.2.2.2. Wiring Up the Battery

As shown in the image below, the battery is connected in line with the **G-ULTRA** and therefore it charges and is part of the power circuit at the same time. Good practice would be to include a diode in-line with the positive wiring before the battery and after the power supply. Charge voltage for a SLA is 13.7V, so to compensate for the diode which needs 0.6V to work, your total input voltage would be 14.3V. The reason for the diode is that, while the power supply is active, it is providing power but when there is a power failure, the power supply can effectively become a load and help drain the battery. The diode protects the battery and ensures that only the **G-ULTRA** is using it.

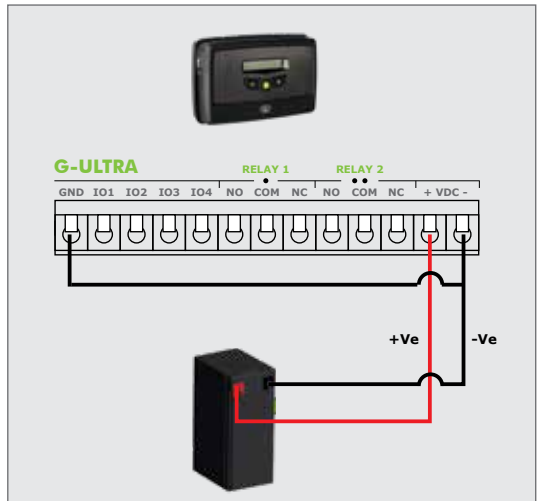

FIGURE 7.



When the battery is included, strict adherence to the maximum input voltage must be applied to avoid overcharging the battery. If overcharged, this can lead to excessive heat and a potential fire hazard.

### 2.2.3. Inputs / Outputs

The **G-ULTRA** offers four individually-configurable channels (IO) and two Relay Outputs can be mapped to either trigger a notification or activate an output. These are configured using the G-WEB application or website.



Input 4, is a dual-purpose input that can be assigned to monitor the condition or state of a gate operator of a gate closing. Only Input 4 can be assigned to this role, and a D-Series Motor controller is used to provide the input data. Input 4 is configured using the G-WEB application or website. If more than one gate needs to be monitored, then two **G-ULTRAS** would be required

#### 2.2.3.1. Working With IO

The **G-ULTRA**'s IO are highly configurable and enable the user to map them internally to either the IO's located at positions 1-4 or the mechanical relays at relay output 5 and 6. An input can be configured as a trigger to an output. This can be as simple as a push button interaction, for example, a security office pushing a button in an office to open a gate or to buzz a door open.

##### 2.2.3.1.1. Steps to Configure

Configuring an input has two main steps; the first is to configure an IO as an input, which is done on the IO settings page. The second step, once the IO has its designation, is to configure the advanced features of the IO on the Advanced IO settings page.

##### 2.2.3.1.2. Rise and Fall Edges

Rise Edge refers to the time it takes for the leading edge of a pulse (voltage or current) to rise from its minimum to its maximum value. Rise Edge is typically measured from 10% to 90% of the value. Conversely, Fall Edge is the measurement of the time it takes for the pulse to move from the highest value to the lowest value. In a resistive circuit, Rise Time values are primarily due to stray capacitance and inductance, which cause a delay in voltage and/or current until the steady state is reached. In terms of application, when measuring a waveform on an oscilloscope, the faster the Rise Edge, the more accurate the measurement.

When using the Rise and Fall elements of an input pulse, it is important to consider how this may affect the day-to-day operation of the system, and how you wire the push button in, for example. The two ways would be to:

1. Wire a push button so that it's normally-closed i.e. there is always power active on the input until the push button is pressed. The power then goes from high to low or has a falling edge, i.e. on to off
2. Alternatively, the push button is wired so that the power is only present on the input when the push button is pushed, and so has a rising edge i.e. off to on

In an ideal world, we would have clean signals moving between the switch and the input, but in the real world owing to electrical characteristics of materials, transient power surges and interference, any number of events can appear like a valid input signal, but it is not. As shown in the image below, what is anticipated by us in the ideal world is offset by what may happen and a poorly formed input signal may be valid or just interference.

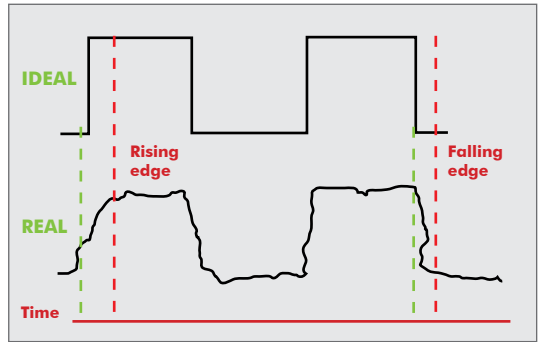

FIGURE 8.

### 2.2.3.2. Working with Relays

A relay is a mechanical component that can be triggered to switch a device on or off depending on how it is set up and wired.

#### 2.2.3.2.1. Latching VS Pulsed

A relay is a mechanical component that can be triggered to switch a device on or off depending on how it is set up and wired.

An example is where the **G-ULTRA** is used to switch a pump on, and it stays on until the float mechanism triggers the **G-ULTRA** to switch the relay off.

Pulsed, is the change from the current state to a new state momentarily or for a short time and then automatically switches back to the original state.

An example would be a day-night switch, where the motion sensor triggers the relay, but it only stays on for a few seconds or minutes before switching off regardless of whether the action which caused the trigger is still active.

## 2.3. Network Connectivity

### 2.3.1. Network Access from the Mobile Apps

Mobile apps have been provided without cost, and these apps enable you to configure and use a configured device. When you use the mobile apps for monitoring and configuring the device, no costs to you are incurred for the life of the product, provided that a CENTURION MTN SIM is used



CENTURION MTN SIM cards can only be recharged using the G-WEB online platform or G-WEB mobile app.

For costs incurred when making use of SMS notifications you will need to purchase CENTURION tokens via G-WEB



### 2.3.2. SIM Card

The unit is supplied with a NANO SIM card. The SIM card is visible when the top cover plate is removed, and the unit tipped to the side. The SIM card is held in place by a push to release the SIM cardholder.

The SIM card supplied is an MTN SIM card, which is contracted via CENTURION to MTN. The supplied SIM card is not standard and can only be used in the **G-ULTRA**, and other CENTURION products where applicable. It cannot be used in mobile phones or any other standard mobile device for communication purposes.

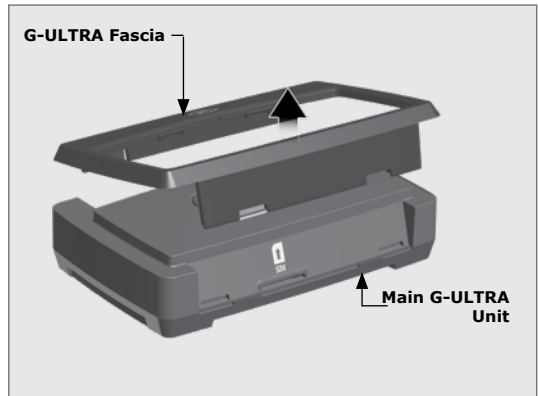

FIGURE 10.

#### 2.3.2.1. Replacing the SIM Card

When replacing the SIM card, ensure to detach the NANO SIM, which is the innermost detachable section as shown in the image.

Follow the instructions below to insert the SIM card.

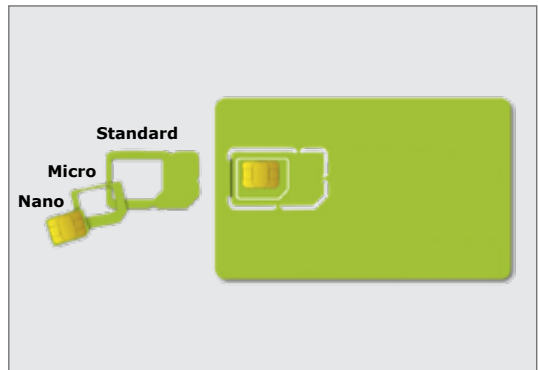

FIGURE 11.

#### 2.3.3. Alternative Network SIMs

The **G-ULTRA** has been supplied with a SIM which has been configured to work exclusively with the MTN network, and this offers many convenient features when recharging the SIM with tokens. The **G-ULTRA** is not a networked locked device, and you can remove the supplied SIM and use a SIM supplied by any of the local South African networks. If an alternative SIM is used, you will still be able to configure the unit using G-WEB; however, managing the device's airtime and network access won't be available and will have to be managed externally.

## 2.3.4. Checking or Replacing the SIM Card

### 2.3.4.1. SIM Card Maintenance

Under normal circumstances, the SIM card should function indefinitely provided the **G-ULTRA** is not subjected to a harsh environment. Harsh environments are ones where the **G-ULTRA** is exposed to dust, corrosive chemicals either directly or indirectly through atmospheric exposure or environments where there is a high degree of static and/or electrical interference.

However, in the event that the **G-ULTRA** loses connectivity, and the SIM card is suspected, the SIM card can be removed and cleaned or replaced. Cleaning would involve using a normal eraser to remove any carbon or particle build-up. If this does not solve the connectivity issue, the SIM card may need to be replaced.

Please follow the instructions in the next section on removing and replacing the SIM card.

### 2.3.4.2. How to Remove the SIM Card

Removing the SIM card, when required, is performed by doing the following:

1. Power down the **G-ULTRA**, then attempt the SIM removal
2. Using the closed edge of a tweezer, press against the flat edge of the SIM card. Apply firm, even pressure
3. A very slight click will be heard and then the SIM card will release
4. Once ejected, use a pair a tweezers to remove from the slot

### 2.3.4.3. How to Insert the SIM Card

Inserting the SIM card, when required, is performed by doing the following:

1. Ensure that the SIM card is orientated correctly. Use the monogrammed image on the chassis
2. Using a pair of tweezers, insert the SIM card into the slot
3. Using the closed edge of the tweezers along the flat edge of the SIM card, push the SIM card down using firm, even pressure until you feel resistance. If a slight click is felt and/or heard, then the SIM card is secure
4. Release the pressure from the SIM card and it should now remain in the slot
5. Visually inspect the inserted SIM card and ensure that it has been securely inserted
6. Power up the **G-ULTRA**

## 2.4. Installing the G-ULTRA

Installing the **G-ULTRA** requires some degree of technical skill working with tools to mount the unit onto a solid surface of differing materials. It is advisable to defer mounting the unit to either trained or experienced personnel if you do not possess the appropriate know-how.

### 2.4.1. Unit Disassembly

The **G-ULTRA** has been designed with quick disassembly and installation in mind. As can be seen, the **G-ULTRA** unclips into three separate pieces.



FIGURE 12. PRODUCT IDENTIFICATION

1. Fascia
2. External Antenna Cover
3. Main **G-ULTRA** Unit
4. Mounting Plate
5. Terminal Blocks
6. Navigation panel
7. LCD Screen



While the **G-ULTRA** is constructed from quality and durable materials, the unit or its components should not be subjected to an environment of temperature extremes, highly corrosive chemicals, or noxious environments.

### 2.4.2. Mounting the Unit

With the mounting plate removed, you will notice many mounting positions molded into the plate.

For ease of installation, we recommend that you use the mounting plate as a template to mark off the mounting positions.

1. Identify a suitable location for the **G-ULTRA**, and ensure that the unit will not be mounted in the path of any sources of water, condensation, or mold.
2. Using the mounting plate as a template, mark off the holes using a pencil or a sharp object which will leave a visible mark on the wall or the surface where the unit will be mounted. Ensure that the plate is facing the correct way i.e. square slot down, as shown in the image below.
3. Remove the mounting plate from the surface and use the appropriate size drill to create the mounting holes.
4. Once the holes have been drilled, secure the mounting plate to the surface and ensure the mounting plate is sitting flush against the wall.
5. The main **G-ULTRA** unit can now be clipped back into the mounting plate.

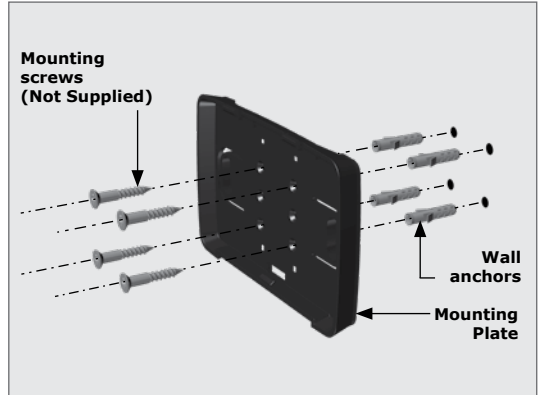

FIGURE 13.



FIGURE 14.



It is not advised that you drill directly through the mounting plate as this may damage the plate, especially if a mortise drill bit is used.

With the unit now securely mounted, you can proceed with wiring up the unit.

### 2.5. Powering Up the G-ULTRA

Please see the following section: Power Supply, for details on the power connections.

To power up the unit, supply the required minimum power to the **G-ULTRA** and the LCD screen will switch on displaying the words "**G-ULTRA**" and the CENTURION logo. This is the startup screen, and this will be displayed for roughly 10 seconds, and then the Home Screen will display.

The Home Screen will light up using the LCD backlight and after a short while the backlight will switch off. The LCD Interface enables you to view the current status of the **G-ULTRA**; however, it does not allow you to configure any features from the **G-ULTRA** itself.

To configure the **G-ULTRA**, you require one of the following:

1. A PC or Laptop with a stable Internet connection
2. A Mobile phone running either Android (Non-brand specific or IOS (iPhone)
3. An Android device or an IOS device



Old style mobile devices which are not smartphones will not support the mobile app.

## 2.5. Configuring Features

Apps work together to enable the **G-ULTRA** to be configured and controlled. G-WEB which is available as a website and also as an app for your mobile device, G-REMOTE, which enables authorised users to activate and monitor one or more **G-ULTRAS**.

G-WEB is therefore the administrative application, and G-REMOTE would normally be used by an end-user. For example, in a Residential Complex, G-WEB would be used to configure the gate access control and then G-REMOTE would be used by the residents to open the gate to gain entry.



FIGURE 15.

## 3. LCD INTERFACE









The **G-ULTRA** employs a user-friendly and concise menu system which is operated from the unit's keypad. The LCD (Liquid Crystal Display) enables the user to navigate through many different screens that will display the system's status and system settings.

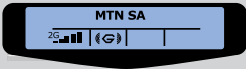

**G-ULTRA** system settings and configuration are done using G-WEB, and to activate or use these features G-REMOTE is used.

### 3.1. Home Screen

The Home Screen is the default screen and is displayed once the device has powered up.

HOME SCREEN		
		Indicates network signal strength. Depending on network access, either a 2G or 3G indicator will appear
		Indicates connection to the internet; however, does not indicate a connection to G-WEB
		Indicates when a connection to G-WEB is active
		The device has an error
		Incoming or inbound message
		Outgoing or outbound message. This action consumes a token per event
		Incoming call events
		Outgoing Phone call events. This action consumes a token per event

**TABLE 3.**

### 3.2. Home Screen

The IO (Input / Output) are four user-configurable, bi-directional IO. This flexibility enables the user to determine how each of the four are used and to configure accordingly. Each IO can be either an input or an output. IO 4 has a special feature and has a third function as the input for the Gate Status monitoring.





IO STATUS SCREEN	
	 <p>When the circle is light, this indicates that the input is deactivated. The small "E" indicates that an input event has occurred, and no action takes place since the input is not active</p>
	 <p>When the circle is dark, this indicates that the input is activated.</p>
	 <p>The output is off.</p>
	 <p>The output is on*.</p>

TABLE 4.



For the IO, which excludes the available two mechanical relays, an input or output is considered active "on", high when pulled low.

### 3.3. Output Status Screen

The output status screen displays the status of the two mechanical relay outputs. Mechanical relays are usually used to switch a high-current/voltage load and should be used for this purpose.





OUTPUT STATUS SCREEN	
	 <p>For example, illustrates that the relay is in the Normally-Open position.</p>
	 <p>For example, illustrates that the relay is in the Normally-Closed position.</p>

TABLE 5.

### 3.4. Voltage / Firmware/ Date And Time

This menu indicates key operating conditions for the device

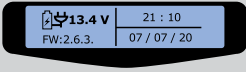
VOLTAGE / FIRMWARE/ DATE AND TIME	
	<p><b>Supply Voltage</b></p> <p>The Supply Voltage indicator is used to indicate the measured input Supply voltage. The value displayed will update at system power-up and update periodically but does not update dynamically if the input voltage changes suddenly or changes from one value to another</p>
	<p><b>Firmware</b></p> <p>The Firmware version number indicates the current revision of firmware installed on the <b>G-ULTRA</b>. This may differ from the version of firmware that is available. If the version is older i.e. version 2.4.9 is installed but 2.5.0 is available, this may indicate that 1) the device is performing a self-update 2) the Automatic Updates setting has been disabled 3) there may be insufficient credits in your account</p>
	<p><b>Time</b></p> <p>The time as provided by the cellular network. If daylight saving has been enabled, the time will display accordingly</p>
	<p><b>Date</b></p> <p>The Date and Time displayed is provided by the internal Real Time Clock. The regional setting for the time can be selected using G-WEB under Settings &gt; Clock Settings, configuring the regional setting and then syncing this to the <b>G-ULTRA</b></p>
	<p>This should not be viewed as a voltmeter as this is not its purpose. For this reason, a fixed voltage supply should be used and not a variable output supply to avoid either over- or under-supplying the <b>G-ULTRA</b></p>
	<p>Firmware updates are without charge; however, network access costs may apply.</p> <p>Day Light Saving as a feature is available and is configured in G-WEB under Settings &gt; Clock Settings and then syncing this to the <b>G-ULTRA</b>.</p>

### 3.5. Phone Number Screen

PHONE NUMBER SCREEN	
	<p>The phone number listed on the screen is the number assigned to the SIM card loaded on the <b>G-ULTRA</b>. This would be an MTN cell number, in international format; for example: +27XXXXXXXXXX. If the SIM card is changed, then the number will change automatically as well, and the new number will be displayed on the screen.</p>

TABLE 7.



### 3.6. Airtime Balance Screen

The airtime balance reports on the remaining balance airtime credits, credited to the **G-ULTRA** on the current SIM card.

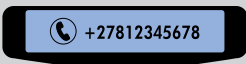

AIRTIME BALANCE SCREEN	
	 <p>The SIM card requires outgoing call credits or tokens. The balance is displayed here.</p>
	 <p>The SIM card requires outgoing SMS credits or tokens. The balance is displayed here.</p>

TABLE 8.

### 3.6. GSM Antenna Selected Screen

The default setting is to use the internal antenna, and this should be adequate for most applications where the **G-ULTRA** is located in an area which has average to good network coverage. If the **G-ULTRA** does not receive commands or takes a long time to send notifications, this may indicate that the network coverage is intermittent or poor and an antenna can be attached to compensate for this and assist in improving the reception.





GSM ANTENNA	
	 <p>Internal GSM antenna is selected (Default).</p>
	 <p>External GSM Antenna is selected.</p>
	 <p>Press enter to toggle between the internal / external antenna.</p>
	<p>If you change the Antenna selection on the <b>G-ULTRA</b>, ensure that when the external antenna is selected, one is attached. If one is not attached, you may experience network connectivity issues. This can only be changed at the <b>G-ULTRA</b> itself.</p>

TABLE 9.

#### 3.6.1. Change Antenna Settings

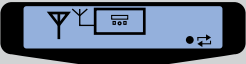
To change the antenna setting, do the following:

1. Using the scroll buttons, scroll to the Antenna menu, and press enter
2. Press the arrow keys to change and toggle antenna selection
3. Press enter again to save the change
4. The unit will display a countdown from 5 to 0, and display an hourglass Icon to indicate that the Antenna change is in progress

### 3.7. Gate Status Screen

The Gate Status screen displays the state of the gate assigned to IO4. This is configured using the G-WEB application, and the IO is assigned as a gate monitoring input. This configuration requires that a D-Series controller for example is in place, connected to the **G-ULTRA**, and has been configured to monitor the gate status.

Please see the gate wiring diagrams section to view the implementation options and information.







GATE STATUS SCREEN	
	 Gate is closed.
	 Gate is in the process of opening or closing
	 Gate is open.
	 Gate Status warning.
	IO 4 must be configured as the Gate Status input for this feature to be available.

TABLE 10.

### 3.8. SIM Screen





SIM SCREEN	
	 SIM PIN OK. This will display and then the screen will no longer be available.
	 The SIM PIN was incorrect. The SIM will remain locked and the <b>G-ULTRA</b> device will not receive or send events.
	 The SIM has encountered an error. This may require that the SIM be replaced or cleaned.
	IO 4 must be configured as the Gate Status input for this feature to be available.

TABLE 11.

### 3.9. IMEI Screen

As with all GSM devices, the IMEI number uniquely identifies the unit.



IMEI NUMBER	
	This displays the device's unit IMEI number. It will also display the custom name assigned to the device above the IMEI number.
	The name <b>G-ULTRA</b> , is editable using G-WEB.

TABLE 12.

## 4. WIRING DIAGRAMS

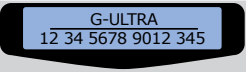

In the wiring options below, configuring the operation is a two-part process.

1. G-WEB is used to enable / configure the feature
2. Physical and correct wiring must be completed so that the feature functions as expected.

### 4.1. Gate Status Monitoring

These wiring instructions implement the physical requirements for the Gate Status Monitoring feature, which is configured in G-WEB.



Pre-requisite check: For this feature to function, G-WEB must be configured to enable gate status monitoring on IO4.



1. Before you begin, ensure that all devices have been powered down and the power (AC Mains and battery backup) has been disconnected.
2. Ensure that any new wiring does not change or compromise existing connections.

1. The IO connector strip is located under the main cover of the **G-ULTRA**. Carefully remove the cover to expose them
2. Using a small flat screwdriver, release the screws but without removing them to allow easy insertion for the wiring
3. Once you have prepared the ground wire:
  - a. On the **G-ULTRA**, common the GND and the VDC (minus) terminals
  - b. Now connect the **G-ULTRA** to the VDC(Minus) terminal to the COM of the D-Series controller
4. Connect IO4 to the STATUS output on the D-Series controller, if not already connected
5. Connect the +VDC terminal of the **G-ULTRA** to the Aux 12v out of the D-Series Controller
6. Once you have checked all connections, you may then power up the system

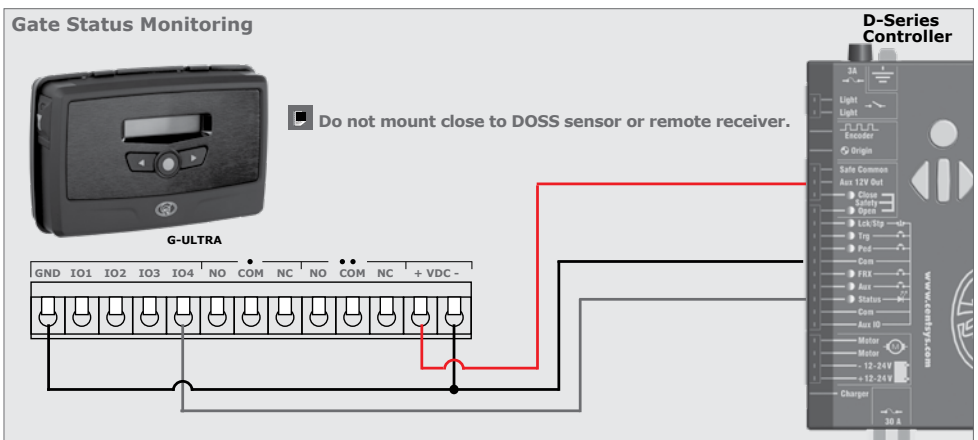

FIGURE 17.

## 4.2. Gate Trigger Pulse

These wiring instructions implement the physical requirements for the Trigger Pulse feature, which activates the gate.



Prerequisite check: For this feature to function, Relay X must be configured to close momentarily and then open, or pulse. Relay 1 or Relay 2 may be used; the instructions below detail the use of Relay 1.



1. Before you begin, ensure that all devices have been powered down and the power (AC Mains and battery backup) has been disconnected.
2. Ensure that any new wiring does not change or compromise existing connections.

1. The IO connector strip is located under the main cover of the **G-ULTRA**. Carefully remove the cover to expose them
2. Using a small flat screwdriver, release the screws but without removing them to allow easy insertion for the wiring
3. Once you have prepared the ground wire:
  - a. On the **G-ULTRA**, common the GND and the VDC (minus) terminals
  - b. Now connect the **G-ULTRA** to the VDC(minus) terminal to the COM of the D-Series controller
4. Connect IO4 to the STATUS output on the D-Series controller, if not already connected
5. Connect the +VDC terminal of the **G-ULTRA** to the Aux 12v out of the D-Series Controller
6. Once you have checked all connections, you may then power up the system

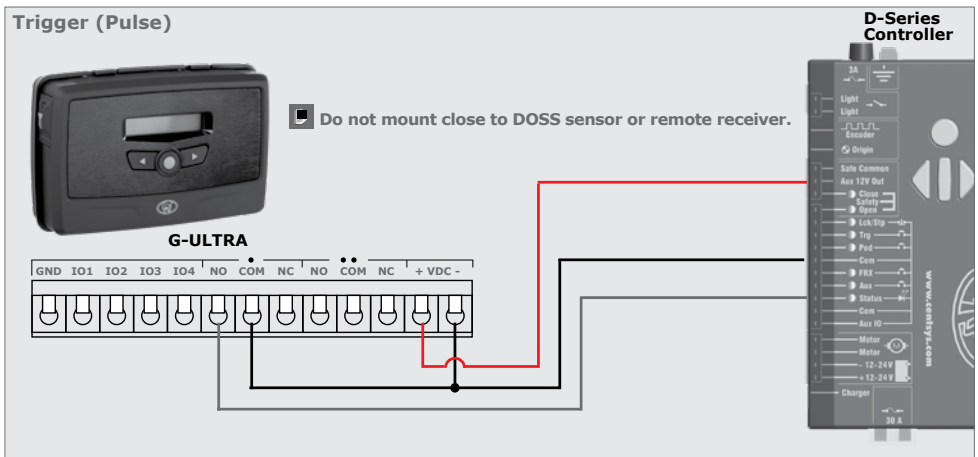

FIGURE 18.

### 4.3. Wiring the G-ULTRA into a D-Series Controller



1. Before you begin, ensure that all devices have been powered down and the power (AC Mains and battery backup) has been disconnected.
2. Ensure that any new wiring does not change or compromise existing connections.

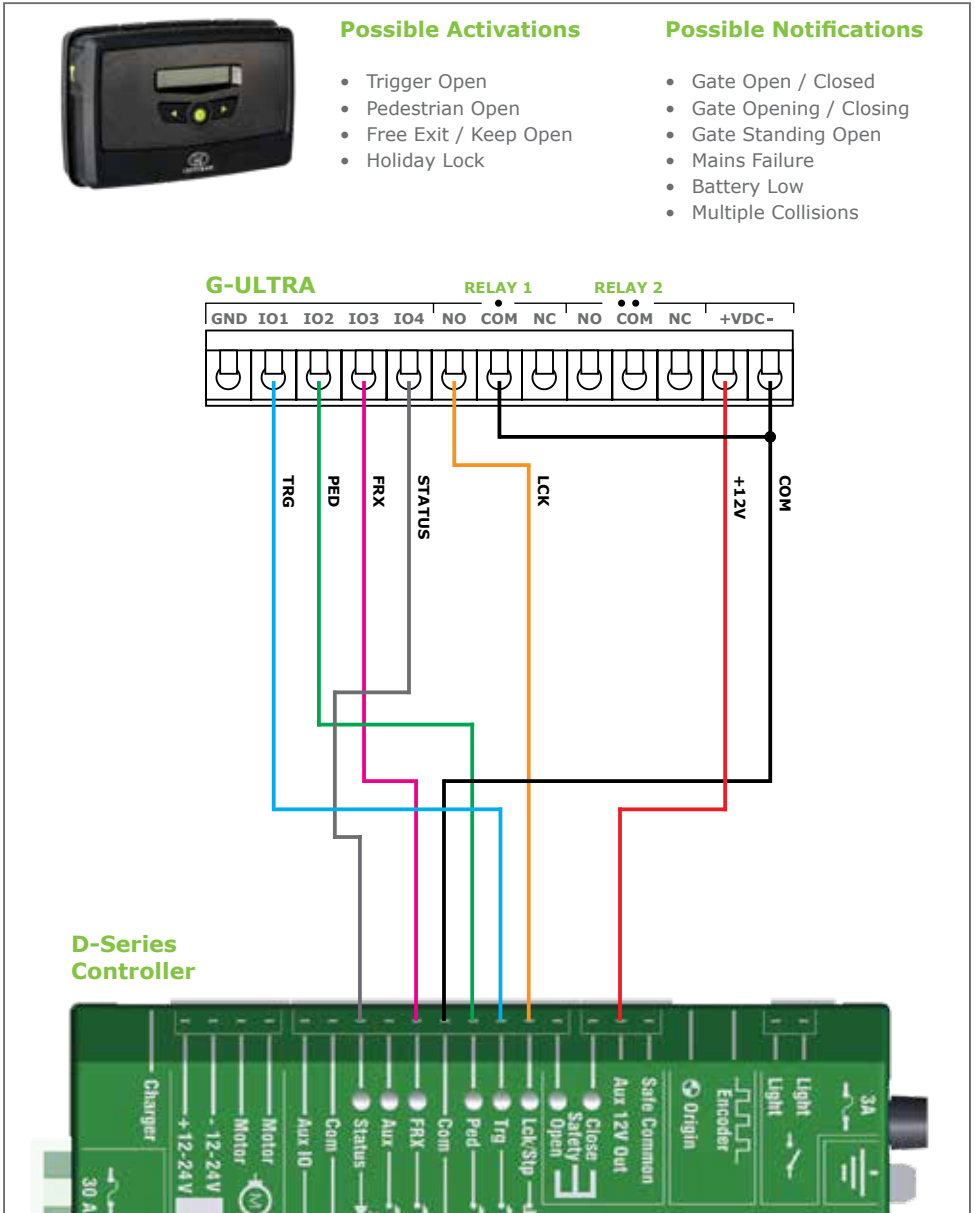

FIGURE 19.

### 4.4. Wiring the G-ULTRA into an Electric Fence



1. Before you begin, ensure that all devices have been powered down and the power (AC Mains and battery backup) has been disconnected.
2. Ensure that any new wiring does not change or compromise existing connections.



This wiring diagram can be used in conjunction with the G-WEB wizard

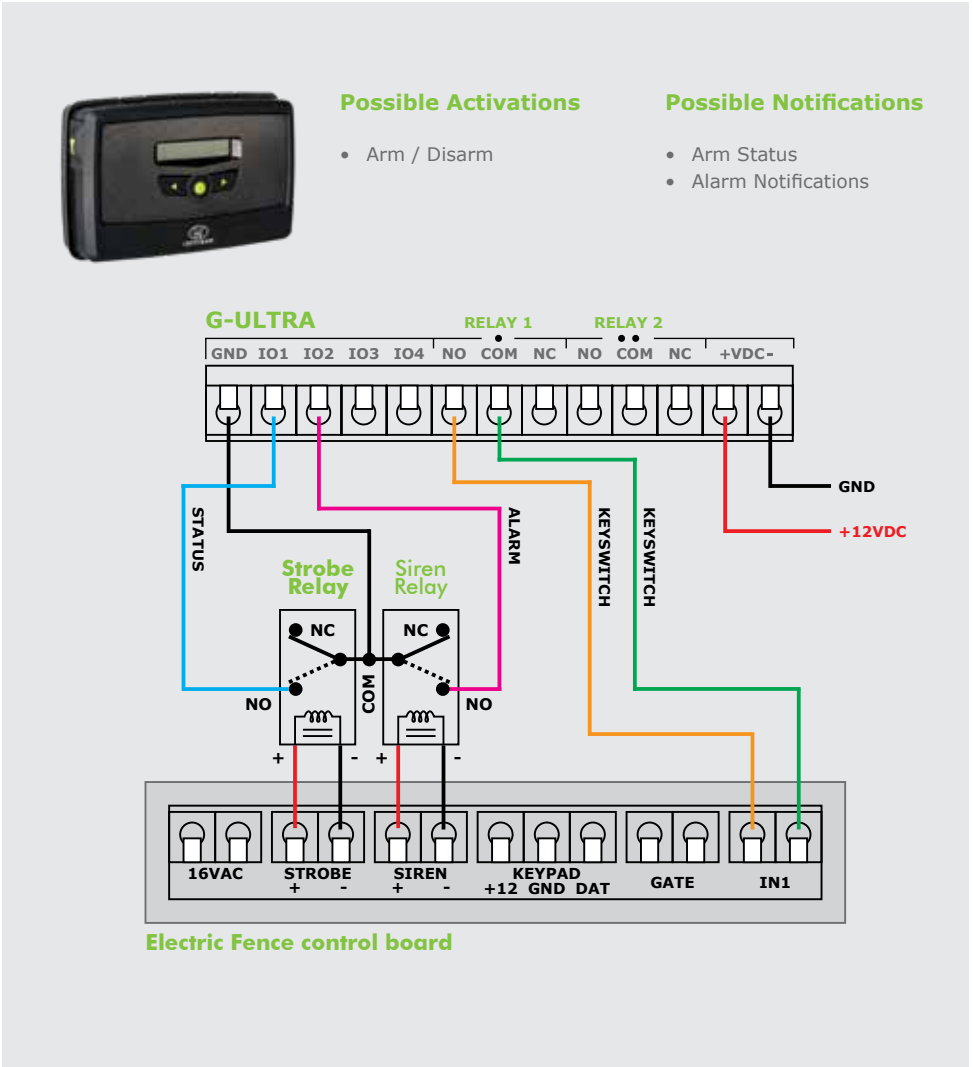

FIGURE 20.

### 4.5. Wiring a G-ULTRA into an Alarm System



1. Before you begin, ensure that all devices have been powered down and the power (AC Mains and battery backup) has been disconnected.
2. Ensure that any new wiring does not change or compromise existing connections.



This wiring diagram can be used in conjunction with the G-WEB wizard



#### Possible Activations

- Arm / Disarm

#### Possible Notifications

- Arm Status
- Intruder / Siren

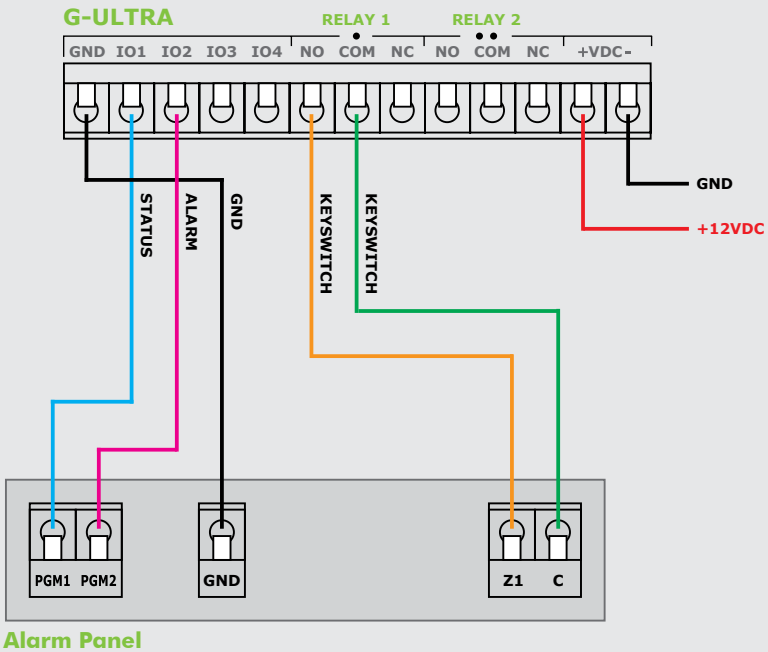

FIGURE 21.

## 4.6. Wiring a G-ULTRA into A D-Series Controller via a WiZo-Link



1. Before you begin, ensure that all devices have been powered down and the power (AC Mains and battery backup) has been disconnected.
2. Ensure that any new wiring does not change or compromise existing connections.



This wiring diagram can be used in conjunction with the G-WEB wizard

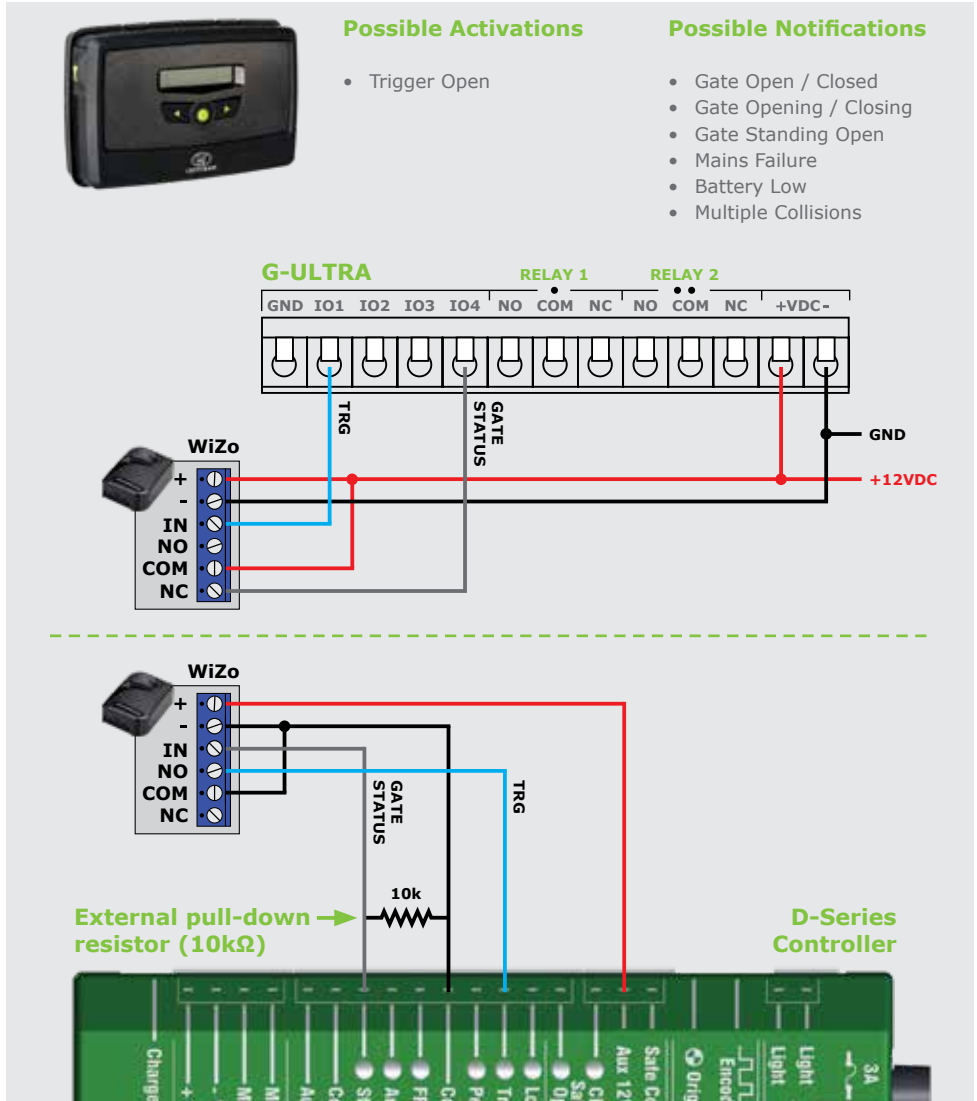

FIGURE 22.



### 4.7. Wiring a G-ULTRA into an Electric Fence Controller via WiZo-Links



1. Before you begin, ensure that all devices have been powered down and the power (AC Mains and battery backup) has been disconnected.
2. Ensure that any new wiring does not change or compromise existing connections.



This wiring diagram can be used in conjunction with the G-WEB wizard

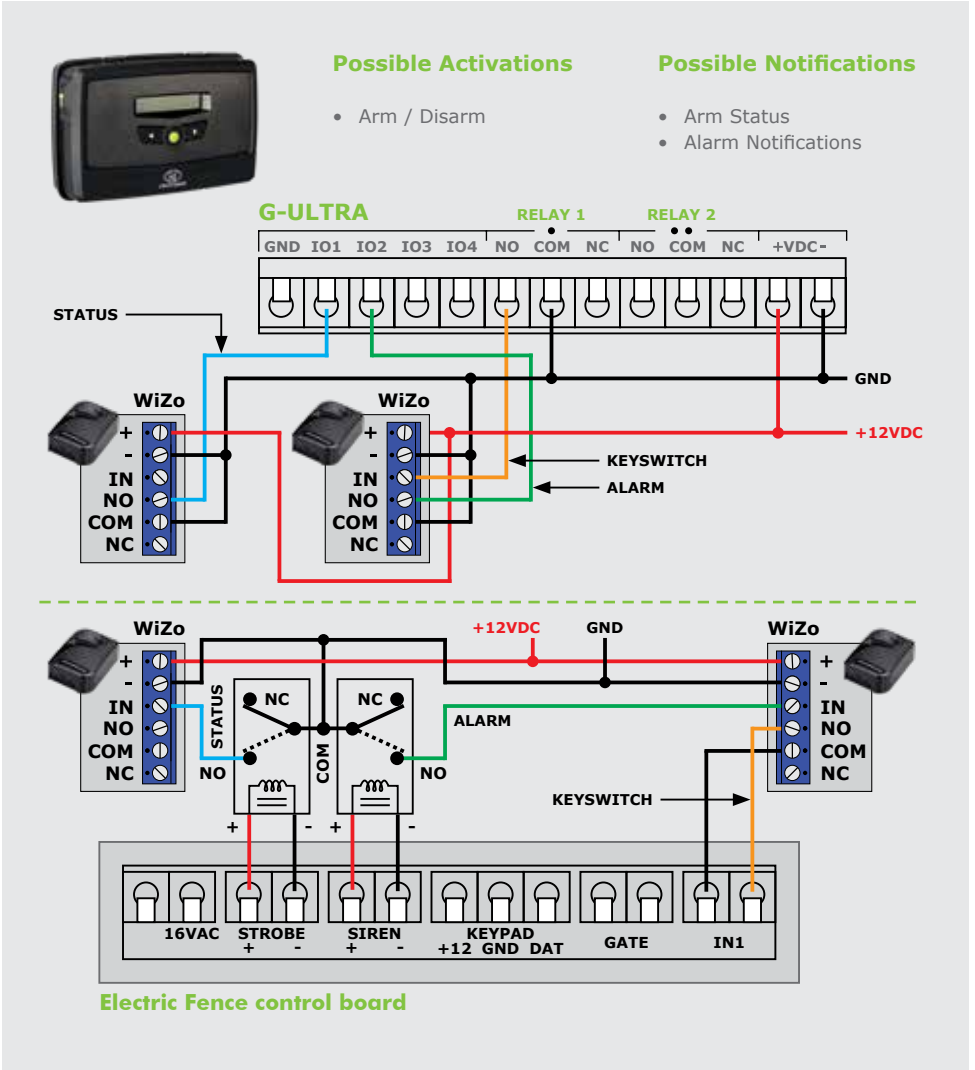

FIGURE 23.

### 4.8. Wiring a G-ULTRA into an Alarm System via WiZo-Links



1. Before you begin, ensure that all devices have been powered down and the power (AC Mains and battery backup) has been disconnected.
2. Ensure that any new wiring does not change or compromise existing connections.



This wiring diagram can be used in conjunction with the G-WEB wizard

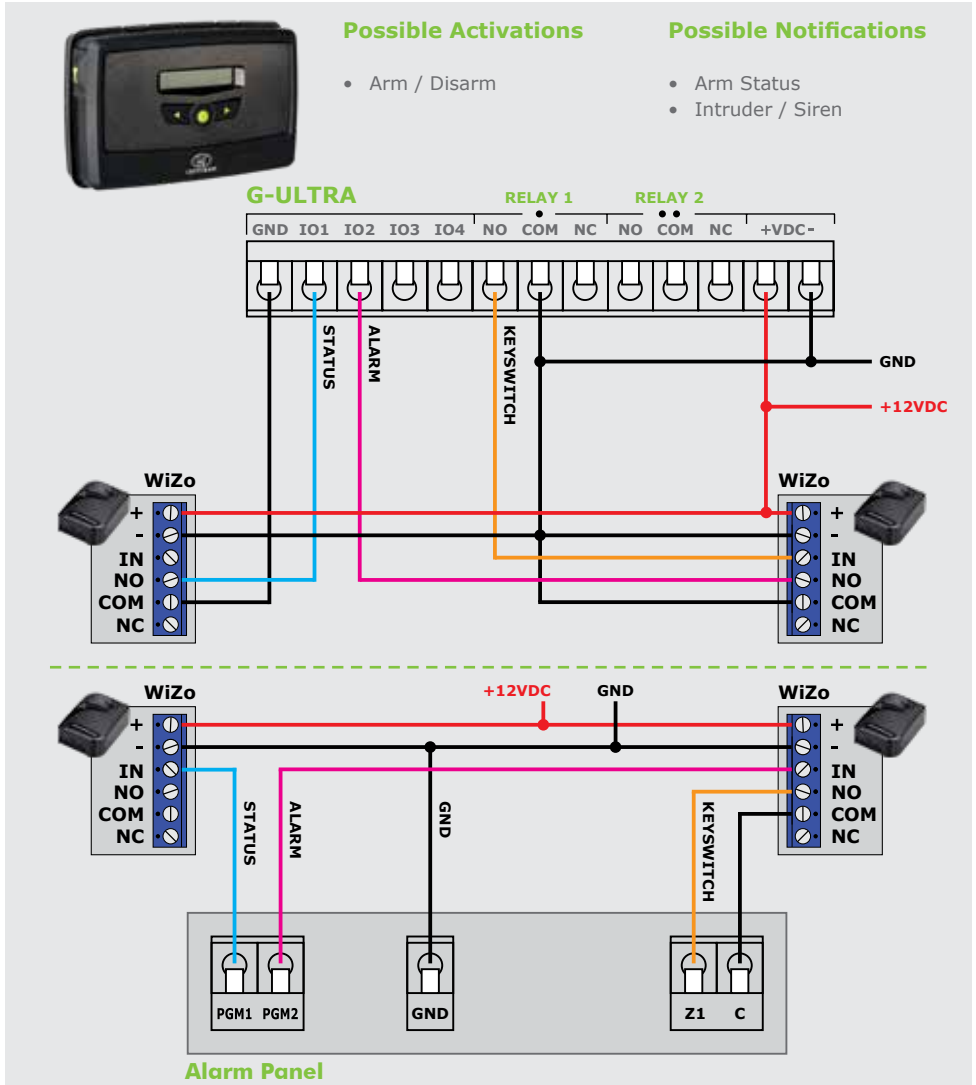

FIGURE 24.

## 5. G-WEB

### 5.1. Introduction to G-WEB

G-WEB comes in two iterations. The online version, which is a website, and provided you have an Internet connection and supported browser you can log in and configure the devices. The second option is the mobile app, which is compatible with either Android or IOS. G-WEB is used to configure or set up a **G-ULTRA** device or devices.

### 5.2. G-WEB Online

#### 5.2.1. Login / Create an Account

If you already have an account, browse to [www.gweb.co.za/login](http://www.gweb.co.za/login). Enter your username and password to log in and press Login.

If you do not, then click Register and follow the onscreen prompts to create the account. You will use this account to log in each time to perform changes, setup devices, top up your balance and so on.

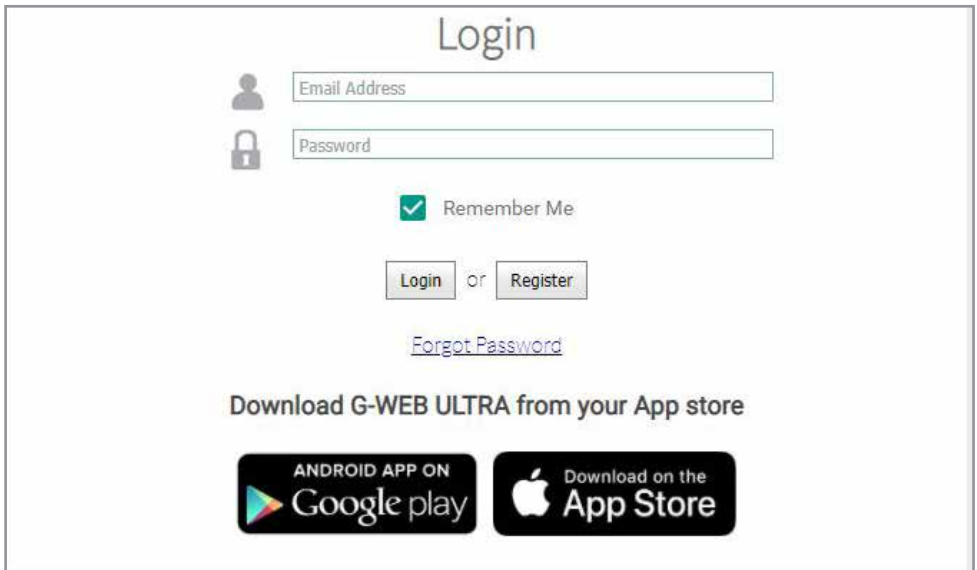

Login

Email Address

Password

Remember Me

Login or Register

[Forgot Password](#)

Download G-WEB ULTRA from your App store

ANDROID APP ON Google play

Download on the App Store

FIGURE 25.

### 5.2.2. G-WEB Dashboard

Once you have successfully logged in, the My Devices page functions as a landing page. This page lists all devices that have been associated with your profile and the devices you can administer. The top row of links enables access to the key functions which enable the user to administer devices, manage the user profile and contact's list.



FIGURE 26.

G-WEB	
My Devices	Lists all the devices that have been added, and are available on your profile.
My Profile	Maintains your personal profile.
My Contacts	Maintains your contact list.
Support	Email contact with support for assistance.
Help	Access to the current help, which includes documentation and videos.
Logout	Logout.

TABLE 13.

#### 5.2.2.1. Wallet

The Wallet displays the value in Rands that you have in credit on G-WEB; it does not indicate the SMS / Tokens available on each or one particular device. To recharge a device, see the section on Device Top Up.

Funds to top-up can be purchased via the G-WEB portal.

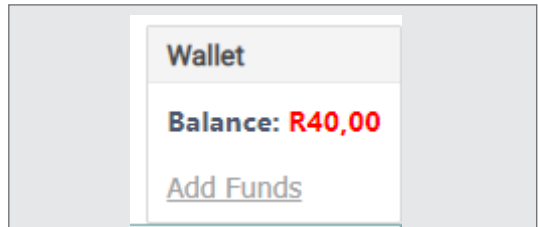

FIGURE 27.

#### 5.2.2.2. My Devices

The My Devices listing displays all G- type devices which have been added. Clicking on the link will return you to the default landing page. The My Devices page is capable of listing and maintaining the configuration data for many G-type devices.

Navigating to the settings of each device is done by clicking on the name, under the device name. You can filter according to devices by entering a search string and limit the returns by setting the page number size in the lower right-hand corner.



FIGURE 28.



G-SPEAK is beyond the scope of this manual.

### 5.2.2.2.1. Navigating the Device Listing

Access to the device, its settings, and configuration is done by clicking on the icon, as shown below. Some of the sections contain information only



FIGURE 29.

Feature	Description
Device Name	Custom name given to the device when it was added.
Mobile Number	The number of the SIM card loaded into the G-device.
Device Type	The type of G-device.
Last Synced	The date when a configuration sync was last done.
Airtime	The remaining CALLs and SMSs on the selected G-type device.
Device information	Details on the specific device.
Synchronise	Sync any changes from G-WEB to the selected device.
Device Top up	Top up the credit of tokens and SMS to the G-device.
Access Numbers	The list of numbers for mobile devices that have access to that specific device. Multiple numbers can be granted access to one device.
Settings	Time zone setting for the specific device.
Transfer Device	Transfers the device to a different profile and is done on request and is not automatic.
Secondary User	Add the details for additional users.

TABLE 14.

Access to the device, its settings, and configuration is done by clicking on the icon, as shown below. Some of the sections contain information only

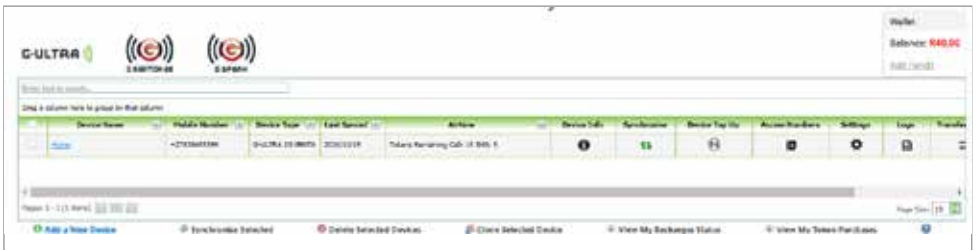

FIGURE 30.

Feature	Description
Add a new Device	Opens the dialogue to add a new device to the current profile.
Synchronise Selected	Transfers the settings for the selected device.
Delete Slected Device	Removes a device permanently from the device listing.
Clone Selected Device	Clones an existing device and transposes the configuration to a new, target device.
View My Recharge Status	Lists the details of device recharges.
View My Token Purchases	Lists the details of token purchases, and to which device they were credited.

TABLE 15.

### 5.2.2.2.2. Add Funds

To Add Funds, click the Add Funds link under the wallet value indicator

From the G-WEB portal page, do the following:

1. Click Add Funds

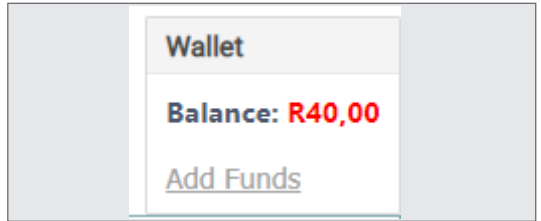

FIGURE 31.

2. Click on the drop down. Select your top up amount:
3. With an amount selected, click Proceed and you will be directed to process the transaction

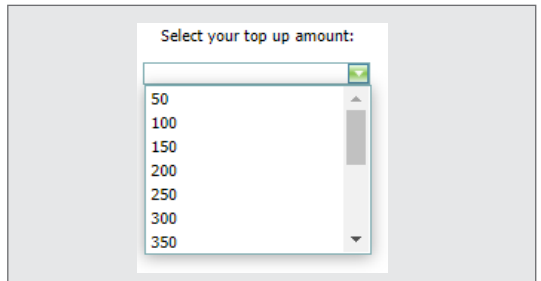

FIGURE 32.

### 5.2.2.2.3. Add New Device

To Add a new device, do the following:

1. From the My Devices page
2. Click Add New Device
3. Select the device to add, for example, **G-ULTRA**
4. Enter the following details, found on the side of the box
  - a. IMEI Number
  - b. Password which is a 4-digit password
  - c. A custom name for the device e.g. My Device
5. Click Add to complete the process



FIGURE 33.

#### 5.2.2.2.4. Synchronise / Synchronise Selected

Synchronising a device ensures that the configuration setup in G-WEB is transferred to the device and is kept up to date. The device sync is initiated by clicking the Synchronise icon, and at times owing to network issues it may not happen on the first attempt.

To synchronise a device, do the following:

1. Select a device or devices from the My Devices list
2. Click Synchronise Selected
3. You will be prompted to confirm the action

Alternatively, click the Synchronise icon ( ) in line with the device name.

#### 5.2.2.2.5. Delete Selected Devices

Deleting a device, deletes it from the current profile.

To delete a device, do the following:

1. Select a device or devices from the My Devices list
2. Click Delete Selected Devices
3. You will be prompted to confirm the action, click Yes to confirm
4. Click Yes, and the device is removed.

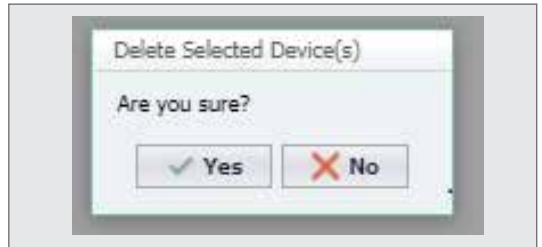

FIGURE 34.



The device has been deleted from your profile; however, it will still remain active

#### 5.2.2.2.6. Synchronise / Synchronise Selected



The cloning process clones the setting from one device to the next of the same type. If there is an existing configuration on the target device, it will be deleted

To Clone a device, do the following:

1. Select a device from the My Devices list
2. Click Clone Device
3. Select a device from the list to clone to, and click proceed

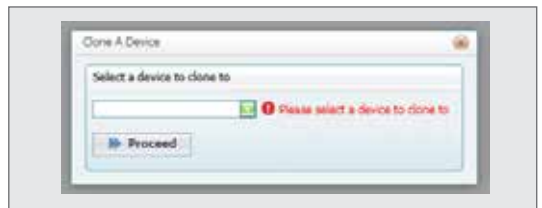

FIGURE 35.

### 5.2.2.2.7. My Recharges

The recharge log retains a list of all recharge events.



FIGURE 36.

### 5.2.2.2.8. Device Token Top-up



To recharge a device, a G-WEB account credit is required.

To Top Up Device Tokens, do the following:

1. From the My Devices page, select a device
2. Locate the Top Up Icon, and click it
3. From the Device Token Top Up, select the type of token to Top Up i.e. Calls or SMS
4. Use the - / + buttons to decrement / increment the tokens value
5. Click Top up Tokens
6. The tokens will be Topped Up

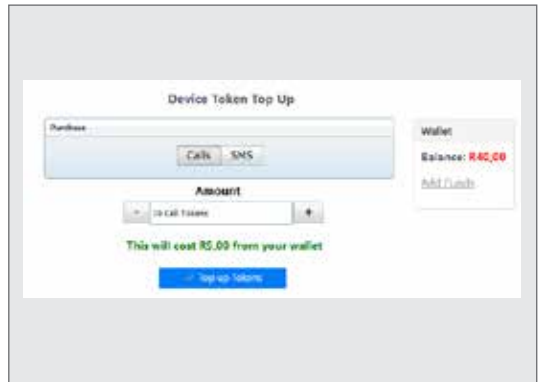

FIGURE 37.

### 5.2.2.3. My Profile

To view your profile information, click on the My Profile link.

#### 5.2.2.3.1. Personal Details

To update Personal Details, do the following:

1. From the Landing Page, click My Profile
2. Populate the details as shown below
3. Click Done, at the bottom of the page



FIGURE 38.



### 5.2.2.3.2. Change Password

Changing the password is changing the password that was supplied at the time of manufacture.

To change the profile password, do the following:

1. Click on My Profile
2. Under Personal Details, click Change Password
3. Enter the current password, and click OK

FIGURE 39.

4. Enter a new password, following the instructions provided. Click Ok

FIGURE 40.

### 5.2.2.3.3. Security Settings

Select the security that will be applied to your profile; this will determine to what extent CENTURION Support is to assist

To change the settings:

1. Click My Profile
2. Select one of the options
3. When done, select Done at the bottom of the page

FIGURE 41.

### 5.2.2.3.4. Notification Settings

In the Notification Settings, the method of communication is selected along with the credit options for your wallet

To change the settings:

1. Click My Profile
2. Under Notification Settings, select a preferred contact method
3. When done, select Done at the bottom of the page

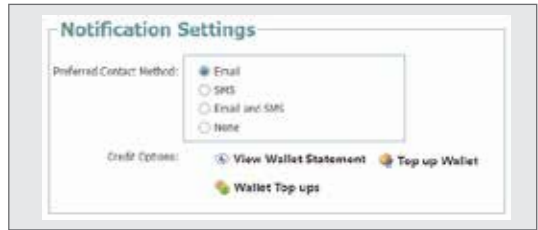

FIGURE 42.

### View Wallet Statement

The Wallet Statement provides a transaction history for airtime purchases for your account, which are credited to each device associated with your profile

To view the Wallet Statement, do the following:

1. Click My Profile
2. Under Notification Settings, select View Wallet Statement
3. When done, select Done at the bottom of the page

Date of Transaction	Number	Description	Opening Balance	Debited	Credited	Closing Balance
2020/10/13 23:32	27838455599	MTN Credit Top UP	R45,00	R5,00	R0,00	R40,00
2020/10/13 23:32	27838455599	MTN Credit Top UP	R50,00	R5,00	R0,00	R45,00
2020/10/07 15:02		Credits Purchased	R0,00	R0,00	R50,00	R50,00

Page 1 of 1 (3 items) Page size: 10

FIGURE 43.

4. To export the statement, click Export
5. Select the export format, with the option to only export the selected items
6. The report is generated and opens once complete

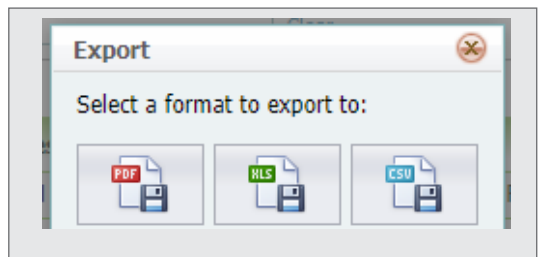

FIGURE 44.

## Company Details

If you are a company, then the company details are captured in the section shown below

To view and change company details, do the following:

1. Click My Profile
2. View the details that have been captured, and update where needed
3. When the changes are made, click Done at the end of the page

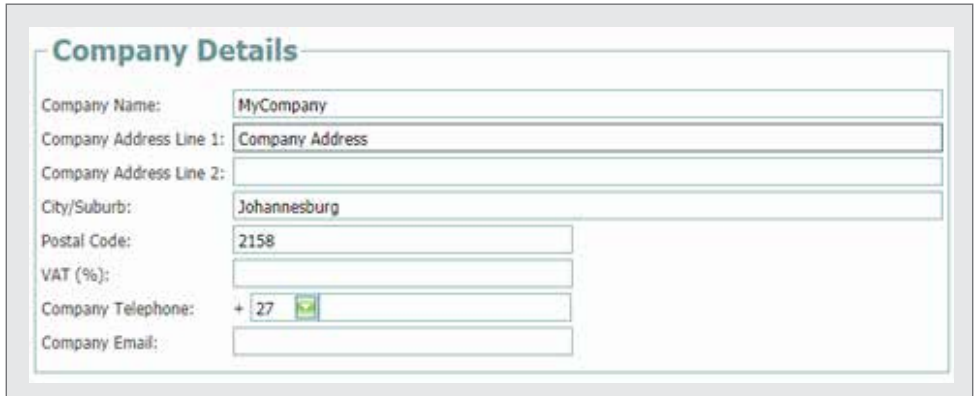

**Company Details**

Company Name: MyCompany

Company Address Line 1: Company Address

Company Address Line 2:

City/Suburb: Johannesburg

Postal Code: 2158

VAT (%):

Company Telephone: + 27

Company Email:

FIGURE 45.

## Time Zone

The time zone can be configured, and is set to UTC+0200 for South Africa

1. Click My Profile
2. Locate the Time Zone setting, and click on the drop down

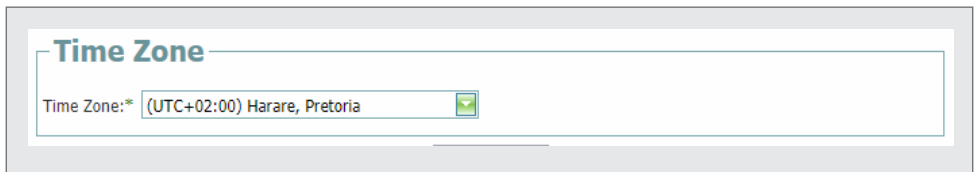

**Time Zone**

Time Zone:\* (UTC+02:00) Harare, Pretoria

FIGURE 46.

3. Change the setting to the appropriate time zone
4. When the changes are complete, click Done

### 5.2.2.4. My Contacts

Create a contacts list under My Contacts. This list retains the numbers of devices which can be associated with one or more profiles.



Access numbers can be imported from the contacts list

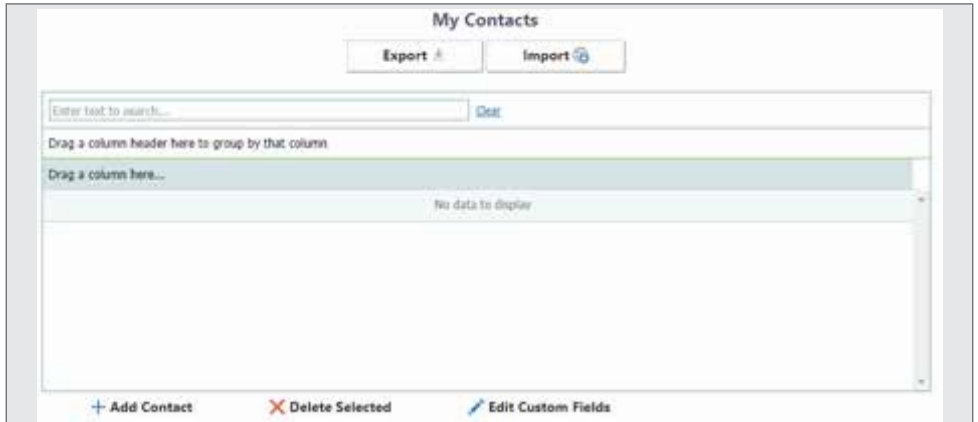

FIGURE 47.

#### 5.2.2.4.1. Add Contact

Create a contacts list to associate as secondary numbers.

To add a contact, do the following:

1. Click My Contacts
2. Click Add Contact
3. Enter a Name and Contact Number
4. To add multiple numbers, Click Done Next, or
5. Click Add for a single contact
6. Click Cancel to end

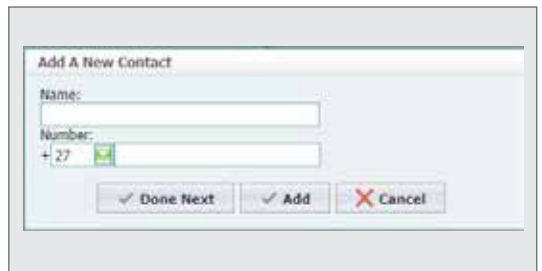

FIGURE 48.

#### 5.2.2.4.2. Delete Selected

Once a list of contacts has been created you can delete any old, unwanted numbers.

To delete numbers from the contact list, do the following:

1. Click and highlight at least one number
2. Click Delete Selected

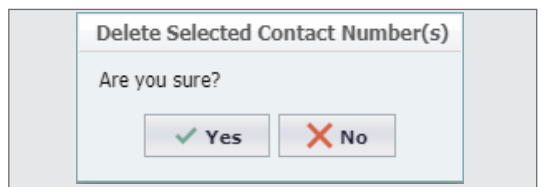

FIGURE 49.

### 5.2.2.4.3. Edit Custom Fields

Custom Fields allow you to store customised information along with the contact number.

To edit Custom Fields, do the following:

1. Click My Contacts
2. Click Edit Custom Fields
3. Enter a name for the Field
4. Click Save
5. The field will now appear in the My Contacts list

FIGURE 50.

### 5.2.2.4.4. Managing the Contact List

#### Edit an existing number

To edit an existing number, do the following:

1. Click My Contacts
2. From the list of numbers displayed, locate the Edit icon and click it
3. Enter the new number
4. Click Save when done

FIGURE 51.



Custom fields will be displayed for editing

#### Delete a single number

To delete a number, do the following:

1. Click My Contacts
2. From the list of numbers displayed, locate the Delete icon and click it
3. Click Yes to confirm and No to cancel

FIGURE 52.

### 5.2.2.4.5. Export Contacts

To export the contact list, do the following:

1. Click My Contacts
2. Click Export, and the list will be downloaded onto the local machine in Excel format

### 5.2.2.4.6. Import Contacts

To import a list of contact numbers, do the following:

1. Click My Contacts
2. Click Import
3. Follow the steps in the Wizard below:

The screenshot shows a three-step wizard for importing contact numbers. Step 1 instructs the user to use a template and provides a 'Download Template' button. Step 2 asks the user to browse for a file to upload, with a 'Browse...' button. Step 3 prompts the user to update contact numbers, with an 'Update Contact(s)' button.

FIGURE 53.

### 5.2.2.5. Support

When product support is required for a particular issue, do the following:

1. Click on Support
2. Populate the Feedback form below, and click Send when done

The screenshot displays a feedback form titled 'G-web Feedback Form'. It contains input fields for 'Name', 'Email Address', and 'Message'. Below these is a 'NUMBER VERIFICATION' section featuring a CAPTCHA image with the number '13254', a 'show another code' link, and a text input field for the user to type the code. A 'Send' button is located at the bottom left of the form.

FIGURE 54.

### 5.2.2.6. Logout

To logout, click Logout.

### 5.2.3. Managing and Configuring Individual Devices

Once you have added a device, you will then be able to configure and manage the newly- added device. To access the device, click on the link which is also the device name. An example is shown right.

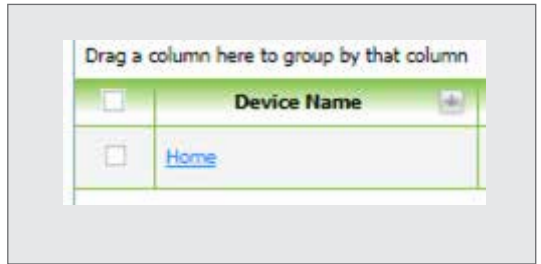

FIGURE 55.

Clicking on the device opens up the menu system as shown

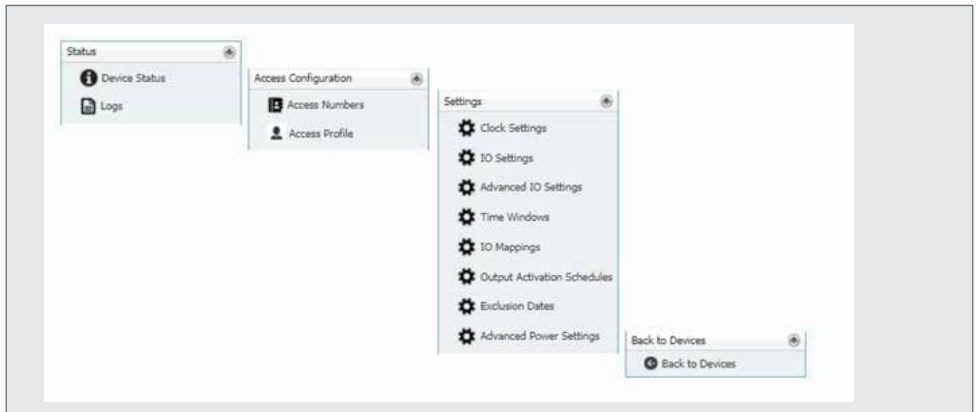

FIGURE 56.

#### 5.2.3.1. Status

##### 5.2.3.1.1. Device Status

The Device Status details 1) Connection Information, 2) General Information related to the selected device, 3) Device tokens remaining

#### Connection Information

The information relates to:

1. When the device was last connected
2. The last sync, which may have updated the devices' configuration
3. The status of the connection i.e., connected or disconnected.

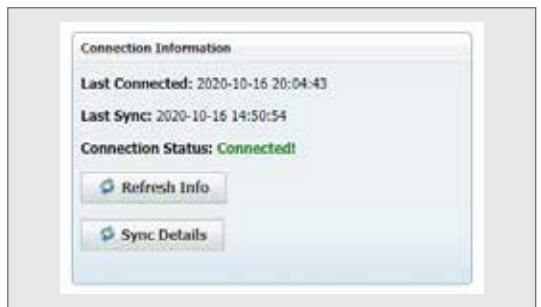

FIGURE 57.

## Refresh Info

To refresh the information, do the following

1. Click Device Status
2. Click Refresh Info
3. Wait for a response from the device, which will depend on network conditions

## Sync Details

The Sync Details Information is a report which details whether the selected device has any new changes pending which have not yet synced or been downloaded to the device.

To view the Sync Information, do the following:

1. Click Device Status
2. Click Sync Details
3. The following report will display
4. Click Refresh to update the List
5. Click Reboot device if needed



Rebooting the device will mean that it is unavailable while the reboot takes place

Sync Information

Connection Status: **Connected!**

Sync Status: **Device is Synchronised**

[Refresh](#) [Reboot Device](#)

Last Connected: 2020-10-16 20:11:38

Last Sync: 2020-10-16 14:50:54

Category	Quantity	Status
Access Numbers	0	All Synced
Profile Settings	0	All Synced
Time Visitor Windows	0	All Synced
Time Windows	0	All Synced
Messages	0	All Synced
Day Light Savings	0	All Synced
Device Config	0	All Synced
3D Config	0	All Synced
Scheduled Outputs	0	All Synced
Logs	0	All Synced

FIGURE 58.

## General Information

The General Information Report details the base information relating to the selected device

To view the General Information, do the following:

1. Click the Device Status link
2. The General Information box will be displayed below the Sync Information



Keep the Subscribe to Automatic Updates enabled to receive new update to the selected device when available

3. Click the refresh link to update the information

General Information [Refresh](#)

Device Name: Home [Edit](#)

Password: 3033 [Change Password](#)

Device Type: G-ULTRA 3G PENTA

IMEI: 86830040106923

Phone Number: +27926455599

Supply Voltage: 12.28 V

Signal Strength: 3/5

Network: MTN

Details: Data Connection: 3G  
Profiles: 2  
Access Numbers: 2  
Scheduled Outputs: 1  
3D Mappings: 0

Firmware Version: 2.4.8

Firmware Updates: Firmware is up to date

Subscribe to Automatic Updates

FIGURE 59.



## Device Tokens Remaining

The tokens enable the device to send messages and to make calls.

To view the Device Tokens Remaining, do the following:

1. Click the Device Status link
2. The Device Tokens Remaining will display below
3. You may also do the following
  - a. To refresh the information, click the Refresh link
  - b. To purchase additional tokens, click Purchase
  - c. To set thresholds, click Set Low Threshold

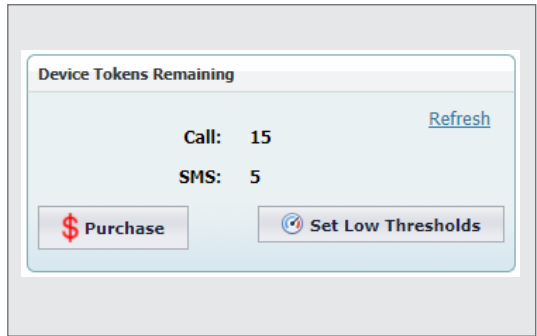

FIGURE 60.

### 5.2.3.1.2. Logs

The logs contain device activity information, for example, event notifications.

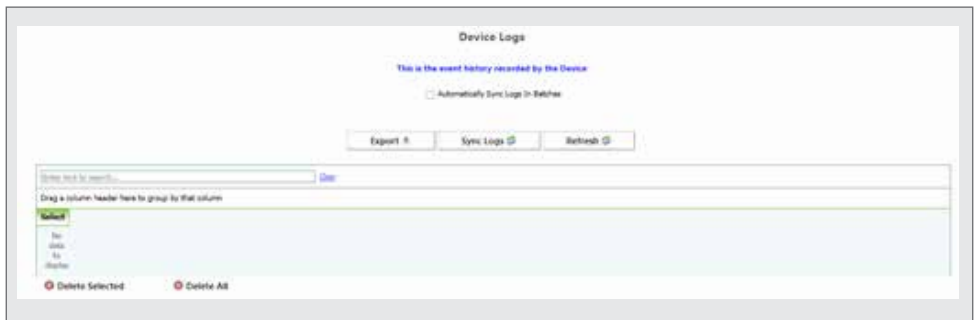

FIGURE 61.

Feature	Description
Export	Exports the logs into useable formats onto the local machine.
Sync Logs	Sync / uploads log data from the selected device.
Refresh	Refreshes the log listing.

TABLE 16.

## Export Log Data

Exports the log data to the local machine in a PC- friendly format

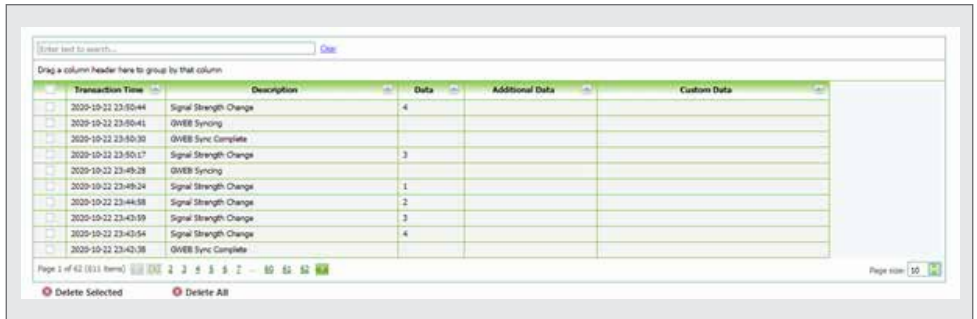

Transaction Time	Description	Data	Additional Data	Custom Data
2020-10-22 23:50:44	Signal Strength Change	4		
2020-10-22 23:50:41	OWEB Syncing			
2020-10-22 23:50:30	OWEB Sync Complete			
2020-10-22 23:50:17	Signal Strength Change	3		
2020-10-22 23:49:28	OWEB Syncing			
2020-10-22 23:49:24	Signal Strength Change	1		
2020-10-22 23:44:58	Signal Strength Change	2		
2020-10-22 23:43:59	Signal Strength Change	3		
2020-10-22 23:43:54	Signal Strength Change	4		
2020-10-22 23:42:38	OWEB Sync Complete			

FIGURE 62.

To export the log, do the following:

1. Select a device from the device listing
2. Select Logs
3. Click Export
4. Choose to Only Export Selected; the default is to export all the logs available
5. Select a format for the exported file
6. Click on the file format required, and the log will be downloaded onto the local machine in the Downloads folder

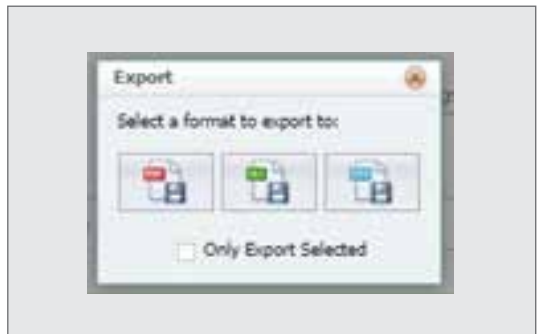

FIGURE 63.

## Sync Logs, Refresh

Syncing the logs from the device uploads the latest device activity data to G-WEB.

To export the log, do the following:

1. Select a device from the device listing
2. Select Sync Logs
3. The following will appear
4. Click Ok, and wait for the logs to be synced from the device
5. Click Refresh once the logs have been synced.

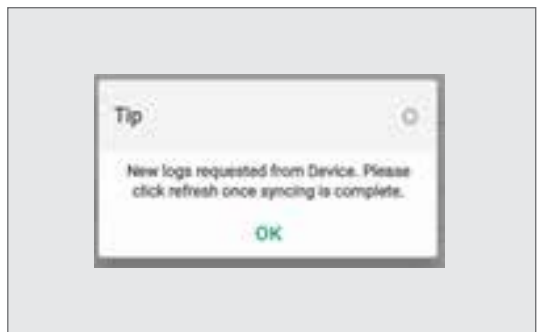

FIGURE 64.

## Delete, Delete All

The log data can be deleted as over time it no longer has diagnostic value.

To delete the log, do the following:

1. Select a device from the device listing
2. Select a log or more than one
3. Click Delete Selected, and select Yes to continue
4. The log is deleted

Alternatively, click Delete All, and all logs will be permanently deleted.

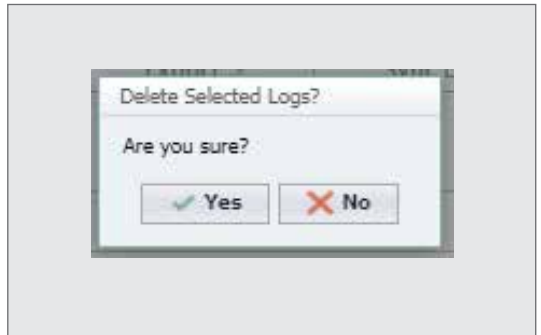

FIGURE 65.

### 5.2.3.2. Access Configuration

Configure the access to the devices and the mobile device numbers that will be associated with a profile.

#### 5.2.3.2.1. Access Numbers

Contains a list of numbers for which access is granted to a device. You can import a list of numbers and later export your contact list.

### Import Numbers

Importing a list of numbers will automatically populate the Device Access numbers.

To import a list of numbers, do the following

1. Click on the device
2. Select Access Numbers
3. Click Import
4. Click on Download Template, and populate the template
5. Once the template is populated, upload the file by clicking Browse
6. Locate the file and upload

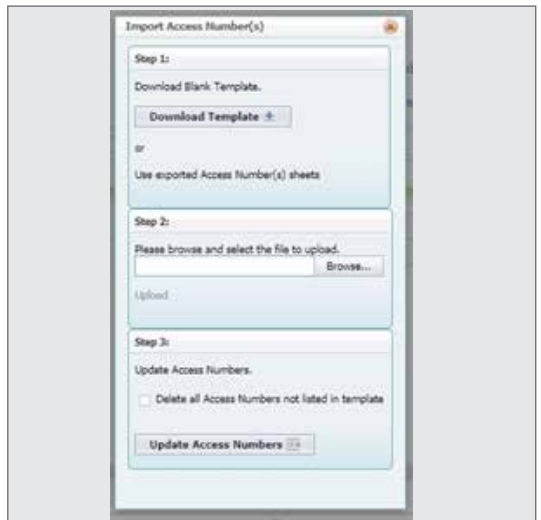

FIGURE 66.

## Updating the Access Numbers with the Template

You can update the numbers in the system, by 1) adding numbers to the template and uploading the template and/or 2) deleting numbers from the template and then uploading the template again. The system will then automatically retain only the numbers listed in the template.

To update the access numbers, do the following:

1. Click on the Device
2. Select Access Numbers
3. Click Import
4. Browse for the file
5. Enable the option to Delete All Access Numbers not listed in the template
6. Click Update Access Numbers

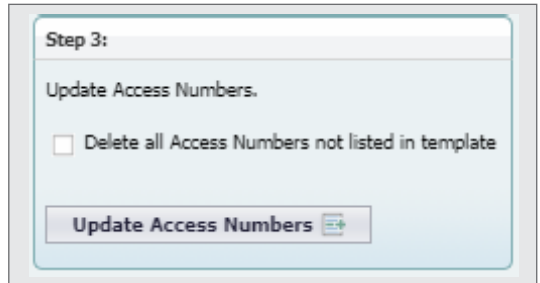

FIGURE 67.

## Export Numbers

Exports the list of numbers to a PC-friendly format. This would also enable you to import the numbers list into other profiles.

To export the list of numbers, do the following:

1. Click Export
2. Select the required format, i.e. PDF, Excel or CSV
3. The file will be downloaded

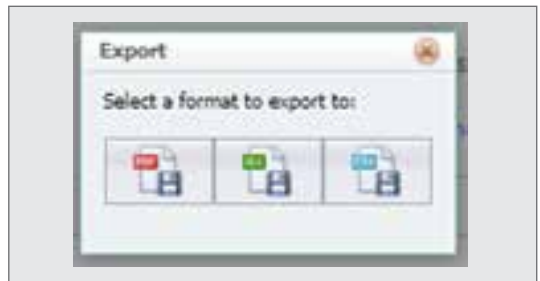

FIGURE 68.

## Add Access Number

Numbers can be added manually, one at a time.

To update the access numbers, do the following:

1. Select the device
2. Select Access Numbers
3. Click Add An Access Number
4. Populate the Fields as shown below
5. Configuring Visitor Access Control
  - a. Configure Visitor Access. To do so, select Enable and configure the dates and times the number will have access
    - i. Select a Date From
    - ii. Select a Time From
    - iii. Select a Date To
    - iv. Select a Time To
    - v. You can retain / delete the number once the Visitor Access Control has expired; this is the default so disable if not needed.
6. Click Done

FIGURE 69.

## Add Access Number From Contact List

Numbers can be added from the global contact list to be associated with the selected device.

To add an access number, do the following:

1. Select a device
2. Select Access Numbers
3. Click Add Access Number from Contact List
4. Select a number, and click Add Contacts
  - a. If the number is not listed, click Edit Contacts, to Add the number
5. Select a profile
6. Click Add Contacts

FIGURE 70.

## Delete Selected Numbers

Delete one or more numbers manually if a bulk delete is not required. For bulk deletes / updates see the Updating Template section

To delete a number for a device, do the following:

1. Select the device
2. Select Access Numbers
3. Select a number
4. Click Delete Selected Numbers
5. Click Yes, and the number will be deleted

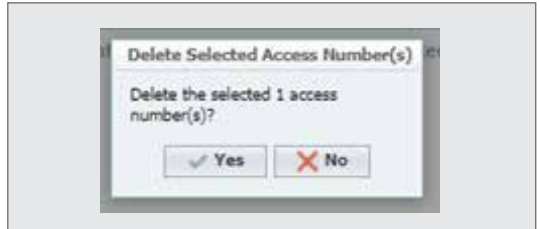

FIGURE 71.

## Edit Selected Numbers

Edit an existing number manually once it is on the system.

To edit an existing number:

1. Select the device
2. Select Access Numbers
3. From the list of numbers, select at least one number and click Edit Selected Number(S)
4. The following can be changed
  - a. You can suspend the number by enabling Suspend
  - b. Send / Resend the welcome SMS
  - c. Select the profile with which the number is associated
  - d. Configure Visitor Access. To do so select Enable and configure the dates and times the number will have access
    - i. Select a Date From
    - ii. Select a Time From
    - iii. Select a Date To
    - iv. Select a Time To
    - v. You can retain / delete the number once the Visitor Access Control has expired, this is the default so disable if not needed.
5. Click Done



FIGURE 72.

## Device Welcome Message

The Device Welcome Message is sent when a number is added to the access numbers list, giving the mobile number access to the selected device

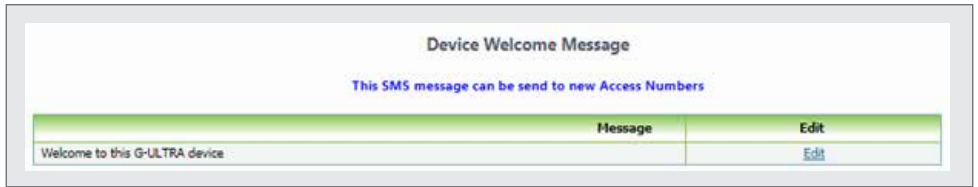

FIGURE 73.

### Edit the Welcome Message

Customise the welcome message that is sent.

To edit the welcome message, do the following

1. Select the device, by clicking on the name
2. Click Access Numbers
3. Scroll down to the bottom of the screen
4. Click Edit
5. Edit the text field with the new message, and click Update to save the changes

### 5.2.3.2.2. Access Profile

The Access Profile is a set of security features that determines when numbers of a sub-profile can have access to a **G-ULTRA** device and system notifications

At least one profile, the Admin profile is required. You can create as many profiles as needed to configure the security as needed.



FIGURE 74.

### 5.2.3.2.3. How to Add a Profile

This adds a new profile, which can be an Admin profile.

To add a profile, do the following:

1. Select the device
2. Select Access Configuration
3. Select Access Profile
4. Click Add Profile
5. Add the profile name, and set as Admin. The default is non-Admin
6. Click Save and a blank profile has been added which must be configured

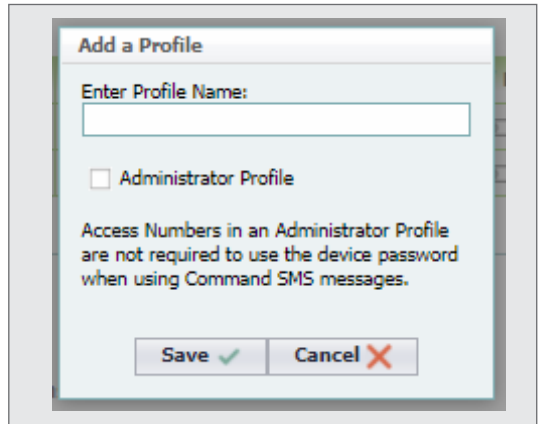

FIGURE 75.

### 5.2.3.2.4. How to Edit a profile

Editing the Profile changes the name of the profile.

To edit a profile, do the following:

1. Select a device
2. Select Access Profile
3. Locate the Edit icon inline with the profile to edit
4. Edit the name of the profile, and if this is not the Admin profile uncheck the Administrator Profile check box
5. Click Save to complete



FIGURE 76.

### 5.2.3.2.5. Activations

The activations are device-specific actions for incoming calls and SMS messages. These need to be set per device, but once configured they can be pushed to a user profile which then sets the same activations for a group of numbers associated with that profile



## G-REMOTE

This feature enables you to limit access to IO for a specific device, using the Access Profile feature. For example, a **G-ULTRA** may have two IO configured for entrance purposes. If those areas are restricted, you can create an Access Profile which remotes the button on G-REMOTE which would allow the user to open the door, gate, etc.

### Configure Visible IO



To configure this feature, you may require a Time Window and Access Profiles configured.

The IO becomes visible when it is represented to a G-REMOTE user as either a Button or an Input Notification. Buttons may activate gates and/ or equipment and Input Notifications may not apply to a user who only needs to be able to open the gate, and does not need to know if an electric fence generated an alarm.

### Configure Visible IO - To hide the IO

To hide the IO, do the following:

1. Select the device
2. Select Access Profile
3. Click on the Activations icon adjacent to the Profile Name
4. Click on the Visible / Hidden toggle
5. Click Push Permissions to Profile Users



FIGURE 77.

### Configure Visible IO – Edit

To edit the IO, do the following:

1. Select the device
2. Select Access Profile
3. Click on the Activations icon adjacent to the Profile Name
4. Click on Edit
5. Select a Time Window
  - a. Anytime: The default which gives perpetual access
  - b. [Custom Time] : Select a custom time from the drop down. If none are visible, you will need to create one
6. Click Update to Save the settings or Cancel
7. Click Push Permissions to Profile Users to complete the update



FIGURE 78.

## Calls (DTMF / Missed Call)

The Calls feature enables the device to be configured for missed call functionality, i.e. reject the incoming call or answered to enable DTMF button Activations



Configuration depends on available outputs. Ensure that outputs have been configured

### Configure Incoming Call Action: DTMF

To configure the Incoming Call Action: DTMF, do the following:

1. Select the device name
2. Select Access Profile
3. Click on the Activations icon adjacent to the Profile Name

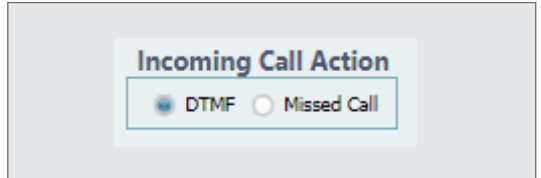

FIGURE 79.

4. Click on Calls
5. Select DTMF, select Enable, and click Edit to configure a button
6. Select one or more of the available Outputs available, and configure the type of action
7. Select a Time Window, by clicking on the Time Window dropdown. The default is "Anytime"
8. Click Update

### Configure Incoming Call Action: Missed Call

To configure the Incoming Call Action: Missed Call, do the following

1. Select the Device Name
2. Select Access Profile
3. Click on the Activations icon adjacent to the Profile Name
4. Click on Calls

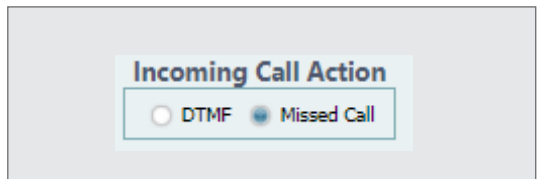

FIGURE 80.

5. Select Missed Call, select Enable, and click Edit to configure a button
6. Select one or more of the Outputs available, and configure the type of action
7. Select a Time Window, by clicking on the Time Window drop-down. The default is "Anytime"
8. Click Update

### 5.2.3.2.6. Notifications

Notifications are customisable messages that are sent from the device to the profile when an event takes place. The notifications can be configured by profile and can also be configured for profile-to-profile notifications.

#### 5.2.3.2.7. Notification Settings

##### Global Device Outgoing Notification Messages

To create the Custom Message, do the following

1. Click on the Device Name
2. Click Access Profiles
3. Click on Notifications, and click Edit from the Global Device Outgoing Notification Messages
4. Enter the text for the message
5. Click Update to save the message and repeat the process to create as many custom messages as needed to a maximum of 18

##### Input Trigger Outgoing Notification

To create the Input(s) Trigger Outgoing Notification, do the following

1. Click on the Device Name
2. Click Access Profiles
3. Click on Notifications, and select an input from the Input(s) Trigger Outgoing Notification



The name of the input will change depending on what the input was named when configured

4. For Edge Rising / Edge Falling:
  - a. Enable the input
  - b. Click Edit
  - c. Select a Message from the dropdown, which was created above and select the delivery medium
  - d. Select the Time Window
  - e. Enable / Disable the missed call trigger
  - f. Enable / Disable G-REMOTE access
5. Click Update to save the changes

## Output Trigger Outgoing Notification

To create the Output(s) Trigger Outgoing Notification, do the following

1. Click on the Device Name
2. Click Access Profiles
3. Click on Notifications, and select an input from the Output(s) Trigger Outgoing Notification



The name of the input will change depending on what the input was named when configured

4. For State On / State Off:
  - a. Enable the Output
  - b. Click Edit
  - c. Select a Message from the Drop Down, which was created above, and select the delivery medium
  - d. Select the Time window
  - e. Enable / Disable the missed call trigger
  - f. Enable / Disable G-REMOTE access
5. Click Update to save the changes

## Device Offline Notifications

If the device goes offline, a notification will be received via G-REMOTE by all users in the access profile.

To configure the Device Offline notifications, do the following:

1. Select the Device Name
2. Select Access Profiles
3. Select Notifications
4. Under Device Offline Notifications, enable the notification and then click Edit

G-REMOTE	Email	Edit	Enable / Disable
<input type="checkbox"/>	<input type="checkbox"/>		

G-REMOTE:  Email:

[Update](#) [Cancel](#)

**FIGURE 81.**

5. Enable / Disable G-REMOTE, and optionally enable email.
6. Click Update to save the changes

## System Outgoing Notifications

These notifications notify the profile users of system events that may interrupt or hamper its operation, for example SMS Token Balance Low

To Configure the System Outgoing Notification, do the following:

1. Select the Device Name
2. Select Access Profiles
3. Select Notifications
4. Under System Outgoing Notification, identify one from the list, enable it and Click Edit
5. Select the delivery medium, G-REMOTE access, and the Time Window
6. Click Update to save the changes

### 5.2.3.2.8. Enable / Disable Access Profiles

Access Profiles can be disabled or deactivated, and the profile retained if needed.

To Enable / Disable the Access Profile do the following:

1. Select the Device Name,
2. Select Access Profile
3. Click on the Enable / Disable toggle adjacent to the Profile Name

### 5.2.3.2.9. Delete Access Profile

Access Profiles that are no longer needed can be removed by clicking the Delete button adjacent to the profile name.

### 5.2.3.2.10. Profile Activity Notifications (Recurring)

Profile notifications notify the specified profile when an output has been activated by a specified event trigger.

## Add Notification

Adding this type of notification informs a destination profile when an event has taken place on a trigger's source profile.

To add a notification, please do the following:

1. Select the Device Name
2. Select Access Profiles
3. Click on Profile Activity Notifications
4. Click Add Notification
5. Select the source profile, the profile from which the trigger will take place
6. Select a Time Window
7. Select a Message
8. Select one or more of the types of notification, and click Next
9. Configure the Source Profile Output Activity, and click Next
10. Select the Destination Profile, and click Done
11. The Profile to Profile notification will now display in the list



FIGURE 82.



FIGURE 83.

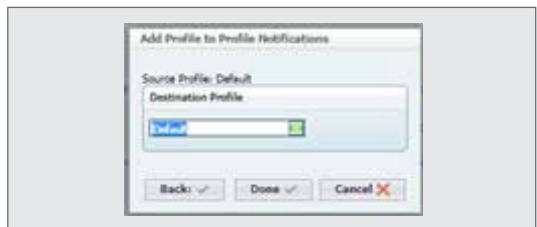

FIGURE 84.

### 5.2.3.2.11. Profile Activity Notifications (Once Off)

To configure the Once Off notification, do the following:

1. Select the Device Name
2. Select Access Profiles
3. Click on Profile Activity Notifications
4. Under Profile Activity Notifications Once Off

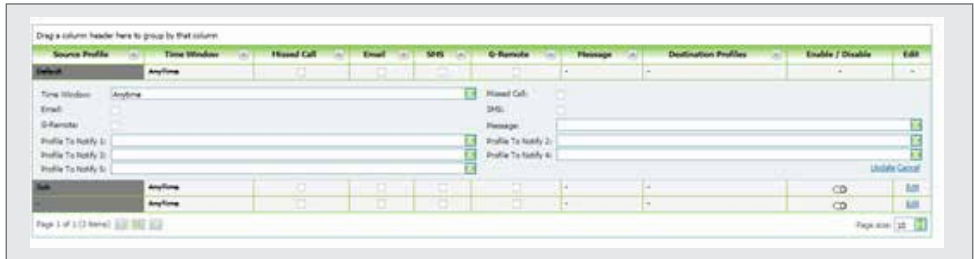

FIGURE 85.

5. Enable the notification, and click Edit
  - a. Select a Time Window
  - b. Select the Delivery Medium
  - c. Optionally enable Missed Call for inbound call notification
  - d. Enter a custom text message into the Message field
  - e. Select one or up to five profiles to be notified
6. Click Update to save the changes

## Messages

The feature enables the activation of an output when a Please Call Me or an SMS is sent to the device.



Configuration depends on available outputs and a Time Window. Ensure that outputs have been configured and a Time Window has been configured.

## Please Call Me Activation

The Please Call Me Activation performs a preconfigured action when a Please Call Me is sent to the number of the SIM card on the device.

To configure the Please Call Me Activation, do the following:

1. Select the device name
2. Select Access Profile
3. Click on the Activations icon adjacent to the Profile Name
4. Click on Messages

5. Enable the Please Call Me activation, and click Edit
6. Select an output that will be activated
7. Select a Time Window
8. Click update to save the configuration

### SMS Messages Activations

Configure a custom SMS message to activate a selected output. The text message is then sent to the device via SMS and the device activates the selected output.

To configure the SMS Message Activation, do the following:

1. Select the device name,
2. Select Access Profile
3. Click on the Activations icon adjacent to the Profile Name
4. Click on Messages
5. Enable an Incoming activation[x], and click Edit
6. Enter the custom message in the Message field
7. Select an IO to activate
8. Select a Time Window
9. Click Update to save the configuration

### 5.2.3.3. Settings

#### 5.2.3.3.1. IO Settings

There are four general purpose IOs which can be configured as either input or outputs. They are complemented by two relay IOs which are mechanical and are best used to switch a high-current or high-voltage load



IO4 supports a special feature as a gate monitoring input. This is used in conjunction with the G-REMOTE gate monitoring template which enables the gate status to be proactively monitored.

Specify the IO directions and logical names

IO	Name	Direction	Edit
1	Status	Input	Edit
2	Alarm	Input	Edit
3	Output 3	Output	Edit
4	Gate Status	Input	Edit

Enable Gate Status Monitor on IO4

IO	Name	Direction	Edit
5	Arm/Disarm	Output	Edit
6	Output 6	Output	Edit

[Go To Advanced IO Settings](#)

FIGURE 86.



## Configure an IO

To configure an IO, do the following:

1. Select an IO, 1 through 4 from the list
2. Click Edit
3. Select the Direction from the drop down as either Input / Output
4. Enter a name that will uniquely identify the IO
5. Click Update to save the changes



An IO configuration change requires the device to be synced

## Enable gate status monitoring

To configure IO 4, do the following:

1. Enable the check box Enable Gate Status Monitor on IO4



An IO configuration change requires the device to be synced

## Configure an IO (relay)



Relays are mechanical switches that have a normally- open and normally- closed contact. This enables the switching to either switch something that is on off or something that is off on. To implement this correctly, ensure that you have consulted your wiring diagrams before configuration.

To configure the relay, do the following

1. Select IO5 or IO6, and click Edit
2. Enter a Name, which uniquely identifies the IO
3. Click Update to save the changes



To configure the relay switching, go to Advanced IO Settings

### 5.2.3.3.2. Advanced IO Settings

#### Falling and Rising Edge Settings

For each input, the user can configure the settings as discussed here.



The following explanation applies to both the rising and falling edge attributes of an input signal.

IO Number	Name	Event Counter	Filter Time	Filter Unit	Blanking Time	Blanking Unit	Only Trigger IF Rising Filter Time is Reached	Falling State Name	Edit
1	Status	0	1	Seconds	0	Seconds	<input checked="" type="checkbox"/>	Armed	
2	Alarm	0	1	Seconds	0	Seconds	<input type="checkbox"/>	Intruder	Edit
4	Gate Status	0	1	Seconds	0	Seconds	<input type="checkbox"/>	Off	Edit

FIGURE 87.

Setting	Description
Name	The name of the IO as defined when the IO was configured. To change the name, this can be done in the IO settings page.
Filter Time	An input signal may be accompanied by several unwanted pulses. The Filter Time sets the number of units of time for the signal to be considered settled.
Blanking Time	Once the signal has settled, the Blanking Time determines from when action would be taken, after the input signal has settled
Only Trigger	A trigger or change will only be effected if the change in input signal takes place within the time allotted by the Filter Time. If the change takes too long, i.e. exceeds the Filter Time, then a change in state would not be acknowledged.
Event Counter	The number of events before action is taken.
Filter Unit	The unit of time for the Filter Time.
Blanking Unit	The unit of time for the Blanking Time.
Falling State Name	The rising / falling edge indicates a change in the status of the input signal which is indicated by a change in the status on G-REMOTE.

TABLE 17.

## How to set Falling Edge / Rising Edge



Please ensure that you have first configured an IO as an input as these settings only apply to inputs

1. Click on the device name under My Devices
2. Select an IO and then click Edit
3. Enter a Filter Time, or use the up/down arrows to increment / decrement the time
4. Enter a Blanking time, or use the up/ down arrows to increment / decrement the time
5. Enable or Disable the Only Trigger IF Rising Filter Time is Reached check box. The default is enabled
6. Enter an Event Counter value, or use the up/ down arrows to increment / decrement the value
7. Select the Filter Unit value using the drop down; the default is Seconds
8. Select the Blanking Unit value using the drop down; the default is Seconds
9. Enter a Falling / Rising State Name
10. Click Update to save the settings and the changes will be synced to the device

## Configuring Output Channels

IO Number	Name	Latched	Pulse Time	Pulsed Unit	Restore Output State On Power Up	ON State Name	OFF State Name	Edit
3	Output 3	<input type="checkbox"/>	1	Seconds	<input type="checkbox"/>	PULSED	OFF	
5	Arm/Disarm	<input type="checkbox"/>	2	Seconds	<input checked="" type="checkbox"/>	PULSED	Disarmed	Edit
6	Output 6	<input type="checkbox"/>	1	Seconds	<input type="checkbox"/>	ON	OFF	Edit

FIGURE 88.



The setting below applies to both the IO (IO1 – IO4, if configured as outputs) and IO5 & IO6 as relays

Setting	Description
IO Number	The IO designation.
Name	The custom name allocated to the IO.
Pulse Time	The Time value in the unit specified that the relay state will be pulsed.
Restore state on power up	The last "state" of the IO will be restored after a power failure, or after power is restored to the device  NOTE: The implications of a device being restored, and relay being activated must be carefully considered before enabling this option if it may pose a safety or security risk.

TABLE 18.

Setting	Description
OFF State Name	A custom name that describes the state of the IO in the Off State.
Latched	Optional configuration setting for the relay to be switched and stay in that state until changed. NOTE: If Latched is disabled, i.e., not checked, then Pulse is enabled.
Pulsed Unit	The unit of time that the Pulse Time is configured using.
ON State Name	A custom name that describes the state of the IO in the On State.

TABLE 19.

### How to Configure an Output Channel as Latched

1. Select an IO to configure, by clicking Edit
2. Enable the Latched check box
3. Enter an OFF State Name
4. Enter an ON State Name
5. Click Update, and a sync with the device is required

### How to Configure an Output Channel as Pulsed

1. Select an IO to configure, by clicking Edit
2. Ensure that the Latched check box is disabled
3. Select a pulse unit by clicking on the drop down
4. Enter an ON State Name
5. Enter a Pulse Time manually, or use the increment / decrement arrows to adjust the value
6. Enter an OFF State Name
7. Click Update to save the settings and a sync is required with the device

#### 5.2.3.3.3. Time Window

The Time Windows are customisable time periods which are applied to Activation Schedules, IO Mappings, Profile notifications and Activations.

#### Add a Time Window

To Add a Time Window, do the following:

1. Click the device name
2. Click Add Time Window
3. For the New Time Window:
  - a. Enter a description
  - b. Select one or more days
  - c. Select a From time for the window
  - d. Select a To time for the window
4. Click Save, and the new time window will appear in the list



FIGURE 89.

## Edit A Time Window

To Edit a Time Window, do the following:

1. Click the device name
2. Locate the Time Window to Edit
3. Click the Edit icon and proceed through the steps making changes as required

## Enable / Disable A Time Window

To Enable/Disable a time window, do the following:

1. Click the device name
2. Locate the Time Window to Enable / Disable
3. Click the slider to enable / disable the Time Window as required

## Delete A Time Window

To Delete a Time Window, do the following:

1. Click the device name
2. Locate the Time Window to delete
3. Click the slider to delete the Time Window as required

### 5.2.3.3.4. IO Mappings

Map an input to trigger one or more outputs. An IO must be configured as an input, and this serves as the trigger for the event.

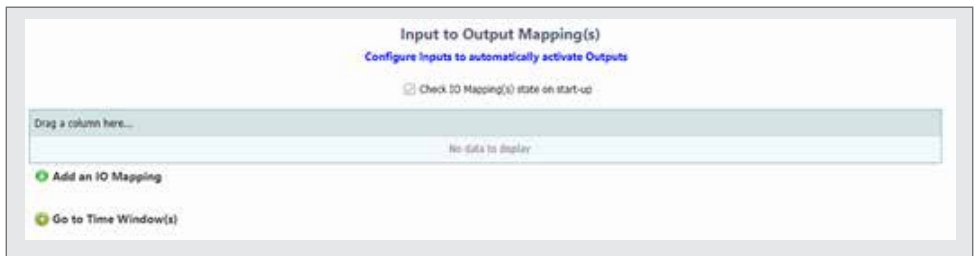

FIGURE 90.

### Add an IO Mapping

To add an IO mapping, do the following

1. Click on the device name, and then select IO Mappings
2. Select an input from the drop down, and then click Next

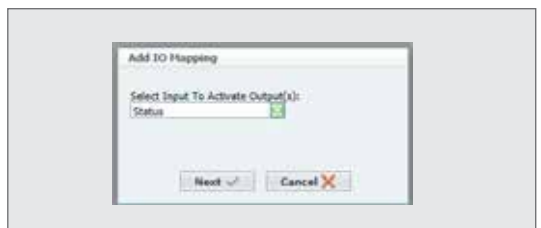

FIGURE 91.

3. Select the Rising Edge Action Time Window, and select the output's action from the drop down

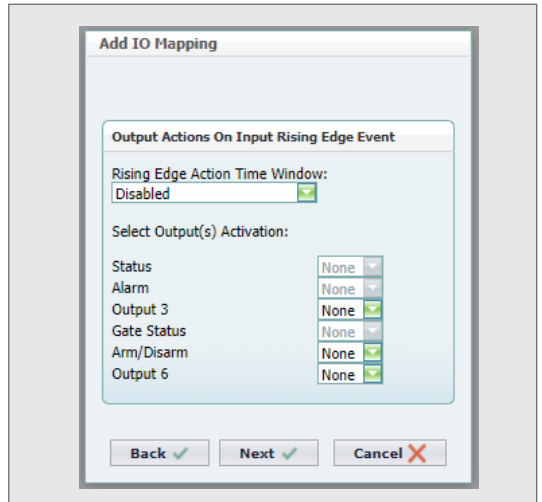

FIGURE 92.

4. Select the output Actions on the Input falling edge event, and the action for the output
5. Click Done, and the new IO Mapping will be present in the list

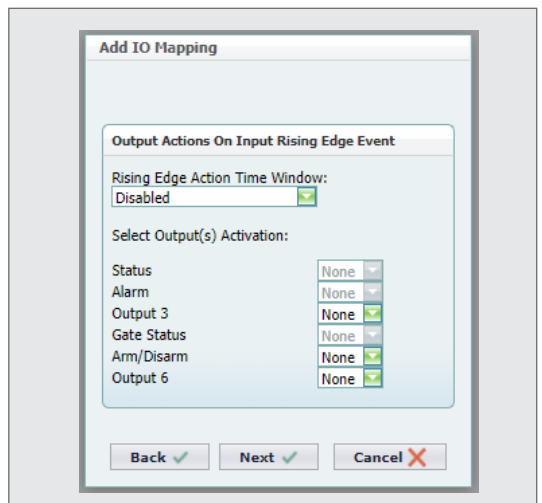

FIGURE 93.

## Edit an IO Mapping



FIGURE 94.

To Edit the IO Mapping, do the following

1. Click on the device name, and then select IO Mappings
2. Locate the mapping to edit and click the Edit icon
3. Click through the steps and make the changes as required

## Delete an IO Mapping

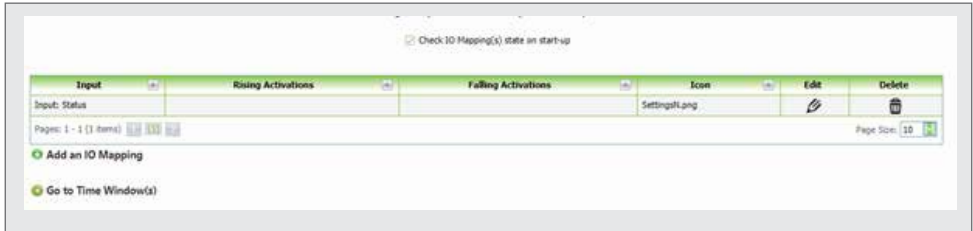

FIGURE 95.

To Delete the IO Mapping, do the following:

1. Click on the device name, and then select IO Mappings
2. Locate the mapping to delete and click the Delete icon
3. The IO mapping will be removed

### 5.2.3.3.5. Output Activation Schedule

The schedule enables the user to configure the automated activation of outputs based on a Time Window. An example would be the locking and unlocking of a gate during business hours and enabling an exclusion for weekends.

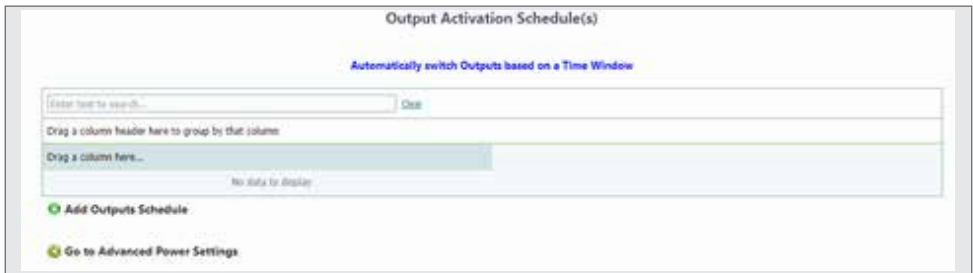

FIGURE 96.

## Add Output Schedule



Ensure that you have created a Time Window, which is a prerequisite.

### Output Schedule

To create an Output Activation Schedule, do the following:

1. Click on the Device name
2. Create a Time Window
3. Click Output Activation Schedule
4. Select a Time Window from the drop down, and enter a description

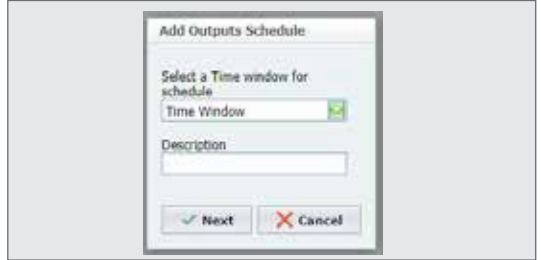

FIGURE 97.

5. Click Next
6. Select one or more outputs to activate for exclusion Start, and click Next

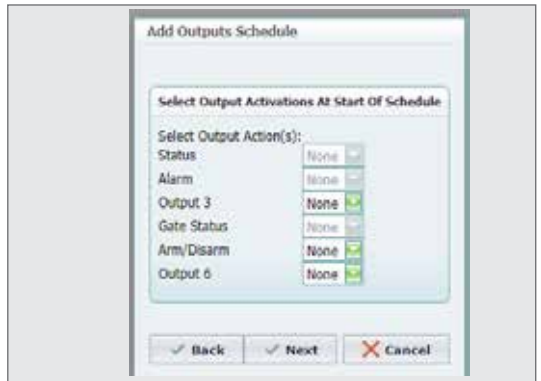

FIGURE 98.

7. Select one or more outputs to activate for exclusion End, and click Next

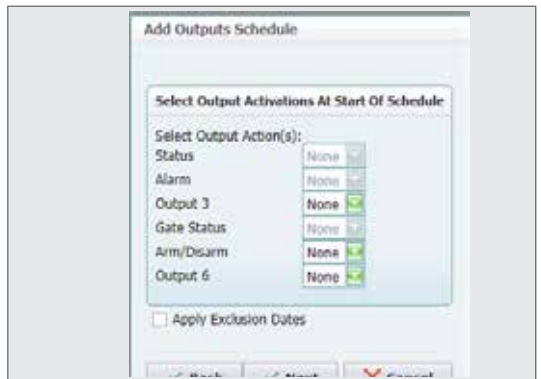

FIGURE 99.



### 5.2.3.3.6. Exclusion Dates

An exclusion date is used to disable a Scheduled Activation for a specific day.

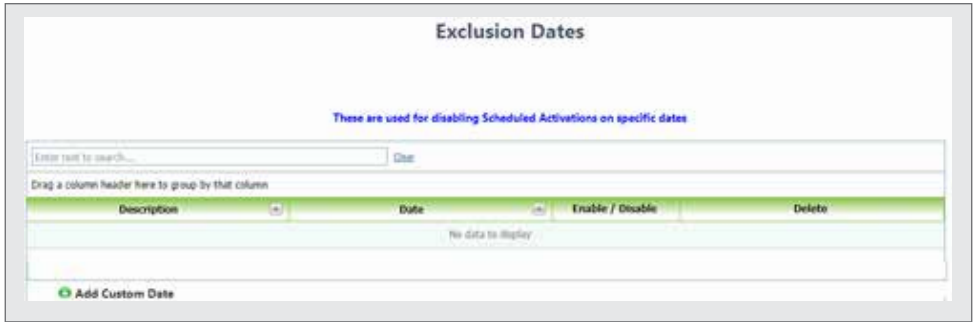

FIGURE 100.

To view and configure the Exclusion Dates, do the following:

1. Click the device name
2. Select Exclusion Dates
3. Click Add Custom Date
4. Enter a description
5. Click Done to complete or Cancel to abort

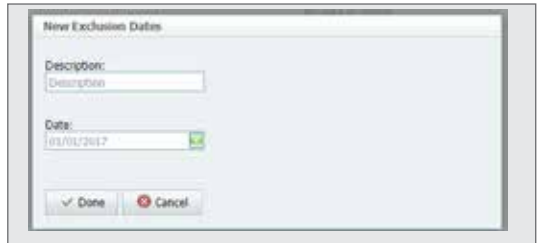

FIGURE 101.

### 5.2.3.3.7. Advanced Power Settings

The Advanced Power Settings enable the backup battery to be monitored. This advanced feature will ensure that the selected device remains in operation, by monitoring its supply especially during a power outage or an event when the mains power is interrupted.

To view and configure the Advanced Power Settings for the following:

1. Click the device name
2. Select Advanced Power Settings
3. Enable Battery Supply Monitoring
4. Select the battery voltage



FIGURE 102.



Ensure that the correct voltage rating is selected as this will impact on the monitoring levels

## 5.3. G-WEB App

### 5.3.1. Installation

To install the app on your phone, do the following:

1. Use a QR Code reader to browse to the online app store
2. From your phone, open the Google Play store and enter the product name "G-WEB" into the search box
3. When located, tap on it and click the green button labeled Install
4. Follow the onscreen prompts, if any and then open the app

### 5.3.2. Adding a Device

1. On the bottom right-hand corner of the screen, locate the GREEN + and press it
2. The Add New Device window will appear
3. To add the device manually, copy the details for the device off the box it came in into the fields
  - a.IMEI
  - b.Password
  - c.Name: Give the device a name so that you can identify it from any other devices you add in future
  - d.Click Add
4. To use the QR Code option, press the QR Code scanner button on the top right-hand side of the window
  - a. The QR Code scanner window will open
  - b. Locate the QR-Code on the box that the device came in
  - c. Scan the code
5. The device will now list on the home screen and you will be able to see
  - a. The custom name that you provided
  - b. The CELL number of the device's SIM card
  - c. The type of device, whether it is a **G-ULTRA** or a G-SPEAK



Configuration and setup of the G-SPEAK is beyond the scope of this manual.

### 5.3.3. Device Options

To view Device Options, tap any device in the listing and the device's options will list.

Option	Description
Configure	Enables custom configuration of the device.
Wizard	A set of Wizards for template-based configuration of the Device.
Clone	Allows you to clone the configuration of an existing device to a new device.
Transfer Device	Associate this device with another profile, i.e. sharing the device.
Add Secondary User	Add additional users to enable access to the device.
Delete	Deletes the current device.

FIGURE 103.

TABLE 20.

#### 5.3.3.1. Configure Device

Tap a device in the list, and then tap Configure.

##### 5.3.3.1.1. Back

Tap to return to the previous menu.

##### 5.3.3.1.2. Info

The device's information will be displayed

#### Device Details

To change the device's details, do the following:

1. Locate the link labelled Edit, and tap it
2. Enter a new Name, which will update the device with a new name
3. Enter a new password, which will change the existing one
4. Tap Save to confirm the changes or Cancel to undo them
5. To return to the previous window, tap the green navigation icon in the top left-hand corner and select Back.

#### Connectivity Details

These details cannot be changed, and are the details of the individual device's network connection and other details. If any of the attributes have no information listed, tap the Refresh link to update them.

Item	Description
Network	MTN, if you have retained the original SIM card or the network of the current SIM.
Data Connection	The network type which is currently either 2G/3G.
Antenna	This is set at the device to be either internal or external.
Signal Strength	The signal strength the device has to the network.
Supply Voltage	The voltage supplied to the device by the power supply.

TABLE 21.

To return to the previous window, tap the green navigation icon in the top left-hand corner and select Back.

### Device Tokens Remaining

The tokens are important as this provides the device with network access for outgoing notifications and SMS. If these are zero, then the device will not be able to send notifications. Ensure to recharge or maintain a recharged level.

If no details are listed, tap the Refresh link

To Purchase tokens, tap the Purchase icon

To Set Low Thresholds tap the Low Thresholds link.

To return to the previous window, tap the green navigation icon in the top left-hand corner and select Back

### Firmware Details

The Firmware is the software loaded onto the device which enables it to operate. This software may be updated from time to time as new features become available or enhancements are provided.

To return to the previous window, tap the green navigation icon in the top left-hand corner and select Back.



Enable Automatic Updates is enabled by default. Retaining this ensures that the **G-ULTRA** device is updated if / when new updates are available.

### 5.3.3.1.3. Access Numbers

Adding a new number enables the number to have access to the device. To add a new number, do the following:

1. Tap the green Add icon in the lower right-hand corner of the screen
2. Enter the Name of the person who owns the number, or select the person from the Contacts List by tapping the Contacts icon
3. Keep the country code at +27
4. Enter the number in the Number field
5. Enter the User Email address
6. Select a profile; this would be the current profile or profiles that you have access to
7. You may also
  - a. Add to your contacts if this number is new
  - b. Send a welcome SMS.
    - i. If selected, enter a custom welcome message, or use the default
    - ii. Configure them as a visitor and, if selected, configure their visitor access time
      1. Select a Date From, and the time on that Date to enable access
      2. Select a Date to, and the time on that Date to disable access
    - iii. You may also delete the number if this is a once-off requirement
8. Click Done, when done

### 5.3.3.1.4. Access Profiles

All profiles you have access to are listed here, including the default profile which is the Administrator profile. A profile is created to add Users to and provide them with access to devices.

#### Adding a new profile

To Add a profile, do the following:

1. Tap on the device, and tap Access Profile
2. Tap the green Add profile button in the lower right-hand corner
3. Enter a name for the profile
4. Set this profile as Administrator, default is not administrator

#### Editing the Profile

1. Tap on the Device, and tap Access Profile
2. Tap the profile to be edited
3. Select the Edit option
4. Edit the name
5. Edit the permissions to Administrator or disable Administrator
6. Tap Save to confirm or cancel to exit

**Disable / Enable**

1. Tap on the device, and tap Access Profile
2. Tap the profile to toggle Enabled / Disabled

**Delete A profile**

1. Tap on the device, and tap Access Profile
2. Tap the profile to be deleted
3. Tap Yes to confirm or No to exit

**5.3.3.1.5. Sync**

Syncing the device to G-WEB updates any changes to the device.

To sync the device, do the following:

1. Tap on the device to be Synced
2. Tap Configuration Options
3. Tap Sync
4. The Sync is performed, and a report returned to the window

**5.3.3.1.6. Logs**

The logs retain the system activity information.

To view the logs, do the following:

1. Tap on the device to access its logs
2. Tap Configure Options
3. Tap Logs
4. Under Sync Configuration
  - a. Enable Sync Logs in Batches, on leave disabled
  - b. Delete Frequency: Select the frequency that you want to retain, i.e. the delete is every 3, 6 or 12 months
5. Visible Categories: Default is for all types of log event categories to be displayed. Disable the ones not required
6. Tap Sync Now to retrieve the logs
7. The logs will display below, with a time stamp for each log event, description of the event and log data

**5.3.3.1.7. Settings****IOs**

The IO settings configure the IO that each **G-ULTRA** has. There are two types: solid- state and mechanical (relay).

**Configure IO**

To configure a solid-state IO, do the following:

1. Tap Settings, and then IOs
2. Select 1 – 4 for solid- state, by tapping on it
3. Tap Configure
4. Select the IO direction, using the green slider
5. Under Names
  - a. Enter an IO name
  - b. Enter the text to describe the 'High' state
  - c. Enter the text to describe the 'Low' state
6. To Set Filter times, tap the link
7. Tap Save to retain the configuration
8. To cancel, Tap the red X

**Configure a relay output**

To configure a relay IO, do the following:

1. Tap Settings, and then IOs
2. Select 5 or 6 for solid- state, by tapping on it
3. Tap Configure, and from the Relay X Settings
  - a. Enter a custom name for the IO
  - b. Enter an ON-State Name
  - c. Enter an Off-State Name
4. Tap Switch Options
  - a. Select either Pulsed or Latched by moving the slider
  - b. If Pulsed is chosen (ON for a set time and then goes off), do the following:
    - i. Select the unit of time, for example seconds, by using the drop down
    - ii. Either enter the value or use the up and down buttons to change the value
    - iii. Tap Save
  - c. If Latched was selected, tap Save

## Configure A Button



The Button configuration only applies to an IO set as an output or a relay output

To configure a Button, do the following:

1. Tap on an IO configured as an output or a relay
2. Tap G-REMOTE
3. In the Icon drop-down, select the Icon
4. To set button Colour, tap Colours
5. Select a colour for the two states listed



Custom naming may have been applied to the two states;, however, the two states are usually armed or disarmed and On / OFF. Select colours that correspond to the states as they apply

## Disable / Enable

To Enable or Disable an IO, do the following:



This feature toggles the setting

1. Tap on the IO
2. Select Disable / Enable
3. The selected IO will change from its previous state of Enabled/ Disabled to the new state of Disabled/ Enabled
4. The I/I will have a no entry symbol on the IO indicating that it is not available.



Disabling an IO will remove it from the G-REMOTE for the respective **G-ULTRA** device.

## IO Mapping

An IO mapping requires at least one of the IOs to be configured as an input so that it can be used as a trigger or event for an output. The output may be one of the other 3 remaining IOs or one of the relays.

To Configure an IO mapping, do the following:

1. Tap Settings
2. Tap IO Mapping
3. Tap the green "Add Mapping" icon
4. From the Add IO mapping, select an Input from the drop down, and then tap Next



5. Select one or more outputs for the Falling Edge transition (High to Low) by tapping on the drop down adjacent to the output and selecting the action
  - a. ON
  - b. OFF
  - c. ON/OFF
6. Select one or more outputs for the Rising Edge transition (Low to High) by tapping on the drop down adjacent to the output and selecting the action
  - a. ON
  - b. OFF
  - c. ON/OFF
7. When this is complete, the IO mapping will display

### **Editing / Deleting IO Mapping**

To Edit / Delete an IO mapping:

1. Tap Settings
2. Tap IO Mapping
3. Tap the Settings icon
4. Tap Edit, and the IO Mapping routine is followed, or
5. Tap Delete and then tap Yes to confirm deletion

### **Power Saving**

Enables Power Saving Mode; the default is disabled.

To enable Power Saving, do the following:

1. Tap the green slider to enable Power Saving
2. Tap to select Supply Battery Voltage. Verify this on the battery before selecting
3. Tap Activate
4. Tap Confirm



Ensure to read the notification before tapping Confirm

#### **5.3.3.1.8. Scheduled Activations**

This feature sets a day of the week and time to activate / deactivate the specified IO.

To Schedule an Activation, do the following:

1. Configuration Options, Tap Scheduled Activations
2. Scheduled Activations, again and then tap the green "Add Activation" icon
3. Enter a Name for the activation
4. Tap the sliders to select one or more days of the week

5. Enter a start time
6. Enter an end time, and tap Next
7. Tap the green, right-facing arrow to change the setting for the outputs
8. Tap Done, and you will return to the Output Activation Schedule List that you have now created

#### 5.3.3.1.9. Exclusion Dates

This feature sets a day of the week and time to that is excluded.

To Schedule an Exclusion, do the following:

1. Configuration Options, tap Scheduled Activations
2. Scheduled Activations, again and then tap the green “Add Exclusion” icon
3. Tap Custom Date
  - a. Enter a description
  - b. Enter a date
  - c. Tap Done

#### 5.3.3.1.10. SMS Commands

Sending SMS commands to the **G-ULTRA** is done by the app accessing the SMS function of the mobile device. A template SMS is prepared, and the user actions the SMS by tapping Send.

FIGURE 103.

Item	Description	Outcome
Reboot device	Reboots the <b>G-ULTRA</b>	Device will reboot and remain unavailable during the reboot cycle.
Format Device	Format Device	
Device Status	Status of device	Returns the status of the device, voltage level and FW version
IO Status	Status of the <b>G-ULTRA</b> 's IO	Returns the current state of the IO on the device
Balance Recharge	Recharge the device's balance	Sends commands and returns with recharge
RUN USSD	Runs a USSD code	Runs the USSD Code specified

TABLE 22.

#### How to send commands

To send commands to the **G-ULTRA** via SMS, do the following:

1. Select the **G-ULTRA** by tapping on the device
2. From Configuration Options, tap SMS Commands
3. Select the command from the options available
4. The mobile device's SMS app will open with a prepared SMS, and it does not send until the user actions send

5. Wait a few moments for a response, and the **G-ULTRA** returns with the response to the specific SMS command

#### **5.3.3.1.11. Time Periods History**

Time Periods are customisable time periods during which existing activations and notifications won't be sent.

##### **How to add a time period**

To Add a time period, do the following:

1. From Configuration Options, tap Time Periods
2. Tap the green "Add" icon
3. Enter a Description
4. Select one or more days of the week using the sliders
5. Select whether the Block will happen during the time period or outside of it using the Invert Time Period slider
6. Enter a Start time
7. Enter an End time
8. Tap Done, and you will return to the Time Periods list

#### **5.3.3.1.12. History Logs**

1. From Configuration Options, tap History
2. View the log by scrolling down, and tapping the available page numbers to index through the logs

#### **5.3.3.1.13. Support**

To access support do the following:

1. From Configuration Options, tap support
2. For the Type of Device Issue, tap on the drop down and select an issue from the list
3. Enter details to further detail the problems you are experiencing
4. Tap request support

#### **5.3.3.2. Wizard**

G-WEB Mobile includes Wizards which assist the Administrator in quick and effective configuration of the target **G-ULTRA** device. If a Wizard is run on a **G-ULTRA** that is already configured, the Wizard will overwrite the existing configuration, and at the same time update G-REMOTE with the new Buttons configuration.

The Wizards are essentially configuring the IO usage and implementation. Once you have chosen a wizard and applied it you will be required to implement the physical wiring configuration to support the implementation that you have chosen.

Wizard Template Options		
Gate	Configures a single gate with the following, button descriptions below.	
	Open	Opens the gate completely and then closes
	Pedestrian	Opens the gate sufficiently to allow a pedestrian and then closes.
	Keep Open	Gate is open, and remains open until closed.
	Lock	Locks the gate.
Electric Fence	Status	Status of the fence.
	Siren Status	Siren is active or not.
	Arm / Disarm	Switches the fence on or off.
Alarm	Siren Status	Siren is active or not.
	Alarm	
	Arm / Disarm	Arms or Disarms the alarm configuration.

TABLE 23.

### 5.3.3.2.1. Device Application Wizard

To use the Wizard, do the following:

1. Tap on the device that will be the target of the Wizard
2. On the Device Options Wizard, select Wizard
3. The Device Application Wizard, locate the drop down below the title Application. Select an option from the drop down



The wiring diagram for the options available is available from this window in the lower left-hand corner

4. Tap Next
5. Select I / O Used: Compare the wiring diagram with the IO listed and select the ones to disable. The default is to retain all suggested usage
6. Tap Next
7. Status Notifications: Select the status notifications to be sent to the G-REMOTE users which are associated with the current profile. The default setting is all disabled
8. Click Apply
9. Once Apply is tapped, there are two outcomes
  - a. If there are any existing users who have access to the **G-ULTRA** that has been updated, their G-REMOTE app on their phones will be updated with the new Button configuration
  - b. To conclude the Wizard, the user can now add additional users by adding their telephone numbers by tapping the link Configure > Access Numbers
10. Alternatively, click OK to complete the process

### 5.3.3.3. Clone Device



Prerequisite check: Ensure that you have at least two devices listed, and one has been pre-configured

To clone a device, do the following:

1. Tap the device that is the source to clone from in the device listing
2. On the Device Options menu, tap Clone Device
3. A window will prompt you to select a Device to clone to; tap Proceed
4. Select the device to clone to by tapping on it
5. Select Next to proceed

### 5.3.3.4. Transfer Device



Prerequisite check: Ensure that you have the details of the profile to which you want to transfer the device to

To transfer the device, do the following:

1. Tap the device, which is the device to be transferred
2. Select Transfer Device
3. Enter the email address of your account to validate the transfer and tap the link Validate
4. Once the address has been validated, tap the link Request Transfer



Device transfer may be affected by network coverage as the device being transferred needs to be synced.

### 5.3.3.5. Add Secondary User



Prerequisite check: Ensure that you have the details of the profile to which you want to transfer the device to

To add a secondary User, do the following:

1. Tap the device to which the Secondary user will have access
2. Tap Add Secondary user
3. Enter the email address of the secondary user, and tap Validate.
4. Select the permissions that the user will have
5. Tap Add User

### 5.3.3.6. Delete Device



Removing a device by deleting it, will remove the device from the current profile.

To Delete the device, do the following:

1. Tap the device which will be deleted
2. Confirm deletion by tapping Yes, or No to cancel
3. The device is deleted when Yes is tapped

## 6. G-REMOTE

### 6.1. Introduction

G-REMOTE is a mobile app installed on the mobile device of a user who has been given access. Access granted to them will enable them to activate outputs on the **G-ULTRA** they have access to and receive notifications from the same **G-ULTRA**.

### 6.2. Installing the App

G-REMOTE is available without charge from the online store for the operating system on your mobile device. Currently, Android and IOS devices are supported. Using a QR Code reader on your mobile device, scan the code and this will take you to the correct page from which to install the app



### 6.3. Using G-REMOTE

G-REMOTE is used to interact with various **G-ULTRA** devices; it is not a configuration tool. The Button and IO configuration is pushed to the G-REMOTE on your mobile device if the number of the mobile device has been added.

The menu options and features are described below.

### 6.3.1. G-REMOTE Landing Page / Favourites List

G-REMOTE is a mobile app installed on the mobile device of a user who has been given access. Access granted to them will enable them to activate outputs on the **G-ULTRA** they have access to and receive notifications from the same **G-ULTRA**.

#### 6.3.1.1. G-ULTRA Device Landing Page

The following options are available once a **G-ULTRA** device has been selected.







	G-REMOTE devices list.
	Tab through landing page menu options.
	Additional Settings.
	IO Configuration display. The IO configuration for the selected device is displayed in the form of buttons and notification indicators.
	Notifications from the <b>G-ULTRA</b> .
	<b>G-ULTRA</b> device information.
	Pre-configured SMS messages sent from the mobile device to retrieve data from the <b>G-ULTRA</b> or to send commands to the device.

TABLE 24.

### 6.3.2. Using and Customising Buttons



Activating a button requires that the **G-ULTRA** is online and may incur network costs depending on the SIM card in use.

#### 6.3.2.1. Activating the Button

To activate a button, do the following:

1. Tap the button, and wait for a moment
2. The button will change colour and the label will change to indicate the change of status



The button will only change status once a response is received from the **G-ULTRA** confirming that the action has taken place

### 6.3.2.2. Deactivate the Button

To deactivate the button, do the following:

1. Tap the button, and wait for a moment
2. The button will change colour and the label will change to indicate the change of status



The button will only change status once a response is received from the **G-ULTRA** confirming that the action had taken place

### 6.3.2.3. Add to Favourites

1. Tap and hold the button until the Button Actions popup displays
2. Tap, Add to Favourites

### 6.3.2.4. Enter a Name for the Button

1. Tap and hold the button until the Button Actions popup displays
2. Tap Name
3. Enter a button name
4. Tap Ok to confirm, or Cancel
5. You will be returned to the dashboard

### 6.3.2.5. Change the Button Colour



Changing the ARMED and DISARMED status colours is performed as a single action. If you are changing one colour, ensure to select the existing colour a second time.

To change the button colour, do the following:

1. Tap and hold the button until the Button Actions popup displays
2. Select Colour
3. Armed Colour: Select a colour from the list, you will be directed to the Disarmed Colour
4. Disarmed Colour: Select a colour from the list
5. You are now returned to the main Buttons dashboard for the current **G-ULTRA** device



If you tapped Cancel, this would have ended the colour change and no change would have been made to either button colour



### 6.3.2.6. Change Icon

To change the icon, do the following:

1. Tap and hold the button until the Button Actions popup displays
2. Tap Icon
3. Select a new Icon from the list provided
4. You will be returned to the main dashboard with the Icon updated

### 6.3.3. Input Actions

Input Actions appear on the bottom of the dashboard; if and when they are actioned, they will change colour the same as the buttons when activated. The same options are available to customise them as the buttons

See the following section on how to customise them:

### 6.3.4. Device Notifications

Device notifications list in the Device Notifications tab. They are time-stamped with a description of what triggered the event. They can be searched if a particular notification is required. The notifications will also appear as a notification to the mobile device and are received in the same way a weather notification is received.

Notifications may include when a **G-ULTRA** device is no longer online, the device is restored and other notifications that are configured using G-WEB



Receiving the notifications on your mobile device may require that the correct permissions be set when G-REMOTE is installed.

### 6.3.5. Information

Device information can be retrieved from the **G-ULTRA**. When the info is requested, the device is the source of the information and you will need to wait on the device to respond to network coverage and device connectivity.

#### 6.3.5.1. Device Info

To retrieve device info, do the following:

1. Tap the I icon
2. Tap the Refresh button
3. When the device responds, the information will be updated

### 6.3.6. Send Commands

Sending commands to the **G-ULTRA** is done by the app accessing the SMS function of the mobile device. A template SMS is prepared, and the user actions the SMS by tapping send.

Item	Description	Outcome
Reboot device	Reboots the <b>G-ULTRA</b>	Device will reboot and remain unavailable during the reboot cycle.
Format Device	Format Device	
Network Info	Requests network status information	Returns the service provider, signal strength, Network Type, etc.
Network Balance		
Device Status	Status of device	Returns the status of the device, Voltage level FW version.
IO Status	Status of the <b>G-ULTRA's</b> IO	
Balance Recharge	Recharge the device's balance	Sends commands and returns with recharge
RUN USSD	Runs a USSD code	Runs the USSD code specified

TABLE 25.

#### 6.3.6.1. How to Send Commands

To send commands to the G-ULTRA via SMS, do the following:

1. Select the **G-ULTRA** by tapping on the device
2. Scroll from right to left or tap the SMS icon
3. Select the command from the options available
4. The mobile device's SMS app will open with a prepared SMS, and it does not send until the user actions send
5. Wait a few moments for a response, and the **G-ULTRA** returns with the response to the specific SMS command

#### 6.1.3.7. Settings

The settings apply to 1) all devices, and 2) selected device. The option is to Enable or Disable, with disabled as the default setting.

#### 6.3.7.1. All Devices

Item	Description
Block all Push Notifications	Blocks the push notifications.
Security Lock	Secures the app; enter a 4-digit PIN to activate the feature.
Double Press Activation	A double tap will initiate the button action.

TABLE 26.

### 6.3.7.2. Selected Device

Item	Description
Notification Type	Selects the type of notification.
Device Name Text Speech	Reads out incoming notifications.
Message Text to Speech	Reads out the incoming notification message.

TABLE 27.

### How to Change Notification Type

To change the notification type, do the following:

1. Tap on the device
2. Tap on Settings
3. Tap on Notification Type
4. Select a notification
5. Tap the Back arrow in the top left-hand screen

### 6.3.8. Refresh Permissions

Normally the **G-ULTRA** will be refreshed once a change or an update takes place. In the event that this does not happen automatically, then the Refresh Permissions Option updates the device information located on the mobile device.

### 6.3.9. About

Tap the About link to retrieve information about the G-REMOTE application.

## 7. TROUBLESHOOTING

### 7.1. My Device is Not Connected to G-WEB

From time to time the unit may disconnect and there are several reasons

1. Network Outage
2. The device is not powered
  - a. Check Power Source
  - b. Check wire connections
3. The device does not have Airtime /Data



Airtime bundles are only valid for 30 days, and then expire

4. Opt In Out Of Bundle Rates USSD
  - a. (MTN) \*135# then option 6, then option 1, then option 1
  - b. (Run USSD) commands below.



FIGURE 104.









Connect with us on:

 [facebook.com/centurionsystems](https://facebook.com/centurionsystems)

 [YouTube.com/centurionsystems](https://YouTube.com/centurionsystems)

 [@askcenturion](https://twitter.com/askcenturion)

 [centurion.systems](https://centurion.systems)

Subscribe to the newsletter: [www.centsys.com/subscribe](https://www.centsys.com/subscribe)

Call Centurion Systems (Pty) Ltd • South Africa  
Head Office: +27 11 699 2400

Call Technical Support: +27 11 699 2481  
Monday to Friday: from 07h00 to 18h00 (GMT+2)  
Saturday: from 08h00 to 16h30 (GMT+2)

[www.centsys.com.au](https://www.centsys.com.au)

Call: 1300 CENTSYS (1300 236 879)

After Hours International Technical Support Call Centre  
**+27 11 699 2481 (16:00 to 02:00 - Australian Eastern Time)**

**E&OE Centurion Systems (Pty) Ltd reserves the right to change any product without prior notice**

All product and brand names in this document that are accompanied by the ® symbol are registered trademarks in South Africa and/or other countries, in favour of Centurion Systems (Pty) Ltd, South Africa.

The CENTURION and CENTSYS logos, all product and brand names in this document that are accompanied by the TM symbol are trademarks of Centurion Systems (Pty) Ltd, in South Africa and other territories; all rights are reserved. We invite you to contact us for further details.



Doc number: 1248.D.01.0001

[www.centsys.com](https://www.centsys.com)