



# Richmond Office Furniture

Furniture Catalogue | Volume 18 2022/2023

[www.richmondofficefurniture.com.au](http://www.richmondofficefurniture.com.au) | E:[info@richmondofficefurniture.com.au](mailto:info@richmondofficefurniture.com.au) | Ph:1300920996

WORKSTATIONS - FURNITURE - SEATING - STORAGE - ACCESSORIES

**RICHMOND**  
OFFICE FURNITURE



# CONTENTS

4-11	Reception and Lounge
12-15	Rapid Eternity
16-19	Deluxe Infinity
20-23	Deluxe Infinity & Eternity Accessories
24-27	SHUSH30+ <b>NEW</b>
28-30	BOOST+ <b>NEW</b>
31	Height Adjustable Solutions
32	Monitor Arms
33-35	Rapid Screen
36-38	Deluxe Rapid Span & Rapid Span
39-43	Rapid Worker <b>NEW</b>
44-45	Rapid Vibe
46-47	Softwiring
48-53	Tables
54-68	Chairs
69	Rapidline Upholstery <b>NEW</b>
70-71	Presentation
72-73	Screens <b>NEW</b>
74-75	Personal Storage
76-78	Steel Storage
79	Accessories
80-83	Lockers and Accessories

Your Rapidline product is delivered from distribution centres throughout Australia in Sydney, Melbourne, Brisbane, Perth and Adelaide, with a local customer service team in each location.

We not only deliver in these areas but also offer a full installation service.

Have a requirement for an office fitout?

Our in-house projects team can design any layout with Rapidline furniture specific to your requirements.

\*We cannot guarantee colours shown in this catalogue are the exact true representation of product colours.

\*Specifications subject to change.







# RECEPTION & LOUNGE

## URBAN RECEPTION COUNTER - URC NW/DW

### Dimensions :

Width	2200mm
Depth	800mm
Height	1150mm
Counter Height	750mm

### Finish :

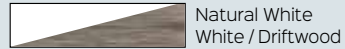

### Features :

- Driftwood wrap around cowl feature panel
- Built in lockable 3 drawer under-desk pedestal
- Built in CPU & storage cupboard
- 2 x chrome cable entry hole covers

### Certifications :



## MARQUEE RECEPTION COUNTER - MRC GW/ZB

### Dimensions :

Width	2400mm
Depth	835mm
Height	1150mm
Counter Height	750mm

### Finish :



### Features :

- Zebra veneer front columns
- Built in lockable 3 drawer under-desk pedestal
- Built in CPU & storage cupboard
- 2 x chrome cable entry hole covers with brush insulators

### Certifications :



## 5-O RECEPTION COUNTER - RC5-O GW

### Dimensions :

Width	2400mm
Depth	848mm
Height	1100mm
Counter Height	750mm

### Finish :



### Features :

- Chrome trim detail on front panel
- Large work surface
- 2 x chrome cable entry hole covers with brush insulators
- E0 Melamine board

### Certifications :



## RC1809 RECEPTION COUNTER - RC1809 NW

### Dimensions :

Width	1800mm
Depth	800mm
Height	1170mm
Counter Height	750mm

### Finish :



### Features :

- Black powdercoated perforated cowl
- Black matching kickplate
- E0 Melamine board

### Certifications :



## FLOW RECEPTION COUNTER - NCT1160

### Dimensions :

Overall Width x Depth	2400 x 1600mm
Worksurface Depth	800mm
Height	1160mm
Counter Height	730mm

### Finish :

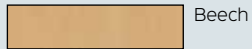

### Features :

- Curved reception counter
- Glass feature on side
- High reception hob for privacy
- Can be used as Left or Right hand return

### Certifications :



## RAPID BLOOM VERTICAL GARDEN - SRBVG BK | SRBVG WH

### Dimensions :

Width	395mm
Depth	210mm
Height	1940mm
Weight	34kg

### Features :

- 8 x 150mm diameter round pots
- 20kg of polished stones
- Wall & Floor mounting provisions
- \*Plants not included\*

### Finish Options :

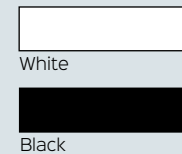

### Certifications :



## MODULAR RECEPTION COUNTER - MOD1NW | MOD2NW

### MOD1NW · Full Height Module

Width	1339mm
Depth	800mm
Height	1160mm
Counter Height	730mm

### MOD2NW · Glass Top Module

Width	1339mm
Depth	800mm
Height	935mm
Counter Height	730mm

### Finish :

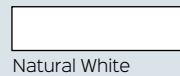

### Certifications :



### Features :

- Mix and match modular peices to suit your space
- E0 Melamine board



## SEMPRE RECEPTION COUNTER - SEMPRE

### Dimensions :

Width x Depth	2400mm x 950mm
Height	1150mm
Counter Height	730mm

### Features :

- Melamine feature module, powdercoat aluminium strips
- 500mm W x 50mm D Scallop cutout in work top
- Semi assembled, slide-together design
- Support rail under work top

### Finish Options :

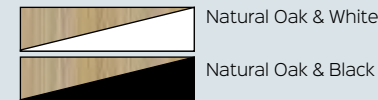

### Certifications :





# RECEPTION & LOUNGE

Flexi Lounge allows you to create a lounge area your way. Mix and match sizes and colours along walls, around corners or in the middle of a space.

## Finish Options :



Light Blue



Charcoal Ash

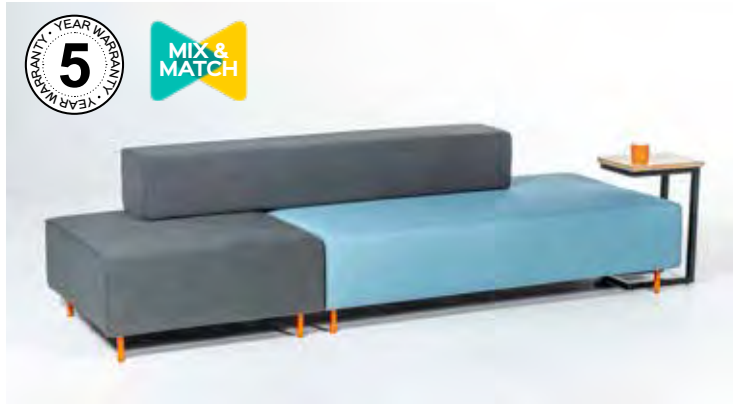

## FLEXI MODULAR LOUNGE

SINGLE SEAT AND BACK REST - FL1

925mm W x 940mm D x 710mm H



TRIPLE SEAT AND BACK REST - FL2

1830mm W x 940mm D x 710mm H



SINGLE BACK TO BACK - FL3

925mm W x 1880mm D x 710mm H



TRIPLE BACK TO BACK - FL4

1830mm W x 1880mm D x 710mm H



STRETCH - FL5

2755mm W x 940mm D x 710mm H



RETURN LOUNGE - FLRL

1245mm W x 585mm D x 430mm H



CORNER - FL6

2770mm W x 1830mm D x 710mm H



ISLAND - FL7

2755mm W x 1880mm D x 710mm H



## MARS ROUND OTTOMAN - MARS R

### Dimensions :

Diameter	550mm
Height	450mm
Weight Rating	130kg

### Features :

- Soft fabric upholstery
- Concealed black feet
- Match with square and triangle Mars ottomans

### Finish Options :



### Certifications :



\*Standard Charcoal



\*Pictured in Essence Fabric Surface textiles, Yarra Range

## MARS SQUARE OTTOMAN - MARS S

### Dimensions :

Width	550mm
Depth	550mm
Height	450mm
Weight Rating	130kg

### Features :

- Soft fabric upholstery
- Concealed black feet
- Match with round and triangle Mars ottomans

### Finish Options :



### Certifications :



\*Standard Charcoal



\*Pictured in Mist Fabric Surface textiles, Yarra Range

## MARS TRIANGLE OTTOMAN - MARS T

### Dimensions :

Overall Width	550mm
Overall Depth	485mm
Height	450mm
Weight Rating	130kg

### Features :

- Soft fabric upholstery
- Concealed black feet
- Match with square and round Mars ottomans

### Finish Options :

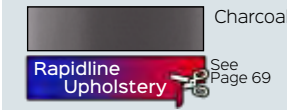

### Certifications :



\*Standard Charcoal



\*Pictured in Seafoam Fabric Surface textiles, Yarra Range

## CONNECT 2 OTTOMAN - CONNECT2

### Dimensions :

Diameter	320mm
Height	420mm
Weight Rating	110kg

### Features :

- Steel underbase storage
- Upholstered seat cushion
- Can be upholstered in house fabrics

### Finish Options :

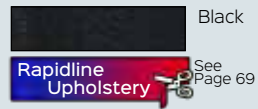

### Certifications :



\*Standard Black



\*Pictured in Steel Fabric Surface textiles, Yarra Range

## CARDINAL SINGLE LOUNGE - CSA

### Dimensions :

Overall W x D x H	755 x 800 x 880mm
Seat W x D x H	450 x 480 x 450mm
Back W x H	700 x 530mm
Weight Rating	Up to 150kg

### Finish Options :

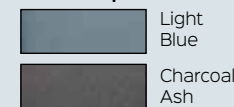

### Certifications :



### Features :

- Full fabric upholstery
- Removable seat & back cushion
- Powdercoated solid tube frame



## CARDINAL TWO SEATER LOUNGE - CSA2

### Dimensions :

Overall W x D x H	1335 x 800 x 880mm
Seat W x D x H	960 x 500 x 430mm
Back W x H	960 x 530mm
Weight Rating	Up to 200kg

### Finish Options :

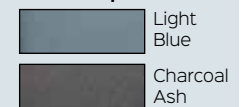

### Certifications :



### Features :

- Full fabric upholstery
- Removable seat & back cushion
- Powdercoated solid tube frame



# RECEPTION & LOUNGE

## SINGLE LOUNGE SEAT - SPACE1

### Dimensions :

Overall W x D x H	885 x 720 x 710mm
Seat W x D x H	550 x 515 x 445mm
Back W x D x H	570 x 120 x 310mm
Weight Rating	Up to 150kg

### Finish :

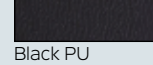

### Certifications :



### Features :

- Soft, comfortable single lounge
- Black polyurethane finish
- Stylish chrome wrap around frame



## TWO SEATER LOUNGE - SPACE2

### Dimensions :

Overall W x D x H	1140 x 720 x 710mm
Seat W x D x H	1110 x 515 x 445mm
Back W x D x H	1110 x 120 x 310mm
Weight Rating	Up to 200kg

### Finish :

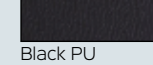

### Certifications :



### Features :

- Available in 2 other matching sizes
- Two seater lounge
- Modern, comfortable seating



## THREE SEATER LOUNGE - SPACE3

### Dimensions :

Overall W x D x H	1960 x 720 x 710mm
Seat W x D x H	1670 x 515 x 445mm
Back W x D x H	1670 x 120 x 310mm
Weight Rating	Up to 300kg

### Finish :

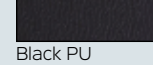

### Certifications :



### Features :

- Easy cleaning and maintenance
- Spacious 3 seater lounge



## CAPRI 1 SEATER - CAPRI1

### Dimensions :

Overall W x D x H	746W x 750D x 830H
Seat W x D x H	580W x 510D x 450H
Back W x D x H	580W x 510D x 410H
Weight Rating	Up to 150kg

### Finish :

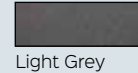

### Features :

- Durable powdercoated steel base
- Strong 12mm plywood skeleton
- High density foam



## CAPRI 3 SEATER - CAPRI3

### Dimensions :

Overall W x D x H	1950W x 750D x 830H
Seat W x D x H	1780W x 510D x 450H
Back W x D x H	1780W x 510D x 410H
Weight Rating	Up to 375kg

### Finish :

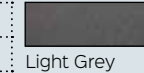

### Features :

- Durable powdercoated steel base
- Strong 12mm plywood skeleton
- High density foam





## VENUS OTTOMAN - VENUS ST

### Dimensions :

Width	1030mm
Depth	540mm
Height	410mm
Weight Rating	Up to 120kg

### Finish :

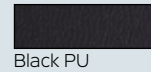

### Certifications :



### Features :

- PU Finish for Easy Maintenance
- Button Stitching Detail
- Stainless Steel Frame



## SPACE TUB - SPTUB1

### Dimensions :

Overall W x D x H	650 x 500 x 730mm
Seat W x D x H	540 x 430 x 446mm
Back Height	370mm
Weight Rating	Up to 120kg

### Finish :

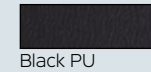

### Certifications :



### Features :

- Compact size
- Soft foam seat
- Black polyurethane upholstery



## SPACE EXECUTIVE TUB - SPEXEC TUB

### Dimensions :

Overall W x D x H	600 x 600 x 770mm
Seat W x D x H	480 x 470 x 480mm
Back Height	390mm
Weight Rating	Up to 120kg

### Finish :

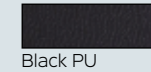

### Certifications :



### Features :

- Comfortable Larger Tub Seat
- Flared Arm Rest
- Stitching Detail on Back Rest



## VENUS SINGLE LOUNGE SEAT - VENUS1

### Dimensions :

Overall W x D x H	870 x 740 x 750mm
Seat W x D x H	630 x 500 x 420mm
Back W x D x H	630 x 110 x 400mm
Weight Rating	Up to 150kg

### Finish :

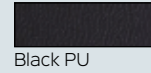

### Certifications :



### Features :

- Button detail finish
- Black polyurethane upholstery
- Stainless steel frame



## VENUS TWO SEATER LOUNGE - VENUS2

### Dimensions :

Overall W x D x H	1370 x 740 x 750mm
Seat W x D x H	1120 x 500 x 420mm
Back W x D x H	1120 x 110 x 400mm
Weight Rating	Up to 200kg

### Finish :

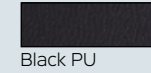

### Certifications :



### Features :

- Easy Maintenance
- Black polyurethane upholstery
- Stainless steel frame



## VENUS THREE SEATER LOUNGE - VENUS3

### Dimensions :

Overall W x D x H	2010 x 740 x 750mm
Seat W x D x H	1770 x 500 x 420mm
Back W x D x H	1170 x 110 x 400mm
Weight Rating	Up to 300kg

### Finish :

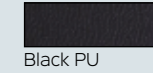

### Certifications :



### Features :

- Large three seater
- Black polyurethane upholstery
- Stainless steel frame



# RECEPTION & LOUNGE

## ASPEN TUB - ASPEN

### Dimensions :

Overall W x D x H	620 x 600 x 720mm
Seat W x D x H	460 x 440 x 470mm
Back Height	330mm
Weight Rating	Up to 120 kg

### Features :

- Comfortable tub chair
- High density moulded foam
- Natural Ash wooden base
- Steel skeleton in seat

### Finish :



Light Grey



## OPAL TUB - OPAL LG

### Dimensions :

Overall W x D x H	690 x 660 x 750mm
Seat W x D x H	430 x 400 x 410mm
Back Height	350mm
Weight Rating	Up to 120kg

### Features :

- Moulded foam seat and back
- Strong, powdercoated, steel underframe
- Full Fabric Upholstery
- Adjustable feet

### Finish :



Light Grey



## SPLASH CUBE SINGLE CHAIR - SPLASH CUBE

### Dimensions :

Overall W x D x H	655 x 570 x 725mm
Seat W x D x H	460 x 520 x 500mm
Back W x H	460 x 330mm
Weight Rating	Up to 120kg

### Features :

- Contemporary style
- Cube shaped chair
- Chrome sled base underframe

### Finish Options :

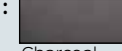

Charcoal



Red



## CLOVER TUB CHAIR - CLOVER CH

### Dimensions :

Overall W x D x H	680 x 550 x 795mm
Seat W x D x H	530 x 460 x 445mm
Back W x H	520 x 400mm
Weight Rating	Up to 130kg

### Features :

- Full fabric single lounge
- Stylish tapered back rest
- Angled cut arm rests

### Finish :

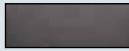

Charcoal



## ETERNITY ROUND COFFEE TABLE - ECT66

### Dimensions :

ECT600	600mm dia
ECT900	900mm dia
Height	450mm

### Top Finish :

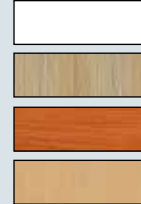

### Base Finish :

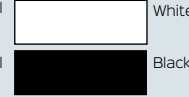

### Features :

- Powdercoat legs
- Set of 4 legs
- Adjustable feet
- Matches Eternity workstation range

### Certifications :



## ETERNITY SQUARE COFFEE TABLE - ECT99

### Dimensions :

Width	900mm
Depth	900mm
Height	450mm

### Top Finish :



### Base Finish :

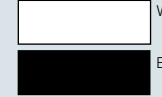

### Features :

- Powdercoat legs
- Set of 4 legs
- Adjustable feet
- Matches Eternity workstation range

### Certifications :





## ROUND COFFEE TABLE - CCT6

### Dimensions :

Top Diameter	600mm
Overall Height	450mm
Overall Height	450mm

### Top Finish :

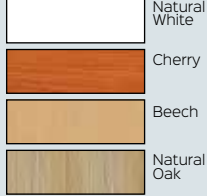

### Base Finish :

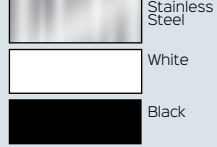

### Certifications :



### Features :

- Flat disc base
- Multiple colour choices
- Mix and match colours
- E0 Melamine board



## ETERNITY RECTANGULAR COFFEE TABLE - ECT126

### Dimensions :

Overall Width	1200mm
Overall Depth	600mm
Overall Height	450mm

### Top Finish :

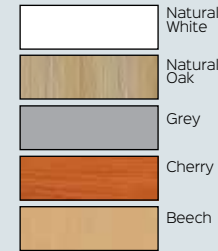

### Base Finish :



### Certifications :



### Features :

- Powdercoat Frame
- Double support rails
- E0 Melamine board
- Mix and Match top and frame colours



## BUDGET COFFEE TABLE - CT96

### Dimensions :

Table Top Width	900mm
Table Top Depth	600mm
Table Top Height	425mm

### Finish :

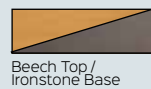

### Features :

- Robust design with magazine shelf
- 25mm Melamine Beech top
- Melamine Ironstone base
- E0 Melamine board

### Certifications :



## GLASS COFFEE TABLE

### Dimensions :

Table Top Width	• AGT66 - 600mm • AGT126 - 1200mm
Table Top Depth	600mm
Table Top Height	450mm

### Finish :

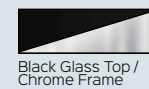

### Features :

- Black glass and Chrome frame
- Available in two sizes
- Square or rectangular shape

### Certifications :



## ETERNITY SIDE TABLE - EST34

### Dimensions :

Width	300mm
Depth	400mm
Height	600mm

### Top Finish :

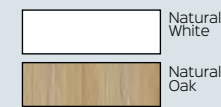

### Base Finish :

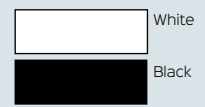

### Features :

- Powdercoat Frame
- E0 rated melamine top
- Slides under lounges

### Certifications :



# RAPID ETERNITY - SINGLE SIDED

## ETERNITY SINGLE SIDED WORKSTATIONS



D-ELS1P1575 NW / WS  
1 Person | 1500mm  
Natural White on White Satin



D-ELS1P1575 NO / BL  
1 Person | 1500mm  
Natural Oak on Black



D-ELS3P1575 NO / WS  
3 Person | 1500mm per user  
Natural Oak on White Satin

Create a space efficient workspace with Rapid Eternity, designed to maximise leg space, workstation strength and user communication.

### Features :

- Stylish Eternity angled leg
- Maximise office space
- Various sizes available
- 750mm Depth work top per user

### Single Sided Workstation Options :

- Choose the number of persons required for your run of desks
- Choose between 1200mm, 1500mm or 1800mm desks
- Choose between black or white powdercoated frames and legs
- Choose between natural oak or natural white scalloped top

### Dimensions :

\*Overall Measurements

Product	Users	Width	Depth	Height
D-ELS1P1275	1	1200mm	750mm	730mm
D-ELS1P1575	1	1500mm	750mm	730mm
D-ELS1P1875	1	1800mm	750mm	730mm
D-ELS2P1275	2	2400mm	750mm	730mm
D-ELS2P1575	2	3000mm	750mm	730mm
D-ELS2P1875	2	3600mm	750mm	730mm
D-ELS3P1275	3	3600mm	750mm	730mm
D-ELS3P1575	3	4500mm	750mm	730mm
D-ELS3P1875	3	5400mm	750mm	730mm

### Top Finishes :

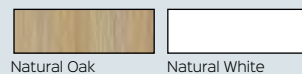

### Leg and Frame Finishes :



### Certifications :



## ETERNITY SINGLE SIDED WORKSTATIONS WITH SCREENS



D-ELSW1P1575 NW / BL  
1 Person | 1500mm  
Natural White on Black



D-ELSW1P1575 NO / WS  
1 Person | 1500mm  
Natural Oak on White Satin



D-ELSW2P1575 NO / BL  
2 Person | 1500mm per user  
Natural Oak on Black



## ETERNITY SINGLE SIDED WORKSTATIONS WITH SCREENS

### Features :

- Stylish Eternity angled leg
- Maximise office space
- Various sizes available
- 750mm Depth work top per user
- 730mm Desk height

### Single Sided Workstations with Screens Options :

- Choose the number of persons required for your run of desks
- Choose between 1200mm, 1500mm or 1800mm desks
- Choose between black or white powdercoated frames and legs
- Choose between natural oak or natural white scalloped top
- Comes with 495mm high x 30mm thick fabric screens
- Choose between black fabric screen with white frame or grey fabric screen with black frame

### Dimensions :

\*Overall Measurements

Product	Users	Width	Depth	Height (Incl. screens)
D-ELSW1P1275	1	1200mm	780mm	1200mm
D-ELSW1P1575	1	1500mm	780mm	1200mm
D-ELSW1P1875	1	1800mm	780mm	1200mm
D-ELSW2P1275	2	2400mm	780mm	1200mm
D-ELSW2P1575	2	3000mm	780mm	1200mm
D-ELSW2P1875	2	3600mm	780mm	1200mm
D-ELSW3P1275	3	3600mm	780mm	1200mm
D-ELSW3P1575	3	4500mm	780mm	1200mm
D-ELSW3P1875	3	5400mm	780mm	1200mm

### Top Finishes :

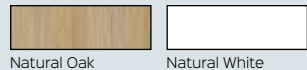

Natural Oak      Natural White

### Leg and Frame Finishes :



Black Powdercoat      White Powdercoat

### Screen Finishes :



Grey Fabric / Black Frame      Black Fabric / White Frame

**Rapidline Upholstery**  
See Page 69



### Certifications :



## ETERNITY SINGLE SIDED CORNER WORKSTATIONS



**D-ELCWS1P1818 NW / BL**  
1 Person | 1800 x 1800mm  
Natural White on Black



**D-ELCWS1P1818 NO / WS**  
1 Person | 1800 x 1800mm  
Natural Oak on White Satin



**D-ELCWS1P1818 NO / BL**  
1 Person | 1800 x 1800mm  
Natural Oak on Black

### Features :

- Maximise office space
- Various sizes available
- 750mm Depth work top per user
- Create a full matching suite with your Eternity desks

### Single Corner Workstations Options :

- Choose between 1500 x 1500mm, 1800 x 1500mm or 1800 x 1800mm individual corner desks
- Choose black or white powdercoated frames and end legs
- Choose between natural oak or natural white top finishes
- All corner tops come with cable access hole

### Dimensions :

\*Overall Measurements

Product	Users	Width	Depth	Height
D-ELCWS1P1515	1	1500 x 1500mm	750mm	730mm
D-ELCWS1P1815	1	1800 x 1500mm	750mm	730mm
D-ELCWS1P1818	1	1800 x 1800mm	750mm	730mm

### Top Finishes :

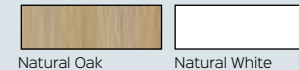

Natural Oak

Natural White

### Certifications :



### Leg and Frame Finishes :



Black Powdercoat

White Powdercoat

The Rapid Eternity Corner Workstation is a modular system that can suit any number of users required, with or without screens and accessories.

Matching round table and high bar table available.

Contact us today for more information.



# RAPID ETERNITY - DOUBLE SIDED

## ETERNITY DOUBLE SIDED WORKSTATIONS



**D-ELD2P1575 NO / BL**  
2 Person | 1500mm  
Natural Oak on Black

### Features :

- Stylish Eternity angled leg
- Maximise office space
- Various sizes available
- 750mm Depth work top per user

### Double Sided Workstations Options :

- Choose the number of persons required for your run of desks
- Choose 1200mm, 1500mm or 1800mm desks
- Choose black or white powdercoated frames and legs
- Choose natural oak or natural white scalloped top
- Choose to have optional infill rail to fill centre 30mm gap - see Infinity accessories page 22.

### Dimensions :

\*Overall Measurements

Product	Users	Width	Depth	Height
D-ELD2P1275	2	1200mm	1530mm	730mm
D-ELD2P1575	2	1500mm	1530mm	730mm
D-ELD2P1875	2	1800mm	1530mm	730mm
D-ELD4P1275	4	2400mm	1530mm	730mm
D-ELD4P1575	4	3000mm	1530mm	730mm
D-ELD4P1875	4	3600mm	1530mm	730mm
D-ELD6P1275	6	3600mm	1530mm	730mm
D-ELD6P1575	6	4500mm	1530mm	730mm
D-ELD6P1875	6	5400mm	1530mm	730mm



**D-ELD4P1575 NW / BL**  
4 Person | 1500mm  
Natural White on Black



**D-ELD6P1875 NO / WS**  
6 Person | 1800mm per user  
Natural Oak on White Satin

### Top Finishes :

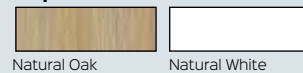

### Leg and Frame Finishes :



### Certifications :

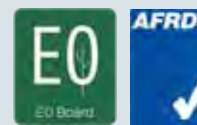

The Rapid Eternity is a modular system that can suit any number of users required, contact us today for more information.



## ETERNITY DOUBLE SIDED WORKSTATIONS WITH SCREENS



**D-ELDWS2P1575 NO / WS**  
2 Person | 1500mm  
Natural Oak on White Satin



**D-ELDWS4P1575 NW / WS**  
4 Person | 1500mm  
Natural White on White Satin



**D-ELDWS6P1875 NO / BL**  
6 Person | 1800mm per user  
Natural Oak on Black



## ETERNITY DOUBLE SIDED WORKSTATIONS WITH SCREENS

### Features :

- Stylish Eternity angled leg
- Maximise office space
- Various sizes available
- 750mm Depth work top per user
- 730mm Desk height

### Double Sided Workstations with Screens Options :

- Choose the number of persons required for your run of desks
- Choose between 1200mm, 1500mm or 1800mm desks
- Choose between black or white powdercoated frames and legs
- Choose between natural oak or natural white scalloped top
- Comes with 500mm high x 30mm thick fabric screens
- Choose between black fabric screen with white frame or grey fabric screen with black frame

### Dimensions :

\*Overall Measurements

Product	Users	Width	Depth	Height (Incl. screens)
D-ELDWS2P1275	2	1200mm	1530mm	1200mm
D-ELDWS2P1575	2	1500mm	1530mm	1200mm
D-ELDWS2P1875	2	1800mm	1530mm	1200mm
D-ELDWS4P1275	4	2400mm	1530mm	1200mm
D-ELDWS4P1575	4	3000mm	1530mm	1200mm
D-ELDWS4P1875	4	3600mm	1530mm	1200mm
D-ELDWS6P1275	6	3600mm	1530mm	1200mm
D-ELDWS6P1575	6	4500mm	1530mm	1200mm
D-ELDWS6P1875	6	5400mm	1530mm	1200mm

### Top Finishes :

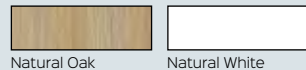

Natural Oak

Natural White

### Leg and Frame Finishes :



Black Powdercoat

White Powdercoat

### Screen Finishes :



Grey Fabric /  
Black Frame

Black Fabric /  
White Frame



See Page 69



### Certifications :



## ETERNITY 4-PERSON POD OF CORNER WORKSTATIONS WITH SCREENS

### D-ELCWS4P1818 NO / WS

4 Person | 1800 x 1800mm per user | Natural Oak on White Satin



### D-ELCWS4P1818 NW / BL

4 Person | 1800 x 1800mm per user | Natural White on Black



### D-ELCWS4P1818 NO / BL

4 Person | 1800 x 1800mm per user | Natural Oak on Black



### Features :

- Maximise office space
- Encourage team work
- 750mm Depth work top per user
- 3 workstation sizes available

### 4-Pod Corner Workstations with Screen Options :

- Choose between 1500 x 1500mm, 1800 x 1500mm or 1800 x 1800mm individual corner desk tops
- Choose between black or white powdercoated frames and legs
- Choose between natural oak or natural white scalloped top
- Comes with 500mm high x 30mm thick fabric screens
- Choose between black fabric screen with white frame or grey fabric screen with black frame

### Dimensions :

\*Overall Measurements

Product	Users	Width	Depth	Height
D-ELCWS4P1515	4	3030 x 3030mm	1500mm	1200mm
D-ELCWS4P1815	4	3630 x 3030mm	1500mm	1200mm
D-ELCWS4P1818	4	3630 x 3630mm	1500mm	1200mm

### Top Finishes :

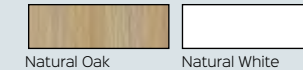

Natural Oak

Natural White

### Leg and Frame Finishes :



Black Powdercoat

White Powdercoat

### Screen Finishes :



Grey Fabric /  
Black Frame

Black Fabric /  
White Frame

### Certifications :

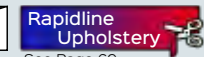

See Page 69



# DELUXE RAPID INFINITY

## DELUXE RAPID INFINITY SINGLE SIDED WORKSTATIONS

**D-IPLS1P1875 NO / WS**  
Natural Oak, White Satin  
Profile Leg  
1 Person



Create a space efficient workspace with Deluxe Rapid Infinity, designed to maximise leg space, workstation strength and user communication.



### Single Sided Workstation Options

- Choose from the Profile or Loop end leg styles
- Choose between 1200mm, 1500mm or 1800mm individual desk top widths x 750mm depth
- Choose the number of persons required for your run of desks
- Choose between black or white powdercoated frames and legs
- Choose between natural oak or natural white scalloped top

### Top Finishes :

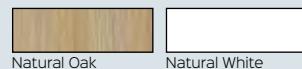

### Leg and Frame Finishes :



### Profile Leg

\*Overall Measurements

Product	Users	Width	Depth	Height
D-IPLS1P1275	1	1200mm	750mm	730mm
D-IPLS1P1575	1	1500mm	750mm	730mm
D-IPLS1P1875	1	1800mm	750mm	730mm
D-IPLS2P1275	2	2400mm	750mm	730mm
D-IPLS2P1575	2	3000mm	750mm	730mm
D-IPLS2P1875	2	3600mm	750mm	730mm
D-IPLS3P1275	3	3600mm	750mm	730mm
D-IPLS3P1575	3	4500mm	750mm	730mm
D-IPLS3P1875	3	5400mm	750mm	730mm

### Loop Leg

D-IPLS1P1275	1	1200mm	750mm	730mm
D-IPLS1P1575	1	1500mm	750mm	730mm
D-IPLS1P1875	1	1800mm	750mm	730mm
D-IPLS2P1275	2	2400mm	750mm	730mm
D-IPLS2P1575	2	3000mm	750mm	730mm
D-IPLS2P1875	2	3600mm	750mm	730mm
D-IPLS3P1275	3	3600mm	750mm	730mm
D-IPLS3P1575	3	4500mm	750mm	730mm
D-IPLS3P1875	3	5400mm	750mm	730mm

**D-IILS2P1875 NW / BL**  
Natural White, Black  
Loop Leg  
2 Person



**D-IPLS3P1875 NO / BL**  
Natural Oak, Black  
Profile Leg  
3 Person



## SINGLE SIDED WORKSTATIONS WITH SCREENS

**D-IILSWS1P1875 NO / BL**  
Natural Oak, Black  
Loop Leg  
1 Person



**D-IPLSWS2P1875 NO / WS**  
Natural Oak, White Satin  
Profile Leg  
2 Person



**D-IILSWS3P1875 NW / BL**  
Natural White, Black  
Loop Leg  
3 Person





## SINGLE SIDED WORKSTATIONS WITH SCREENS

### Single Sided Workstations with Screens Options

- Choose from the Profile or Loop end leg styles
- Choose between 1200mm, 1500mm or 1800mm individual desk top widths x 750mm depth
- Choose the number of persons required for your run of desks
- Choose between black or white powdercoated frames and legs
- Choose between natural oak or natural white scalloped top
- Choose between black fabric screen with white frame or grey fabric screen with black frame
- Comes with 500mm high x 30mm thick fabric screen



### Top Finishes :



Natural Oak



Natural White

### Leg and Frame Finishes :

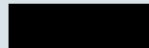

Black Powdercoat



White Powdercoat

### Screen Finishes :



Grey Fabric /  
Black Frame



Black Fabric /  
White Frame



See Page 69



### Profile Leg

\*Overall Measurements

Product	Users	Width	Depth	Height
D-IPLSWS1P1275	1	1200mm	780mm	1200mm
D-IPLSWS1P1575	1	1500mm	780mm	1200mm
D-IPLSWS1P1875	1	1800mm	780mm	1200mm
D-IPLSWS2P1275	2	2400mm	780mm	1200mm
D-IPLSWS2P1575	2	3000mm	780mm	1200mm
D-IPLSWS2P1875	2	3600mm	780mm	1200mm
D-IPLSWS3P1275	3	3600mm	780mm	1200mm
D-IPLSWS3P1575	3	4500mm	780mm	1200mm
D-IPLSWS3P1875	3	5400mm	780mm	1200mm

### Loop Leg

D-ILLSWS1P1275	1	1200mm	780mm	1200mm
D-ILLSWS1P1575	1	1500mm	780mm	1200mm
D-ILLSWS1P1875	1	1800mm	780mm	1200mm
D-ILLSWS2P1275	2	2400mm	780mm	1200mm
D-ILLSWS2P1575	2	3000mm	780mm	1200mm
D-ILLSWS2P1875	2	3600mm	780mm	1200mm
D-ILLSWS3P1275	3	3600mm	780mm	1200mm
D-ILLSWS3P1575	3	4500mm	780mm	1200mm
D-ILLSWS3P1875	3	5400mm	780mm	1200mm

## DELUXE RAPID INFINITY DOUBLE SIDED WORKSTATIONS

### D-IPLD2P1875 NO / BL

Natural Oak, Black

Profile Leg

2 Person



### D-ILLD4P1875 NW / BL

Natural White, Black

Loop Leg

4 Person



### D-IPLD6P1875 NO / WS

Natural Oak, White Satin

Profile Leg

6 Person



Deluxe Rapid Infinity is a modular system that can suit any number of users required, contact us for more information.



### Double Sided Workstation Options

- Choose the number of persons required for your double sided run of desks
- Choose from the Profile or Loop end leg styles
- Choose between 1200mm, 1500mm or 1800mm individual desk top widths x 750mm depth
- Choose between black or white powdercoated frames and legs
- Choose between natural oak or natural white scalloped top
- Choose to have optional infill rail to fill centre gap - see Infinity accessories page. Or use as cable access gap



### Top Finishes :

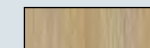

Natural Oak



Natural White

### Leg and Frame Finishes :

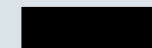

Black Powdercoat



White Powdercoat

### Profile Leg

\*Overall Measurements

Product	Users	Width	Depth	Height
D-IPLD2P1275	2	1200mm	1530mm	730mm
D-IPLD2P1575	2	1500mm	1530mm	730mm
D-IPLD2P1875	2	1800mm	1530mm	730mm
D-IPLD4P1275	4	2400mm	1530mm	730mm
D-IPLD4P1575	4	3000mm	1530mm	730mm
D-IPLD4P1875	4	3600mm	1530mm	730mm
D-IPLD6P1275	6	3600mm	1530mm	730mm
D-IPLD6P1575	6	4500mm	1530mm	730mm
D-IPLD6P1875	6	5400mm	1530mm	730mm

### Loop Leg

D-ILLD2P1275	2	1200mm	1530mm	730mm
D-ILLD2P1575	2	1500mm	1530mm	730mm
D-ILLD2P1875	2	1800mm	1530mm	730mm
D-ILLD4P1275	4	2400mm	1530mm	730mm
D-ILLD4P1575	4	3000mm	1530mm	730mm
D-ILLD4P1875	4	3600mm	1530mm	730mm
D-ILLD6P1275	6	3600mm	1530mm	730mm
D-ILLD6P1575	6	4500mm	1530mm	730mm
D-ILLD6P1875	6	5400mm	1530mm	730mm

# DELUXE RAPID INFINITY

## DELUXE RAPID INFINITY DOUBLE SIDED WORKSTATIONS WITH SCREENS

**D-IPLDWS2P1875 NO / WS**  
Natural Oak, White Satin  
Profile Leg  
2 Person



**D-ILLDWS4P1875 NW / WS**  
Natural White, White Satin  
Loop Leg  
4 Person



**D-IPLDWS6P1875 NO / BL**  
Natural Oak, Black  
Profile Leg  
6 Person



### Double Sided Workstations with Screen Options

- Choose from the Profile or Loop end leg styles
- Choose between 1200mm, 1500mm or 1800mm individual desk top widths x 750mm depth
- Choose the number of persons required for your run of desks
- Choose between black or white powdercoated frames and legs
- Choose between natural oak or natural white scalloped top
- Choose between black fabric screen with white frame or grey fabric screen with black frame
- Comes with 500mm high x 30mm thick fabric screen



### Top Finishes

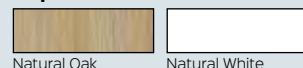

Natural Oak      Natural White

### Leg and Frame Finishes



Black Powdercoat      White Powdercoat

### Screen Finishes :



Grey Fabric / Black Frame      Black Fabric / White Frame



See Page 69



### Profile Leg

\*Overall Measurements

Product	Users	Width	Depth	Height
D-IPLDWS2P1275	2	1200mm	1530mm	1200mm
D-IPLDWS2P1575	2	1500mm	1530mm	1200mm
D-IPLDWS2P1875	2	1800mm	1530mm	1200mm
D-IPLDWS4P1275	4	2400mm	1530mm	1200mm
D-IPLDWS4P1575	4	3000mm	1530mm	1200mm
D-IPLDWS4P1875	4	3600mm	1530mm	1200mm
D-IPLDWS6P1275	6	3600mm	1530mm	1200mm
D-IPLDWS6P1575	6	4500mm	1530mm	1200mm
D-IPLDWS6P1875	6	5400mm	1530mm	1200mm

### Loop Leg

D-ILLDWS2P1275	2	1200mm	1530mm	1200mm
D-ILLDWS2P1575	2	1500mm	1530mm	1200mm
D-ILLDWS2P1875	2	1800mm	1530mm	1200mm
D-ILLDWS4P1275	4	2400mm	1530mm	1200mm
D-ILLDWS4P1575	4	3000mm	1530mm	1200mm
D-ILLDWS4P1875	4	3600mm	1530mm	1200mm
D-ILLDWS6P1275	6	3600mm	1530mm	1200mm
D-ILLDWS6P1575	6	4500mm	1530mm	1200mm
D-ILLDWS6P1875	6	5400mm	1530mm	1200mm

## SINGLE CORNER WORKSTATION

**D-ILLCWS1P1815 NW / BL**  
1800mm x 1500mm  
Natural White, Black  
Loop Leg  
1 Person



**D-IPLCWS1P1818 NO / WS**  
1800mm x 1800mm  
Natural Oak, White  
Profile Leg  
1 Person



**D-ILLCWS1P1818 NO / BL**  
1800mm x 1800mm  
Natural Oak, Black  
Loop Leg  
1 Person



## SINGLE CORNER WORKSTATION

### Single Corner Workstation Options

- Choose from the Profile or Loop end leg styles
- Choose between 1500 x 1500mm, 1800 x 1500mm or 1800 x 1800mm individual corner desk top widths x 750mm depth
- Choose between black or white powdercoated frames and end legs
- Choose between natural oak or natural white top finishes
- All corner tops come with cable access hole

#### Top Finishes :

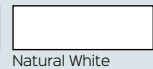
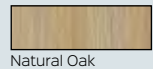

#### Leg and Frame Finishes :

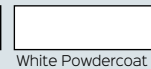
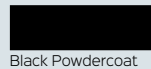

#### Profile Leg

\*Overall Measurements

Product Code	Users	Width	Depth	Height
D-IPLCWS1P1515	1	1500 x 1500mm	750mm	730mm
D-IPLCWS1P1815	1	1800 x 1500mm	750mm	730mm
D-IPLCWS1P1818	1	1800 x 1800mm	750mm	730mm

#### Loop Leg

Product Code	Users	Width	Depth	Height
D-ILLCWS1P1515	1	1500 x 1500mm	750mm	730mm
D-ILLCWS1P1815	1	1800 x 1500mm	750mm	730mm
D-ILLCWS1P1818	1	1800 x 1800mm	750mm	730mm

The Deluxe Rapid Infinity Corner Workstation is a modular system that can suit any number of users required, with or without screens and accessories.

Contact us today for more information.



## 4-PERSON POD OF CORNER WORKSTATIONS WITH SCREENS

### D-ILLCWS4PWS1815 NO / WS

Natural Oak, White Satin

Loop Leg

4 Person



### D-IPLCWS4PWS1818 NW / BL

Natural White, Black

Profile Leg

4 Person



### D-ILLCWS4PWS1818 NO / BL

Natural Oak, Black

Loop Leg

4 Person



### 4-Person Corner Workstation Pod With Screen Options

- Choose from the Profile or Loop end leg
- Choose from 1500 x 1500mm, 1800 x 1500mm or 1800 x 1800mm individual corner desk top widths x **750mm depth**
- Choose between natural oak or natural white top finishes
- Choose between black or white powdercoated frames and legs
- Choose between black fabric screen with white frame or grey fabric screen with black frame.
- Fabric screen is 500mm high x 30mm thick

#### Top Finishes

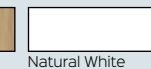
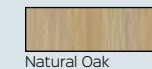

#### Leg and Frame Finishes

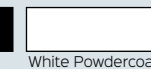
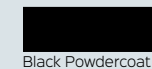

#### Screen Finishes



See Page 69



#### Profile Leg

\*Overall Measurements

Product Code	Users	Width	Depth	Height
D-IPLCWS4P1515	4	3000 x 3000mm	1500mm	1200mm
D-IPLCWS4P1815	4	3600 x 3000mm	1500mm	1200mm
D-IPLCWS4P1818	4	3600 x 3600mm	1500mm	1200mm

#### Loop Leg

D-ILLCWS4P1515	4	3000 x 3000mm	1500mm	1200mm
D-ILLCWS4P1815	4	3600 x 3000mm	1500mm	1200mm
D-ILLCWS4P1818	4	3600 x 3600mm	1500mm	1200mm

### Why Choose Deluxe Infinity?

- Black or white leg options
- 750mm deep work top for more space
- Natural white or natural oak top finish options
- Scalloped cable access for straight work tops
- Grey screen available with black frame





# DELUXE INFINITY & ETERNITY DESK AND RETURN

## ETERNITY DESK AND RETURN

### Dimensions :

Width	1800 x 1800mm Overall
Depth	750 at Desk, 600 at Return
Height	730mm

### Certifications :



### Features :

- 2-Piece top with 90 degree corner
- Double support rails
- Adjustable levelling feet
- 25mm Thick E0 rated melamine board
- Scalloped edge for cable access on one side

### Top Options :



### Base Options :

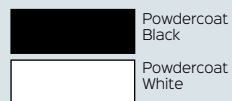

## LOOP LEG DESK AND RETURN

### Dimensions :

Width	1800 x 1800mm Overall
Depth	750 at Desk, 600 at Return
Height	730mm

### Certifications :



### Features :

- 2-Piece top with 90 degree corner
- Double support rails
- Adjustable levelling feet
- 25mm Thick E0 rated melamine board
- Scalloped edge for cable access on one side

### Top Options :

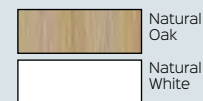

### Base Options :

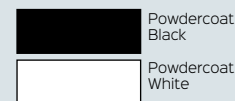

## PROFILE LEG DESK AND RETURN

### Dimensions :

Width	1800 x 1800mm Overall
Depth	750 at Desk, 600 at Return
Height	730mm

### Certifications :



### Features :

- 2-Piece top with 90 degree corner
- Double support rails
- Adjustable levelling feet
- 25mm Thick E0 rated melamine board
- Scalloped edge for cable access on one side

### Top Options :



### Base Options :

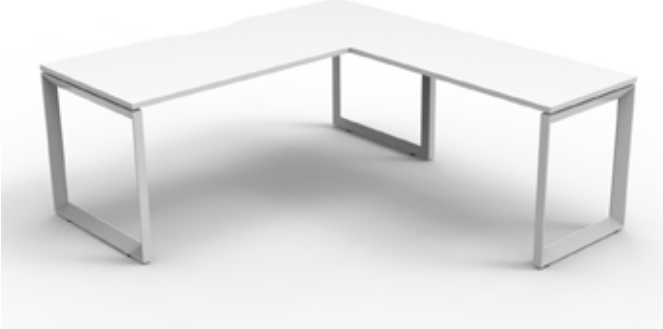
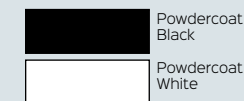

## INFINITY SWING DOOR CUPBOARDS

### Dimensions :

Options	<ul style="list-style-type: none"> <li>• IFSD96 - 2 Door - 900 x 600mm</li> <li>• IFSD1245 - 3 Door - 1200 x 450mm</li> <li>• IFSD1545 - 3 Door - 1500 x 450mm</li> <li>• IFSD1845 - 4 Door - 1800 x 450mm</li> </ul>
Height	730mm

### Finish Options :



### Features :

- Lockable - 2 keys supplied
- Shark nose feature on tops of doors
- Black edging feature
- Adjustable levelling feet & Soft close hinges
- 18mm Thick E0 rated melamine board

### Certifications :



## INFINITY BOOKCASES

### Dimensions :

Options	<ul style="list-style-type: none"> <li>• IFBK12 - 1200mm Height</li> <li>• IFBK18 - 1800mm Height</li> </ul>
Width	900mm
Depth	315mm

### Finish Options :

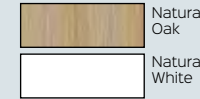

### Features :

- Adjustable shelves
- Black edging feature
- Aluminium tapered legs
- 25mm Thick Shelves, 18mm Sides
- E0 rated melamine board

### Certifications :



## ETERNITY MEETING TABLE

### Dimensions :

Round	<ul style="list-style-type: none"> <li>• D-ERT9 - 900mm Dia.</li> <li>• D-ERT12 - 1200mm Dia.</li> </ul>
Square	• D-ERT990 - 900W x 900D
Height	730mm

### Top Finish :



### Base Finish :



### Features :

- Powdercoat base
- 25mm thick E0 Melamine top
- 2mm gauge steel construction
- Matches Eternity range

### Certifications :



## CLAMP MOUNT SHELF - CMSHELF600

### Dimensions :

Width	600mm
Depth	270mm
Height	475mm

### Finish Options :

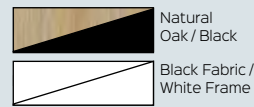

### Features :

- 25mm thick E0 rated enviroboard
- Comes with 4 x wire dividers
- Convenient shelf above desk top
- Clamps onto desk top

### Certifications :



## INFINITY DESK MOUNTED SHELF - DMSHELF

### Dimensions :

Width	600mm
Depth	300mm
Overall Height	450mm
Desk Top to Shelf Height	208mm

### Finish Options :

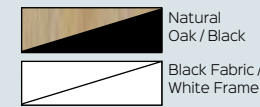

### Features :

- 25mm thick E0 rated enviroboard
- Comes with 4 x wire dividers

### Certifications :



## INFINITY SCREEN HUNG SHELF - ISHELF600

### Dimensions :

Width	600mm
Depth	270mm
Height	250mm

### Finish Options :

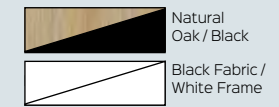

### Features :

- 18mm thick E0 rated enviroboard
- Powdercoated steel shelf brackets
- Available in 2 finishes
- Hangs from infinity centre screens

### Certifications :



# DELUXE INFINITY & ETERNITY ACCESSORIES

## FIXED 2400mm LENGTH SUPPORT RAIL - FR2400

### Dimensions :

Width	2326mm
Depth	25mm
Height	40mm

### Finish Options :

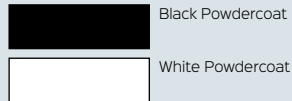

### Features :

- Suits 2400mm Wide table tops with Profile legs
- Creates a 2590mm Wide table when used with Eternity legs
- Double support rails to strengthen top
- Comes as a set of 2



## DOUBLE TELESCOPIC SUPPORT RAILS

### Dimensions :

Options	ITR1012 - 1200mm Desks ITR1518 - 1500 & 1800mm Desks ITR7011 - Corner Workstations
Depth	30mm
Height	30mm

### Finish Options :

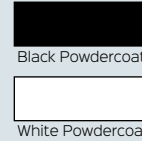

### Features :

- Used to strengthen desk tops
- Telescopic rails for 1800mm and under



## EXTRA LONG TELESCOPIC SUPPORT RAILS - ITR1812

### Dimensions :

Width	1726 - 2106mm
Depth	30mm
Height	30mm

### Finish Options :

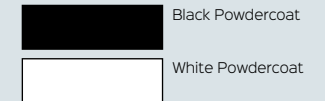

### Features :

- Used to create desks 1800mm to 2100mm wide
- Double support rails to strengthen top
- Comes as a set of 2



## INFINITY INFILL PANEL

### Dimensions :

Width	D-IF12 - 1200mm
Options	D-IF15 - 1500mm D-IF18 - 1800mm
Depth	30mm
Height	30mm

### Finish Options :

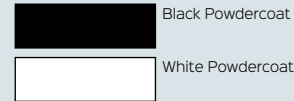

### Features :

- Fills 30mm gap between double sided back to back Deluxe and Infinity workstation ranges

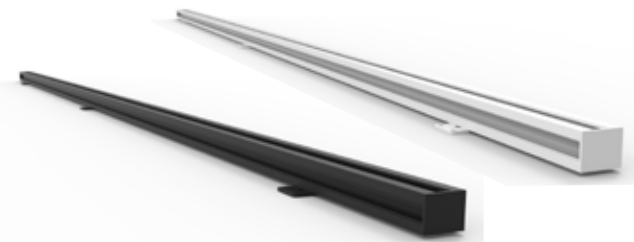

## 600mm LEGS

### Specifications :

PRL600	Profile Leg
LRL600	Loop Leg
ERL600	Eternity Leg

### Finish Options :

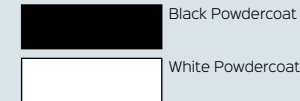

### Features :

- Use as a return leg for desk & returns
- Use where recessed legs are required



## RAIL CLAMP - IRC

### Dimensions :

Width	129mm
Depth	32mm
Height	40mm

### Finish Options :



### Features :

- Used for corner workstations or desks with returns
- Clamps to double support rails
- Comes in set of 2





# DELUXE INFINITY & ETERNITY DESK MOUNTED SCREEN

## SHS DESK MOUNTED SCREEN

### Dimensions :

Width	SHS754 - 750mm
Options	SHS1204 - 1200mm SHS1504 - 1500mm SHS1804 - 1800mm
Height	495mm
Thickness	30mm

### Finish Options :

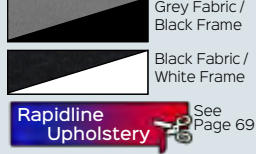

Rapidline Upholstery See Page 69

NEW



### Features :

- Pinnable fabric screen
- Upholster in our range of House Fabrics
- \*Requires additional Fixings. Ask us before you order\*



## DESK MOUNTED SCREEN JOINING POLES

### Specifications :

Height	495mm
Width	30mm
Thickness	30mm

### Finish Options :

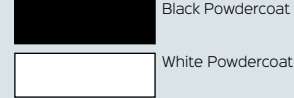

### Features :

- Used for joining and stabilising return screens
- Used where screens join at 90 Degrees

NEW



SHSJP495

## DESK MOUNTED SCREEN CLAMP

### Specifications :

Height	66mm
Width	80mm
Depth	44mm

### Finish Options :

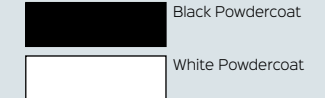

### Features :

- Use when attaching a screen to a desk where drill holes are not desired
- Screens mounted using this clamp will sit above desk tops
- Better suited to desks with cable entry holes due to the above
- Suits desk thickness up to 26mm
- Comes as set of 2

NEW



SHS-CL

## SCREEN FIXING PLATE FOR SINGLE DESKS

### Specifications :

Height	40mm
Width	122mm
Depth	100mm

### Finish Options :

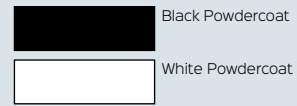

### Features :

- Use to fix screens to desks, drill holes required on bottom of desk
- Screens mounted using this clamp will sit flush with desk top
- Better suited to tops with scalloped edge
- Suits desk thickness up to 26mm
- Comes as set of 2

NEW



SHS-FS

## SCREEN FIXING PLATE FOR BACK TO BACK DESKS

### Specifications :

Height	40mm
Width	100mm
Depth	70mm

### Finish Options :

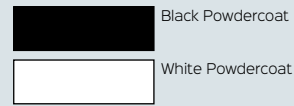

### Features :

- Use to fix screens to back to back desk configurations
- Clamp for SHS Desk Mounted Screens
- Suits desk thickness up to 26mm
- Comes as set of 2

NEW

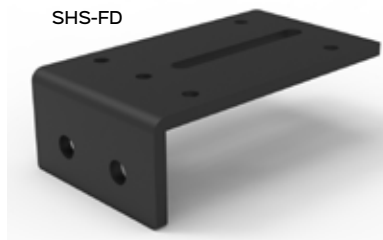

SHS-FD

## SCREEN FIXING PLATE FOR RETURN SCREENS

### Specifications :

SHS-LB	Use for desk mounted screens on single desks
SHS-TB	Use for desk mounted screens between 2 desks

### Features :

- For use with 750mm wide return screens
- 120mm W x 50mm D x 5mm H
- Single Screw Plate Only, not sold in pairs

### Finish Options :

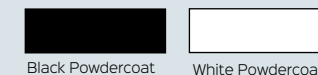

NEW



SHS-LB

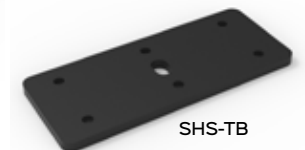

SHS-TB

# SHUSH30+ FULL HEIGHT

## SHUSH30 SCREEN HUNG WORKSTATIONS



## SIDE TO SIDE



## BACK TO BACK



The SHUSH30+ screen range features a 30mm slimline screen with a square profile, powder coat frame and a full fabric pinnable surface with adjustable levelling feet.

The two heights allow for either full communication or some privacy between users.

Comes in 2 standard colour options or can be upholstered in our Rapidline Upholstery Fabrics range.

\*Lead times and additional charges apply

The SHUSH30+ is a screen system that can create endless configurations.

Create runs of any length, use the 2 different screen heights to create privacy or encourage teamwork. Upholster in a range of Rapidline fabrics and create desks of 3 different sizes.

### Top Finishes :

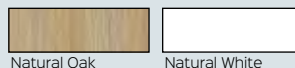

### Screen Finishes :



Rapidline Upholstery  See Page 69

### Certifications :



## Components :

Top Options	Natural Oak or Natural White with scalloped edge DST1275 - 1200mm W x 750mm D DST1575 - 1500mm W x 750mm D DST1875 - 1800mm W x 750mm D
Screen Options	Black frame with Grey Fabric or White frame with Grey fabric SHS712 - 750mm W x 1200mm H x 30mm T SHS1212 - 1200mm W x 1200mm H x 30mm T SHS1512 - 1500mm W x 1200mm H x 30mm T SHS1812 - 1800mm W x 1200mm H x 30mm T SHS715 - 750mm W x 1500mm H x 30mm T SHS1215 - 1200mm W x 1500mm H x 30mm T SHS1515 - 1500mm W x 1500mm H x 30mm T SHS1815 - 1800mm W x 1500mm H x 30mm T
Joining Pole	White or Black SHSJP1200 - Joining Pole for 1200mm Height SHSJP1500 - Joining Pole for 1500mm Height
Joining Brackets	Silver SCDESK BRACKET - Bracket to fasten workstation top to screen Comes as a set of 2

SHUSH30 CUBICLE

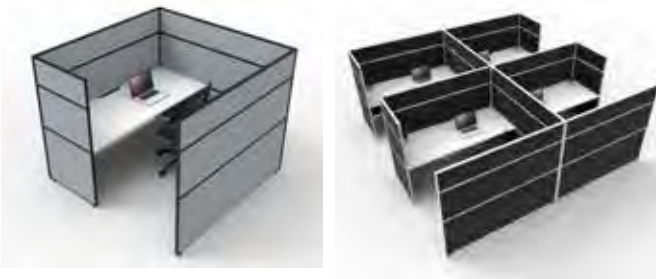

Create freestanding cubicles without constructing permanent walls.

Use taller screens to create private personal pods without the construction of walls.

Join pods to create as many cubicles as you require for your office set up.

SHUSH30 CORNER 1-2 person



Corner desks for more work space per user. Create a free standing self contained temporary cubicle that can be deconstructed and moved.

**Components :**

Corner	Natural Oak or Natural White with cable entry hole
Top	T1515-75 - 1500mm x 1500mm, 750mm Top Depth
Size	T1812-75 - 1800mm x 1200mm, 750mm Top Depth
Options	T1815-75 - 1800mm x 1500mm, 750mm Top Depth T1818-75 - 1800mm x 1800mm, 750mm Top Depth

SHUSH30 CORNER 4+



Create large team pods.

Use completely screen hung tops or use with Profile, Loop, Eternity, Span or DC-60 end legs.

Use ceiling to workstation power poles and umbilicals to take power and data to the workstations neatly and safely.



# SHUSH30+ FULL HEIGHT

## LEG OPTIONS

Mix and Match with Profile, Loop, Eternity, Span or DC-60 end legs with middle dividing screens.

Leg Options : Profile Leg - in Black or White  
 Loop Leg - in Black or White  
 Eternity Leg - in Black or White  
 DC60 - Round leg in Chrome, Black or White  
 SPLEG - Span leg in Silver, Black or White

\* Additional LRB18 Leg Blocks required for Eternity, Loop and Profile legs.  
 Available in Black or White powdercoat

All options available in :

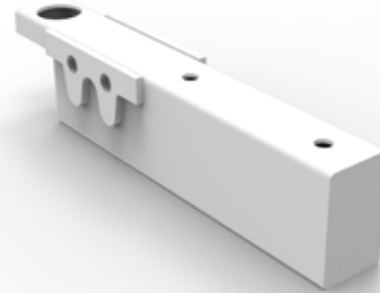

\*Pictured : LRB18 - Leg block for Eternity, Loop and Profile legs, comes in a set of 2

## FREE STANDING FEET - SHSFOOT

### Specifications :

Height	125mm
Width	505mm
Depth	66mm

### Finish Options :

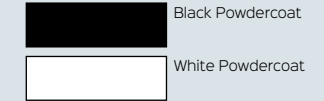

### Features :

- Used to convert screens in to free-standing screens
- Attaches to side of screen extrusion for a clean finish
- Powdercoat finish
- Comes as a set of 2



\*Pictured with Black SPLEG end legs



Also Available in Silver



\*Pictured with Black Eternity end legs



\*Pictured with White DC-60 end legs



Also Available in Chrome



\*Pictured with White Loop end legs





\*Pictured with White Free Standing Feet

## SHS-HAB BRACKETS

### Specifications :

Height	70mm
Width	138mm
Depth	72mm

### Finish Options :

	Black Powdercoat
	White Powdercoat

### Features :

- Recommended for use with 600mm deep Infinity and Eternity legs
- Used to fit a 900mm H SHUSH30+ screen to a fixed height desk
- Can be fixed at any height on a desk
- Functions as a screen and a modesty panel
- Brackets for screen only. \*Does not include screens, clamps or fixings\*
- 900mm Height screens also used on Boost+ with additional fixing arms. See Boost+ Range for more information.
- Comes as a set of 2 - 1 x Right, 1 x Left

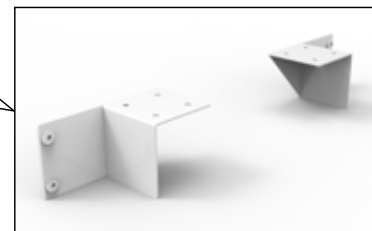
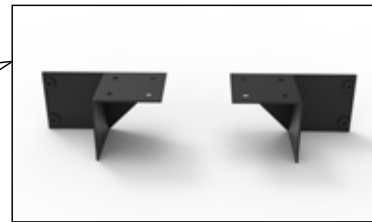
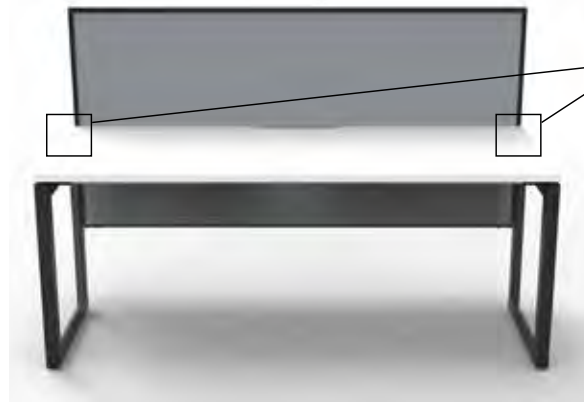

## B2-SLIBR BRACKETS

### Specifications :

Height	50mm
Width	25mm
Depth	8mm

### Finish Options :

	Black Powdercoat
	White Powdercoat

### Features :

- Use for 1200mm and 1500mm full height SHUSH30+ screens, with height adjustable workstations such as BOOST+
- Holds the screen sturdy when adjusting height on workstations
- Brackets for screen only. \*Does not include screens, clamps or fixings
- Includes Nylon brackets. Comes as a set of 2; 1 x Right, 1 x Left

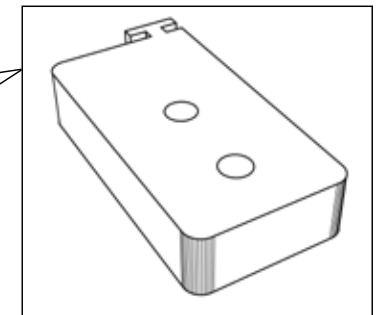

\*Pictured Top of Right bracket



\*Pictured Bottom of Right bracket

## The BOOST+ is a new and improved range featuring:

- LED digital controller with 3 pre-set programmable heights and easy to use up & down arrows
- 120kg weight lifting capacity on Workstations and 140kg capacity on Corner Desks
- Smooth & quiet adjustment at 38mm per second
  - Anti-collision and anti-tilt safety features
  - Dual motor with 3 stage motorised legs
- Keypad safety lock and reminder alarm setting
  - Adjustable levelling feet
  - Low noise emissions
  - Easy assembly

### New Sizes and Configurations:

- Now available in open Desk, Desk with Return and Corner Workstations
  - 3 Open desk sizes and 3 corner workstation sizes
  - Mix and Match 2 top colours with 2 frame colours
- Height range of 620mm - 1270mm H to meet **Australian Standards**
  - 750mm depth top with scalloped cable access

### Optional Add-Ons:

- Optional integrated cable tray
- Optional 900mm H, full fabric, pinnable screen for privacy
- Screens available in 2 standard fabrics or our range of Rapidline Upholstery Fabrics on page 69

### Optional Accessories:

- Optional Bluetooth control to work with your smart mobile devices
- Optional Portable Battery Packs allow desk mobility free from GPOs
  - Cable snake to make managing wiring simple
  - Cable tray bridge for cable management of runs of workstations

## BOOST+ CORNER

The Boost+ Corner is a height adjustable corner workstation available in 3 sizes. With a weight capacity of 140kgs and a cable entry hole on the workstation top.

Product Code	Screen	Cable Tray	Size
B+CNR1P1515	No	No	1500 x 1500mm
B+CNRCT1P1515	No	Yes	1500 x 1500mm
B+CNRWS1P1515	Yes	No	1500 x 1500mm
B+CNRWSCT1P1515	Yes	Yes	1500 x 1500mm
B+CNR1P1815	No	No	1800 x 1500mm
B+CNRCT1P1815	No	Yes	1800 x 1500mm
B+CNRWS1P1815	Yes	No	1800 x 1500mm
B+CNRWSCT1P1815	Yes	Yes	1800 x 1500mm
B+CNR1P1818	No	No	1800 x 1800mm
B+CNRCT1P1818	No	Yes	1800 x 1800mm
B+CNRWS1P1818	Yes	No	1800 x 1800mm
B+CNRWSCT1P1818	Yes	Yes	1800 x 1800mm

### Top Options :



### Frame Finishes :



### Screen Finishes :

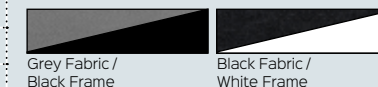

### Certifications :



<- Natural Oak top with Black Frame

Natural Oak top with Black Frame -> With Screen and Cable tray



## BOOST+ SINGLE DESK

The Boost+ Single Desk comes in 3 widths in our standard range of melamine colours. All tops come with a scalloped edge for cable access. Choose to add on a cable tray, a screen or both.

Product Code	Screen	Cable Tray	Width
B+1P1275	No	No	1200mm
B+1P1575	No	No	1500mm
B+1P1875	No	No	1800mm
B+1PCT1275	No	Yes	1200mm
B+1PCT1575	No	Yes	1500mm
B+1PCT1875	No	Yes	1800mm
B+1PWS1275	Yes	No	1200mm
B+1PWS1575	Yes	No	1500mm
B+1PWS1875	Yes	No	1800mm
B+1PWST1275	Yes	Yes	1200mm
B+1PWST1575	Yes	Yes	1500mm
B+1PWST1875	Yes	Yes	1800mm

### Top Options :

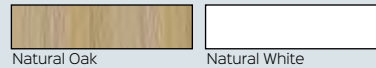

### Frame Finishes :



### Screen Finishes :

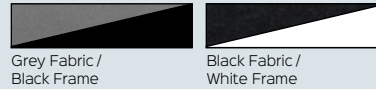

### Certifications :



## BOOST+ RETURN FRAME

The Boost+ Return frame can be used with the BOOST+ single desk to create a 2-piece top corner workstation with a 90 degree corner. Total weight capacity of 140kg evenly spread. \*Top sold seperately\*

Product Code	Width	Height
B2-RF	735 - 1845mm	620 - 1270mm

### Frame Options :



Our stocked return top creates an 1800 x 1800mm overall desk and return.

Product Code	Width	Depth	Height
T116	1100mm	600mm	25mm

### Top Options :

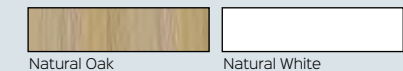

An alternative to the cockpit style corner workstation tops on the Boost+ Corner. And a convenient add-on to a straight Boost+ Single Desk.

### Certifications :



\*Included Memory Controller  
Displays height on left  
Easy up and down arrows  
Save up to 3 set heights



# BOOST+ HEIGHT ADJUSTABLE

## BOOST+ BACK TO BACK DESK

The Boost+ Single Desk comes in 3 widths in our standard range of melamine colours. All tops come with a scalloped edge for cable access. Choose to add on a cable tray, a screen or both.

Product Code	Screen	Cable Tray	Width
B+2P1275	No	No	1200mm
B+2P1575	No	No	1500mm
B+2P1875	No	No	1800mm
B+2PCT1275	No	Yes	1200mm
B+2PCT1575	No	Yes	1500mm
B+2PCT1875	No	Yes	1800mm
B+2PWS1275	Yes	No	1200mm
B+2PWS1575	Yes	No	1500mm
B+2PWS1875	Yes	No	1800mm
B+2PWSCT1275	Yes	Yes	1200mm
B+2PWSCT1575	Yes	Yes	1500mm
B+2PWSCT1875	Yes	Yes	1800mm

### Top Options :

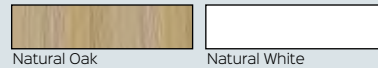

### Frame Finishes :



### Screen Finishes :



### Certifications :



Natural White top with White Frame  
Corner workstation

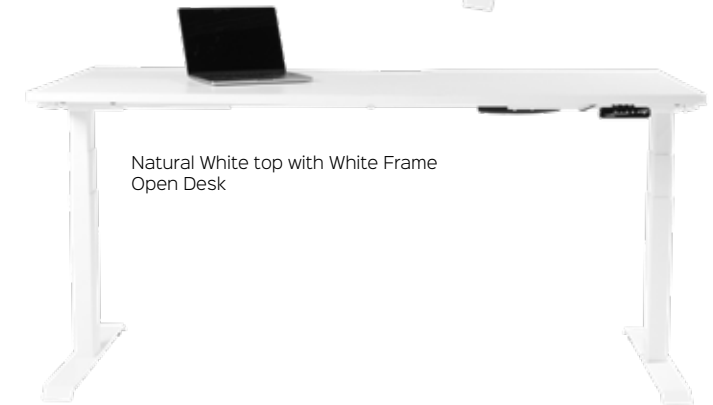

Natural White top with White Frame  
Open Desk

Natural White top with Black Frame ->  
With Screen and Cable tray.



<- Use additional Cable snakes to manage and safely carry cables from the desk to cable tray.



Natural White top with White Frame  
Back to Back.  
\*Pictured chair not included

## RAPID FLUX

### Specifications :

Top Width	• RF1 - 880mm • RF2 - 950mm
Depth	Overall - 590mm, Top - 415mm
Height	120mm - 500mm
Weight Capacity	25kg on Top

### Finish Options :



### Features :

- Electric height adjustable solution for fixed desk
- 22mm per second speed
- Hidden motor makes for a compact design
- Grommet Hole in Worktop for Use with Monitor Arms

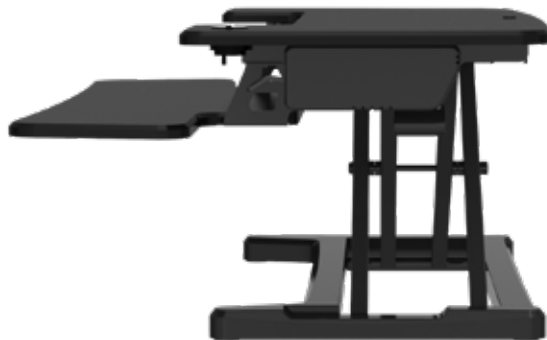

## RAPID RISER

### Specifications :

Top Width	• RR1 - 680mm • RR2 - 890mm
Top Depth	590mm
Height	150mm - 500mm
Weight Capacity	15kg Weight Capacity on RR1 18kg Weight Capacity on RR2

### Finish Options :



### Features :

- Manual height adjustable solution for fixed desk
- 15 Different height level settings
- Comes with hole for monitor arm installation



## TRIUMPH MANUAL HEIGHT ADJUSTABLE

### Specifications :

Top Width	• TMA127 - 1200mm • TMA157 - 1500mm • TMA187 - 1800mm
Top Depth	700mm
Height	715-1015mm
Weight Capacity	100kg on Top

### Top Finishes :



### Frame :



### Features :

- Manual height adjustable desk
- Universal left or right hand side crank handle
- Intergrated cable dump tray



## RAPID REFRESH MAT - RRM BL

### Specifications :

Width	900mm
Depth	600mm
Thickness	19mm
Weight	2.4kg

### Features :

- Anti-fatigue mat
- 100% PU material
- Use with any height adjustable solution
- Updated Design

### Top Finishes :





# MONITOR ARMS

## EXECUTIVE SINGLE MONITOR ARM - ESMARM

### Specifications :

Tilt Range	-85° to 15°
Screen Size	17" to 27"
Vesa Size	75 x 75mm or 100 x 100mm
Weight Limit	Min. 2kg - Max 9kg
Fixing	Clamp and Grommet Fix Kit

### Finish Options :



### Features :

- Gas spring single monitor arm with effortless rotating, pivoting and extendable adjustments.



## REVOLVE SINGLE MONITOR ARM - RMA1 BL

### Specifications :

Arm Reach	435mm
Pole Height	392mm
Height	200-340mm
Weight Limit	10kg
Movement Range	-85° to 15°

### Finish Options :



### Features :

- Pole mounted single monitor arm with 200-340mm height range and cable management within.



## ELEVATE SINGLE MONITOR ARM - ELEVATE

### Specifications :

Forward Range	500mm
Vertical Range	180-480mm
Size Limit	Up to 24 Inch Monitor
Weight Limit	Min. 2kg - Max 8kg
Movement Range	180°

### Finish Options :

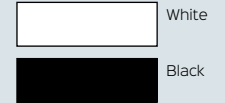

### Features :

- Single swivel monitor arm with 180-480mm height range, 180° degree adjustment and clamp fix kit.



## EXECUTIVE DUAL MONITOR ARM - EDMARM

### Specifications :

Tilt Range	-85° to 15°
Screen Size	17" to 27"
Vesa Size	75 x 75mm or 100 x 100mm
Weight Limit	Min. 2kg - Max 9kg per Arm
Fixing	Clamp and Grommet Fix Kit

### Finish Options :



### Features :

- Gas spring dual monitor arms with effortless rotating, pivoting and extendable adjustments.



## REVOLVE DUAL MONITOR ARM - RMA2 BL

### Specifications :

Arm Reach	360mm per Arm
Pole Height	450mm
Height	260-360mm
Weight Limit	10kg per Arm
Movement Range	-85° to 15°

### Finish Options :

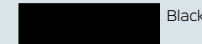

### Features :

- Pole mounted dual monitor arm with 260-360mm height range and cable management within, in black finish.



## REVOLVE QUAD MONITOR ARM - RMA4 BL

### Specifications :

Arm Reach	360mm per Arm
Pole Height	708mm
Height	200-660mm
Weight Limit	10kg per Arm
Movement Range	-85° to 15°

### Finish Options :

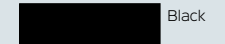

### Features :

- Pole mounted quad monitor arm with 200-660mm height range and cable management within, in black finish.



## RAPID SCREEN STRAIGHT PODS



## RAPID SCREEN CORNER PODS



## RAPID SCREEN 120° DEGREE PODS



Create a layout to suit your space with a huge selection of tops, legs, and colours to choose from.

### Components :

Top Options	Beech or Natural White with cable entry holes T127 - 1200mm W x 700mm D T157 - 1500mm W x 700mm D T187 - 1800mm W x 700mm D
Screen Options	Blue or Grey fabric with ironstone bottom SC712 - 750mm W x 1250mm H x 30mm T SC1212 - 1200mm W x 1250mm H x 30mm T SC1512 - 1500mm W x 1250mm H x 30mm T SC1812 - 1800mm W x 1250mm H x 30mm T SC716 - 750mm W x 1650mm H x 30mm T SC1216 - 1200mm W x 1650mm H x 30mm T SC1516 - 1500mm W x 1650mm H x 30mm T SC1816 - 1800mm W x 1650mm H x 30mm T
Leg Options	DC60 - Round leg in Chrome, Black or White SPLEG - Span leg in Silver, Black or White C LEG - C Leg in Silver only
Joining Pole	Precious Silver SC12/90 - 90° Degree Pole for 1200mm Height SC16/90 - 90° Degree Pole for 1600mm Height

Encourage teamwork while providing privacy.

### Components :

Top Options	Beech or Natural White with cable entry hole T1515 - 1500mm x 1500mm, 700mm Top Depth T1812 - 1800mm x 1200mm, 700mm Top Depth T1815 - 1800mm x 1500mm, 700mm Top Depth T1818 - 1800mm x 1800mm, 700mm Top Depth
Screen Options	Blue or Grey fabric with ironstone bottom SC712 - 750mm W x 1250mm H x 30mm T SC1212 - 1200mm W x 1250mm H x 30mm T SC1512 - 1500mm W x 1250mm H x 30mm T SC1812 - 1800mm W x 1250mm H x 30mm T SC716 - 750mm W x 1650mm H x 30mm T SC1216 - 1200mm W x 1650mm H x 30mm T SC1516 - 1500mm W x 1650mm H x 30mm T SC1816 - 1800mm W x 1650mm H x 30mm T
Leg Options	DC60 - Round leg in Chrome, Black or White SPLEG - Span leg in Silver, Black or White C LEG - C Leg in Silver only
Joining Pole	Precious Silver SC12/90 - 90° Degree Pole for 1200mm Height SC16/90 - 90° Degree Pole for 1600mm Height

Spacious workstations per user while still providing sufficient privacy.

### Components :

Top Options	Beech or Natural White with cable entry hole T1212-12-7 - 120° Degree Top 1200mm W x 1200mm W x 700mm D
Screen Options	Blue or Grey fabric with ironstone bottom SC712 - 750mm W x 1250mm H x 30mm T SC1212 - 1200mm W x 1250mm H x 30mm T SC716 - 750mm W x 1650mm H x 30mm T SC1216 - 1200mm W x 1650mm H x 30mm T
Leg Options	DC60 - Round leg in Chrome, Black or White SPLEG - Span leg in Silver, Black or White C LEG - C Leg in Silver only
Joining Pole	Precious Silver SC12/120 - 120° Degree Pole for 1200mm Height SC16/120 - 120° Degree Pole for 1600mm Height

### Certifications :



# RAPID SCREEN COMPONENTS

## CHOOSE YOUR TABLE TOP

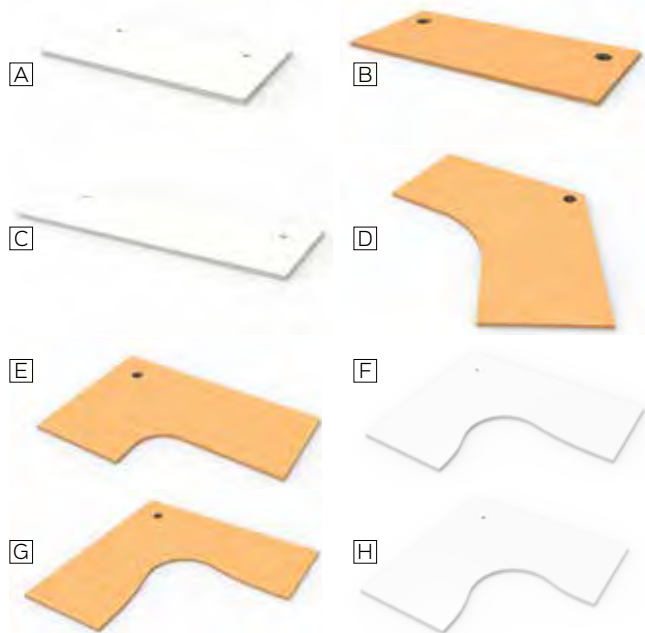

### Specifications :

Key	Code	Width	Depth	Thickness
A	T127	1200mm	700mm	25mm
B	T157	1500mm	700mm	25mm
C	T187	1800mm	700mm	25mm
D	T1212-12-7	1200 x 1200mm	700mm	25mm
E	T1812	1800 x 1200mm	700mm	25mm
F	T1815	1800 x 1500mm	700mm	25mm
G	T1818	1800 x 1800mm	700mm <td 25mm	
H	T1515	1500 x 1500 mm	700mm	25mm

### Finish Options :

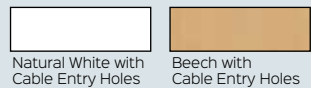

### Certifications :



The Rapid Screen system allows ultimate flexibility to suit your space. Different top shapes and sizes, screen heights, leg options and storage choices allow for personalised workstation design.

## CHOOSE YOUR LEG STYLE



### Specifications :

Key	Code	Description	Dimensions	Qty
I	SPLEG	Span Leg	560W x 705H	2
J	DC60	Round Leg	60 Dia. x 705H	4
K	CLEG	C Leg	550W x 705H	2

### Finish Options :

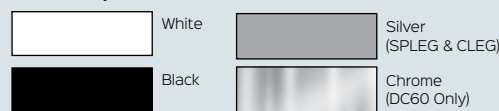

### Certifications :



## JOINING POLES



### Specifications :

Key	Code	Description	Dimensions
L	SC12/90	Join screens at 90°	30 Dia. x 1250 H
L	SC12/120	Join screens at 120°	30 Dia. x 1250 H
M	SC16/90	Join screens at 90°	30 Dia. x 1650 H
M	SC16/120	Join screens at 120°	30 Dia. x 1650 H

### Finish :

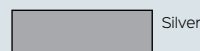

### Certifications :



## CHOOSE YOUR SCREEN

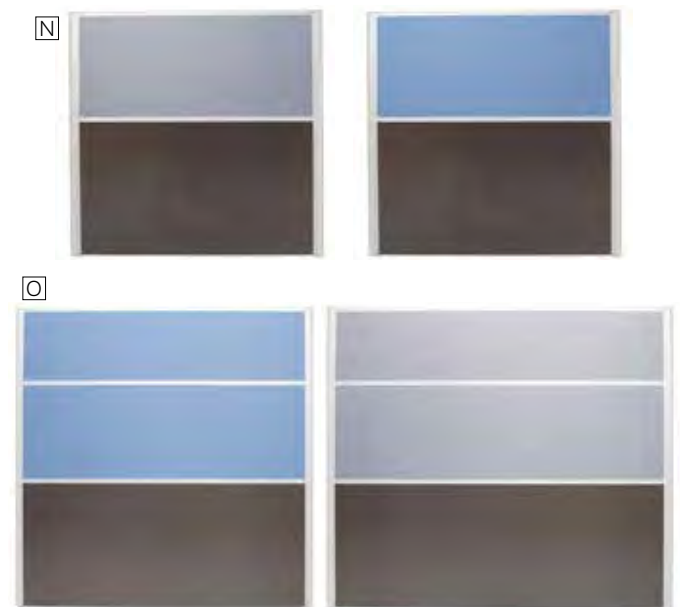

### Specifications :

Key	Code	Width	Depth	Height
N	SC1212	1200mm	30mm	1250mm
-	SC1512	1500mm	30mm	1250mm
-	SC1812	1800mm	30mm	1250mm
-	SC712	750mm	30mm	1250mm
-	SC1216	1200mm	30mm	1650mm
O	SC1516	1500mm	30mm	1650mm
-	SC1816	1800mm	30mm	1650mm
-	SC716	750mm	30mm	1650mm

### Finish Options :

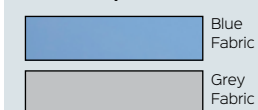

### Certifications :



Rapidline Upholstery

Page 69

### Features :

- Fabric top half can be upholstered in a range of Rapidline Upholstery fabrics with an additional lead time and cost



## CHOOSE YOUR SCREEN ACCESSORIES

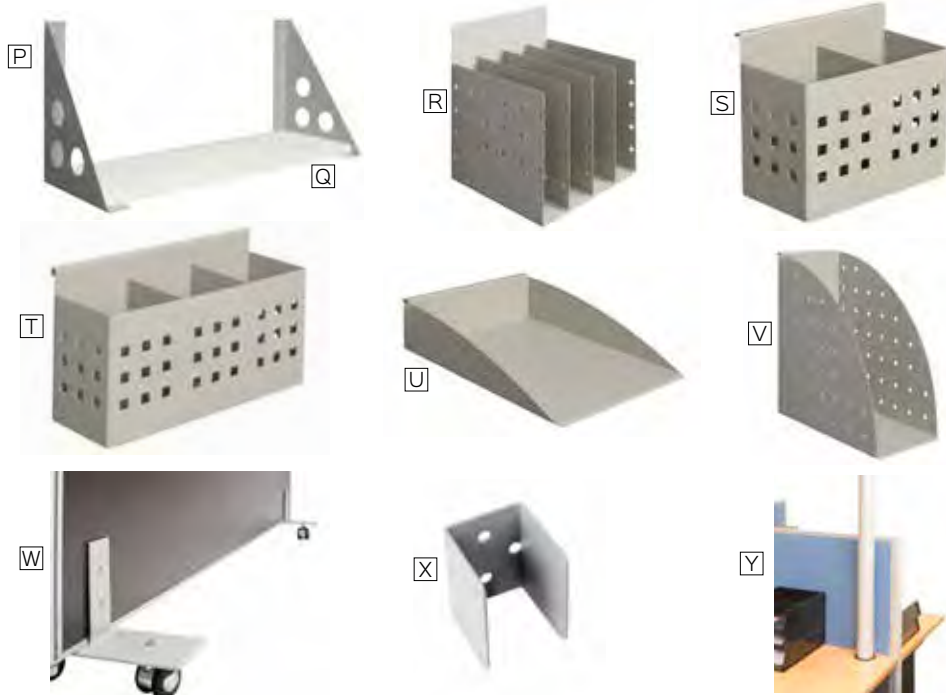

### Specifications :

Key	Code	Description	Colour
P	SCSHELF BRACKET	Shelf Brackets	Silver
Q	SCSHELF	900mm W Shelf	Natural White or Beech
R	SCDOC DIVIDE	4 Space Document Divider	Silver
S	SCPENHOLDER 2	Double Pen Holder	Silver
T	SCPENHOLDER 3	Triple Pen Holder	Silver
U	SCDOCTRAY	A4 Document Tray	Silver
V	SCFILE HOLDER	File Holder	Silver
W	SCFREE STANDING FEET	Free Standing Detachable Castor Feet	Silver
X	SCWALLBRACKET	Wall to Screen Starter Bracket	Silver
Y	SW2.1 POWER POLE or SW2.8 POWER POLE	Power Pole Available in 2100mm or 2800mm Height	Silver

### Finish :

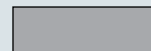

Silver

### Shelf Finish Options :



Natural White



Beech

### Certifications :

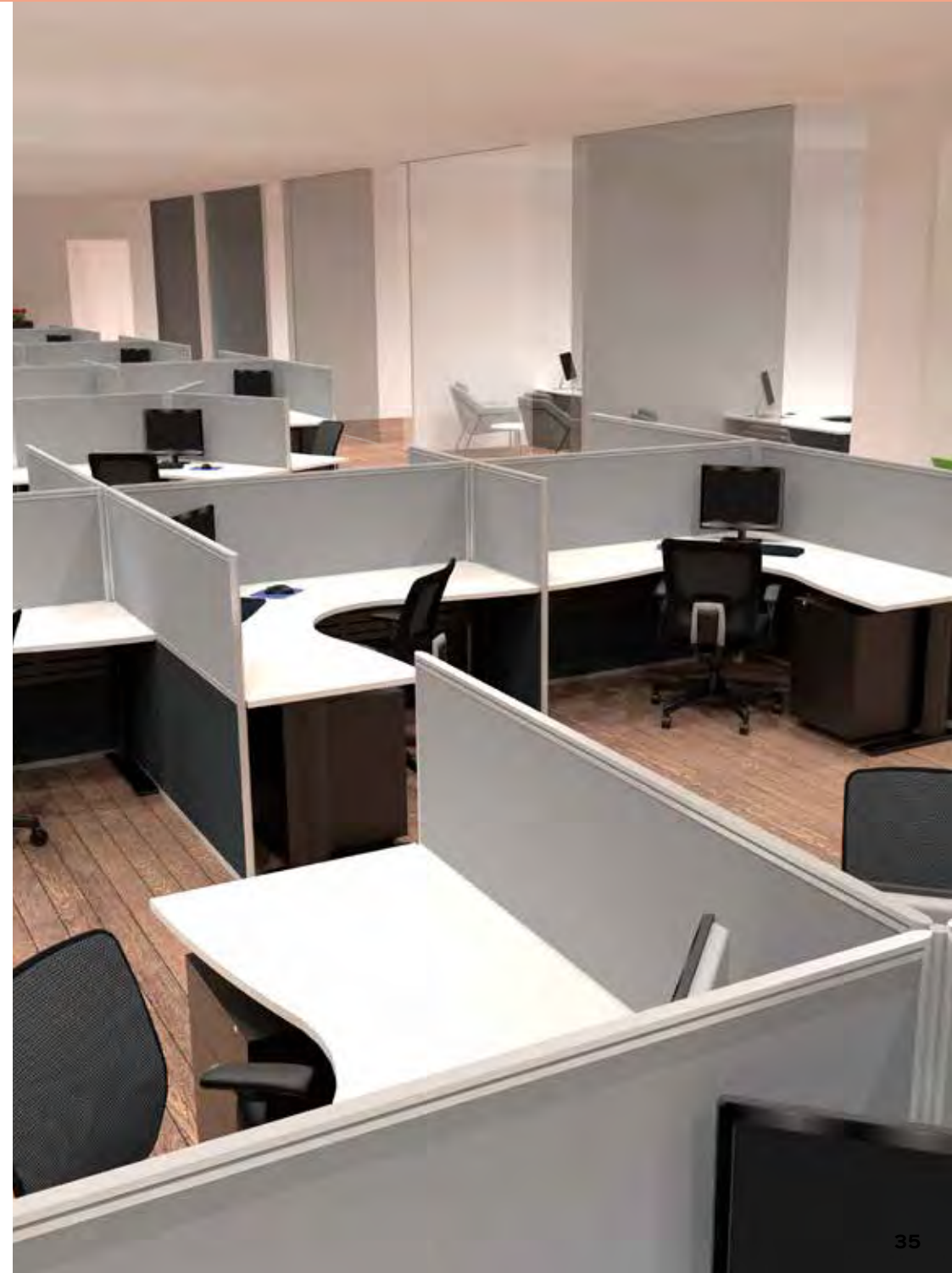

# DELUXE RAPID SPAN

## STRAIGHT DESKS



**RSD1275M WNO**  
White Frame  
Natural Oak Top with Scalloped Edge



**RSD1575M SNO**  
Silver Frame  
Natural Oak Top with Scalloped Edge



**RSD1875M BNO**  
Black Frame  
Natural Oak Top with Scalloped Edge

## CORNER WORKSTATIONS



**RSCWS181275M WNO**  
1800 x 1200mm Corner Top | White Frame  
Natural Oak Top with Single Cable Entry Hole



**RSCWS181575M SNO**  
1800 x 1500mm Corner Top | Silver Frame  
Natural Oak Top with Single Cable Entry Hole



**RSCWS181875M BNO**  
1800 x 1800mm Corner Top | Black Frame  
Natural Oak Top with Single Cable Entry Hole

Deluxe Rapid Span - 750mm Deep desk top in Natural Oak or Natural White finish. Top matches Deluxe Infinity Storage.

The Span range of desking can be configured in back to back desk layouts and pods of workstations as well as stand alone desks. Contact us today for more information.

### Desk Size Options :

Product Code	Width	Top Depth	Height
RSD1275M	1200mm	750mm	730mm
RSD1575M	1500mm	750mm	730mm
RSD1875M	1800mm	750mm	730mm

### Corner Workstation Size Options :

Product Code	Width	Top Depth	Height
RSCWS181275M	1800 x 1200mm	750mm	730mm
RSCWS151575M	1500 x 1500mm	750mm	730mm
RSCWS181575M	1800 x 1500mm	750mm	730mm
RSCWS181875M	1800 x 1800mm	750mm	730mm

### Top Finish :



### Certifications :



### Frame Finishes :

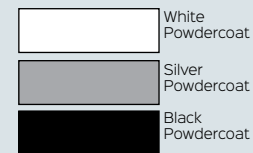

### Features :

- Sturdy powdercoated frame and legs
- Comes with metal perforated modesty panel
- Range of sizes to choose from to suit your space
- E0 Melamine top
- Pre cut cable entry hole or scalloped edge
- 750mm Deep top for more workspace
- Hidden cable tidy in legs
- Adjustable feet
- Use with Deluxe Infinity storage. (See page 21)

## STRAIGHT DESKS



**RSD187M WNW**  
White Frame  
Natural White Top with Cable Entry Holes



**RSD187M SB**  
Silver Frame  
Beech Top with Cable Entry Holes



**RSD187M BNW**  
Black Frame  
Natural White Top with Cable Entry Holes

## CORNER WORKSTATIONS



**RSCWS1818M BB**  
Corner Workstation | Black Frame  
Beech Top with Single Cable Entry Hole



**RSCWS1818M SNW**  
Corner Workstation | Silver Frame  
Natural White Top with Single Cable Entry Hole



**RSDR1818M WB**  
Desk and Return | White Frame  
Beech Top with Cable Entry Holes

Rapid Span Desks - Mix and match colours and sizes.

The Rapid Span range of desking can be configured in back to back desk layouts and pods of workstations as well as stand alone desks. All desks and corner workstations are 700mm deep.

Contact us today for more information.

### Desk Size Options :

Product Code	Width	Depth	Height
RSD1277M	1200mm	700mm	730mm
RSD1577M	1500mm	700mm	730mm
RSD1877M	1800mm	700mm	730mm

### Corner Workstation Size Options :

Product Code	Width	Depth	Height
RSCWS18127M	1800 x 1200mm	700mm	730mm
RSCWS15157M	1500 x 1500mm	700mm	730mm
RSCWS18157M	1800 x 1500mm	700mm	730mm
RSCWS18187M	1800 x 1800mm	700mm	730mm

### Desk with Return Size :

Product Code	Width	Depth	Height
RSDR1818M	1800mm x 1800mm (1100 x 600mm D Return)	700mm	730mm

### Top Finishes :



### Frame Finishes :

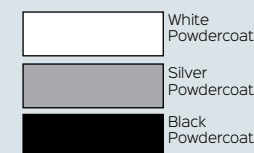

### Certifications :



### Features :

- Mix and match choice of 2 top colours and 3 frame colours
- E0 Melamine top with pre cut cable entry hole
- Sturdy powdercoated frame and legs
- Comes with metal perforated modesty panel
- Range of sizes to choose from to suit your space
- Pre cut cable entry holes
- 700mm Deep top to suit smaller spaces (600mm D return in RSD1818M)
- Hidden cable tidy in legs
- Adjustable feet



# RAPID SPAN STORAGE

## RAPID SPAN CUPBOARD - SP2FD18

### Specifications :

Width	900mm
Depth	450mm
Height	1800mm

### Features :

- Includes 1 x fixed mid shelf
- 3 x adjustable shelves
- Soft close hinges
- Fully lockable with 2 keys included
- E0 Melamine board

### Finish Options :



### Certifications :



## RAPID SPAN BOOKCASE

### Specifications :

Width	900mm
Depth	315mm
Height	• SPBC12 - 1200mm
Options	• SPBC18 - 1800mm

### Features :

- E0 Melamine board
- 1200mm H comes with 3 x adjustable shelves, 1800mm H comes with 4 x adjustable shelves.

### Finish Options :



### Certifications :



## RAPID SPAN CREDENZA

### Specifications :

Width	• SPC12 - 1200mm
Options	• SPC18 - 1800mm
Depth	450mm
Height	730mm

### Features :

- Sliding door credenza
- Includes 2 x adjustable shelves
- Fully lockable with 2 keys included
- E0 Melamine board

### Finish Options :



### Certifications :



## UNDER DESK STORAGE - SPMP3

### Specifications :

Width	447mm
Depth	465mm
Height	690mm
Weight Rating	30kg per Drawer

### Features :

- Melamine mobile pedestal on castors
- 2 x personal drawers and 1 x file drawer
- Lockable with key, 2 keys supplied
- E0 Melamine board

### Top Finishes :



### Certifications :



## RAPID SPAN HUTCH

### Specifications :

Width	• SPH12 - 1200W - 2 Vertical sections
Options	• SPH18 - 1800W - 3 vertical sections
Depth	315mm
Height	1070mm

### Features :

- Includes adjustable shelves
- Sits on top of credenza
- Provides extra storage space
- E0 Melamine board

### Finish Options :

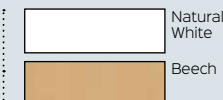

### Certifications :





## RAPID WORKER STRAIGHT DESK

### Specifications :

Top Size Options	<ul style="list-style-type: none"> <li>• CDK96 - 900mm W x 600mm D</li> <li>• CDK126 - 1200mm W x 600mm D</li> <li>• CDK1575 - 1500mm W x 750mm D</li> <li>• CDK1875 - 1800mm W x 750mm D</li> <li>• CDK189 - 1800mm W x 900mm D</li> </ul>
Height	730mm

### Features :

- E0 Melamine board
- CDK96 with 1 Cable entry hole, all other sizes with 2 cable entry holes
- Modesty panel
- Can be used with fixed pedestals
- Can be used with return to create more work surface area

### Finish Options :

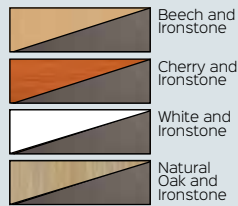

### Certifications :



## RAPID WORKER DESK RETURN

### Specifications :

Desk Return	• CR45 - 900mm W x 450mm D
Size Options	<ul style="list-style-type: none"> <li>• CR6 - 900mm W x 600mm D</li> <li>• CR12 - 1200mm W x 600mm D (Beech &amp; Cherry Only)</li> </ul>
Height	730mm

### Features :

- E0 Melamine board
- Add to straight desk to create a return
- Creates more desk top space
- Includes modesty panel piece

### Finish Options :

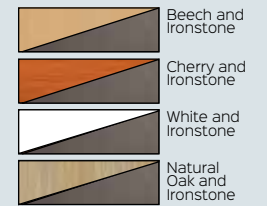

### Certifications :



\*Beech / Ironstone CDK126



\*Cherry / Ironstone CDK96



\*White / Ironstone CDK1875

NEW



\*Natural Oak / Ironstone CDK189

NEW



\*Beech / Ironstone



\*Cherry / Ironstone



\*Natural Oak / Ironstone

NEW



\*Natural Oak / Ironstone  
Left hand return on a CDK1575 (CDK1575 not included)

NEW



\*Natural White / Ironstone  
Left hand Return on a CDK189 (CDK189 not included)



## RAPID WORKER CORNER WORKSTATION

### Specifications :

Desk Size Options	• RWCWS1212 - 1200 x 1200mm	• RWCWS1215 - 1200 x 1500mm
	• RWCWS1218 - 1200 x 1800mm	• RWCWS1221 - 1200 x 2100mm
	• RWCWS1515 - 1500 x 1500mm	• RWCWS1815 - 1800 x 1500mm
	• RWCWS1818 - 1800 x 1800mm	• RWCWS2115 - 2100 x 1500mm
	• RWCWS2118 - 2100 x 1800mm	• RWCWS2121 - 2100 x 2100mm
Height	730mm	
Depth	600mm (or 750mm in 1800 x 1800mm* In Beech and Cherry only)	

### Finish Options :

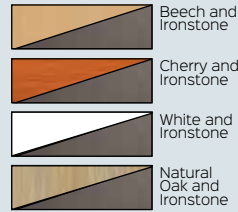

### Features :

- 3-piece corner workstation
- Huge range of sizes to suit your space
- Cable entry hole in corner piece
- Modesty panels with space for cable access

### Certifications :



## RAPID WORKER FIXED PEDESTAL

### Options :

CDKP1D1F	1 Drawer and 1 File Drawer 465W x 447D x 454H
CDKP3D	3 Drawers 465W x 447D x 454H
CRP3D	3 Drawers (For Return) *In Ironstone only 465W x 370D x 454H

### Finish Options :

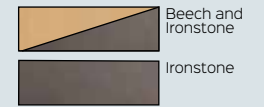

### Features :

- Install on Right or Left side of Desk
- E0 Melamine board
- Lockable, 2 keys supplied

### Certifications :



\*Beech / Ironstone  
1500 x 1500mm



\*Cherry / Ironstone  
1800 x 1800mm



\*Natural Oak / Ironstone  
1800 x 1800mm

NEW



NEW



\*CRP3D Return Fixed Pedestal  
Pictured on a Natural White Return

NEW

## CUPBOARD - CSC2FD

### Specifications :

Width	900mm
Depth	450mm
Height	1800mm

### Finish Options :

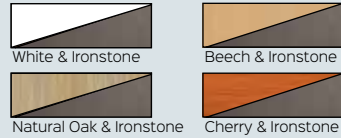

### Features :

- 3 x adjustable shelves
- 1 x fixed middle shelf
- Fully lockable with 2 keys included

### Certifications :



## BOOKCASE

### Specifications :

Height	• CBC9 - 900mm
	• CBC12 - 1200mm
	• CBC18 - 1800mm
Width	900mm
Depth	315mm

### Finish Options :



### Features :

- 3 x adjustable shelves in 900 and 1200 H
- 4 x adjustable shelves in 1800 H

### Certifications :



## LOCKABLE WALL UNIT - CSC2HD

### Specifications :

Width	900mm
Depth	450mm
Height	1800mm

### Finish Options :

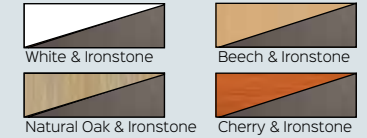

### Features :

- Lockable half height storage
- 2 adjustable shelves
- Supplied with 2 keys

### Certifications :



## FILING CABINET

### Specifications :

Width	465mm
Depth	600mm
Height	• C3FC - 998mm • C4FC - 1300mm

### Finish Options :

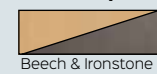

### Features :

- Melamine 3 or 4 drawer filing cabinet
- Lockable, supplied with 2 keys
- Metal runner arms

### Certifications :



## PIGEON HOLE UNIT - PH20

### Specifications :

Width	1040mm
Depth	380mm
Height	1040mm

### Finish Options :



### Features :

- Melamine pigeon hole unit
- 20 slots
- Adjustable shelves

### Certifications :



## EXTRA SHELVES

### Specifications :

CBC SHELF	• 890W x 420D x 25T • Use with Bookcases
FD SHELF	• 858W x 405D x 18T • Use with Cupboards

### Finish Options :

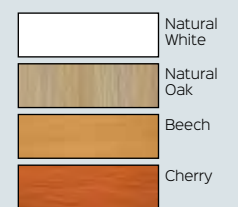

### Certifications :



## CREDENZA

### Specifications :

Width	<ul style="list-style-type: none"> <li>• CMZ1245 - 1200mm</li> <li>• CMZ1545 - 1500mm</li> <li>• CMZ1845 - 1800mm</li> </ul>
Depth	450mm
Height	730mm

### Features :

- E0 Melamine board
- 2 x adjustable shelves
- Fully lockable sliding door with 2 keys

### Certifications :



### Finish Options :

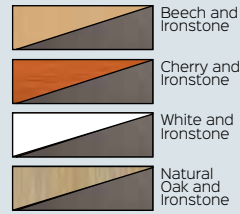

## RAPID WORKER HUTCH

### Specifications :

Width	<ul style="list-style-type: none"> <li>• CH12 - 1200mm</li> <li>• CH15 - 1500mm</li> <li>• CH18 - 1800mm</li> </ul>
Depth	315mm
Height	1070mm

### Features :

- 4 shelves in 1200mm and 1500mm sizes
- 6 shelves in 1800mm size
- E0 Melamine board

### Certifications :



### Finish Options :

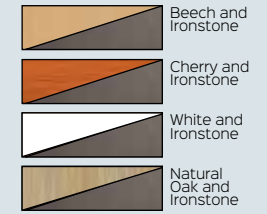

## RAPID WORKER MOBILE PEDESTAL

### Specifications :

CMP2F	2 Drawers
CMP2D1F	2 Drawers and 1 File Drawer
CMP4D	4 Drawers
Size	447mm x 465mm x 690mm

### Features :

- Drawers with metal runners
- Key locking - 2 keys supplied

### Certifications :



### Finish Options :

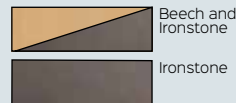

## RAPID WORKER DESK HOB

### Specifications :

CHOB15N	• 1500W x 350D
CHOB18N	• 1800W x 350D
Height	400mm

### Features :

- Creates a reception counter or privacy for your straight or corner desk

### Certifications :



### Finish Options :

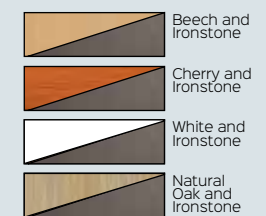



## RAPID VIBE LAPTOP DESK - CDK96

### Specifications :

Width	900mm
Depth	600mm
Height	730mm

### Finish Options :



### Certifications :



### Features :

- E0 Melamine open desk
- Compact size for laptop or hot desk
- Matching under desk modesty panel



## RAPID VIBE OPEN DESK

### Specifications :

Top Size	• CDK126 - 1200W x 600D
Options	• CDK1575 - 1500W x 750D
	• CDK189 - 1800W x 900D
Height	730mm

### Finish Options :



### Certifications :



### Features :

- E0 Melamine open desk
- Matching under desk modesty panel
- Use with Desk Return for more workspace and to create a corner workstation



## RAPID VIBE DESK RETURN - CR6

### Specifications :

Width	900mm
Depth	600mm
Height	730mm

### Finish Options :

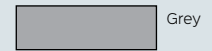

### Certifications :



### Features :

- E0 Melamine return
- Fix to any straight desk
- Create a corner shaped workstation
- Extra desk top space



## RAPID VIBE PEDESTALS

### Specifications :

CDKP3D Fixed Pedestal	465W x 447D x 454H 3 Drawers
SPMP3 Mobile Pedestal	447W x 465D x 690H 2 Drawers and 1 File

### Finish Options :

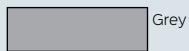

### Certifications :



### Features :

- Lockable with 2 keys supplied
- Metal runners
- Fifth wheel for stability in Mobile Pedestal
- Silver handles
- E0 Melamine board



## RAPID VIBE CORNER WORKSTATION - CWS1818

### Specifications :

Overall Width	1800mm x 1800mm
Top Depth	600mm
Height	730mm

### Finish Options :

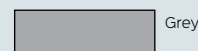

### Certifications :



### Features :

- E0 Melamine board
- 3 Piece corner workstation
- Under desk modesty panels
- 1 x 80mm cable entry hole in corner



## RAPID VIBE DESK HOB - CHOB18N

### Specifications :

Width	1800mm
Depth	350mm
Height	400mm

### Finish Options :

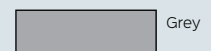

### Certifications :



### Features :

- Straight edge hob
- Use on straight or corner desk
- Creates a reception counter
- Add privacy to a desk
- E0 Melamine board



## RAPID VIBE CUPBOARD - SP2FD18

### Specifications :

Width	900mm
Depth	450mm
Height	1800mm

### Features :

- Full door cupboard
- 1 x fixed mid shelf
- 3 x adjustable shelves
- Fully lockable with 2 keys included
- E0 Melamine board

### Finish Options :



### Certifications :



## RAPID VIBE BOOKCASE

### Specifications :

Width	900mm
Depth	315mm
Height	• SPBC12 - 1200mm • SPBC18 - 1800mm

### Features :

- Open bookcase
- 1200mm H with 3 x adjustable shelves
- 1800mm H with 4 x adjustable shelves
- E0 Melamine board

### Finish Options :



### Certifications :



## RAPID VIBE HUTCH

### Specifications :

Width	• SPH12 - 1200mm • SPH18 - 1800mm
Depth	315mm
Height	1070mm

### Features :

- Includes adjustable shelves
- 1200mm W with 2 vertical sections
- 1800mm W with 3 vertical sections
- E0 Melamine board

### Finish Options :

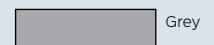

### Certifications :



## RAPID VIBE CREDENZA

### Specifications :

Width	• SPC12 - 1200mm • SPC18 - 1800mm
Depth	450mm
Height	730mm

### Features :

- Sliding door credenza
- 2 x adjustable shelves
- Fully lockable with 2 keys included
- E0 Melamine board

### Finish Options :

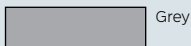

### Certifications :



# CABLE MANAGEMENT SOLUTIONS

## ECHO WIRELESS CHARGER

### Specifications :

Width	60mm Diameter
Power	15W Wireless fast charge
ECHOWCTL	500mm TAG lead with L3F splitter
ECHOWCTPP	1500mm 3-pin lead

### Finish Options :



### Certifications :



### Features :

- Wireless fast charging module that can fit into desk top. \*Check compatibility with phone brand\*



## ODYSSEY POWER DOCK

### Specifications :

ODYS2G2USBTTP	2 x GPO + 1 x USB A + 1 x USB C + 1500mm 3-pin lead
ODYS4G4USBTTP	4 x GPO + 2 x USB A + 2 x USB C + 1500mm 3-pin lead
ODYS8G4USBTTP	8 x GPO + 2 x USB A + 2 x USB C + 1500mm 3-pin lead

### Finish Options :



### Certifications :



### Features :

- The complete power solution for where shared power is needed. Use in boardrooms, conference areas, hot desking or meeting.



## ATOM USB CHARGING MODULE

### Specifications :

ATOMUSB	2 x USB + 1500mm 3-pin lead
ATOMBRACK	Under Desk & Lounge Mounting Bracket

### Finish Options :



### Certifications :



### Features :

- USB charging module
- Can be integrated into desk top or fixed underneath desk top, or mounted to lounges with a mounting bracket.



## BLINKY POWER POD

### Specifications :

Size	Fits in 135mm Diameter cutout
BLKY3GTL	3 x GPO + 500mm TAG lead
BLKY3GTPP	3 x GPO + 1500mm 3-pin lead
BLKY3G3USBTTL	3 x GPO + 3 x USB C + 500mm TAG lead
BLKY3G3USBPP	3 x GPO + 3 x USB C + 1500mm 3-pin lead

### Features :

- Multi-power pod with different power configurations available
- Sits on desk top

### Finish Options :



### Certifications :



## POWER POLE AND UMBILICAL - SW2.1 | SW2.8

### Specifications :

Desk to Ceiling	2.1m power pole or umbilical kit for desk to ceiling power
Kit Includes	with ceiling kit, under desk mounting bracket, desk grommet and cover
Floor to Ceiling	2.8m power pole or umbilical kit for floor to ceiling power
Kit Includes	power with ceiling kit, floor bracket and cover

### Features :

- Carries cables and wiring to your desk from the ceiling
- Perfect for open plan offices for desks in the centre of the room

### Finish Options :

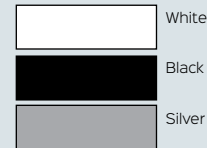

### Certifications :



## TRAX - SWTD12

### Specifications :

Length	1200mm
--------	--------

### Finish Options :



### Certifications :



### Features :

- Solution for height adjustable desks
- Cable tray to workstation umbilical
- Dual Compartment for power and data
- SWTDMAG - Magnet for fixing to steel bases available for additional cost
- Includes tray base fixing, and under desk bracket





## SINGLE TIER CABLE BASKET KIT - SWBK

### Specifications :

Available Widths	<ul style="list-style-type: none"> <li>• 650mm for 900mm Desks</li> <li>• 950mm for 1200mm Desks</li> <li>• 1250mm for 1500mm Desks</li> <li>• 1550mm for 1800mm Desks</li> </ul>
Available Options	<ul style="list-style-type: none"> <li>• 2 x GPO</li> <li>• 4 x GPO</li> </ul>

### Finish Options :



### Features :

- Under desk cable basket kit to organise cables, for power only. Includes basket, power module, gpo clip and interconnecting lead.



## DUAL TIER CABLE BASKET KIT - SWBK

### Specifications :

Available Widths	<ul style="list-style-type: none"> <li>• 650mm for 900mm Desks</li> <li>• 950mm for 1200mm Desks</li> <li>• 1250mm for 1500mm Desks</li> <li>• 1550mm for 1800mm Desks</li> </ul>
Available Options	<ul style="list-style-type: none"> <li>• 2 x GPO with 2 Data tiles</li> <li>• 4 x GPO with 2, 3 or 4 Data</li> </ul>

### Finish Options :

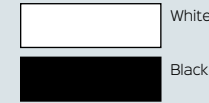

### Features :

- Under desk cable basket kit to organise cables. Includes basket, power module, gpo clip, interconnecting lead and data tile.



## ATHENA POWER RAIL KIT

### Specifications :

SWPR2G	2 x Rotated GPO
SWPR2G2USB	2 x GPO + 2 x USB
SWPR2G2D	2 x GPO + 2 Data Provision
SWPR4G3D	4 x GPO + 3 x Data Provision

### Finish Options :



### Features :

- Includes 500mm Tag Lead D & Splitter
- Clamps onto desk top
- Comes with desk clamps
- Range of configurations to choose from



## BOARDROOM TABLE BOX

### Specifications :

SWTB2G3D	2 x GPO + 3 Data Provision
SWTB4G5D	4 x GPO + 5 x Data Provision

### Finish Options :



### Features :

- Sits in desk or table top
- Lid closes to hide points when not in use
- Leads not included



## POP UP POWER

### Specifications :

SWPOP2G	2 x GPO
SWPOP1G2USB	1 x GPO + 2 x USB

### Finish Options :

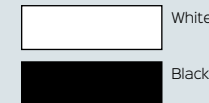

### Features :

- Pop up power module
- Offers above desk power, data and USB
- Can be concealed when not in use
- Leads not included



## IN DESK MODULE

### Specifications :

SWHDP	1 x GPO + 2 x USB + 1 x Data Provision + 500mm TAG lead + 3 way splitter
SWHDP KIT	1 x GPO + 2 x USB + 1 x Data Provision + 500mm TAG lead

### Finish Options :



### Features :

- In desk module
- Offers above desk power, data and USB
- Fits into 80mm cable entry holes



# SMALL MEETING TABLES

## ETERNITY ROUND & SQUARE TABLES

### Specifications :

Round	• D-ERT9 - 900mm Diameter • D-ERT12 - 1200mm Diameter
Square	• D-ERT990 - 900mm W x 900mm D
Height	730mm

### Features :

- Powdercoated base
- Adjustable feet
- 45 degree profile to leg
- E0 Melamine board table top

### Top Options :

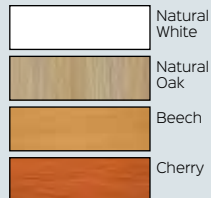

### Base Options :



### Certifications :



## FOUR STAR BASE ROUND TABLE - RSRT | RBRT | RWRT

### Specifications :

Top Diameter	• 900mm
Options	• 1200mm
Table Height	730mm

### Features :

- 4 star base
- Adjustable feet
- E0 Melamine board table top

### Top Options :

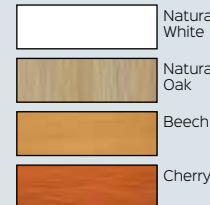

### Base Options :

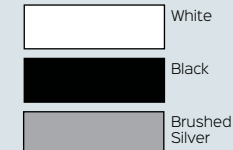

### Certifications :



## TYPHOON ROUND TABLE

### Specifications :

Top Diameter	• TTR9 - 900mm
Options	• TTR12 - 1200mm
Table Height	730mm

### Features :

- 4 star black and polished aluminium base
- Adjustable feet
- E0 Melamine board table top

### Top Options :

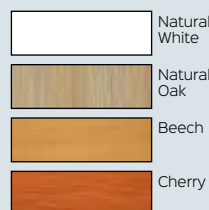

### Base :



### Certifications :



## RAPID AIR ROUND TABLE

### Specifications :

Top Diameter	• RART9 - 900mm
Options	• RART12 - 1200mm
Overall Height	750mm

### Features :

- Modern tripod polished aluminium base
- Matches Rapid Air boardroom range
- E0 Melamine board table top

### Top Options :

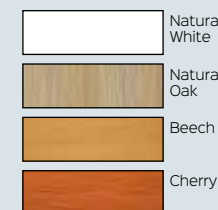

### Base :

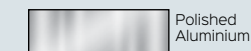

### Certifications :



## DISC BASE TABLE

### Specifications :

Round	• CBT9 - 900mm Dia. • CBT12 - 1200mm Dia.
Square	• CBT990 - 900W x 900D
Height	755mm

### Features :

- Flush flat disc base
- E0 Melamine board table top

### Top Options :



### Base Options :

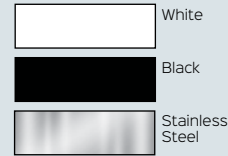

### Certifications :



## IRONSTONE BASE ROUND TABLE

### Specifications :

Top Diameter	• CRM9 - 900mm
Options	• CRM12 - 1200mm
Table Height	730mm

### Features :

- Full E0 Melamine board Top and Base
- Solid melamine ironstone base
- Available in 2 sizes and 2 top finishes
- Matches with Rapid Worker range

### Top Options :

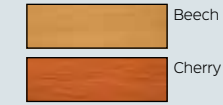

### Certifications :



### Base :

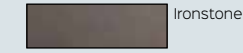

## STEEL FRAME TABLE

### Specifications :

Top Size	• SFT126 - 1200W x 600D
Options	• SFT1575 - 1500W x 750D • SFT1875 - 1800W x 750D • SFT189 - 1800W x 900D
Table Height	730mm

### Features :

- Black steel frame
- Adjustable levelling feet
- E0 Melamine board table top

### Top Options :

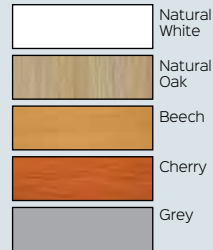

### Base :

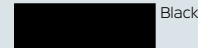

### Certifications :



## SILVER FRAME TABLE

### Specifications :

Top Size	• RST1875 - 1800W x 750D
Options	• RST189 - 1800W x 900D
Table Height	730mm

### Features :

- Stylish angled frame
- Adjustable feet
- E0 Melamine board table top

### Top Options :

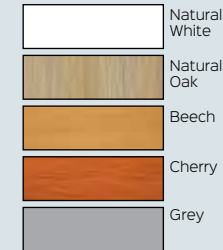

### Base :

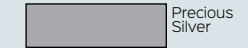

### Certifications :





# CONVERTIBLE TABLES

## TYPHOON FLIP TOP TABLE

### Specifications :

Top Width Options	• TFT1575 - 1500mm • TFT1875 - 1800mm
Top Depth	750mm
Table Height	750mm

### Features :

- Locking castors
- Easy storage when not in use
- Table links available for extra
- E0 Melamine board table top

### Top Options :

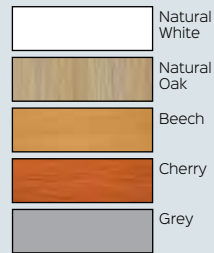

### Base :



### Certifications :



## FOLDING TABLE

### Specifications :

Top Size Options	• FFT1575 - 1500W x 750D • FFT1875 - 1800W x 750D • FFT189 - 1800W x 900D
Table Height	730mm

### Features :

- Adjustable levelling feet
- Suitable for heavy duty use
- Easy storage when not in use
- Easy to use folding mechanism
- E0 Melamine board table top

### Top Options :

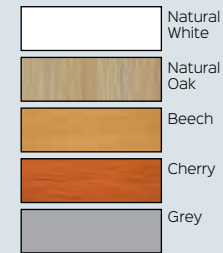

### Base :



### Certifications :



## RAPID EDGE FOLDING TABLE - FBT2410

### Specifications :

Top Width	2400mm
Top Depth	1000mm
Table Height	743mm

### Features :

- Folding table, top folds in half
- Black rubber strip edging
- Quick release mechanism
- Includes 2 x table links

### Top Options :

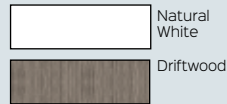

### Base :



### Certifications :



## BUDGET FLIP TOP TABLE

### Specifications :

Top Width Options	• FTT1575 - 1500mm • FTT1875 - 1800mm
Top Depth	750mm
Table Height	730mm

### Features :

- Padded pull handle
- Locking castors
- Table links available for extra
- E0 Melamine board table top

### Top Options :

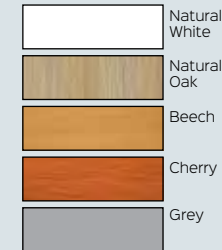

### Base :

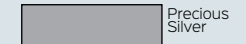

### Certifications :



## DRY BAR TABLE - CDBT6

### Specifications :

Top Size	600mm Diameter
Table Height	1085mm

### Features :

- Circular Dry Bar Table
- Flush flat Disc Base
- E0 Enviroboard Top
- Adjustable Levelling Feet
- Mix and Match top and base colours

### Top Options :



### Base Options :

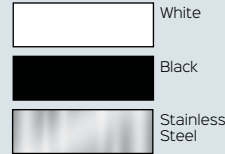

## ETERNITY HIGH BAR TABLE

### Specifications :

Top Size	• D-EHBT1575 - 1500W x 750D
Options	• D-EHBT1875 - 1800W x 750D
	• D-EHBT189 - 1800W x 900D
Table Height	1050mm

### Features :

- Bar height
- Stylish angled leg, matches with Eternity range
- Dual support rails for added stability
- Adjustable feet
- E0 Melamine board table top

### Top Options :

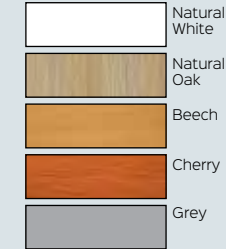

### Base :



## DRAFTING HEIGHT TABLE

### Specifications :

Top Size	• 9SFT1575 - 1500W x 750D
	• 9SFT189 - 1800W x 900D
Table Height	900mm

### Features :

- Drafting height table
- Powdercoated steel frame
- E0 Melamine board table top
- Adjustable feet

### Top Options :

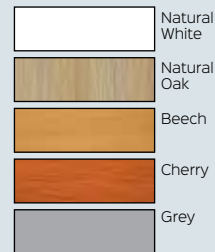

### Base :

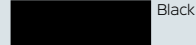

## HIGH BAR TABLE - HBT189

### Specifications :

Top Width	1800mm
Top Depth	900mm
Table Height	1050mm

### Features :

- High bar table
- Powdercoated frame
- Cross bar foot rest
- Adjustable levelling feet
- E0 Melamine board table top

### Top Options :

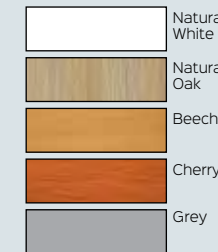

### Base :



# BOARDROOM TABLES

## RAPID AIR BOARDROOM TABLE

### Specifications :

Size	• RAB2412 - 2400W x 1200D
Options	• RAB3212 - 3200W x 1200D
Height	750mm

### Features :

- Suspended floating top
- Available with single or dual stage frame
- 1-Piece Top for 2400mm size
- 2-Piece Top for 3200mm size
- E0 Melamine board table top

### Certifications :



### Top Options :

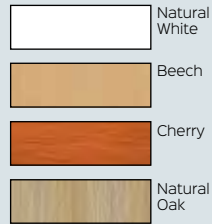

### Base :

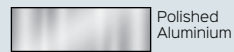

## TYPHOON BOARDROOM TABLE

### Specifications :

Size	• TTR189 - 1800W x 900D
Options	• TTR2412 - 2400W x 1200D
	• TTR3212 - 3200W x 1200D
Height	750mm

### Features :

- Available in 3 sizes
- Single or dual stage frame
- E0 Melamine board table top

### Certifications :



### Top Options :

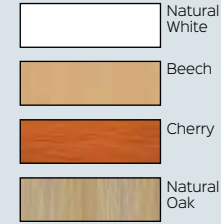

### Base :



## IRONSTONE BASE BOARDROOM TABLE

### Specifications :

Size	• CBT2412 - 2400W x 1200D
Options	• CBT3212 - 3200W x 1200D
Height	730mm

### Features :

- Made entirely of E0 Melamine board
- Sturdy H shape base
- 1-Piece Top for 2400mm size
- 2-Piece Top for 3200mm size

### Certifications :



### Top Options :



### Base :



Rapid Air Boardroom  
Cherry Top  
2400mm x 1200mm



Typhoon Boardroom  
Beech Top  
2400mm x 1200mm



Ironstone Base Boardroom  
Natural Oak Top  
2400mm x 1200mm



Rapid Air Boardroom  
Natural White Top  
3200mm x 1200mm



Typhoon Boardroom  
Natural White Top  
3200mm x 1200mm



Ironstone Base Boardroom  
Natural White Top  
3200mm x 1200mm



## ETERNITY MEETING

### Specifications :

Size Options	<ul style="list-style-type: none"> <li>• EMT1575 - 1500W x 750D</li> <li>• EMT1875 - 1800W x 750D</li> <li>• EMT189 - 1800W x 900D</li> </ul>
Height	750mm

### Features :

- E0 Rated 25mm thick Melamine board
- Double support rails
- Powdercoated base with adjustable feet
- 1-piece top in 3 sizes
- 45 degree profile to leg, matches Eternity workstation range

### Top Options :

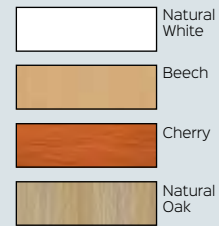

### Base :



### Certifications :



## ETERNITY BOARDROOM

### Specifications :

Size Options	<ul style="list-style-type: none"> <li>• EMT2412 - 2400W x 1200D</li> <li>• EMT3212 - 3200W x 1200D</li> </ul>
Height	750mm

### Features :

- E0 Rated 25mm thick Melamine board
- Double support rails
- Powdercoated base with adjustable feet
- 45 degree profile to leg
- Matches Eternity workstation range
- Intermediate leg in the 3200mm table

### Top Options :



### Base :



### Certifications :



Eternity Meeting Table  
White Top, White Frame  
1500mm x 750mm



Eternity Meeting Table  
Cherry Top, Black Frame  
1800mm x 750mm



Eternity Meeting Table  
Beech Top, White Frame  
1800mm x 900mm



Eternity Boardroom  
Beech Top, Black Frame  
2400mm x 1200mm



Eternity Boardroom  
Natural Oak Top, White Frame  
3200mm x 1200mm

# MESH CHAIRS

## MOTION CHAIR - MMC BG

### Specifications :

Overall Size	960 - 1050H x 650W x 560D
Seat Size	520W x 510D
Gas Height	440 - 530H
Weight Rating	135kg

### Features :

- Donati-dopo weight sensitive mechanism
- Seat slide, lumbar cushion, height adjustable
- 3D adjustable arms
- Head rest available with lead time

### Certifications :



### Finish Options :



## LUMINOUS TASK - LUMINOUS

### Specifications :

Overall Size	960 - 1030H x 625W x 500D
Seat Size	480W x 545D
Gas Height	420 - 510H
Weight Rating	135kg

### Features :

- High back black mesh executive chair
- Synchro mechanism, adjustable arms
- Height adjustable
- Head rest and hanger available with lead time

### Certifications :



### Finish Options :



## ERGO CHAIR - ERGO TASK

### Specifications :

Overall Height	950 - 1040H x 520W x 540D
Seat Size	520W x 490D
Gas Height	450 - 540H
Weight Rating	165kg

### Features :

- Fully ergonomic black mesh back chair
- Seat slide and ratchet back
- Suitable for heavy duty use
- Height adjustable

### Certifications :



### Finish Options :



## GESTURE - GTC BK

### Specifications :

Overall Size	955 - 1045H x 660W x 550D
Seat Size	480W x 520D
Gas Height	450 - 540H
Weight Rating	130kg

### Features :

- Synchro-dynamic mechanism, seat slide
- Synchronised back rest and seat pan tilt
- Adjustable arms and height
- Head rest available with lead time

### Certifications :



### Finish Options :



## ARCO CHAIR - ARCO BL

### Specifications :

Overall Size	900 - 1075H x 720W x 580D
Seat Size	510W x 500D
Gas Height	450 - 540H
Weight Rating	135kg

### Finish :

Black Fabric Seat  
with Black Mesh

NEW

### Features :

- F020S synchronized mechanism with 4 locking positions, seat slider
- Nylon base on castors
- 3D Adjustable arms
- Height Adjustable

### Certifications :



## ORCA CHAIR - ORCA BL

### Specifications :

Overall Size	1030 - 1120H x 730W x 655D
Seat Size	680W x 575D
Gas Height	460 - 550H
Weight Rating	135kg

### Finish :

Black Fabric with  
Black Mesh

NEW

### Features :

- Black 5 star base on castors
- F020S synchronized mechanism with 4 locking positions
- Seat slider & 3D Adjustable arms
- 80mm thick molded foam seat, mesh back

### Certifications :



## OASIS CHAIR - OASIS BL

### Specifications :

Overall Size	1150 - 1220H x 650W x 620D
Seat Size	490W x 515D
Gas Height	470 - 540H
Weight Rating	135kg

### Finish :

Mesh Seat with  
Mesh Back

NEW

### Features :

- Height adjustable
- Nylon base on castors
- Mesh back and Mesh seat for ultimate breathability
- Nylon Armrests and Donati Mechanism

### Certifications :



## HARTLEY CHAIR - HARTLEY TASK

### Specifications :

Overall Height	950 - 1015H x 630W x 500D
Seat Size	500W x 480D
Gas Height	440 - 520H
Weight Rating	110kg

### Features :

- Synchro mechanism with tension control
- Moulded foam seat, black mesh back
- Adjustable arms, adjustable height
- Head rest available with lead time

### Certifications :



### Finish Options :

Black Fabric Seat  
with Black Mesh

Rapidline  
Upholstery Page 69  
House Fabric Seat  
with Black Mesh back



\*Standard  
Black  
Fabric



\*Pictured with  
Spray Fabric,  
Surface textiles  
Yarra range

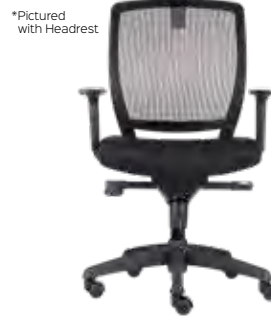

\*Pictured  
with Headrest

## KAL TASK CHAIR - KAL TASK

### Specifications :

Overall Size	970 - 1030H x 650W x 530D
Seat Size	500W x 510D
Gas Height	430 - 520H
Weight Rating	135kg

### Features :

- Lumbar support, synchro mechanism
- Tension control and adjustable arms
- Height adjustable
- Head rest available with lead time

### Certifications :



### Finish Options :

Black Fabric Seat  
with Black Mesh

Rapidline  
Upholstery Page 69  
House Fabric Seat  
with Black Mesh back



\*Standard  
Black Fabric



\*Pictured with  
Spray Fabric,  
Surface textiles  
Yarra range



\*Pictured With  
Headrest



# MESH CHAIRS

## ZOOM CHAIR - ZOOM | ZOOM TABLET

### Specifications :

Overall Size	820H x 625W x 590D
Seat Size	490H x 460W x 490D
*Tablet Overall	20H x 420W x 280D
Weight Rating	110kg

### Features :

- Mesh back with fabric seat
- Foldable, can be nested when not in use
- \*Tablet sold separately
- Seat upholstered in house fabrics for extra

### Finish Options :



Black Fabric



### Certifications :



\*Standard Black, with Tablet arm



\*Pictured with Marine Fabric, Surface textiles Yarra range

## AM100 CHAIR - AM100

### Specifications :

Overall Size	990 - 1080H x 650W x 610D
Seat Size	470W x 490D
Gas Height	460 - 550
Weight Rating	120kg

### Features :

- Seat and Back tilt
- Curved black mesh back, black fabric seat
- Adjustable arms
- Height Adjustable

### Finish :



Black

### Certifications :



## VESTA CHAIR - VESTA

### Specifications :

Overall Size	870 - 970H x 630W x 630D
Seat Size	460W x 460D
Gas Height	430 - 530H
Weight Rating	90kg

### Features :

- Black mesh back chair
- Single Point lock
- Height adjustable
- Fixed arms

### Finish :



Black

### Certifications :



## HARTLEY VISITOR - HARTLEY VISITOR

### Specifications :

Overall Size	950H x 645W x 480D
Seat Size	440H x 510W x 480D
Weight Rating	135kg

### Features :

- Black cantilever frame chair with adjustable arms as standard
- Black mesh back
- Comfortable padded fabric seat that can be upholstered in our Rapidline Upholstery range
- Matches with Hartley Task Chair

### Finish Options :



Black

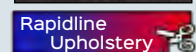

Page 69

### Certifications :



\*Standard Black seat



\*Pictured with Pebble Fabric, Surface textiles Yarra range



\*Standard Black

## VIENNA CHAIR - VIENNA

### Specifications :

Overall Size	980 - 1100H x 610W x 610D
Seat Size	490W x 490D
Gas Height	430 - 550H
Weight Rating	100kg

### Features :

- Mesh back available in a range of bright colours
- Height adjustable chair on a 5 star base with castors
- Tilt lock mechanism
- Fixed loop arms

### Finish Options :

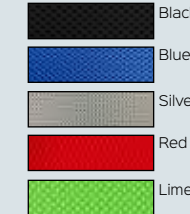

### Certifications :



**VIVA CHAIR - VIVA**

**Specifications :**

Overall Size	775 - 875H x 475W x 460W
Seat Size	455W x 430D
Gas Height	425 - 515H
Weight Rating	110kg

**Finish Options :**  
Black PU / White Frame  
**Rapidline Upholstery** Page 69

**Certifications :**  

**Features :**

- Stylish white polypropylene shell
- Height adjustable
- White base with black castors
- Black PU seat pad - Rapidline Upholstery available



**FOCAL TUB - FOCAL**

**Specifications :**

Overall Size	785H x 570W x 540D
Seat Size	450H x 370W x 380D
Weight Rating	110kg

**Finish :**  
Charcoal Ash Fabric / Black Base

**Certifications :**  

**Features :**

- Polypropylene inner shell with foam overlay
- Fixed height
- Powdercoated 4 star base
- Fabric upholstery



**PIXEL CHAIR - PIXEL**

**Specifications :**

Overall Size	850H x 485W x 600D
Seat Size	430H x 480W x 460D
Weight Rating	110kg

**Finish :**  
Grey Fabric / Black Frame

**Certifications :**  

**Features :**

- Ribbed stitching detail
- Solid timber inner frame with foam overlay
- Fixed height, swivel, 4 star base
- \*Arms available for additional cost



**MILAN CHAIR - MILAN MB BL**

**Specifications :**

Overall Size	1040 - 1105H x 510W x 480W
Seat Size	510W x 480D
Gas Height	490 - 555H
Weight Rating	160kg

**Finish :**  
Black Plastic / Black Fabric

**Certifications :**  
AFRDI 

**Features :**

- Height Adjustable Ratchet Mesh Back
- Fully Ergonomic 4 Lever Mechanism With Seat Slide
- Heavy Duty Base With 50mm Hard Floor Castors
- Luxurious Heavy Duty Moulded Foam Seat



**NEW**

**WM600 CHAIR - WM600**

**Specifications :**

Overall Size	900 - 1020H x 580W x 530D
Seat Size	510W x 420D
Gas Height	480 - 590H
Weight Rating	120kg

**Finish :**  
Black Mesh / Aluminium Base

**Certifications :**  
 SGS

**Features :**

- Ideal meeting chair
- Polished aluminium base and arms
- Single point tilt lock
- Height adjustable



**RE100 CHAIR - RE100**

**Specifications :**

Overall Size	1020 - 1140H x 510W x 500W
Seat Size	510W x 500D
Gas Height	470 - 590H
Weight Rating	110kg

**Finish :**  
Black Plastic / Black Fabric

**Certifications :**  

**Features :**

- Plastic perforated back with fixed arms
- Single point tilt lock
- Height adjustable
- Black base with black castors



# EXECUTIVE CHAIRS

## CL410 CHAIR - CL410

### Specifications :

Overall Size	1190 - 1290H x 650W x 720D
Seat Size	540W x 500D
Gas Height	450 - 550H
Weight Rating	120kg

### Finish :

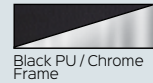

### Certifications :



### Features :

- Soft black PU upholstery with fabric inlay
- Infinite tilt lock, height adjustable
- Fixed curved arm rests
- Chrome base



## CL610 CHAIR - CL610

### Specifications :

Overall Size	1010 - 1140H x 620W x 680D
Seat Size	495W x 500D
Gas Height	450 - 580H
Weight Rating	120kg

### Finish :

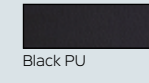

### Certifications :



### Features :

- Soft black PU upholstery
- Single point tilt lock, height adjustable
- Medium back
- Fixed curved arm rests



## CL710 CHAIR - CL710

### Specifications :

Overall Size	1230 - 1320H x 630W x 600D
Seat Size	530W x 530D
Gas Height	460 - 550H
Weight Rating	120kg

### Finish :

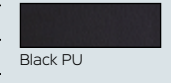

### Certifications :



### Features :

- Soft black PU upholstery
- 4 point tilt lock, height adjustable
- High back executive chair
- Fixed curved armrests



## CL820 CHAIR - CL820

### Specifications :

Overall Size	1180 - 1250H x 670W x 740D
Seat Size	520W x 480D
Gas Height	420 - 490H
Weight Rating	130kg

### Finish :

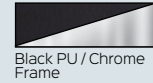

### Certifications :



### Features :

- Soft black PU upholstery
- Infinite tilt lock, height adjustable
- Fixed curved polished aluminium arms
- Chrome base



## PU900 MEDIUM - PU900M

### Specifications :

Overall Size	890 - 960H x 580W x 530D
Seat Size	520W x 435D
Gas Height	460 - 545H
Weight Rating	120kg

### Finish :



### Certifications :



### Features :

- Medium back upholstered in Black PU
- Single point lock, height adjustable
- Polished aluminium base
- Fixed arms



## PU900 HIGH - PU900H

### Specifications :

Overall Size	1050 - 1135H x 585W x 530D
Seat Size	500W x 415D
Gas Height	460 - 550H
Weight Rating	120kg

### Finish :

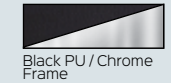

### Certifications :



### Features :

- High back upholstered in Black PU
- Single point lock, height adjustable
- Polished aluminium base
- Fixed arms





## PU300 CHAIR - PU300

### Specifications :

Overall Size	1090 - 1170H x 670W x 640D
Seat Size	540W x 450D
Gas Height	510 - 590H
Weight Rating	130kg

### Finish :



Black PU / Chrome Frame

### Certifications :



### Features :

- Fully ergonomic soft black pu chair
- Ratchet back, seat slide, height adjustable
- Chrome base
- Adjustable arms



## PU605 MEDIUM - PU605M

### Specifications :

Overall Size	980 - 1030H x 580W x 510D
Seat Size	485W x 460D
Gas Height	490 - 610H
Weight Rating	120kg

### Finish Options :



Black PU / Chrome Frame



Tan PU / Black Frame



Black PU / Black Frame

### Features :

- Medium back executive chair
- Infinite lock, height adjustable
- Polished aluminium / powdercoated base



## PU605 HIGH - PU605H

### Specifications :

Overall Size	1105 - 1240H x 580W x 510D
Seat Size	485W x 460D
Gas Height	490 - 610H
Weight Rating	120kg

### Finish :



Black PU / Chrome Frame

### Certifications :



### Features :

- High back black PU executive chair
- Infinite lock, Height adjustable
- Polished aluminium base
- Fixed chrome arms



## CL3000 HIGH BACK - CL3000H

### Specifications :

Overall Size	1200 - 1320H x 620W x 540D
Seat Size	505W x 510D
Gas Height	440 - 560H
Weight Rating	120kg

### Finish :



Black PU / Aluminium Frame

### Certifications :



### Features :

- High back slimline black PU executive chair
- Seat and back tilt, height adjustable
- 3-position lock mechanism with anti shock
- Fixed arm rests



## CL3000 MEDIUM BACK - CL3000M

### Specifications :

Overall Size	1000 - 1130H x 620W x 555D
Seat Size	505W x 510D
Gas Height	440 - 560H
Weight Rating	120kg

### Finish :



Black PU / Aluminium Frame

### Certifications :



### Features :

- Medium back slimline black pu executive chair
- Seat and back tilt, height adjustable
- 3-position lock mechanism with anti shock
- Fixed arm rests



## CL3000 VISITOR - CL3000V

### Specifications :

Overall Size	1000H x 590W x 540D
Seat Size	460H x 510W x 510D
Weight Rating	120kg

### Finish :



Black PU / Aluminium Frame

### Certifications :



### Features :

- Slimline executive visitor chair
- Soft black PU seat and back
- Fixed, chrome upholstered arms
- Cantilever base



# OPERATOR CHAIRS

## ENDEAVOUR CHAIR - ENDEAVOUR PRO BL

### Specifications :

Overall Size	1040 - 1105H x 510W x 480D
Seat Size	510W x 480D
Gas Height	490 - 555H
Weight Rating	160kg

### Finish :

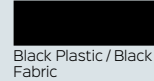

### Features :

- 4 Lever Heavy Duty Mechanism With Seat Slide
- Heavy Duty Base With 50mm Hard Floor Castors
- Triple Strip Lumbar Support
- Luxurious Heavy Duty Moulded Foam Seat

### Certifications :



NEW

## EG400 CHAIR - EG400

### Specifications :

Overall Size	960 - 1080H x 510W x 520D
Seat Size	520W x 480D
Gas Height	480 - 620H
Weight Rating	130kg

### Finish Options :

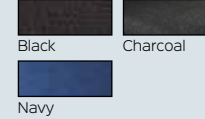

### Features :

- AFRDI level 6
- Fully ergonomic high, square back, fabric chair
- injection moulded foam seat
- Seat and back tilt with gas lift

### Certifications :



## EC070BM CHAIR - EC070BM

### Specifications :

Overall Size	900 - 1030H x 500W x 450D
Seat Size	500W x 450D
Gas Height	470 - 600H
Weight Rating	120kg

### Finish Options :



### Features :

- AFRDI level 6
- Medium back fabric chair
- Back tilt, gas lift
- injection moulded foam seat

### Certifications :



## SWIFT CHAIR - SWIFT BL

### Specifications :

Overall Size	990 - 1090H x 630W x 500D
Seat Size	540W x 450D
Gas Height	510 - 590H
Weight Rating	130kg

### Finish :



### Features :

- High back black fabric chair
- Infinite tilt lock, Height adjustable
- Polished aluminium spider base
- Adjustable arms

### Certifications :



## EC070CH CHAIR - EC070CH

### Specifications :

Overall Size	990 - 1120H x 500W x 450D
Seat Size	500W x 450D
Gas Height	470 - 600H
Weight Rating	120kg

### Finish Options :

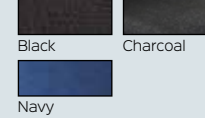

### Features :

- Fully ergonomic high back fabric chair
- injection moulded foam seat
- Seat and back tilt with gas lift

### Certifications :



## EC070BH CHAIR - EC070BH

### Specifications :

Overall Size	990 - 1120H x 500W x 450D
Seat Size	500W x 450D
Gas Height	470 - 600H
Weight Rating	120kg

### Finish Options :

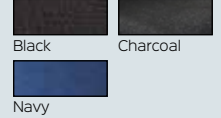

### Features :

- High back chair
- Gas lift, back tilt
- Injection moulded foam

### Certifications :



## EC070CM CHAIR - EC070CM

### Specifications :

Overall Size	900 - 1030H x 500W x 450D
Seat Size	500W x 450D
Gas Height	470 - 600H
Weight Rating	120kg

### Features :

- AFRDI level 6
- Fully ergonomic medium back fabric chair
- injection moulded foam seat
- Seat and back tilt with gas lift

### Certifications :



### Finish Options :

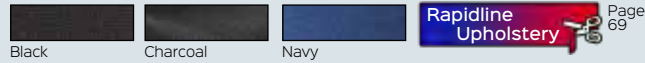

## EG100CH CHAIR - EG100CH

### Specifications :

Overall Size	1010 - 1150H x 520W x 480D
Seat Size	520W x 480D
Gas Height	480 - 620H
Weight Rating	130kg

### Features :

- AFRDI level 6
- Fully ergonomic high back fabric chair
- injection moulded foam seat
- Seat and back tilt with gas lift

### Certifications :



### Finish Options :

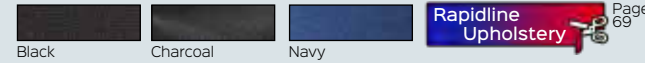

## EM300 CHAIR - EM300

### Specifications :

Overall Size	920 - 1050H x 480W x 525D
Seat Size	490W x 440D
Gas Height	460 - 590H
Weight Rating	110kg

### Features :

- Fully ergonomic, height adjustable
- Seat available in fabric or PU
- Mesh back with Injection moulded foam seat
- Arms, Chrome base and Drafting kit available for extra

### Certifications :



### Finish Options :

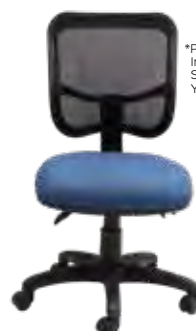
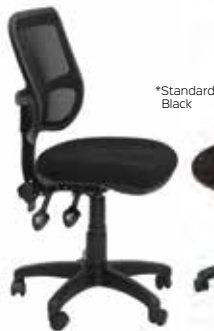

## PO500 CHAIR - PO500

### Specifications :

Overall Size	1020 - 1150H x 550W x 570D
Seat Size	530W x 510D
Gas Height	490 - 590H
Weight Rating	150kg

### Features :

- AFRDI level 6, heavy duty mechanism
- Fully ergonomic high back fabric chair
- injection moulded foam, extra large seat
- Seat and back tilt with gas lift

### Certifications :



### Finish Options :





# OPERATOR CHAIRS & ACCESSORIES

## ET20 CHAIR - ET20

### Specifications :

Overall Size	830 - 940H x 480W x 460D
Seat Size	480W x 460D
Gas Height	420 - 530H
Weight Rating	100kg

### Finish :

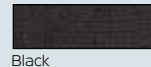

Black

### Certifications :



### Features :

- Black fabric medium back chair
- Gas lift, back and seat tilt
- Injection moulded foam



## CHAIR ACCESSORIES

The Adjustable arm, Chrome base and Drafting kit accessories are compatible with :

- EC070CM
- EG100CH
- EM300
- EG400
- PO500
- EC070BM
- EC070CH
- EC070BH
- ET20

## ADJUSTABLE ARMS - ADJ ARMS

### Specifications :

Overall Height	250mm - 320mm
Overall Width	230mm
Overall Depth	260mm
Arm Pad Width	85mm
Arm Pad Depth	260mm

### Finish :

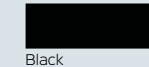

Black

### Certifications :



### Features :

- Adjustable height
- Simple assembly



## EC070BM DRAFTING - EC070BM DRAFTING

### Specifications :

Overall Size	1060 - 1230H x 500W x 450D
Seat Size	500W x 450D
Gas Height	630 - 800H
Weight Rating	120kg

### Finish :

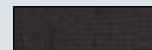

Black

### Certifications :



### Features :

- Medium back drafting chair
- Back tilt, gas lift
- Injection moulded foam



\*Black



\*With add-on arms

## CHROME BASE - CH BASE

### Specifications :

Overall Height	150mm
Diameter	650mm

### Finish :

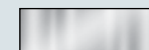

Chrome

### Certifications :



### Features :

- Quick and easy way to upstyle your chair
- Stylish and up market look
- Polished Aluminium
- Castors not included



\*Pictured with castors

## DRAFTNG KIT - DRAFTNG KIT

### Specifications :

Overall Height	150mm
Diameter	650mm

### Finish :



Chrome / Black

### Certifications :



### Features :

- Used to create a drafting height chair
- Adds height to your operator chair
- Includes foot ring for resting
- Use with drafting height table or height adjustable desk



## DS DESK STOOL - DS DESK

### Specifications :

Overall Size	450 - 570H x 600 Diameter
Seat Size	450 - 570H x 400 Diameter
Weight Rating	100kg

### Finish :

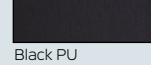

Black PU

### Features :

- 400mm round seat desk stool
- Easy to clean black PU material
- Black spider base
- Height adjustable

### Certifications :



## LAB CHAIR - LAB CH

### Specifications :

Overall Size	845 - 960H x 470W x 430D
Seat Size	420 - 540H x 470W x 435D
Weight Rating	110kg

### Finish :

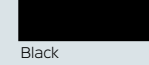

Black

### Features :

- Height adjustable Laboratory chair
- Moulded polyurethane
- Contoured waterfall seat pan
- Seat and back tilt

### Certifications :



## YOYO CHAIR

### Specifications :

Overall Size	730-820H x 600W x 600D
Seat Size	420-510H x 450W x 440D
Weight Rating	110kg

### Finish :



Dark Grey fabric / Black frame

### Features :

- Height adjustable swivel chair
- Moulded foam seat and back
- Nylon base with castors
- Wire-control mechanism

### Certifications :



## DS COUNTER STOOL - DS COUNTER

### Specifications :

Overall Size	650 - 870H x 600 Diameter
Seat Size	650 - 870H x 400 Diameter
Weight Rating	100kg

### Finish :



Black PU / Chrome

### Features :

- 400mm round seat counter stool
- Chrome drafting ring
- Easy to clean Black PU material
- Black spider base

### Certifications :



## LAB STOOL - LAB ST

### Specifications :

Overall Size	965 - 1185H x 470W x 500D
Seat Size	640 - 850H x 460W x 440D
Weight Rating	110kg

### Finish :



Black / Chrome

### Features :

- Moulded polyurethane
- Contoured waterfall seat pan
- Tilting back rest with infinite lock
- Height adjustable, chrome drafting ring

### Certifications :



## YOYO STOOL

### Specifications :

Overall Size	820 - 1020H x 600W x 600D
Seat Size	520 - 720H x 450W x 440D
Weight Rating	110kg

### Finish :



Dark Grey fabric / Black frame

### Features :

- Height adjustable sit-stand chair
- Moulded foam seat and back
- Nylon base with castors and footing
- Wire-control mechanism

### Certifications :



# BREAKOUT AND VISITOR CHAIRS

## WMVBK CHAIR - WMVBK

### Specifications :

Overall Size	890H x 570W x 460D
Seat Size	480H x 480W x 480D
Weight Rating	120kg

### Finish Options :



### Features :

- Mesh back and fabric seat
- Chrome frame and legs
- Curved plastic arm rests
- Seat can be upholstered in house fabrics

### Certifications :



## WMCC CHAIR - WMCC

### Specifications :

Overall Size	940H x 625W x 620D
Seat Size	440H x 470W x 470D
Weight Rating	120kg

### Finish Options :



### Features :

- Cantilever chrome base
- Comfortable mesh material on back
- Fixed Arms
- Fabric seat

### Certifications :



## WFV100 CHAIR - WFV100 BL

### Specifications :

Overall Size	930H x 570W x 580D
Seat Size	475H x 450W x 435D
Weight Rating	120kg

### Finish :



### Features :

- Comfortable black fabric chair
- Chrome sled base
- Modern and stylish design
- Linkable bases

### Certifications :



## V100 CHAIR - V100

### Specifications :

Overall Size	800H x 500W x 450D
Seat Size	460H x 450W x 450D
Weight Rating	120kg

### Finish :



### Features :

- Comfortable black fabric
- Black frame
- Stackable

### Certifications :



## NOVA CHAIR - NOVA

### Specifications :

Overall Size	780H x 540W x 460D
Seat Size	445H x 448W x 444D
Weight Rating	110kg

### Finish Options :



### Features :

- Stackable
- Linkable
- Fabric seat and back
- Black powdercoated frame



## P100 CHAIR - P100

### Specifications :

Overall Size	845H x 450W x 370D
Seat Size	440H x 450W x 370D
Weight Rating	130kg

### Finish :

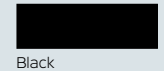

### Features :

- Polypropylene plastic chair
- Stackable
- Sturdy frame
- Ventilation hole in back

### Certifications :





## FRAME CHAIR - FRAME BL

### Specifications :

Overall Size	790H x 470W x 500D
Seat Size	455H x 420W x 410D
Weight Rating	120kg

### Finish :

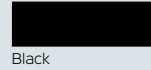

Black

### Features :

- Perforated back rest and polypropylene seat
- Stackable with linking feature
- Solid rod base
- SGS: EN12520 Certification

### Certifications :



## VIVID CHAIR - VIVID

### Specifications :

Overall Size	820H x 455W x 510D
Seat Size	460H x 455W x 470D
Weight Rating	120kg

### Finishes :



Black

White

### Features :

- Large polypropylene shell seat
- Powdercoated steel sled base
- Nylon glides under frame
- Stackable

### Certifications :



## PMVBK CHAIR - PMV- BK

### Specifications :

Overall Size	810H x 530W x 460D
Seat Size	450H x 455W x 460D
Weight Rating	110kg

### Finish :



Black / Chrome

### Features :

- Black mesh back chair
- Plastic seat
- Stackable with linking feature
- Chrome sled base and frame

### Certifications :



## TEMPO CHAIR - TEMPO

### Specifications :

Overall Size	820H x 550W x 570D
Seat Size	420H x 480W x 420D
Weight Rating	110kg

### Finishes :



Charcoal / Black

Black / White

### Features :

- Fabric Seat
- Powdercoat sled base
- Linking
- Stackable

### Certifications :



Black PU / Black



NEW

Black PU / Black

## ZING CHAIR - ZING

### Specifications :

Overall Size	810H x 465W x 430D
Seat Size	440H x 465W x 430D
Weight Rating	120kg

### Finish Options :



Black / Chrome



Page 69

### Features :

- Large plastic back and seat
- Linkable and Stackable
- Chrome sled base with feet
- Seat and back pads available in Rapidline upholstery colours for extra

### Certifications :



## PIPPEE CHAIR - PIPPEE

### Specifications :

Overall Size	860H x 400W x 380D
Seat Size	450H x 400W x 380D
Weight Rating	150kg

### Finish Options :



Black

Grey

Green

### Features :

- Polypropylene plastic
- Stackable
- High luster shine
- Holds up to 150kg under intended use

### Certifications :



# BREAKOUT AND VISITOR CHAIRS

## MAUI CHAIR - MAUI GB

### Specifications :

Overall Size	840H x 530W x 460D
Seat Size	450H x 465W x 450D
Weight Rating	135kg

### Finishes :

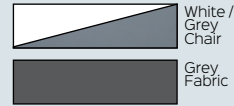

### Features :

- Polypropylene chair
- White and Slate-Grey frame
- Grey fabric seat cover included
- Made from 100% recyclable materials

### Certifications :



## LUCID CHAIR - LUCID

### Specifications :

Overall Size	795H x 500W x 500D
Seat Size	450H x 440W x 400D
Weight Rating	110kg

### Seat Finishes :

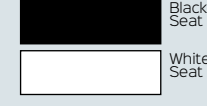

### Features :

- Concealed Feet Buttons
- Polypropylene Chair
- Textured Seat and back
- Mix and Match seats and bases

### Certifications :



### Leg Finishes :



## VIRGO CHAIR - VIRGO

### Specifications :

Overall Size	825H x 440W x 440D
Seat Size	470H x 440W x 440D
Weight Rating	110kg

### Finish Options :



### Features :

- Timber leg
- Polypropylene shell
- Comfortable fabric seat pad

### Certifications :



## COMFO CHAIR - COMFO

### Specifications :

Overall Size	970H x 570W x 600D
Seat Size	460H x 510W x 490D
Weight Rating	110kg

### Finish :



### Features :

- Black PU seat and back
- Chrome cantilever base
- Padded curved arm rests

### Certifications :



## LEO CHAIR - LEO

### Specifications :

Overall Size	830H x 460W x 410D
Seat Size	450H x 420W x 410D
Weight Rating	100kg

### Finish Options :

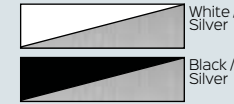

### Features :

- Plastic hospitality chair
- Suitable for indoor or outdoor use
- Aluminium legs

### Certifications :



## FERNANDO CHAIR - FERNANDO

### Specifications :

Overall Size	920H x 425W x 420D
Seat Size	440H x 425W x 420D
Weight Rating	90kg

### Finish :



### Features :

- Stylish black PU seat and back
- Chrome frame
- Cut out feature in back of chair
- Stackable

### Certifications :



**WIMBLEDON CHAIR - WIMBLEDON**

**Specifications :**



Overall Size	785H x 435W x 460D
Seat Size	440H x 400W x 430D
Weight Rating	120kg

**Finish :**  Black / Chrome

**Features :**

- Plastic seat and back
- Chrome sled base
- Linkable and Stackable
- SGS: EN12520 Certification

**Certifications :**

**WIMBLEDON WITH ARMS - WIMBLEDON WITH ARMS**

**Specifications :**

Arms	205H x 30W x 285D
Weight Rating	120kg

**Finish :**  Black / Chrome

**Features :**

- Plastic seat and back with arms
- Chrome sled base
- Linkable
- Stackable

**Certifications :**



**WIMBLEDON TABLET - WTAB**

**Specifications :**

Tablet	255W x 400D
Height from seat	215mm

**Finish :**  Black / Chrome

**Features :**

- Plastic seat and back
- Chrome sled base
- Foldable Tablet

**Certifications :**



**WIMBLEDON PADS - WSP | WBP**

**Specifications :**

Seat Size	440H x 425W x 430D
Back Size	245H x 455W
Weight Rating	120kg

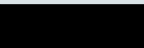
**Finish Options :**  Black Fabric

**Features :**

- Stocked in black fabric
- Can be upholstered in Rapidline fabrics
- Seat pad - WSP sold separately
- Back pad - WBP sold separately

**Certifications :**



**Rapidline Upholstery**  Page 69

**ZOLA CHAIR - ZOLA**

**Specifications :**

Overall Size	800H x 460W x 500D
Seat Size	430H x 460W x 440D
Weight Rating	100kg

**Finish :**  Black / Chrome

**Features :**

- Black plastic seat
- Curved back
- Chrome frame with sled base
- Stackable

**Certifications :**



**CHAIR TROLLEY - Z TROLLEY**

**Specifications :**

Overall Size	440 H x 800W x 620 D
Weight Rating	Maximum of 30 chairs
Compatible with	<ul style="list-style-type: none"> <li>• PMVBK</li> <li>• FRAME BL</li> <li>• ZING</li> <li>• ZOLA</li> <li>• WIMBLEDON</li> </ul>

**Finish :**  Black

**Certifications :**





# BREAKOUT CHAIRS & STOOLS, CUSHIONS

## TAURUS CHAIR - TAURUS

### Specifications :

Overall Size	735H x 540W x 460D
Seat Size	440H x 440W x 435D
Weight Rating	110kg

### Finish Options :



Black / Chrome

### Features :

- Chrome frame and legs
- Wrap around polypropylene shell
- Cut out feature on back
- Stackable

### Certifications :



## VIRGO BAR STOOL - VIRGO ST

### Specifications :

Overall Size	820H x 475W x 475D
Seat Size	770H x 440W x 450D
Weight Rating	110kg

### Finish Options :



Black / Timber



Grey / Timber



Green / Timber

### Features :

- Modern bar stool
- Oak coloured frame
- Curved polypropylene plastic seat pan



## CAD Cushion

### Specifications :

Overall Width	460mm
Overall Depth	460mm
Overall Height	40mm
Overall height of Caddy with cushion	610mm

### Finish Options :

Rapidline Upholstery Page 69

- Choose from any fabric in any of our partnered ranges on page 69

### Features :

- Fabric seat Cushion. \*Caddy not included



## TAURUS BAR STOOL - TAURUS STOOL

### Specifications :

Overall Size	1050H x 525W x 460D
Seat Size	750H x 435W x 455D
Weight Rating	110kg

### Finish Options :



Black / Chrome

### Features :

- Chrome frame and legs
- Wrap around polypropylene shell
- Cut out feature on back
- Leg rest on chrome base / frame

### Certifications :



## ARIES BAR STOOL - ARIES ST

### Specifications :

Overall Size	853H x 455W x 545D
Seat Size	760H x 440W x 450D
Weight Rating	110kg

### Finish Options :



Black / Black



Grey / Black



Green / Black

### Features :

- Stylish black metal curved frame
- Polypropylene plastic seat pan
- Leg rest on base / frame



## GMP3 Cushion

### Specifications :

Overall Width	460mm
Overall Depth	475mm
Overall Thickness	40mm
Overall height of GMP3 with cushion	660mm

### Finish Options :

Rapidline Upholstery Page 69

- Choose from any fabric in any of our partnered ranges on page 69

### Features :

- Fabric seat Cushion. \*Mobile Ped not included



## Chair and Screen Upholstery

For a wider colour selection than our standard express range, we can upholster certain products in a range of extended Rapidline Upholstery fabrics, or \*your fabric of choice.

### UPHOLSTERY CHAIRS :

- EM300
- EC070CM
- EG100
- PO500
- MOTION
- GESTURE
- LUMINOUS
- ERGO
- HARTLEY TASK
- HARTLEY VISITOR
- KAL
- ZOOM
- WMCC
- WMVBK
- WIMBLEDON (Back and Seat Pad)
- VIVA chair (Seat Pad)
- CONNECT OTTOMAN
- MARS OTTOMANS
- ZING (Back and Seat Pad)
- GMP3 Cushion
- CAD Cushion



**laine™**  
Suzette

INSTYLE  
THINK PLUS

WORTLEY  
Furnishing in Style  
ACCESS

sustainable  
living  
FABRICS  
RENEGADE

surface  
TEXTILES  
Yarra

rim  
Fabrics  
design • technology • sustainability  
Sensation Woven

### UPHOLSTERY SCREENS :

- SHUSH30+ Screens
- RAPID Screens  
(Fabric Top Half of Screen Panel)
- Freestanding Acoustic Screens
- Infinity, Eternity & BOOST+ Screens

WARWICK  
Ashcroft

WARWICK  
Beachcomber

WARWICK  
LUSTRELL CHARISMA

\*Lead Times and Additional Charges Apply\*  
\*Option to supply your own fabric

## GLASSBOARD

### Specifications :

Size Options	<ul style="list-style-type: none"> <li>• GB96 - 900mm W x 600mm H</li> <li>• GB129 - 1200mm W x 900mm H</li> <li>• GB159 - 1500mm W x 900mm H</li> <li>• GB1512 - 1500mm W x 1200mm H</li> <li>• GB189 - 1800mm W x 900mm H</li> <li>• GB1812 - 1800mm W x 1200mm H</li> <li>• GB2112 - 2100mm W x 1200mm H</li> <li>• GB2412 - 2400mm W x 1200mm H</li> </ul>
Overall Depth	15mm

### Features :

- Compatible with any whiteboard markers or liquid chalk markers (not included)
- Super clear 4mm toughened glassboard
- Magnetic surface - Requires super strong magnets
- Galvanised steel backing
- 25mm chrome fittings

### Finish :

	White
---	-------



## LECTERN - LCT12 BL

### Specifications :

Overall Size	1200H x 445W x 450D
Top Shelf Size	600W x 400D
Second Shelf Size	550W x 260D

### Features :

- Heavy duty lectern
- Angled top shelf for presentations
- Second shelf for storage
- Black powdercoated finish
- Detachable adjustable battery powered LED light
- Castors

### Finish :

	Black
---	-------

### Certifications :



## PINBOARD



### Specifications :

Size Options	<ul style="list-style-type: none"> <li>• PIN96 - 900mm W x 600mm H</li> <li>• PIN129 - 1200mm W x 900mm H</li> <li>• PIN1212 - 1200mm W x 1200mm H</li> <li>• PIN159 - 1500mm W x 900mm H</li> <li>• PIN1512 - 1500mm W x 1200mm H</li> <li>• PIN189 - 1800mm W x 900mm H</li> <li>• PIN1812 - 1800mm W x 1200mm H</li> <li>• PIN2412 - 2400mm W x 1200mm H</li> </ul>
Overall Depth	15mm

### Features :

- Wall mounted pinboard
- Concealed corner wall fixings
- Felt surface
- Includes 4 Pins
- Galvanised steel backing
- Low density fibreboard core

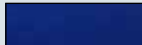
### Finish :

	Blue
	Grey



## CORKBOARD

### Specifications :

Board Size Options	<ul style="list-style-type: none"> <li>• C96 - 900W x 600H</li> <li>• C129 - 1200W x 900H</li> <li>• C1212 - 1200W x 1200H</li> <li>• C159 - 1500W x 900H</li> <li>• C1512 - 1500W x 1200H</li> <li>• C189 - 1800W x 900H</li> <li>• C1812 - 1800W x 1200H</li> <li>• C2412 - 2400W x 1200H</li> </ul>
Overall Depth	15mm

### Features :

- Composite corkboard aluminium frame
- Concealed corner wall fixings
- Suitable for pins or stickers

### Finish :

	Corkboard
---	-----------





# PRESENTATION RANGE

## WHITEBOARD

### Specifications :

Size	• W96 - 900H x 600W	• W129 - 1200H x 900W
Options	• W1212 - 1200H x 1200W	• W159 - 1500H x 900W
	• W1512 - 1500H x 1200W	• W189 - 1800H x 900W
	• W1812 - 1800H x 1200W	• W219 - 2100H x 900W
	• W2112 - 2100H x 1200W	• W2412 - 2400H x 1200W
Overall Depth	15mm	

### Features :

- Wall mounted aluminium frame
- Magnetic surface
- Pen tray included
- Concealed corner fixing
- Acrylic polyester resin
- Includes fixing screws

### Finish :



White



## PORCELAIN WHITEBOARD

### Specifications :

Size	• PWB96 - 900H x 600W	• PWB129 - 1200H x 900W
Options	• PWB1212 - 1200H x 1200W	• PWB159 - 1500H x 900W
	• PWB1512 - 1500H x 1200W	• PWB189 - 1800H x 900W
	• PWB1812 - 1800H x 1200W	• PWB2112 - 2100H x 1200W
	• PWB2412 - 2400H x 1200W	• PWB3012 - 3000H x 1200W
Overall Depth	15mm	

### Features :

- Porcelain / Vitreous enamel surface (Polyvision E3 ceramic steel)
- Includes 4 x Magnets
- Includes fixing screws
- Includes pen tray

### Finish :



White



## MOBILE WHITEBOARD

### Options :

MW129	1200mm W x 900mm H
MW159	1500mm W x 900mm H
MW1512	1500mm W x 1200mm H
MW189	1800mm W x 900mm H
MW1812	1800mm W x 1200mm H

### Specifications :

Overall Height	1770mm
Overall Depth	550mm

### Features :

- Mobile whiteboard with castors
- Includes pen tray
- Double sided
- Pivoting

### Finish :



White



## MOBILE PORCELAIN WHITEBOARD

### Options :

PMW129	1200mm W x 900mm H
PMW1512	1500mm W x 1200mm H
PMW1812	1800mm W x 1200mm H

### Specifications :

Overall Height	1770mm
Overall Depth	550mm

### Features :

- Mobile whiteboard with castors
- Pivoting
- Double sided
- Porcelain / Vitreous enamel surface (Polyvision E3 ceramic steel)
- Includes pen tray

### Finish :



White



# DESK MOUNTED SCREENS

## NEW ECO PANEL SCREENS

### Dimensions :

Width	EPS750 - 740mm
Options	EPS1200 - 1190mm EPS1500 - 1490mm EPS1800 - 1790mm
Finished Height (with clamps)	400mm
Screen Height	384mm
Thickness	27mm

### Features :

- Polyester fibre panel pinnable surface
- Radial corners
- \*Requires additional Fixings. See below ECO Panel Clamps\*
- \*Clamps not included\*

### Finish Options :

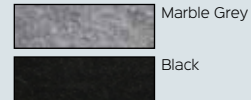

NEW



\* EPS1500 BK

## SLIDE ON SCREEN - SEPS70

### Dimensions :

Overall Width	820mm
Overall Height	530mm
Thickness	27mm
Height from desk to cavity	400mm
Length from cavity to edge	700mm
Cavity Height	24mm
Corner Radius	40 Degrees

### Features :

- Polyester fibre panel pinnable surface
- Suits 25mm Thick tops
- Requires no Fixings

### Finish Options :

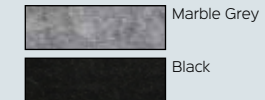

NEW



## ECO PANEL CLAMPS

### Specifications :

EPSCLAMP	Desk mounted clamp. Use for most workstations
EPSMC	Side mounted clamp. Use for Single workstations
BTBEPSC	Back to Back mounete. Use for Back to back workstations

### Finish Options :

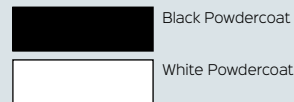

### Features :

- Used for mounting ECO Panel Screens with a thickness of 16mm - 31mm
- Powdercoated clamps come in a set of 2
- Side and Back to Back versions screw in from bottom of desk



NEW

\* Pictured below: EPS1500 MG screen with EPSCLAMPS WS



\* EPSCLAMP



\* EPSMC



\* BTBEPSC

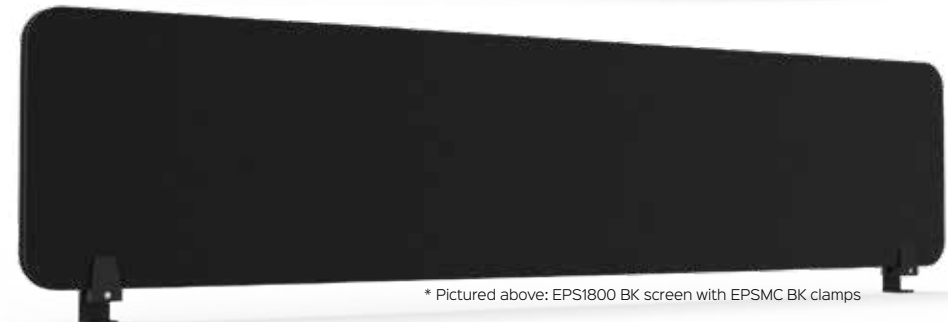

\* Pictured above: EPS1800 BK screen with EPSMC BK clamps

## 1800mm HEIGHT ACOUSTIC SCREEN

### Specifications :

Width	• A1518 - 1500mm
Options	• A1818 - 1800mm
Height	1800mm
Thickness	50mm

### Features :

- Free standing dividing office panels
- Pinnable fabric with black pvc edging
- Silver freestanding feet

### Finish Options :

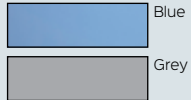

### Certifications :



## 1500mm HEIGHT ACOUSTIC SCREEN

### Specifications :

Width	• A1515 - 1500mm
Options	• A1815 - 1800mm
Height	1500mm
Thickness	50mm

### Features :

- Free standing dividing office panels
- Pinnable fabric with black pvc edging
- Silver freestanding feet

### Finish Options :

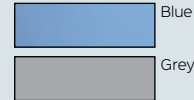

### Certifications :





# PERSONAL STORAGE

## GO STEEL MOBILE PEDESTAL - GMP3

### Specifications :

Overall Width	460mm
Overall Depth	472mm
Overall Height	610mm
Top Drawer Size	390W x 475D x 65H
Filing Drawer Size	390W x 475D x 250H
Weight Rating	30kgs per Drawer

### Finishes :

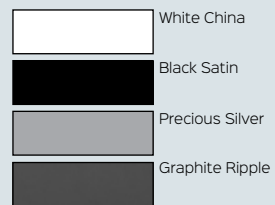

### Features :

- For larger workstations
- Lockable - Supplied with 2 keys
- Stores foolscap files back to front
- Flush drawer front
- Full extension ball bearing runners
- Fifth wheel for stability
- Keyed alike locks available for extra

### Certifications :



## GO STEEL SLIMLINE MOBILE PED - GSP3

### Specifications :

Overall Width	300mm
Overall Depth	472mm
Overall Height	610mm
Top Drawer Size	230W x 460D x 65H
Filing Drawer Size	230W x 460D x 250H
Weight Rating	30kgs per Drawer

### Finishes :



### Features :

- Slimline for smaller workstations
- Lockable - Supplied with 2 keys
- Stores foolscap files side to side
- Flush drawer front
- Ball bearing runners
- Fifth wheel for stability
- Keyed alike locks available for extra

### Certifications :



## ETERNITY SLIMLINE MOBILE PED - EMP3 WB

### Specifications :

Overall Width	300mm
Overall Depth	535mm
Overall Height	580mm
Top Drawer Size	240W x 500D x 70H
Filing Drawer Size	240W x 500D x 250H
Weight Rating	30kgs per Drawer

### Finishes :



### Features :

- Stylish curved corners
- Slimline for smaller workstations
- Powdercoated steel mobile pedestal
- 2 personal drawers and 1 file drawer
- Fifth wheel for stability and anti-tilt
- Lockable - Supplied with 2 keys

### Certifications :



\*Graphite Ripple



\*Precious Silver



## GO STEEL MOBILE CADDY - GCADN

### Specifications :

Overall Size	618H x 1050W x 500D
Tambour (internal)	500H x 560W x 470D
Top 2 drawers (internal size)	70H x 320W x 460D
Bottom filing drawer (internal)	240H x 320W x 460D

### Finishes :

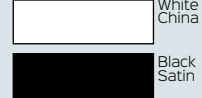

### Certifications :



### Features :

- On castors, with 5th Wheel On File Drawer
- Lockable pedestal and tambour door with 2 keys supplied
- 2 drawers and 1 file drawer, files run front to back
- Tambour section with adjustable shelf
- GCADN-L - Tambour door on left hand side
- GCADN-R - Tambour door on right hand side
- Seat pad available for additional extra

## GO STEEL FILING CABINET

### Specifications :

Width	460mm
Depth	620mm
Drawer Options	<ul style="list-style-type: none"> <li>• GFCA2 - 2 drawer, 705mm H</li> <li>• GFCA3 - 3 drawer - 1016mm H</li> <li>• GFCA4 - 4 drawer - 1321mm H</li> </ul>

### Finishes :

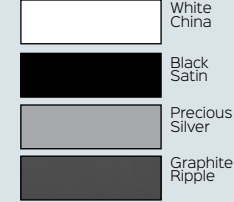

### Certifications :



### Features :

- Lockable - Supplied with 2 keys
- Heavy duty and Fully riveted
- Ball bearing runners
- 40kg weight capacity per drawer

## GO STEEL LATERAL FILING CABINET

### Specifications :

Width	900mm
Depth	473mm
Height	<ul style="list-style-type: none"> <li>• GLF2 - 2 drawer - 705mm</li> <li>• GLF3 - 3 drawer - 1016mm</li> <li>• GLF4 - 4 drawer - 1321mm</li> </ul>

### Finishes :

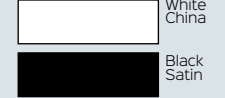

### Certifications :



### Features :

- Lockable - Supplied with 2 keys
- Riveted construction for extra strength
- Heavy duty and Anti-tilt
- 2 rows of folders per drawer



\*Graphite Ripple



\*Silver Grey



\*White China



\*Black Ripple



# TAMBOUR DOORS

## 900mm Wide TAMBOUR DOOR CUPBOARD

### Specifications :

Height Options	<ul style="list-style-type: none"> <li>GTD109 - 1016mm</li> <li>GTD129 - 1200mm</li> <li>GTD199 - 1981mm</li> </ul>
Depth	473mm
Width	900mm

### Features :

- Easy glide track
- Magnetic anti slam rail keeps doors closed
- Fully riveted for extra strength
- 40kg weight rating per shelf
- Fully Lockable with 2 keys supplies (master series)
- Adjustable feet for leveling
- Tambour door cupboard unit only, shelves sold separately
- Optional extra shelves and range of accessories available

### Finishes :



### Certifications :



## 1200mm Wide TAMBOUR DOOR CUPBOARD

### Specifications :

Height Options	<ul style="list-style-type: none"> <li>GTD1012 - 1016mm</li> <li>GTD1212 - 1200mm</li> <li>GTD1912 - 1981mm</li> </ul>
Depth	473mm
Width	1200mm

### Features :

- Easy glide track
- Magnetic anti slam rail keeps doors closed
- Fully riveted for extra strength
- 40kg weight rating per shelf
- Fully Lockable with 2 keys supplies (master series)
- Adjustable feet for leveling
- Tambour door cupboard unit only, shelves sold separately
- Optional extra shelves and range of accessories available

### Finishes :

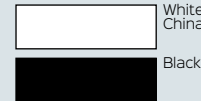

### Certifications :



Pictured Left : GTD199 WC  
White China, 1981mm H x 900mm W

Top shelf is a Slotted shelf with dividers  
Middle shelf is a standard plain shelf  
Bottom shelf is a Pull out filing frame  
\*\*Standard tambour does not come with add-on shelving and accessories

Pictured Below: GTD129 BL  
Black, 1200H x 900W

\*\*Standard tambour does not come with add-on shelves



Pictured Left : GTD1912 WC  
White China, 1981mm H x 1200mm W

Pictured bottom shelf is a Pull out filing frame  
\*\*Standard tambour does not come with add-on shelving and accessories

Pictured Below: GTD1012 WC  
White, 1016mm H x 1200mm W

\*\*Standard tambour does not come with add-on shelves





### PLANTER BOX

**Specifications :**

Width	• PB900 - Suits 900mm W unit
Options	• PB1200 - Suits 1200mm W unit
Size	230mm H x 473mm D

**Finishes :**

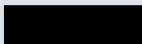
	White China
	Black

**Features :**

- Space for 3 x 200mm plant pots (**plants and pots not included**)
- Incorporated drip tray
- Use on top of tambour door cupboards or lateral filing cabinets

**Certifications :**





### PLAIN SHELF

**Specifications :**

Width	• GTD900 - Suits 900mm W unit
Options	• GTD1200 - Suits 1200mm W unit
Size	470mm D x 30mm T

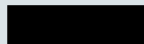
**Finishes :**

	White China
	Black

**Features :**

- Standard shelf to use with Tambour door cupboards
- Easy to install - Clips supplied
- Easy to adjust to different heights

**Certifications :**





### PULL OUT SHELF

**Specifications :**

Width	GG09PS - Suits 900mm W unit
Options	GG12PS - Suits 1200mm W unit
Size	470mm D x 30mm T

**Finishes :**

	White China
---	-------------

**Features :**

- Pull out shelf for use in tambour door cupboard units
- Shelf slides out for easy operation to find or work on files

**Certifications :**



### ROLL OUT FILING FRAME

**Specifications :**

Width	• GG09FF - 750mm width for 900mm wide unit - can take 1 row of foolscap folders
Options	• GG12FF - 1050mm width for 1200mm wide unit - can take 2 rows of foolscap folders

**Features :**

- Store foolscap folders and roll out for easy access to files

**Finishes :**

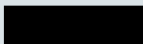
	White China
	Black

**Certifications :**



### SLOTTED SHELF AND DIVIDERS

**Specifications :**

Shelf Options	• GG09SLOT - Suits 900mm W unit
	• GG12SLOT - Suits 1200mm W unit
Dividers	GS7D - pack of 5 slotted shelf dividers

**Finishes :**

	White China
	Black

**Certifications :**



**Features :**

- Slotted shelf for use in tambour door cupboards
- Accepts separate slotted shelf dividers
- Rear support for dividers
- Reinforced shelf for heavy duty durability and stability
- Great for dividing documents and folders
- Holds folders vertically



## SHELVING UNIT - GSC9422

### Specifications :

Overall Width	910mm
Overall Depth	400mm
Overall Height	2200mm

### Features :

- Flat packed
- Clip together easy to assemble
- Includes 5 adjustable shelves
- In silver grey finish only
- 40kg weight rating per shelf

### Finishes :

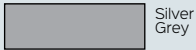

Silver Grey

### Certifications :



## GO STEEL WARDROBE - GWA18

### Specifications :

Overall Width	910mm
Overall Depth	450mm
Overall Height	1830mm

### Features :

- Lockable GO steel swing door wardrobe
- Hanging rail and 3 shelves
- 4 separate storage compartments
- Fully lockable
- Supplied with 2 keys

### Finishes :

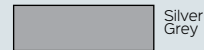

Silver Grey

### Certifications :

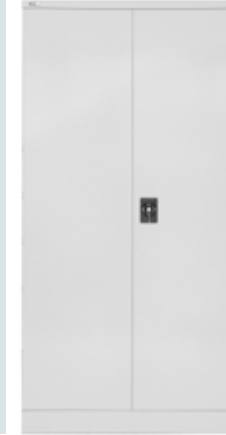

## OFFICE LOCKER - OFL138N WC

### Specifications :

Overall Width	800mm
Overall Depth	486mm
Overall Height	1375mm

### Features :

- Space efficient storage system for offices
- 6 lockable individual compartments per unit
- Removable shelf per locker
- Mail slot on each door
- Name holder fitted to each door
- 4 easy adjustable levelling feet
- Unit finished in powdercoat
- Combination locking system with private and public functions available

### Finishes :



White China

### Certifications :



NEW

## GO STEEL CUPBOARD

### Specifications :

Size	910mm W x 450mm D
Height	• GCA10 - 2 shelves - 1015mm
Options	• GCA18 - 3 shelves - 1830mm
	• GCA20 - 4 shelves - 2000mm

### Features :

- GO steel flush lock cupboard
- Supplied with 2 keys
- GCWSG Shelf and coat rail as optional extra for use in cupboard

### Finishes :

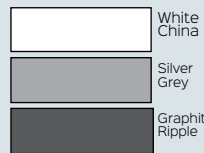

White China

Silver Grey

Graphite Ripple

### Certifications :



\*Graphite Ripple



\*White China

## CHAIR MATS FOR CARPETS

### Specifications :

MAT S	<ul style="list-style-type: none"> <li>• Small</li> <li>• 915mm W x 1200mm D x 2mm T</li> </ul>
MAT L	<ul style="list-style-type: none"> <li>• Large</li> <li>• 1150mm W x 1350mm D x 2mm T</li> </ul>

### Features :

- Composition: PVC - 75%, DDTP (PVC Plasticizer) - 20%, ABS - 2%, Stabilizer - 2%, Colour Pigment - 1%
- Dimpled mat for low pile carpet floors
- Tested for fire retardancy

### Finish :



Clear

### Certifications :



## CHAIR MATS FOR HARD FLOORS

### Specifications :

MAT SM S	<ul style="list-style-type: none"> <li>• Small</li> <li>• 915mm W x 1200mm D x 2mm T</li> </ul>
MAT SM L	<ul style="list-style-type: none"> <li>• Large</li> <li>• 1150mm W x 1350mm D x 2mm T</li> </ul>

### Features :

- Composition: - PVC - 75%, DDTP (PVC Plasticizer) - 20%, ABS - 2%, Stabilizer - 2%, Colour Pigment - 1%
- Use smooth for hard floors
- Tested for fire retardancy

### Finish :

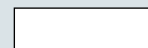

Clear

### Certifications :



## UTILITY TROLLEY - TR3

### Specifications :

Overall Width	800mm
Overall Depth	600mm
Overall Height	900mm
Weight Rating	100kg

### Features :

- Utility trolley
- 3 tiers of storage space
- Castor wheels for ease of movement
- Strong, sturdy frame

### Finish :

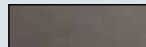

Ironstone

### Certifications :



## CORNER LOZENGE

### Specifications :

LOZENGE25	Suits 25mm thick desks
LOZENGE33	Suits 33mm thick desks
Overall Width	250mm
Overall Depth	480mm

### Features :

- Converts desk and return to a corner workstation
- Adds diagonal for user to sit at
- Fits 25mm or 33mm deep melamine tops

### Finishes :

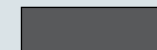

Graphite

### Certifications :





# MELAMINE LOCKERS

Melamine lockers offer a personal storage solution that blends into your space. Use in both office and educational applications. Each locker includes 2 x keys per lock.

Various internal features in each compartment. Moisture resistant melamine and MDF doors with soft close hinges, and adjustable levelling feet to each unit.

Certifications :



## STEP DOOR - SDWRML380/2

### Specifications :

Overall Height	1850mm
Overall Width	380mm
Overall Depth	455mm

### Features :

- MR Melamine carcass
- MDF doors
- Soft close hinges
- Adjustable leveling feet
- 1 x hanging rail per compartment
- Includes 2 x keys per lock
- Digital Lock option for extra

### Finish Options :



## SINGLE LOCKER - WRML-305/1

### Specifications :

Overall Height	1850mm
Overall Width	305mm
Overall Depth	455mm

### Features :

- MR Melamine carcass
- MDF doors
- Soft close hinges
- Adjustable leveling feet
- 1 x hanging rail
- 1 x hat shelf
- Includes 2 x keys per lock
- Digital Lock option for extra

### Finish Options :

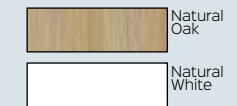

Melamine lockers offer a personal storage solution that blends into your space. Use in both office and educational applications. Each locker includes 2 x keys per lock.

Various internal features in each compartment. Moisture resistant melamine and MDF doors with soft close hinges, and adjustable levelling feet to each unit.

**Finish Options :**



**Certifications :**



**2 DOOR LOCKER - WRML-305/2**

**Specifications :**

Overall Size 1850H x 305W x 455D

**Features :**

- MR Melamine carcass
- MDF doors
- Soft close hinges
- Adjustable leveling feet
- 1 x hanging rail per compartment
- Includes 2 x keys per lock
- Digital Lock option for extra

**3 DOOR LOCKER - WRML-305/3**

**Specifications :**

Overall Size 1850H x 305W x 455D

**Features :**

- MR Melamine carcass
- MDF doors
- Soft close hinges
- Adjustable leveling feet
- 3 x Locker compartments
- Includes 2 x keys per locker
- Digital Lock option for extra

**4 DOOR LOCKER - WRML-305/4**

**Specifications :**

Overall Size 1850H x 305W x 455D

**Features :**

- MR Melamine carcass
- MDF doors
- Soft close hinges
- Adjustable leveling feet
- 4 x Locker compartments
- Includes 2 x keys per locker
- Digital Lock option for extra

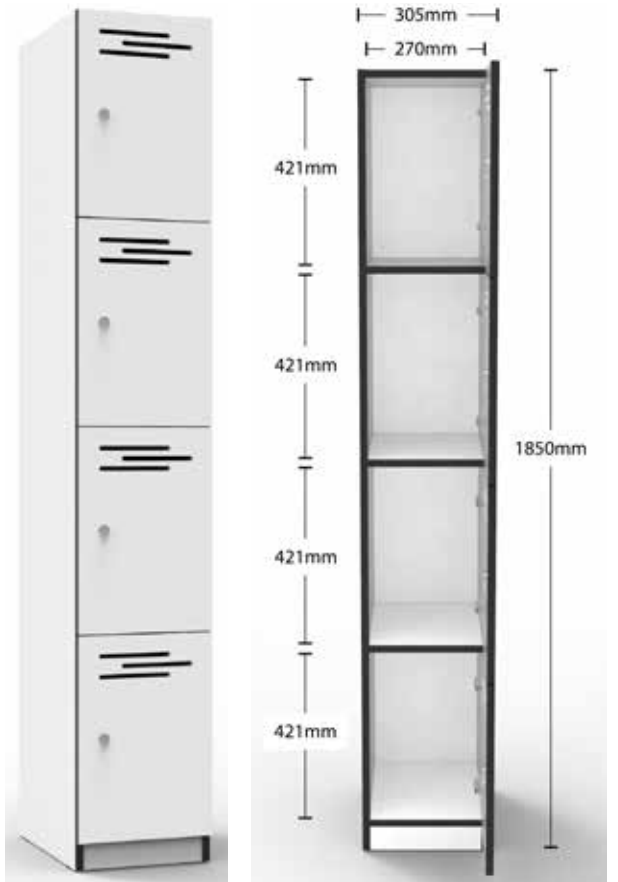
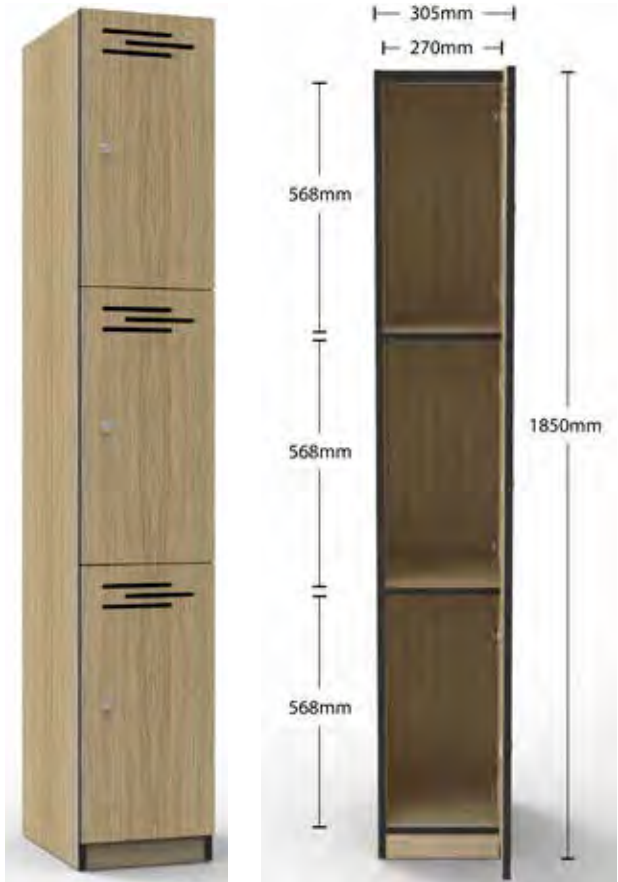
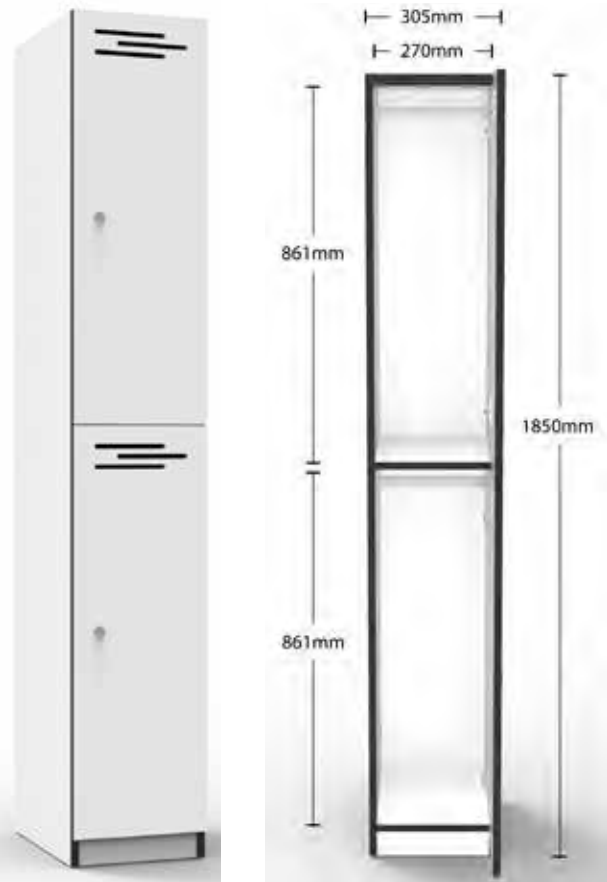

# STEEL LOCKERS

Steel lockers offer an easy way to store personal belongings. Includes 2 keys supplied per locker compartment. Choose from single, 2 or 4 door options to suit your requirements, or a step locker which provides 2 hanging spaces.

## Finish Options :

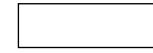

White China  
(305W units only)



Silver Grey  
(305W & 380W units)



### SINGLE DOOR LOCKER

#### Specifications :

Width Options	• GL305/1 - 305mm • GL380/1 - 380mm
Size	1830mm H x 455mm D

#### Features :

- Riveted construction for extra strength
- Vented doors for ventilation
- 1 x hat shelf, 1 x coat rail storage
- Full length stiffeners fitted to each door for rigidity

### 2 DOOR LOCKER

#### Specifications :

Width Options	• GL305/2 - 305mm • GL380/2 - 380mm
Size	1830mm H x 455mm D

#### Features :

- Riveted construction for extra strength
- Vented doors for ventilation
- 1 x coat hook per compartment
- Full length stiffeners fitted to each door for rigidity

### 4 DOOR LOCKER

#### Specifications :

Width Options	• GL305/4 - 305mm • GL380/4 - 380mm
Size	1830mm H x 455mm D

#### Features :

- Riveted construction for extra strength
- Vented doors for ventilation
- Full length stiffeners fitted to each door for rigidity

### STEP LOCKER - GSL380

#### Specifications :

Overall Size	1830H x 380W x 455D
--------------	---------------------

#### Features :

- Riveted construction for extra strength
- Vented doors for ventilation
- 1 x hanging rail per compartment
- Full length stiffeners fitted to each door for rigidity
- \*Silver Grey finish only



## LOCKER STAND

### Specifications :

Width Options	<ul style="list-style-type: none"> <li>• SB2305 - 610mm W for 2 lockers</li> <li>• SB3305 - 915mm W for 3 lockers</li> </ul>
Size	455mm D x 150mm H

### Finishes :

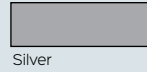

Silver

### Features :

- Locker stand to bank 2 or 3 lockers
- Suitable for 305mm wide lockers only
- Silver powdercoated frame and black levelling feet
- Raise lockers off floor to allow for easy cleaning underneath and extra stability when joined together



## SEAT AND STAND

### Specifications :

Width Options	<ul style="list-style-type: none"> <li>• S+S2305 - 610mm W for 2 lockers</li> <li>• S+S3305 - 915mm W for 3 lockers</li> </ul>
Size	700mm D x 350mm H

### Finishes :



Timber / Silver

### Features :

- Seat and stand to suit bank of 2 or 3 lockers
- Suitable for 305mm wide lockers
- Powdercoated frame and oak style seat
- Raise lockers off floor and add a bench seat in front for use in locker rooms, schools, gyms and other applications



## BENCH SEAT - BS1000

### Specifications :

Overall Size	400H x 1000W x 360D
--------------	---------------------

### Finishes :



Timber / Silver

### Features :

- Single sided bench seat
- Light oak style wood slats
- Silver coated frame
- Black levelling feet



## SLOPING TOP

### Specifications :

Width	• G12830 - for single 305mm W locker
Options	• G32830 - for bank of 3 x 305mm W lockers
Height	270mm



### Features :

- Sloping top in silver grey
- Use with either a single locker or bank of 3 lockers
- Suitable for 305mm wide lockers only
- Neat and easy to clean 30° degree sloping top

### Finishes :

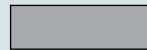

Silver



## DIGITAL LOCK

### Specifications :

Size	95H x 38W x 60D
Options	<ul style="list-style-type: none"> <li>• DIGIPRILOCK - Private lock programming</li> <li>• DIGIPUBLOCK - Public lock programming</li> </ul>



### Features :

- Digital keypad code lock to be used with steel or melamine lockers as optional extra
- Public or private lock programming
- Use with both steel or melamine lockers
- \*batteries not included\***

### Finishes :

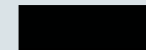

Black



## BUTTERFLY LOCK - BUTTERFLY

### Specifications :

Padlock Requirements	Suitable for use with padlock shafts 6mm-8mm and shackle 25mm-30mm
----------------------	--



### Features :

- Butterfly lock for use with all GO Steel lockers to enable padlock facility on doors (padlock not included)
- Supplied fitted to lockers when ordered simultaneously

### Finishes :

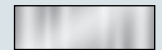

Chrome





WORKSTATIONS - FURNITURE - SEATING - STORAGE - ACCESSORIES

