



# HIVE 2



# USER GUIDE

Version 2.1.1  
22. July 2021

# Table of Contents

<b>Introduction</b>	<b>4</b>
Installation .....	4
User Interface .....	5
Performance .....	7
Control Bar .....	7
Synth Engine .....	9
Lower Bar .....	10
<b>Preset Browser</b>	<b>11</b>
Overview .....	11
Directory Panel .....	12
Presets Panel .....	15
Preset Info .....	17
Installing Soundsets .....	17
Preset Tagging .....	18
Search Functions .....	19
<b>Panel Reference</b>	<b>23</b>
Oscillator (OSC) .....	23
Sub-Oscillator (SUB) .....	25
Filter .....	25
Envelopes (AMP / MOD) .....	28
Low Frequency Oscillators (LFO) .....	29
Function Generators .....	30
Shape Sequencer .....	32
Keyboard (KEYS) .....	36
Modulation Matrix .....	38
<b>Wavetables</b>	<b>42</b>
<b>Arpeggiator &amp; Sequencer</b>	<b>45</b>
Clock .....	46
Arpeggiator (ARP) .....	46
Sequencer .....	48
<b>X/Y Pads</b>	<b>50</b>
XY Macro Assignment .....	50
XY Custom Assignment .....	51

<b>Effects (FX)</b>	<b>52</b>
Distortion .....	53
Reverb .....	54
Equalizer.....	55
Chorus .....	55
Phaser .....	56
Compressor .....	57
Delay .....	58
FX Preset.....	59
<b>Scope</b>	<b>60</b>
<b>Configuration</b>	<b>61</b>
About MIDI CC .....	61
MIDI Learn.....	62
MIDI Table .....	63
Preferences Page.....	64
<b>Inside the Hive</b>	<b>66</b>
Matrix Sources.....	66
Matrix Targets .....	67
MIDI Specialities .....	69
<b>NKS</b>	<b>70</b>
<b>Tips &amp; Tricks</b>	<b>71</b>
Setting Volumes.....	71
432 Hz Tuning .....	71
Using Constant .....	71
Pulse Width Modulation .....	72
Wavetable Tricks .....	72
Filter Tricks .....	72
Envelope Tricks .....	73
LFO Tricks .....	73
Shape Sequencer Tricks .....	73
Function Generator Tricks .....	74
Mod Matrix Tricks .....	75
XY Pad Tricks .....	77
Arpeggiator & Sequencer Tricks.....	77
Delay & Reverb Tricks .....	77

# Introduction

## Installation

---

Go to the [Hive](http://www.u-he.com) page at [www.u-he.com](http://www.u-he.com), download the installer for your system and unzip the compressed file. Open the “Hive” folder and start the installer application. The only demo restriction is a mild crackling sound at irregular intervals after about two minutes of use, which will disappear after you have entered a serial number. By default, recent versions of Hive use the following directories:

<b>Win</b>	presets (local)	<i>C:\Users\YOU\Documents\u-he\Hive.data\Presets\Hive\</i>
	presets (user)	<i>C:\Users\YOU\Documents\u-he\Hive.data\UserPresets\Hive\</i>
	preferences	<i>C:\Users\YOU\Documents\u-he\Hive.data\Support\ (*.txt files)</i>
	microtuning	<i>C:\Users\YOU\Documents\u-he\Hive.data\Tunefiles\</i>
	alternative skins	<i>C:\Users\YOU\Documents\u-he\Hive.data\Support\Themes</i>
	other resources	<i>C:\Users\YOU\Documents\u-he\Hive.data\</i>
<b>Mac</b>	presets (local)	<i>Macintosh HD/Library/Audio/Presets/u-he/Hive/</i>
	presets (user)	<i>Macintosh HD/Users/YOU/Library/Audio/Presets/u-he/Hive/</i>
	preferences	<i>Macintosh HD/Users/YOU/Application Support/u-he/com.u-he.Hive...</i>
	microtuning	<i>Macintosh HD/Library/Application Support/u-he/Tunefiles/</i>
	alternative skins	<i>Macintosh HD/Library/Application Support/u-he/Themes/</i>
	other resources	<i>Macintosh HD/Library/Application Support/u-he/Hive/</i>

## Online resources

For downloads, news articles and support, go to the [u-he website](#)

For lively discussions about u-he products, go to the [u-he forum](#) at KVR

For friendship and informal news updates, go to the [u-he facebook page](#)

For video tutorials and more, go to the [u-he youtube channel](#)

For our soundsets and bundles, go to [u-he soundsets](#)

For 3rd party presets, go to [Patchlib](#)

## Team 2021 (Q3)

Urs Heckmann (boss, concepts)

Jayne Klimek (office management)

Howard Scarr (user guides, presets, necessary grump)

Rob Clifton-Harvey (IT admin, backend development)

Sebastian Greger (GUI design, 3D stuff)

Jan Storm (framework, more code)

Alexandre Bique (all things Linux)

Oddvar Manlig (business development)

Viktor Weimer (support, presets, the voice)

Thomas Binek (QA, bug-hunting, presets)

Henna Gramentz (office supervision, support)

Frank Hoffmann (framework, new browser)

Alf Klimek (tagging, rock-stardom, studio)

Sebastian Hübert (media, synthwave)

David Schornsheim (more code)

Stephan Eckes (yet more code)

Luca Christakopoulos (communication design)

Alternative skin ‘Izmo’ by Yuta Yoshimatsu <https://plugmon.jp>

Special thanks to Brian Rzycki for maintaining the original Patchlib.

# User Interface

Here's an overview of the panels, followed by some important details about Hive's controls.

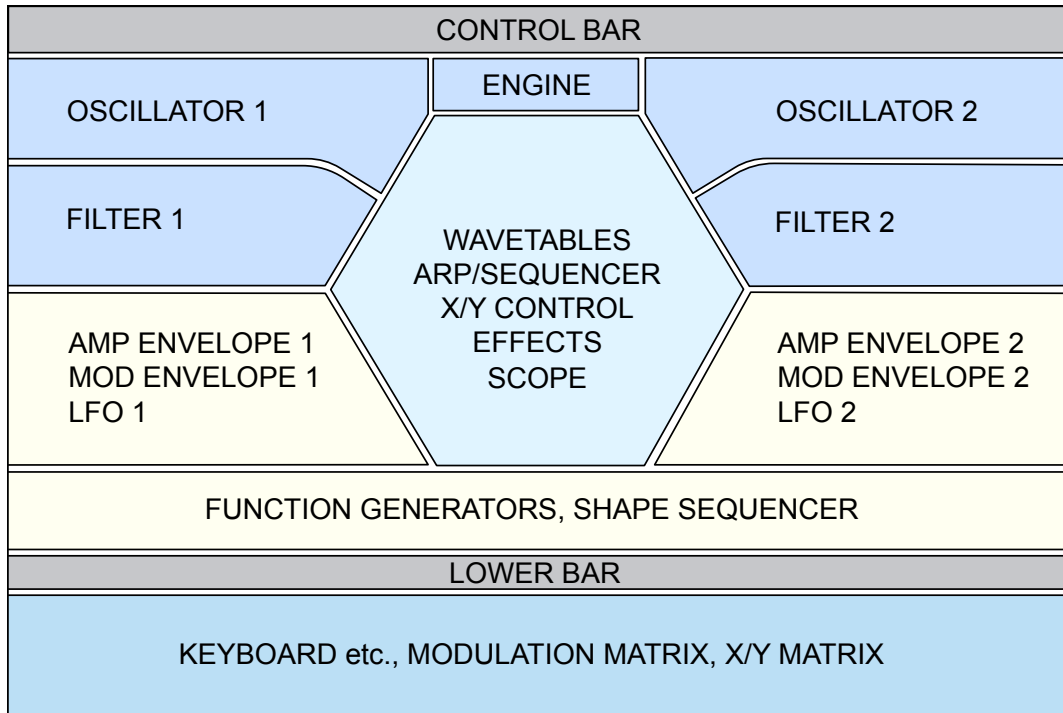

The symmetrical arrangement encourages users to layer two relatively simple voices: A powerful approach to synth design with a grand tradition (for instance the Yamaha CS80 or Korg 800 DV).

## Basic Elements

Dark grey arrows in this diagram represent stereo signals, while the blue arrows are modulation paths which are immediately available without requiring the modulation matrix.

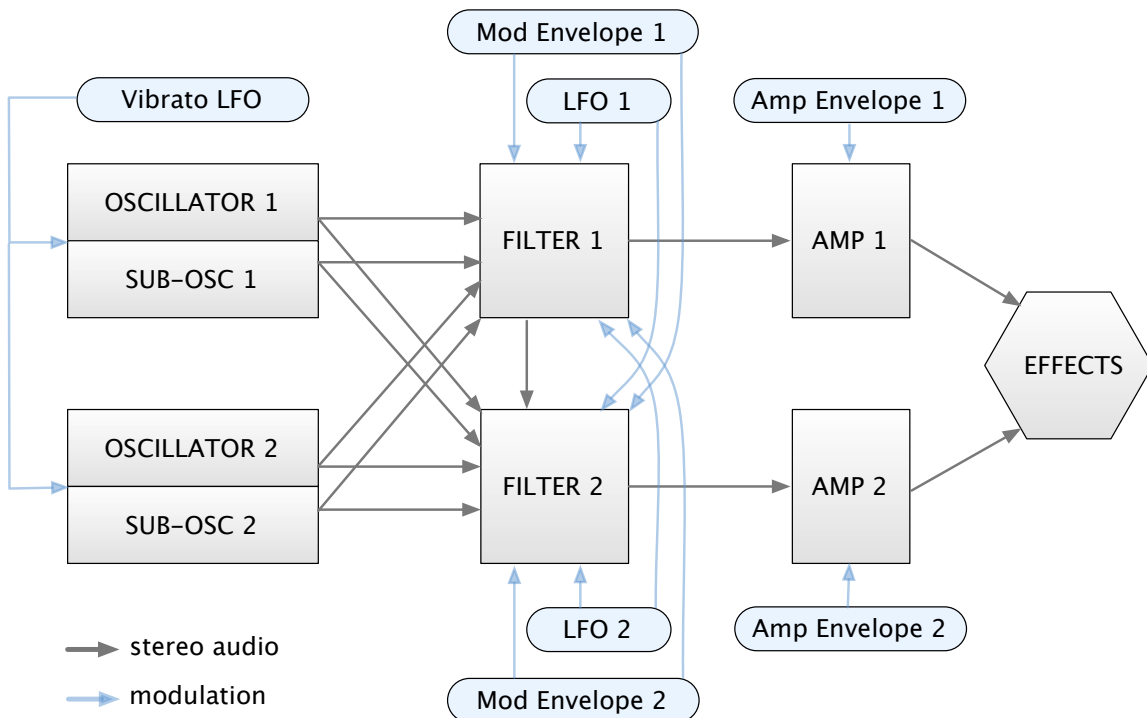

## Knobs / Sliders

Hive controls react to left-click & drag as well as the mouse wheel, while a right-click opens a context menu. Double-click to reset a parameter to its default. You can **FINE TUNE** values by holding a SHIFT key before either clicking on the control or rolling your mouse wheel.

## Parameter Locking

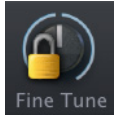

To ensure that a parameter value doesn't change when you switch presets, most of the controls can be locked. To do this, right-click the control and select *Lock* in the context menu. Note that locked parameters can still be adjusted manually!

## Drag & Drop Modulation



The [modulation matrix](#) can be populated remotely by dragging these 'crosshairs' or one of the sources in the [lower bar](#) (wheels, pressure, velocity etc.) onto any modulation target. Assignments are removed again by right-clicking on either the source or target and selecting *remove modulation* from the context menu.

You might be surprised at some of the possible targets: For instance most of the selectors in the OSC panels do something: If the Waveform is Pulse or Wavetable, its graphic is a valid target. It's a good idea to try them all and look in the matrix to see what appears.

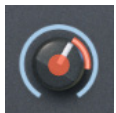

While the assigned source is simply highlighted, orange-coloured depth controls (the central dot here) and range indicators (the arc here) appear at the target. Click and drag the dot to remotely adjust the modulation Depth in the matrix. Double-click to reset, right-click to remove the modulation assignment again.

## Panel Presets



Next to each panel's label is a triangle you can click to copy, save or load panel settings. Note: Those for ARP/SEQ and FX are fields which display the preset name. To locate panel presets on your hard disk, select *Show in Finder / Explorer*.

## Solo Buttons



To the right of each title in the oscillator and filter panels is a button labelled 'S' (Solo). Just like on an audio mixer, activating Solo isolates a module so that you can check its contribution to the overall sound.

## GUI Size

Hive's window can be temporarily resized to anywhere between 70% and 200% of the standard size: Right-click in the background and choose a size from the context menu. Values that are larger than your screen will appear greyed-out and cannot be selected here.

To set this more permanently, change the [Default Size](#) preference in the [Configuration](#) pages.

## Control Link



Activating the large button between Filter 1 and the hexagon will **link** many controls on the right to the corresponding controls on the left. Linked controls are marked with a blue L. Note that the controls on the right will not necessarily adopt the *absolute* values of those on the left, as movement is relative.

## Performance

All Hive factory presets can be played **expressively** using the left-hand performance controls of a MIDI keyboard (and sometimes aftertouch), so that playing Hive is a more enjoyable experience.

Many factory presets also respond to **Control A** and **Control B** messages, Hive's general-purpose MIDI controls. See [MIDI Specialities](#).

And: You should always try out the **XY pads**! All presets include XY pad control, as any unused 'dimensions' are automatically filled with usable assignments the next time the preset is loaded. Alternatively, try the row of 8 knobs at the bottom of the PRESETS window or the corresponding encoders on [NKS](#) hardware. All of these are equivalent – see [XY Pads](#).

## Control Bar

Hive's top panel hosts several global parameters plus a few utility functions. The lefthand side...

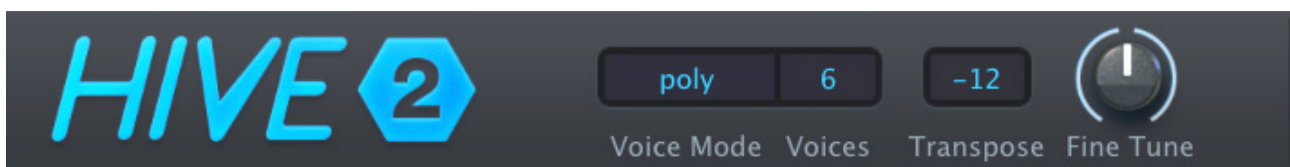

### Voice Mode

The *poly* option is polyphonic, *mono* is monophonic with retrigger, *legato* is monophonic without retrigger. In *duo* mode, oscillator 1 only responds to the lowest played note while oscillator 2 only responds to the highest played note.

### Voices

This sets the maximum number (2-16) of voices that can be played simultaneously.

### Transpose

Shifts incoming MIDI notes +/- 24 semitones.

### Fine Tune

+/- 100 cents overall pitch offset for all oscillators and filters (assuming 100% key follow).

### Data Display

Apart from showing the preset name, the central text display has several other duties:

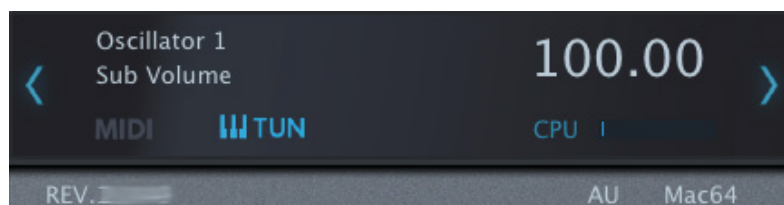

**Loading presets:** Click on the arrows step through presets, or in the middle to select a preset from the current directory. While a parameter is being adjusted you will see its value. Another little helper: If you drag a preset from e.g. your desktop and drop it onto the Data Display, it will be loaded but not automatically saved.

**Initialize preset:** Whenever you want to program a new sound from scratch, right-click on the data display and select *init*.

**Status Indicators:** At the bottom of the data display you will see a row of indicators. The MIDI activity indicator flashes whenever MIDI data is being received. The TUN symbol turns blue if microtuning is active. The horizontal bar to the right indicates approximate CPU usage.

**Revision:** Hover over the 'REV. nnnn' label to view the core revision number in the data display.

On the **righthand side** of the control bar we have the following...

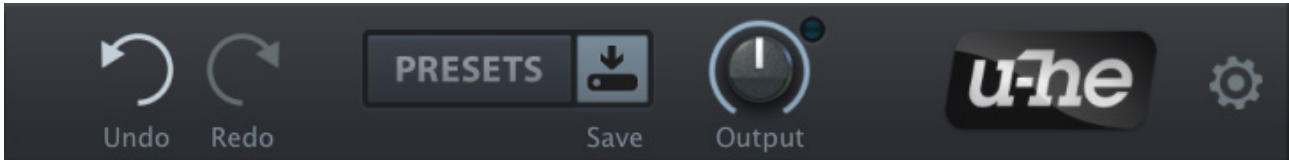

## Undo / Redo

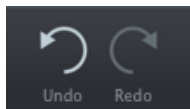

Click on the curved arrows to undo (maximum 10 steps) or redo an action. You can even undo a change of preset so that you don't lose any edits made to the previous one.

## PRESETS



Opens and closes Hive's browser. See the [Preset Browser](#) chapter.

## Save



Stores the loaded preset in either the User folder or the currently open folder, depending on the status of the [Save Presets To](#) preference. If you are running the VST2 version you will also see the option `.nksf` in the list. See the [NKS](#) chapter.

Right-clicking on the [SAVE] button lets you set the preset format you will be using. The standard is `.h2p`, which has the advantage of being cross-platform compatible. The `.h2p extended` format is similar but also allows per-line comments – the preset files are therefore slightly larger.

Clicking on the final *Tag this patch* entry opens a window where you can specify CATEGORY, FEATURE and CHARACTER tags for the currently loaded preset. See [Preset Tagging](#).

## Output

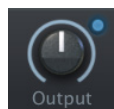

This is Hive's main volume control, accompanied by a signal level indicator.

Most of the factory presets have Output set to 100. Higher values are available so you can boost very quiet signals up to 'normal' levels if necessary.

## u-he Badge



Click on the badge for links to our website, to this user guide and other Hive documents, to our user support forum at KVR and to our social network pages.

At the very bottom of the menu is the entry *Install Soundset...* Unless you are running Linux you probably won't need this. See [Installing Soundsets](#).

## Configuration cogwheel



Clicking on the cogwheel symbol at the top-right opens the configuration pages where you can set up remote control via MIDI CC as well as several **global preferences**. See the [Configuration](#) chapter.



# Synth Engine

The selector immediately above the hexagon is in such a prominent position because it presents a rather important choice: SYNTH ENGINE **fundamentally affects the character** of Hive by simultaneously swapping out parts of the 'circuitry' while adjusting the behaviour of others.

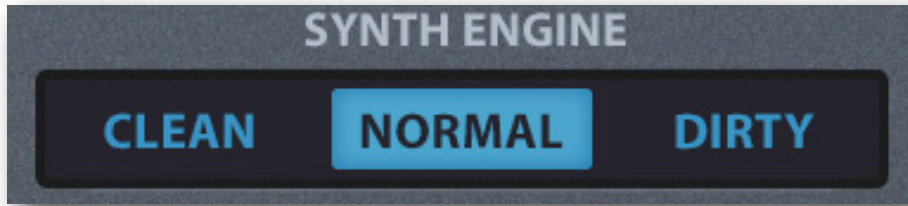

- CLEAN.....Wide oscillator detune, linear attack, exponential decay and release, perfectly linear i.e. non-distorting **State Variable** filter without oversampling. In filter modes *Comb*, *Dissonant* and *Reverb*, a dynamic limiter prevents build-up.
- NORMAL.....Exponential oscillator detune law, s-curve envelope attack, short punchy decays, oversampled, self-oscillating **Ladder** filter with non-linear resonance. In filter modes *Comb*, *Dissonant* and *Reverb*, a dynamic limiter prevents build-up.
- DIRTY.....Evenly-spaced oscillator detuning, exponential envelopes, oversampled self-oscillating **Steiner-Parker** (Sallen-Key diode ring) filter... This filter is similar to the classic Korg™ MS-20, but unbuffered so that current from the second pole leaks back into the first pole. Very smooth when tamed, but can get very screaming and erratic! Adds distortion to filter modes *Comb*, *Dissonant*, *Reverb* and *Sideband*.

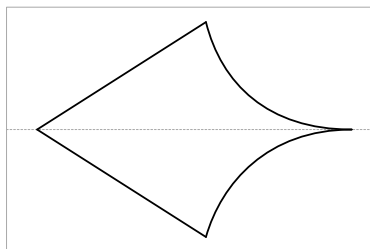

All CLEAN mode envelopes

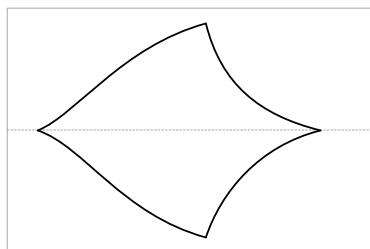

NORMAL mode AMP envelopes

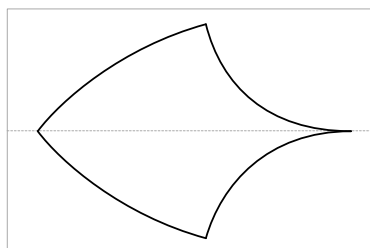

NORMAL mode MOD + all DIRTY mode envelopes

## Lower Bar

---

### View Selectors

Below the main panels is a narrow bar containing **view selectors** for the lower panel – click on any of these to switch the contents of the lower panel.

On the left are selectors for [KEYS](#), [MATRIX A](#) or [MATRIX B](#):

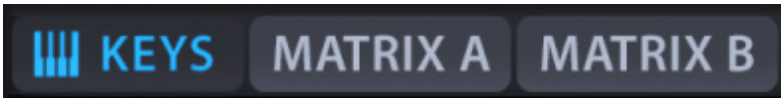

On the right are selectors for [XY pad custom assignment](#):

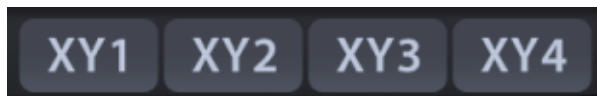

### Drag & Drop Modulation Sources

These work like the **crosshair symbols** in the main panels, giving you drag & drop access to the most common modulation sources that don't belong in any of those panels:

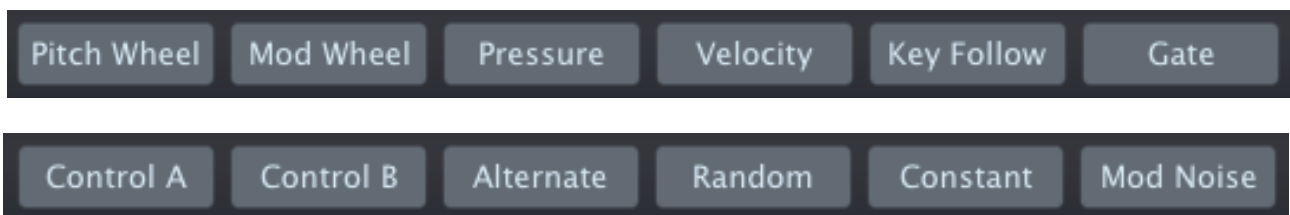

<b>Pitch Wheel</b>	pitch-bend controller
<b>Mod Wheel</b>	modulation depth controller, MIDI CC #01
<b>Pressure</b>	a.k.a. aftertouch, either channel pressure or poly AT
<b>Velocity</b>	MIDI velocity, how hard you play a note on your keyboard
<b>Key Follow</b>	modulation source derived from MIDI note number plus glide
<b>Gate</b>	simple on/off envelope
<b>Control A/B</b>	the two user-definable <a href="#">MIDI CC</a>
<b>Alternate</b>	per note toggle between extreme values -100 and +100
<b>Random</b>	per note random value between -100 and +100 (see also <a href="#">Sample &amp; Hold (SH)</a> )
<b>Constant</b>	+100 (also per note!)
<b>Mod Noise</b>	nose similar to LFO Random Glide at maximum speed

See also [Drag & Drop Modulation](#) on page 6.

# Preset Browser

## Overview

To open Hive's preset browser, click on the **[PRESETS]** button in the upper bar.



Folders appear on the left, presets in the centre and information about the currently active preset appear on the right. If you can't see any presets at all, click on *Local*. If you can't see the PRESET INFO panel, click on the button in the top right and select *Show Preset Info*.

The *Local* root directory contains a representative selection of presets copied from the subfolders. After selecting a preset here you can step through the others using your computer's cursor keys.

Bottom right is an effects bypass switch so you can compare presets with and without effects. The lower panel mirrors the XY pad controls so you can also test those while browsing.

If you want the preset browser to open automatically every time you load a new instance of Hive, right-click on the **[PRESETS]** button while the browser is active and select *Set as Default View*.

## Default preset

Whenever Hive is started it checks whether the Local root contains a preset called *default*. If this file exists, it is loaded instead of the demo preset. Note that *default* will not appear in the browser.

If you want Hive to start with a simple template every time instead of the default preset, do this: Right-click on the data display, select *init* (initialize) and make any minor adjustments you like. Make sure that the preference [Save Presets To](#) is set to 'selected folder' and that the 'Local' root directory is currently open. Finally, [Save] your preset under the name *default*.

## Directory Panel

If you don't see this panel on the left of Hive's Presets browser, click on the DIRECTORY tab.

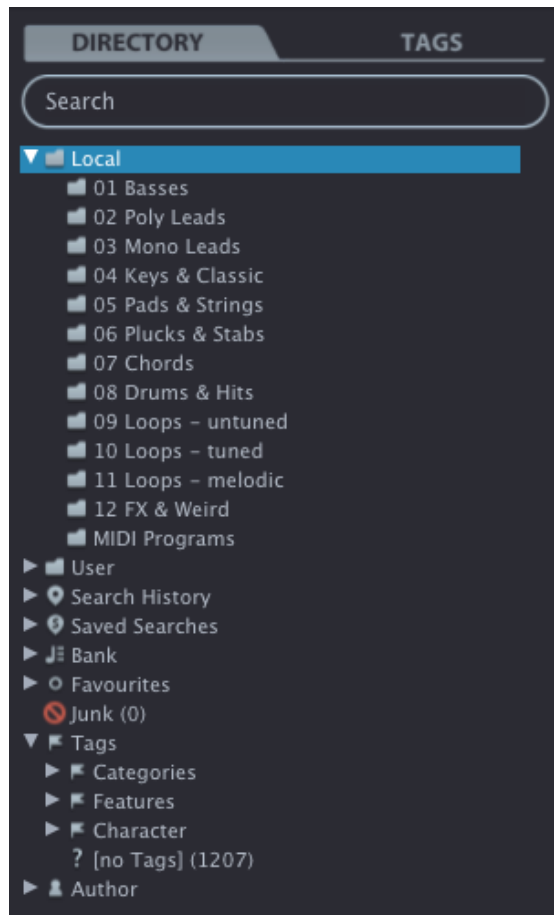

### Local

Hive's factory presets are sorted into folders 1 through 12. We recommend that you do not add or remove presets here, but save all your creations and other soundsets in 'User' (see below).

Note: Hive version 1.x included an extra folder called TREASURE TROVE containing presets kindly submitted by Hive fans shortly before the official release. Several of these have now been polished in-house and included in the version 2 factory presets, while all others have become a separate download available from Patchlib ([u-he.com/community/patchlib/](http://u-he.com/community/patchlib/)).

### MIDI Programs

As well as the categorized factory presets, 'Local' also contains a folder called 'MIDI Programs' which is normally empty. When the first instance of Hive starts, up to 128 presets in the MIDI Programs folder are loaded into memory so they can be selected via *MIDI Program Change* messages. For more details, see [MIDI Specialities](#) towards the end of this document.

### User

The best address for your own creations as well as soundsets from other sources. You can either select *User* immediately before saving the preset, or set a global preference which ensures that it will always be saved somewhere within this folder – see the [Save Presets To](#) preference.

Tip: It's worth finding out where the *User* folder resides on your computer, especially if you want to manually install soundsets. Simply right-click on *User* and select *Open in Finder / Explorer*.

## Smart Folders

The other folders do not contain files, but display the results of querying a database of presets. The content is therefore dynamic i.e. it will change whenever the underlying data changes.

You can **drag & drop** any smart folder content (even 'Junk') onto e.g. 'User' or the desktop (see [External Drag & Drop](#)) to create folders containing real copies of those presets!

### Search History

Click on this folder to display the results of past searches (maximum 10). Whenever you need to make the results of a search more permanent, right-click and select *Save Search...* The entry will be moved to the 'Saved Searches' folder. To remove all searches from the list, right-click on the 'Search History' folder and select *Clear*.

### Saved Searches

A list of searches saved via right click from Search History. To remove individual entries, right-click on the search and select *Delete*.

### Bank

These smart folders reference metadata about preset **origin** – the version of the factory library or the name of the soundsset with which the preset was installed. See [Preset Info](#) below. Banks are (or will be) predefined for factory presets as well as u-he soundssets.

You can even create your own custom banks: Drag & drop one or more presets onto the 'Bank' folder then enter a suitable bank name into the dialogue box.

To remove Bank attributes from selected presets, either drag & drop them onto the 'no Bank' folder you will see at the bottom of the Bank list, or right-click on the Bank and select *Remove Presets from Bank*. Empty Banks will disappear.

### Favourites

8 smart folders, one for each Favourite colour. See [Presets context menu](#). Presets dropped onto a 'Favourites' folder will be marked accordingly. Only one Favourite colour/number can be set per preset. Favourites can be imported / exported - see [External Drag & Drop](#) below.

You can clear the Favourite status from all presets of one particular colour / index by right-clicking on the 'Favourite' folder and selecting *Remove All Favourite (n) Marks*.

### Junk

A smart folder pointing to *junked* presets (see [Presets context menu](#)). Files dropped onto this folder will normally disappear from the browser, but you can select *Show Junk* in the presets context menu. Like Favourites, Junk can even be exported/imported (as *Junk.uhe-fav*).

Junk marks can be removed globally by right-clicking on the Junk folder and selecting *Remove All Junk Marks*. If hidden, all junked presets will reappear in the browser.

### Tags

Smart folders for each Category/Subcategory, Features and Character tag. Presets dropped onto these folders will adopt the corresponding tag. Presets dropped onto the '[no Tags]' folder will have all Category/Subcategory, Features and Character tags removed.

### Author

Smart folders for each Author i.e. the contents of the 'author name' field as defined while a preset is being saved. Tip: Instead of signing each of your creations individually when you save them, you could sign the first one only to create your Author folder, then drag & drop any others onto that same folder. As this process cannot be undone, please use it with caution!

## Directory Context Menu

Right-clicking on any folder within *Local* or *User* will open this menu:

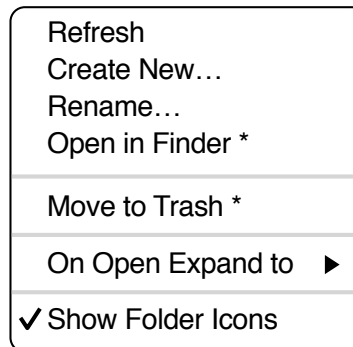

### Refresh

This function forces the Hive browser contents to be updated. Although it will also work on a Mac, *Refresh* is mainly aimed at Windows users: It is necessary after any files or folders have been moved, added, removed or renamed using Explorer.

### Create New...

Insert an empty subdirectory.

### Rename...

Edit the folder name.

### Open in Finder / Explorer

Opens a system window for the currently selected folder. If you hold down the option key (Mac) or ctrl key (Windows), this entry will change to 'Show in Finder / Explorer' and the folder will be highlighted instead of opened.

### Move to Trash / Recycle Bin

Moves the selected folder to the system trash. If you right click on the *Junk* folder, this entry will be replaced by 'Remove All Junk Marks'. If you right click on a *Bank* smart folder, it will be replaced by 'Remove Presets from Bank' (see [Smart Folders](#) above).

### On Open Expand to

These options determine how deeply the browser will open subdirectories whenever the GUI is (re)opened or the refresh function is called. The first *none* option collapses all folders, while the final *all levels* option reveals all nested folders.

### Show Folder Icons

Deselect this option if you find the folder icons distracting. The Junk icon is not affected.

## Presets Panel

The central, unlabelled area of the browser displays all presets in the current folder. Click to select.

### Presets context menu

Right-click to open a menu containing functions that can be applied to individual presets.

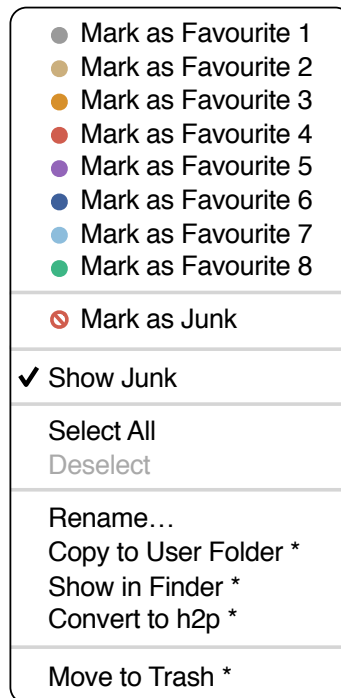

#### Mark as Favourite

Tick one of 8 ‘favourites’. The selected entry will be replaced with *Unmark as Favourite*.

#### Mark as Junk / Show Junk

Instead of deleting unloved presets, mark them as ‘junk’ so that they disappear from the browser. Activate Show Junk to display junked files instead, and mark them with a STOP symbol.

#### Select All, Deselect

See ‘Multiple selection’ on the next page.

#### Rename...

You can change the names of presets using this function. Note that only the most recently selected preset can be renamed i.e. you can’t rename multiple files at once.

#### Copy to User Folder / Duplicate

The entry here depends on the status of the Save Presets To preference as well as on the location of the source preset(s) i.e. whether they are in the Local or the User folder. Selected presets are copied with a number appended to the name, which increments (just like the ‘Auto Versioning’ option) so that no preset can be overwritten by mistake.

#### Show in Finder / Explorer

Opens a system window for the right-clicked file. In smart folders only, holding down an *option* key (Mac) or *ctrl* key (Windows) replaces this entry with *Show in Browser*, which shows the currently selected file in its original location within Hive’s browser.

### **Convert to native / h2p / h2p extended / nksf:**

Converts selected preset(s) into the format previously specified via right-click on the [SAVE] button.

### **Move to Trash / Recycle Bin:**

Moves selected presets to the system 'trash'.

## **Restore**

At the top left of the Presets panel is a button labelled [RESTORE]. This lets you audition presets to your heart's content without losing track of the one that was loaded before you opened the browser. Clicking on [RESTORE] navigates to that preset and reloads it.

## **Scan / ready**

In the top right of the presets panel is a dark rectangle normally labelled 'ready'. Whenever you use the *Refresh* function (see the *Directory context menu* on the previous page), this turns into a progress indicator showing the preset database being refreshed. The process should only take a few seconds, even for a large preset library.

## **Multiple selection**

A block of adjacent presets can be selected via shift+click, and presets added to the selection via cmd-click (macOS) or alt+click (Windows). Presets can be moved to another folder via drag & drop. To deselect, click on any unselected preset or choose *Deselect* from the context menu.

## **Internal Drag & Drop**

You can drag and drop single or multiple files from the preset panel onto any folders in the directory panel. Files dragged onto regular folders will be moved unless you hold down *option* (Mac) or *ctrl* (Windows), in which case they will be copied instead. Files dropped onto smart folders will adopt the attribute of that folder: For instance, you can set e.g. the Author or Favourite status of several presets at once.

## **External Drag & Drop**

To manage your preset library externally you can drag presets and folders between Hive's browser and your desktop (or any system window). On the Mac, most Finder operations will automatically update the browser. Updating might not be immediate when using multiple formats or multiple host applications, but all it usually takes is a click on the GUI or in the directory tree (sets focus to the clicked instance of Hive).

On Windows, a manual *Refresh* (see [Directory Context Menu](#)) will be required before changes to the contents of the browser appear.

Another little helper: If you drag a Hive preset from e.g. your desktop and drop it onto the Data Display, that preset will be loaded (but not automatically saved).

### **Exporting smart folders**

Drag any smart folder onto the desktop to create a new folder containing those presets. Drag an entry from your Search History, or the Category 'Duo', or one of the Authors...

### **Exporting favourite status**

You can export Favourites, either all at once or individually: Shift+click and drag the 'Favourites' folder or one of its sub-folders onto the desktop to create a file called *Favourite (n).uhe-fav*. Such files can then be imported into Hive's browser on a different computer (for instance), via drag & drop onto the Favourites folder or anywhere within Favourites.

Note: Importing *.uhe-fav* files from another computer will only work 100% correctly if all preset names and locations are identical on both computers!



## Preset Info

---

The panel to the right displays information about the selected preset. If you can't see this panel, click on the triple bar [≡] button in the top right corner and tick *Show Preset Info*:

- ✓ Show Preset Info
  - ✓ Show Tags in Preset Info

Below the preset name you should see its path (from /Local or /User), the Bank and the Author (which also appear as [smart folders](#)).

**DESCRIPTION** and **USAGE** text is entered immediately before saving a preset.

**CATEGORIES**, **FEATURES** and **CHARACTER** are the tags for the currently selected preset (see [Preset Tagging](#)). You can remove or add tags directly here (see [Tagging via PRESET INFO](#)).

If you prefer to see less information, hide the tags only or the entire PRESET INFO panel.

## Installing Soundsets

---

All soundsets we distribute ourselves will (eventually) be available in *.uhe-soundset* format. Third parties are also encouraged to use this package format for their own commercial soundsets (for details please contact our [support](#) team).

### Standard Method

To install, drag & drop the *.uhe-soundset* file into Hive – anywhere will work. The soundset should appear in the 'User' folder. If a soundset with the same name already exists in that location, any modified files will be backed up and the location of the backup file will be displayed.

### Alternative Method

Soundsets in *.uhe-soundset* format can also be installed by clicking on the u-he badge, selecting *Install Soundset...* from the menu and navigating to the *.uhe-soundset* file. This option is especially useful for Linux, as the browser version for that platform does not support drag & drop.

### Regular Folders

Folders containing Hive presets can be manually copied or moved into the 'User' folder. You might have to refresh the browser (see [Directory context menu](#)) before they appear there. A refresh is generally necessary in Windows but not in macOS.

Note: As *.uhe-soundset* files are basically ZIP-compressed folders, you can rename them i.e. replace the long file extension with 'zip', then extract the presets and accompanying documentation.

# Preset Tagging

**Tags** are elements of metadata, information added to presets so you can find them more easily.

**IMPORTANT**

Tags are updated automatically – clicking on the [SAVE] button isn't required! The main advantage is that presets don't have to be saved every time you edit a tag. The main caveat is that **you should only edit tags after saving your preset.**

For instance, if you decide to edit tags while creating a 2nd version of an existing preset, please remember that you are actually changing the tags in the original preset!

## The Tagging Window

Right-click on the [SAVE] button and select *Tag this Patch*:

CATEGORY	FEATURE	CHARACTER																																
<table border="1" style="width: 100%; border-collapse: collapse;"> <tr><td style="background-color: black; color: white;">Bass</td></tr> <tr><td>Pads</td></tr> <tr><td>Leads</td></tr> <tr><td>Keys</td></tr> <tr><td>FX</td></tr> <tr><td>Drums</td></tr> <tr><td>Seq+Arp</td></tr> <tr><td>Other</td></tr> </table>	Bass	Pads	Leads	Keys	FX	Drums	Seq+Arp	Other	<table border="1" style="width: 100%; border-collapse: collapse;"> <tr><td>Acoustic</td></tr> <tr><td>Analogue</td></tr> <tr><td>Digital</td></tr> <tr><td style="background-color: black; color: white;">Dist+LoFi</td></tr> <tr><td>E-Bass</td></tr> <tr><td>FX Bass</td></tr> <tr><td>Plucks</td></tr> <tr><td>Rhythmic</td></tr> <tr><td style="background-color: black; color: white;">Sub</td></tr> <tr><td>Sync</td></tr> <tr><td>Synth</td></tr> <tr><td>Vocal</td></tr> </table>	Acoustic	Analogue	Digital	Dist+LoFi	E-Bass	FX Bass	Plucks	Rhythmic	Sub	Sync	Synth	Vocal	<table border="1" style="width: 100%; border-collapse: collapse;"> <tr><td>Bright</td><td style="background-color: black; color: white;">Dark</td></tr> <tr><td>Constant</td><td>Moving</td></tr> <tr><td style="background-color: black; color: white;">Clean</td><td>Dirty</td></tr> <tr><td>Soft</td><td>Aggressive</td></tr> <tr><td>Phat</td><td>Thin</td></tr> <tr><td>Natural</td><td>Synthetic</td></tr> </table>	Bright	Dark	Constant	Moving	Clean	Dirty	Soft	Aggressive	Phat	Thin	Natural	Synthetic
Bass																																		
Pads																																		
Leads																																		
Keys																																		
FX																																		
Drums																																		
Seq+Arp																																		
Other																																		
Acoustic																																		
Analogue																																		
Digital																																		
Dist+LoFi																																		
E-Bass																																		
FX Bass																																		
Plucks																																		
Rhythmic																																		
Sub																																		
Sync																																		
Synth																																		
Vocal																																		
Bright	Dark																																	
Constant	Moving																																	
Clean	Dirty																																	
Soft	Aggressive																																	
Phat	Thin																																	
Natural	Synthetic																																	
	<table border="1" style="width: 100%; border-collapse: collapse;"> <tr><td>Mono</td></tr> <tr><td>Poly</td></tr> <tr><td>Duo</td></tr> <tr><td>Chord</td></tr> <tr><td style="background-color: black; color: white;">BPM</td></tr> <tr><td>Comb</td></tr> <tr><td>Modulated</td></tr> <tr><td>Dry</td></tr> <tr><td>Percussive</td></tr> <tr><td>Soft Attack</td></tr> <tr><td>Slow Release</td></tr> <tr><td style="background-color: black; color: white;">Glide</td></tr> <tr><td>Wavetable</td></tr> </table>	Mono	Poly	Duo	Chord	BPM	Comb	Modulated	Dry	Percussive	Soft Attack	Slow Release	Glide	Wavetable																				
Mono																																		
Poly																																		
Duo																																		
Chord																																		
BPM																																		
Comb																																		
Modulated																																		
Dry																																		
Percussive																																		
Soft Attack																																		
Slow Release																																		
Glide																																		
Wavetable																																		

**Category** describes a preset by analogy to instrument types or typical usage, and each one has an appropriate set of subcategories. **Features** are technical classifications, and **Character** tags are pairs of opposites from which you can choose only one.

## Tagging via PRESET INFO

In the PRESET INFO panel, right-click on the *Category*, *Features* or *Character* and select or unselect tags from the menu. Note that this method only works for individual presets. If you right-click on an existing tag, the first option in the menu becomes *remove tag*.

The function *Create Search from Tags* finds all presets with exactly the same set of *Category*, *Features* and *Character* tags.

## Tagging via smart folder

You can tag presets by dropping (“drag & drop”) any number of presets onto one of the *Tags* smart folders. To remove all tags, drag them onto the ‘[no Tags]’ smart folder.

# Search Functions

## Search by Tags

Click on the [TAGS] tab to open this view. The buttons here let you set up search criteria according to existing tags with just a few mouse clicks:

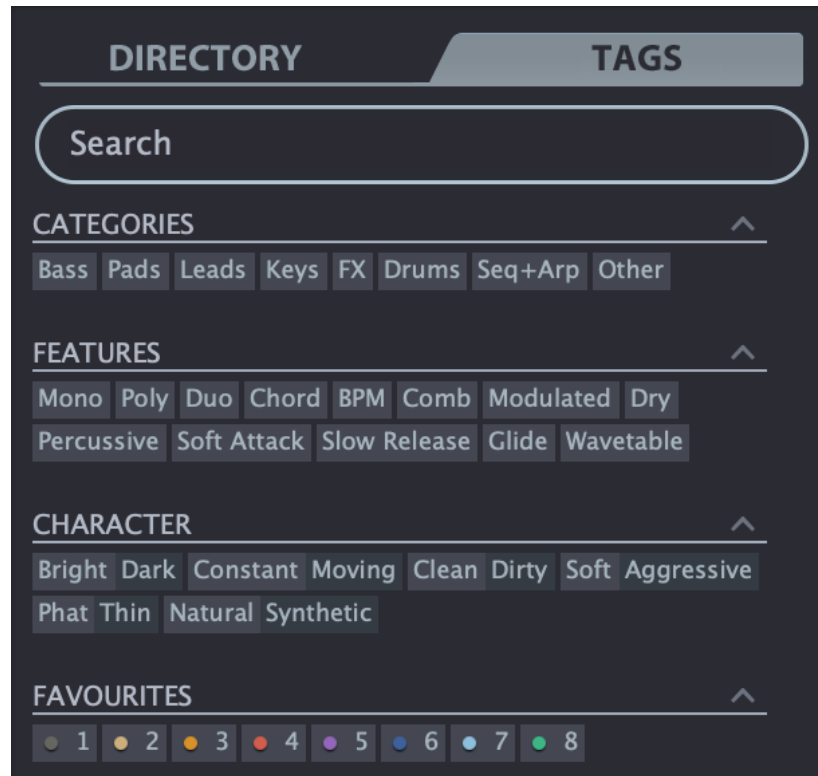

Below the Search field are four sets of buttons (CATEGORIES, FEATURES, CHARACTER and FAVOURITES). The first three correspond to the tags in the tagging window (see the previous page), while the bottom row lets you find any presets you have tagged as *Favourites*.

Clicking on the [^] icon to the right of each heading hides the options for that set of tags.

## Categories and Subcategories

Especially for *Category* tags, following a step-by-step tutorial (see the next page) is much easier than studying a full technical description, so here are just a few pointers:

Each Category has its own set of subcategories which appear below the main categories. Click on [Leads] and see them appear. Not selecting a subcategory here means “show me presets tagged with **any** subcategory”. Selecting the top-left subcategory (which has the **same name** as the category) means “show me presets tagged **without any** subcategory”. You should not find any of these in the factory presets!

You can select multiple categories without specifying subcategories if you hold **command** (Mac) or **alt** (Windows) while clicking on the category button. Try that with the [Keys] button.

Completed category+subcategory tags appear below the subcategories as buttons with ‘off’ switches [X] so that you can add other main categories by simply clicking on them.

So far we have actually been *expanding* the search, which is not very useful...

## Search by Tags Tutorial

- Click on the DIRECTORY tab and open the *Local* root folder if it is closed. Double-click on the *Local/06 Plucks & Stabs* folder to limit the scope of the search to that particular folder. The selected path appears immediately below the *Search* field instead of preset folders.
- Click on the TAGS tab. In the Categories, select [Bass]. Subcategory buttons appear and the preset window is updated to list all presets in *06 Plucks & Stabs* that are tagged as [Bass]. In Hive 1.x there was only one, namely *XS Bubblegum*. In Hive 2 there are 3.
- Now click on [Keys]. The [Bass] category is switched off, and the preset window is updated to list all presets in *06 Plucks & Stabs* that are tagged as [Keys]. There are quite a lot of those! Note that you haven't specified a subcategory yet...
- Hold down the command (Mac) or alt (Win) key and click on the [Bass] category again. The [Keys] category remains highlighted and the list shows all presets in the *06 Plucks & Stabs* folder that have either of those tags, disregarding any subcategories.
- Click on the DIRECTORY tab again: The text "#Bass:\* #Keys:\*" appears in the editable field as well as in the *Search History* smart folder, followed by the number of found presets. The colon symbol ':' functions as a separator between Category and Subcategory, while the star (\*) means "any Subcategory, even none".
- Click on the TAGS tab. Select the [Leads] category without holding down *command/alt* this time. The [Bass] and the [Keys] tags are removed from the search. Select the [Digital] subcategory. The result is a list of all presets in the *06 Plucks & Stabs* folder that have the *Leads:Digital* tag. Below the subcategories you will see the complete tag in the form [Category:Subcategory|X].
- Let's get some more hits by including another subcategory: Click on the [Synth] subcategory. The tag [Digital] remains selected, and the list of hits is updated to include presets which have either of those tags. Click on [Digital] again and the tag search will find fewer presets – only those that are tagged as [Leads:Synth] in the *06 Plucks & Stabs* folder.
- Click the [Drums] category. Below the subcategories, the [Leads:Synth|X] tag remains in place because it is complete (Category with Subcategory). Check the tags in the PRESET INFO by clicking on presets in the central list: Each preset will include a *Leads:Synth* tag or a *Drums* tag (with any or no subcategory), or both.
- Click on the DIRECTORY tab. The text *#Drums:\* #Leads:Synth* appears in the Search field as well as the Search History smart folder. If you are feeling adventurous, you can try editing the characters in the Search field – after hitting Return, the results will be updated accordingly.
- To the left of the grey search path is an 'up' [^] symbol. Click on this to exit the current folder, which in this case changes the search path from *Local/06 Plucks & Stabs* to the *Local* root. The list now includes many more presets because the range of the search spans all of *Local*.
- Another click on [^] expands the scope to the entire preset library i.e. */Local* plus */User*. Note that clicking on the [X] symbol to the right of the search path will immediately exit any subfolder.
- Repeat the above a few times if necessary – you'll soon get the hang of it!

## Features, Character and Favourites

Unlike multiple Category tags which expand the search, these types **restrict** the search. As a practical example let's find all "thin" and "moving" presets with a slow release...

Click on the TAGS tab. If any Categories are highlighted, click on them. Select [Slow Release] feature, then the [Thin] and [Moving] characters. You should now see about 10 hits in the pre-sets panel – which is generally a good number to aim for while searching!

## Summary

In the DIRECTORY panel, specify a **search path** via double-click. In the TAGS panel, select category tags. Add others if required to extend the search, but remember to hold down **command** (Mac) or **alt** (Windows) if you want to retain category tags that don't specify a subcategory. Select Features, Character and/or Favourites tags to refine the search.

Remember to exit the search path (if there is one) afterwards!

## Search by Text

The **Search Field** lets you find presets according to a text string. An example: If you remember that the preset you want has the word "clock" in its name or description, simply enter *clock* into the Search field and hit Return...

This basic search normally looks into the preset name, author, the DESCRIPTION and USAGE (see the PRESET INFO panel). Searches are not case-sensitive, and quotes are not required unless you need to include spaces.

To restrict the search to a particular path, for instance *Local/05 Pads & Strings*, double click the *05 Pads & Strings* folder. This path will appear immediately below the Search field instead of the preset folders, and you will only see folders within the specified path (if any exist) plus the usual bunch of smart folders:

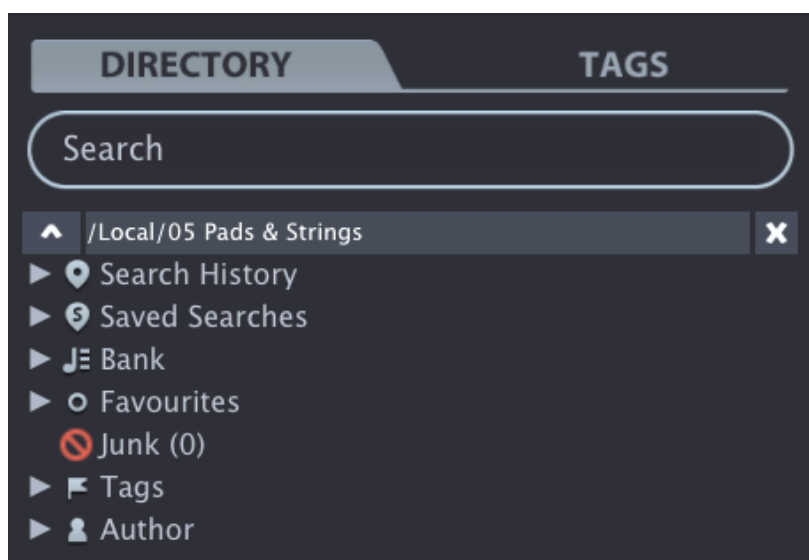

The **Search Path** (below the Search Field): The [^] button to the left moves the search path up one level, in this case up to */Local*. Alternatively, you can navigate directly to any higher level by right-clicking on the path. The [X] button to the right expands the path to include all Hive presets (in *'Local'* as well as in *'User'*), and all the regular preset folders will reappear.

Try a text search: Enter three or four letters then hit Return. For instance, *star* would find all files containing the text string *star* (e.g. *mustard* or *starters*). Entering "*star wars*" with the quotation marks would find e.g. *Battlestar Warsaw*.

## Syntax

You can limit the scope of the search to just the preset name or specific parts of PRESET INFO by using **name** (preset name), **author**, **desc** (description) or **use** (usage) followed by a colon. For instance, *author:the* finds all presets by sound designers whose author names contain 'the'. Similarly, *desc:space* will find all presets with the word *space* in the description.

### Logical Operators

The following logical operators can only be used between text elements.

**AND** requires that presets contain both words. It can be written explicitly if you prefer, but is not necessary. For example, *star AND wars* (or simply *star wars*) will find presets that contain both *star* and *wars*.

**OR** means that presets can contain just one of the words or both. For example, *star OR ship* will find presets that contain *star* as well as presets that contain *ship*.

**NOT** excludes presets containing the word. To find all presets that contain *star* but don't contain *ship*, enter *star NOT ship*.

### Including Tags

Tags must appear after any text items.

Regular tags can also be entered into the search field if preceded with a '#'. For example, *name:"hs " #bass:\** will find all presets with "hs " in the name that are tagged as *Bass* with any or no subcategory. The colon separates Category and Subcategory, and the star (\*) means "any subcategory, even none".

Note: Between multiple tags of the same type is an implicit **OR**, while between different types is an implicit **AND**.

### Example searches

You could copy/paste these into Hive's search field and see what they find. Note that tags are automatically removed from the search field and appear as active tag buttons instead.

*desc:classic* = presets with the word "classic" in the description

*author:ark* = presets by Arksun

*use:"at =" author:how* = aftertouch-controlled presets by howard

*tuc OR xs #pads:strings* = strings by either The Unshushable Coktor or Xenos

*tuc OR NOT xs #pads:strings* = strings by The Unshushable Coktor or anyone except Xenos

# Panel Reference

This chapter describes all of Hive's main synthesis panels i.e. everything except the hexagon.

## Oscillator (OSC)

Hive's oscillators feature Unison ('hyperwave'), stereo panning and a freely tuneable sub-oscillator:



### Waveform

To change the waveform, click on the field above the graphic and choose from the menu (or hover over it and roll the mouse wheel):

The **Sine**, **Sawtooth**, **Triangle** and **Square** options are classic waveforms that shouldn't require further explanation. **Half** and **Narrow** are pulse waveforms with differing widths.

**Pulse** sounds like Square at first, but you can control *Pulse Width* in the modulation matrix by dragging & dropping a modulation source onto the Waveform graphic. (Tip: Use Constant as the source if you want to set the pulse width to a fixed value). See [Hidden Parameters](#).

**White** and **Pink** are two standard variants of noise: White is bright, Pink is darker.

**Wavetable** is Hive's most powerful oscillator mode. You can load special *.wav* samples or *.uhm* script files containing up to 256 individual waveforms ('frames').

Some wavetable parameters are available directly in the oscillator panel. The 3 triangles are for quickly **selecting a wavetable** file: The downward-pointing triangle opens the complete menu while the other two select the previous and next wavetable file in the directory. To adjust the frame **Position** (POS) within the wavetable, click anywhere on the graphic and drag vertically.

The graphic area is also the drag & drop target for Position modulation. For other wavetable parameters, click on the [WAVETABLE] buttons in the hexagon and read the [Wavetables](#) chapter. If you are interested in creating your own wavetables, check out *Hive Wavetables.pdf*, which you will find in the **Docs Folder** – right-click on the u-he badge.

### Unison

Stacking multiple waves results in a richer sound, especially when detuned, at the cost of a higher CPU load. Note that Unison only works for the SUB Waveform if it is set to *like Osc*.

### Octave / Semitone

Semitone tuning within a range of +/- 3 octaves. These settings apply to the entire oscillator i.e. the sub-oscillator's Tune value is an offset relative to the Octave and Semitone settings.

Drag & drop a modulation source onto either selector for the [hidden parameter oscillatorTune](#).

## Phase

“Phase” is basically the horizontal position of a waveform. The switch here gives you a choice of three modes which govern oscillator phase at the start of each note:

*Reset* .....For consistent / robotic attack. The phase in Reset mode is normally 0°, but this can be modulated (see *Real-time phase control* below).

*Random*.....Phase is set to a random value whenever a note is played. Very organic.

*Flow*.....The phase of a new note picks up where the previous one left off, so any beating between oscillators is continuous.

Although the difference between Random and Flow can be rather subtle, *Flow* is closest to how oscillators in a classic analogue polyphonic synth behave. For technical reasons, *Flow* works as described for the main oscillators only, not for the sub-oscillators (see the next page).

**Real-time phase control** is a [hidden parameter](#). If you drag & drop any modulation source onto the Phase selector, a Phase control assignment will appear in the modulation matrix.

## Detune

If ‘Unison’ is set to 1 this knob is a simple fine tune control: Oscillator 1 is tuned up and oscillator 2 tuned down within a range of one semitone.

If Unison is set to 2 or more, the multiple waves are detuned in opposite directions. In this case the sub-oscillator isn’t affected unless its Waveform is set to *like Osc*.

It might not be obvious, but you can still fine tune the overall pitch of unison oscillators: In the modulation matrix, set the source to *Constant* and the target to *Tune*, then adjust the modulation amount while holding a SHIFT key.

## Width

If Unison (see above) is set to 2 or more, this controls the stereo width of the signal around the current pan position. If Unison is set to 1, the Width control has no effect.

## Pan

Controls the pan position of the oscillator, including sub-oscillator.

## Volume

The amount of main oscillator signal sent to the filters. The sub-oscillator has its own volume control. See also [Setting Volumes](#) in the Tips & Tricks chapter.

## Vibrato

The amount of cyclic pitch modulation from the [Vibrato LFO](#). Also applied to the sub-oscillator.

Tip: For typical vibrato via modulation wheel go into the modulation matrix, click on a panel pre-set button (downward-pointing triangle) and select *01 Vibrato via MW*.



## Sub-Oscillator (SUB)

### Waveform

The sub-oscillator's Waveform selector contains the same options as the main oscillator but without Wavetable. The extra option at the top of the list, **like Osc**, means that the sub-oscillator will inherit the Waveform and Unison settings from the main oscillator.

### Tune

Sub-oscillator tuning relative to that of the main oscillator. Hold down a SHIFT key to fine tune.

### Volume

The sub-oscillator's own volume control. See also [Setting Volumes](#).

## Filter



### Filter Type

To swap out the filter type, click on the field above the graphic and select from the menu:

**Bypass**.....Disables the filter circuit. The oscillator input switches as well as the Input and output Volume controls remain functional while the Cutoff, Resonance, Mod Env and LFO controls have no effect.

**Lowpass 24**.....Removes frequencies above the cutoff point: **24** dB per octave.

**Lowpass 12**.....Removes frequencies above the cutoff point: **12** dB per octave.

**Bandpass**.....Removes both low and high frequencies, while allowing a band of frequencies around the cutoff to pass through.

**Highpass**.....Removes frequencies below the cutoff point.

**Bandreject**.....Removes a narrow band while allowing lower and higher frequencies to pass. Practically the opposite of Bandpass (see above).

**Peaking**.....Like Bypass but with active resonance. Use this mode to accentuate a certain frequency e.g. for bass boost or mid-range 'honk'.

For the next 4 modes, the **Filter Type** display looks rather different...

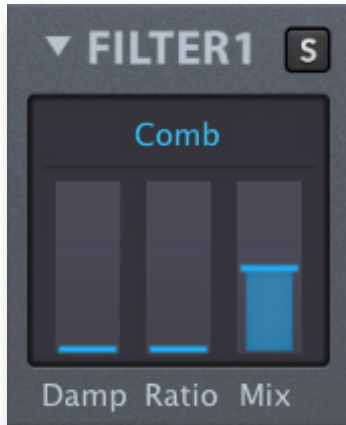

If you select the **Comb**, **Dissonant**, **Reverb** or **Sideband**, vertical sliders appear in place of the frequency response graphic. These can create envelope-driven polyphonic flanging, strange spaces, realistic strings, dynamic percussion instruments, clangorous bells and much more.

The first three are “comb filter” variations based on short delay lines with multiple taps and feedback. They can turn a simple impulse into a slowly decaying tone. If you turn the Resonance knob (feedback) up, the frequency response curve resembles a regular row of tines / spikes, hence the name *Comb*.

**Damp** reduces feedback in *Comb*, *Dissonant* or *Reverb*.

**Mix** crossfades between the untreated and treated signals.

**Ratio** has various duties, depending on the chosen type:

*Comb* .....In this basic comb filter model, Ratios from 0 to 50 fade in a second delay tap, while values above 50 lengthen both delay times, thus lowering the pitch.

*Dissonant* .....A variant of Comb with a 4x4 feedback delay network. The Damp parameter controls the cutoff frequency of a simple lowpass filter in the feedback path, while Ratio lengthens delay times, thus lowering the pitch. The hidden filter parameter *Spread* shifts each pair of delay lines apart in stereo. *Dissonant* is especially good for metallic sounds and percussion instruments.

*Reverb* .....A variant of Comb with longer delays capable of emulating resonant bodies and ambient spaces – polyphonically! Ratio adjusts the diffusion.

*Sideband* .....This type type is not based on delay lines, but on a special kind of amplitude modulation. Essentially a frequency shifter, the metallic character is due to frequencies being shifted by a constant (e.g. 100Hz) instead of a factor (e.g. 2 times). The Ratio parameter offsets the phase of the frequency-shifted signal.

Tip: For soft bell-like sounds or bubble effects (low Cutoff), experiment with a Sine oscillator and low Resonance. For synthetic vocal sounds, try Saw or narrow pulse and maximum Resonance.

Please note that the selected [synth engine](#) significantly affects the tone of the Sideband filter. Also, with the CLEAN synth engine it sounds an octave lower than with NORMAL or DIRTY.

### Filter Input Selectors

These two rows of buttons represent the **basic audio signal routing** options in Hive. They select the input signals for each filter. Active buttons appear blue:

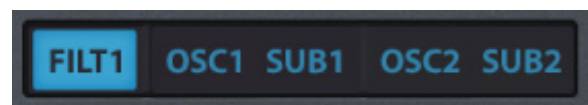
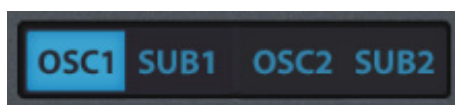

Filter 2 has an extra [FILT1] button, which is the filter 1 signal at full volume. Tip: To route the two filters **in series**, turn filter 1 Volume down to zero and activate only [FILT1] in filter 2, as in the above image on the right.

## Cutoff

Everybody's favourite synthesizer control, 'Cutoff' is the knob most likely to show signs of wear and tear on old hardware synths! There's something very satisfying about manually sweeping the cutoff, especially with at least a bit of resonance...

## Resonance

Resonance is a filter-internal feedback loop that emphasizes the cutoff frequency. In the Synth Engine modes **Normal** and (especially) **Dirty**, the amount of resonance you will hear depends on the signal input – see Input Gain above.

## Input

In **Normal** or **Dirty** [synth engine](#) mode the filter's input gain not only controls the input volume (in decibels), but also the amount of non-linear distortion – an important characteristic of real analogue filters. In **Clean** mode it simply attenuates or boosts the level. See [Setting Volumes](#).

## Mod Env

The Mod Env knob adjusts cutoff modulation from the selected envelope (MOD1 or MOD2). Tip: Turn Cutoff way up and try negative Mod Env values. This can take some getting used to. Experiment with Mod Env until you are familiar with the 'upside-downishness' of it all!



## LFO

Similarly, the LFO knob adjusts cutoff modulation depth from either LFO1 or LFO2. As this knob is also bipolar, you can make the filters move in opposite directions without using up a matrix slot. Tip: Set the LFO mode to *Gate* and experiment with LFO Phase.

## Key Follow

Cutoff modulation from **MIDI note** number. At 100% the cutoff point will track semitones played on your keyboard quite well.

Key Follow pivots around MIDI note 64, the E above middle C. All other notes are modulated up or down by Key Follow while the pivot note remains fixed.

## Volume

Filter output level. Does not affect the level of [F1] for filter 2. See also [Setting volumes](#).

## Spread

This [hidden parameter](#) shifts Cutoff in opposite directions for the left and right channels!

## Envelopes (AMP / MOD)

Hive's envelopes are arranged in pairs, symmetrically either side of the hexagon. The outer panels (AMP) control amplifier envelopes while the inner ones (MOD) control the filter / general purpose modulation (MOD) envelopes:



### Trigger

The **Gate** option is for normal triggering via MIDI Note On.

**One-shot** triggering ignores gate length: The envelope always completes the Decay. Great for percussion sounds, fly-by effects, certain pads e.g. 'HS Bloom Pad'. It usually makes sense to set Sustain and Release to minimum in this mode, but you can use higher values to create an interesting 'Hold' effect: Try setting Sustain to about 50, then test extreme Decay values.

The **LFO** options retrigger the envelope from one of the LFOs. Note: Unless you really want a randomly delayed trigger, you should avoid setting that LFO's Restart to **random**!

### A D S R

The 4 sliders control **A**ttack time, **D**ecay time, **S**ustain level and **R**elease time. Each envelope stage can be modulated in realtime – see [Envelope Tricks](#).

### Velocity

How strongly the envelope's output is affected by MIDI velocity (e.g. how fast a key is struck).

## Low Frequency Oscillators (LFO)

Hive has two regular LFOs (low frequency oscillators):



### Waveform

Click on the field above the graphic and choose a shape from the menu: The options are **sine**, **triangle**, **saw up**, **saw down**, **sqr hi-lo** (square wave starting high), **sqr lo-hi** (square wave starting low), **rand hold** (stepped random wave) and **rand glide** (smooth random wave).

### Polarity [+]

Shifts the LFO wave 'upwards' so that it outputs positive values only. The absolute output level is halved so that the maximum value cannot be exceeded.

### Phase

Where (in the waveform) the LFO will start whenever a note is played. This setting is irrelevant if 'Restart' (see below) is set to **random**. Tip: To restart a Sine wave at the highest point set the Phase to 25.00, and for the Triangle set it to 50.00.

### Rate

Shifts the LFO speed relative to the selected Time Base (see below). The range is from -5 to +5: integer steps halve or double the speed.

### Restart

Selects rules for how LFO phase is reset.

*Sync*.....LFOs of all voices are synchronized to the host, so they all adopt the same phase. Unlike Single mode (see below), the phases can still be modulated apart by a 'polyphonic' source such as Velocity, KeyFollow or Random.

*Single*.....All voices share the same LFO, which is restarted at the next MIDI note after all previous notes have been released.

*Gate*.....Notes restart the LFO for each voice independently at the specified Phase.

*Random*.....Notes restart the LFO for each voice independently at a random phase, ignoring the value of Phase.

### Time Base

The basic 'speed mode'. Time Base offers non-synchronized times measured in seconds (**0.1**, **1s** or **10s**) as well as a long list of values that are synchronized to song tempo, including dotted times (50% longer) and triplets (3 in the space of 2).

## Function Generators

Inspired by our foray into the world of Eurorack modular synthesis, Hive 2 is equipped with a pair of **Function Generators** (FG):



Hive's FGs combine simple envelope functionality with LFO, slew limiter (a.k.a. envelope follower) and gate control. Each of the three outputs has its own 'crosshair' you can drag & drop onto any valid modulation target, onto the Scope or even the modulation matrix source fields.

Triggered and/or modulated by the LFOs, the [Shape Sequencer](#) and each other, Hive's Function Generators can create some truly *mind-bending* motion effects!

### A / D

**Attack** and **Decay** times. Maximum times are 4 seconds each (8 seconds in total), and the minimum times are short enough that a cycled FG can attain low audio rates.

### Slope

The curvature of both Attack and Decay, from exponential (low) through linear (centre) to logarithmic (high). Tip: View the *Env* output in the [Scope](#).

### Input

A modulation source used to trigger the FG every time the signal moves upwards from a point close to zero. Playing a note will also retrigger the FG, regardless of the selected Input or the Mode...

### Mode

#### Envelope

Attack-Decay envelope. A trigger during decay will start the attack from the current value. For a simple note-triggered envelope, set the Input to *none* and the Mode to *Envelope* or *One Shot*.

#### One Shot

Like *Envelope* except that the Input will not retrigger the FG until the previous decay is finished. *One Shot* can create a slower rhythm from a faster LFO – see [Function Generator Tricks](#).

#### Cycle (Trig)

Looping envelope. A trigger from the selected Input during the decay will restart the attack from the current value. However, MIDI note gates will always restart the attack from zero.

#### Cycle (OnOff)

Looping envelope. The loop only continues while the input signal is above zero, after which the final value is held. Note: In this mode (only) the Input defaults to *Constant*, so if you need Still to go high when notes are released you should set the Input explicitly to *Gate*.

**Follow**

Practically a lag generator (a.k.a. slew limiter). The Attack and Decay knobs can be used to set different response rates for the rising and falling sections of the input signal. Typical applications are rounding off square LFOs or smoothing aftertouch (see Tips & Tricks). The modulation matrix's own [slew limiter](#) does a similar job, but the FGs offer more control.

**Follow (Gate)**

The *Gate* variant takes the idea further: It only follows the Input while a note is being held i.e. while the MIDI Gate is open. As soon as you release a note i.e. close the Gate, the FG's output will freeze at the current value. The release time of the amp envelope therefore plays a role here: with too short a Release you won't hear the effect.

**Gate Outputs**

Apart from the normal *Env* (envelope) output, each function generator has two gate outputs:

*Rise* ..... 1 while the function generator's envelope signal is rising, otherwise 0

*Still* ..... 1 while the envelope signal is not moving, otherwise 0

*Fall* ..... 1 while the envelope signal is falling, otherwise 0

*Move* ..... 1 while the signal is moving in either direction, otherwise 0

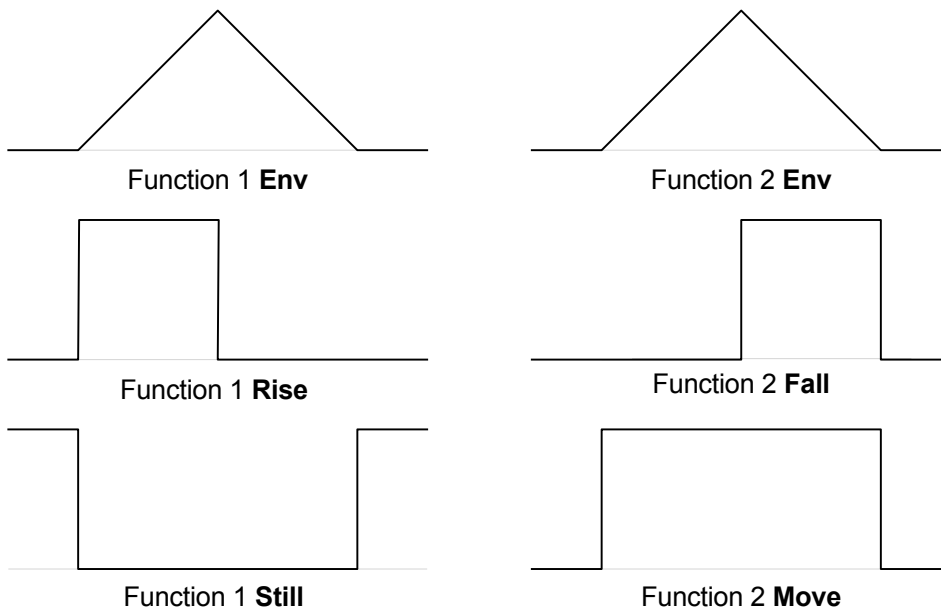

This above image shows all four gate outputs for Input = *none*, Mode = *Envelope*.

These gates are practically extra pulse LFOs with variable pulse widths (by modulating Attack and/or Decay). You can use them to trigger the other function generator or to trigger sample & hold in the matrix, for instance.

With LFO-triggered *One Shot* envelopes, the gate outputs can function as clock dividers. See the first example in the [Function Generator Tricks](#) section.

# Shape Sequencer

The Shape Sequencer is where you can create complex modulations and/or rhythmic patterns. It offers a comfortable way to 'gamify' rhythm creation. While it may look like a baby version of what other synths have to offer, Hive's shape sequencer can do a lot more than first meets the eye...

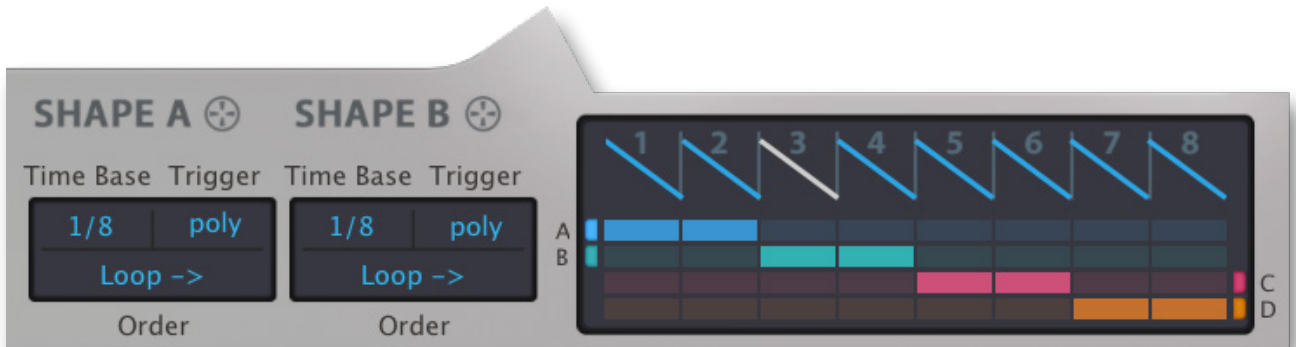

## Segment Editor

Click one of the numbered (1-8) segment selectors to opens its editor. A single click to the left or right of the expanded view selects the previous or next segment:



## Segment Type



To choose a basic waveform for the current segment, use the buttons at the bottom or right-click anywhere in the editor and select from the context menu. The options are *Saw*, *Triangle* or *Pulse*.

## Left Value, Right Value

Blue triangular handles appear to the left and right while your mouse pointer is in the editor area. Click and drag them up or down to adjust levels. Double-click in the segment selector to invert the waveform (the left and right levels are simply swapped).



### Curvature

Clicking and dragging within the editor has a different meaning for each segment type. For the Saw it adjusts **concavity / convexity**, for the Pulse the **pulse width** and for Triangle it morphs between **sine** and **sharp spike**. A double-click in the editor resets the curvature to the default.

### Ratchet

Roll your mouse wheel to smoothly 'ratchet' the segment 2, 3 or 4 times to generate triplets etc.. Remember that you can hold down a SHIFT key to 'fine tune' it!

### The Grid

Below the segment selector is an 8 x 4 grid containing an on/off button for each step. The Grid lets you set up 4 different sequences from the pool of 8 segments. While the Shape Sequencer is running, any gaps between active steps (for instance in lane B here) are simply skipped.



### Shape Modulators

The four **lanes** A, B, C and D have associated control panels which determine how the active cells are sequenced. With independent *Time Base*, *Trigger* and *Order* settings, the shape modulators can be triggered differently and run at a different speeds.



### Time Base

The basic 'speed mode'. Unlike its namesake in the LFOs, the Shape Sequencer's *Time Base* offers exclusively straight host-synchronized options between 1/32 and 4/1.

The final option 'Halt' **freezes** the shape modulator so that you can use it as a waveshaper by modulating **Position A/B/C/D**. (see 'Shape Sequencer' modulation targets).

## Trigger

The default *poly* trigger option gives you a separate Shape modulator for each voice. The *single* trigger option is essentially 'monophonic' and ensures that the sequence remains synchronized between voices for as long as you play legato.

## Order

Let's have a look at the Order options of each of those modulators:

*Loop*→.....Repeat all selected shapes from left to right  
 ←*pool*.....Repeat all selected shapes from right to left  
*Random*.....Repeat all selected shapes, randomly chosen  
*One Shot*.....Play all selected shapes once only, from left to right

As they only play a single shape, the last two modes are fundamentally different:

*One By One*.....Each note plays the next selected segment. With *single* Trigger it starts from the leftmost one, only incrementing during legato play. This behaviour is ideal for the sequencer, which restarts per played note and stays in sync.

*One Random*.....Each note plays a random segment. Unlike One by One, *single* triggering from Hive's sequencer only plays one segment until you play another note. If you want random selection at each step, use *Random* order instead.

## Modulation

The Shape Sequencer offers quite a few modulation targets, some of which are quite 'esoteric':

Rate A  
 Rate B  
 Rate C  
 Rate D  
 Left Value (A)  
 Right Value (B)  
 Curve (C)  
 Ratchet (D)  
 Position A  
 Position B  
 Position C  
 Position D

### Rate modulation

For continuous control over speed: Dragging any modulation source onto a Time Base selector creates the connection in the modulation matrix. Just like in the standard LFOs the range is from -5 to +5 and each integer step will double or halve the speed. Tip: Choose *integer quantization* in the matrix (and set that matrix slot's **SH** option to *Gate*) so that different velocities will play the sequence 2, 4, 8, 16 or 32 times as fast.

### Segment modulation

The next four targets let you dynamically modulate the following segment parameters:

*Left Value (A)*.....Vertical position of the left handle  
*Right Value (B)*.....Vertical position of the right handle  
*Curve (C)*.....Concavity / convexity, pulse width or sinusoid / spike  
*Ratchet (D)*.....Multiplication factor, from 1 to 4

Modulating all these targets separately per lane and switching the modulation on/off per cell would normally require 16 target parameters and 32 switches – we decided to simplify matters with the following compromises...

- 1) **Modulation is applied to all 4 lanes at once**, cutting the required targets down to only 4.
- 2) **Each lane ALSO functions as a row of on/off switches** for segment modulation, which cuts our extra 32 switch requirement down to zero. The letter **A, B, C** or **D** in brackets after the name of each modulation target (see the above list) is its “switch lane”.

This second point can be difficult to grasp at first, and you might have to plan your use of the 4 lanes carefully. For instance if you know you will be modulating the *Left Value* of certain segments only, it's best to avoid using lane A for anything other than the modulation switch.

Here's an example of segment modulation:

	step			
lane	1	2	3	4
A	A + C	A + D	A	
B				B + D
C	A + C			
D		A + D		B + D

Cells A1 and C1 will respond to *Left Value (A)* and *Curve (C)* modulation

Cells A2 and D2 will respond to *Left Value (A)* and *Ratchet (D)* modulation

Cell A3 will respond to *Left Value (A)* modulation only

Cells B4 and D4 will respond to *Right Value (B)* and *Ratchet (D)* modulation

### Position modulation

The last four targets, practically the **phase** of each shape sequencer lane, are mainly useful when Time Base is set to *Halt*. They are only available in the menu i.e. not per drag & drop. Modulating shape sequencer positions with Time Base settings other than *Halt* will work fine, but this can get quite complicated. Here's a simpler experiment starting from *init...*

Set SHAPE A Time Base to *halt*, go into the matrix and modulate Position A from LFO1 with its Waveform set to *saw up* and Polarity set to *positive* (activate the [+] button): The LFO now scans linearly through all active segments in lane A. Set the target to e.g. oscillator pitch so you can hear the result. Of course you can use any modulation source instead of the LFO to scan, even another lane of the shape sequencer!

Note: Negative modulation does not move the position “below zero”. It remains stuck at zero until sent positive – so it can be used to create a delay for that lane.

## Keyboard (KEYS)

The button on the left of the lower bar selects Hive's keyboard and extra pitch settings:



The panel on the left contains the following pitch-related parameters:

### Glide

Glide (a.k.a. 'portamento') slurs the pitch between consecutive notes. There are two different glide modes: in **Rate** mode ('constant rate') the glide takes longer for larger intervals, while in **Time** mode ('constant time') it is independent of the interval. **Amount** sets the glide time/rate for all oscillators and filters – anything that uses key tracking.

### Microtuning

Click in the lower half of the field to select a **microtuning table**. The [Activate] button switches microtuning on or off so you can compare the effect. Hive supports standard TUN format microtuning tables, and there are already several in the list. Many more microtuning TUN format tables are available online, most of them free. For the more ambitious user we have an online **microtuning table generator**: [u-he.com/tools/microtuning/](http://u-he.com/tools/microtuning/). To close the microtuning browser, click on the [CLOSE] button at the upper right. The .tun files belong in the following folder:

**Win**..... C:\Users\YOU\Documents\u-he\Hive.data\Tunefiles\

**Mac**..... Macintosh HD/Library/Application Support/u-he/Tunefiles/

...or equivalent locations in accordance with your VST and Hive installation paths.

To go directly to that location from within the microtuning browser, right-click on any .tun file and select *Show in Finder* (Mac) / *Show in Explorer* (Win).

### Vibrato LFO

A third LFO, hardwired to the oscillators. The **Rate** knob controls the speed and the **Delay** knob controls how slowly it fades in. See also [Vibrato](#) in the oscillator panel.

### Pitch (pitch wheel)

Most MIDI keyboards have a 'pitch bender' control, often a centre-sprung wheel or stick that bends the overall pitch up and down. You can specify up (**PB+**) and down (**PB-**) ranges independently from 0 to 24 in semitone steps, and 36 (3 octaves) or 48 (4 octaves).

### Mod (Modulation Wheel)

On-screen modulation wheel, reacts to MIDI CC#01. Note that the value you set here, either by pushing your real modulation wheel or moving this virtual version, is not saved with the preset.

## Virtual Keyboard

You can play notes with different velocities on Hive's virtual keyboard: Click close to the top for low velocities and further down for high velocities.

Double-clicking on a note will sustain it. This feature is handy for sound design if you don't have a real keyboard at hand, or even for holding a drone while playing live. To release the latched note, single-click the same note again (or click on any other note).

## Scale Quantizer

Although the lowest octave can be played just like the rest of the keyboard, it can also be used to quantize incoming MIDI notes to a particular scale. Click on the dots to include or exclude notes. For instance, here's a C minor 9th chord (C, D, Eb, G, Bb):



Chromatic  
 Monior  
 Melodic Minor  
 Harmonic Minor  
 Monor Pentatonic  
 Blues  
 Major  
 Major Pentatonic  
 Phrygian Dominant  
 Diminished  
 Dorian  
 Locrian  
 Lydian  
 Lydian Augmented  
 Mixolydian

Clear

### Scale presets

To quickly set up standard scales you can right-click on a dot and choose a preset from the menu – the selected scale will appear with the clicked note as its root. There is also a handy *Clear* function so you never have to deselect all dots individually.

### In Scale Transpose

At the bottom of the oscillator modulation target menu is a Scale Quantizer related option which shifts notes within the specified scale. What that means is best demonstrated by a little experiment...

Starting with a simple arpeggio preset choose a Scale preset, open the mod matrix (see the next page) and assign your modulation wheel to control *In Scale Transpose* at maximum Depth. To avoid glitches, set the [sample & hold](#) (SH) trigger for the matrix slot to 'Gate'. In addition to the mod wheel you could also try modulating *In Scale Transpose* from a slow LFO with Restart set to *sync* or *single*.

# Modulation Matrix

The **mod matrix** is used for connecting modulation **sources** (MIDI controls, envelopes, LFOs etc.) to one or two modulation **targets**.

There are 12 units with 2 targets each. As each unit is quite large, the matrix is split into two pages of 6 units each, selected by the [MATRIX A] and [MATRIX B] buttons in the lower bar:

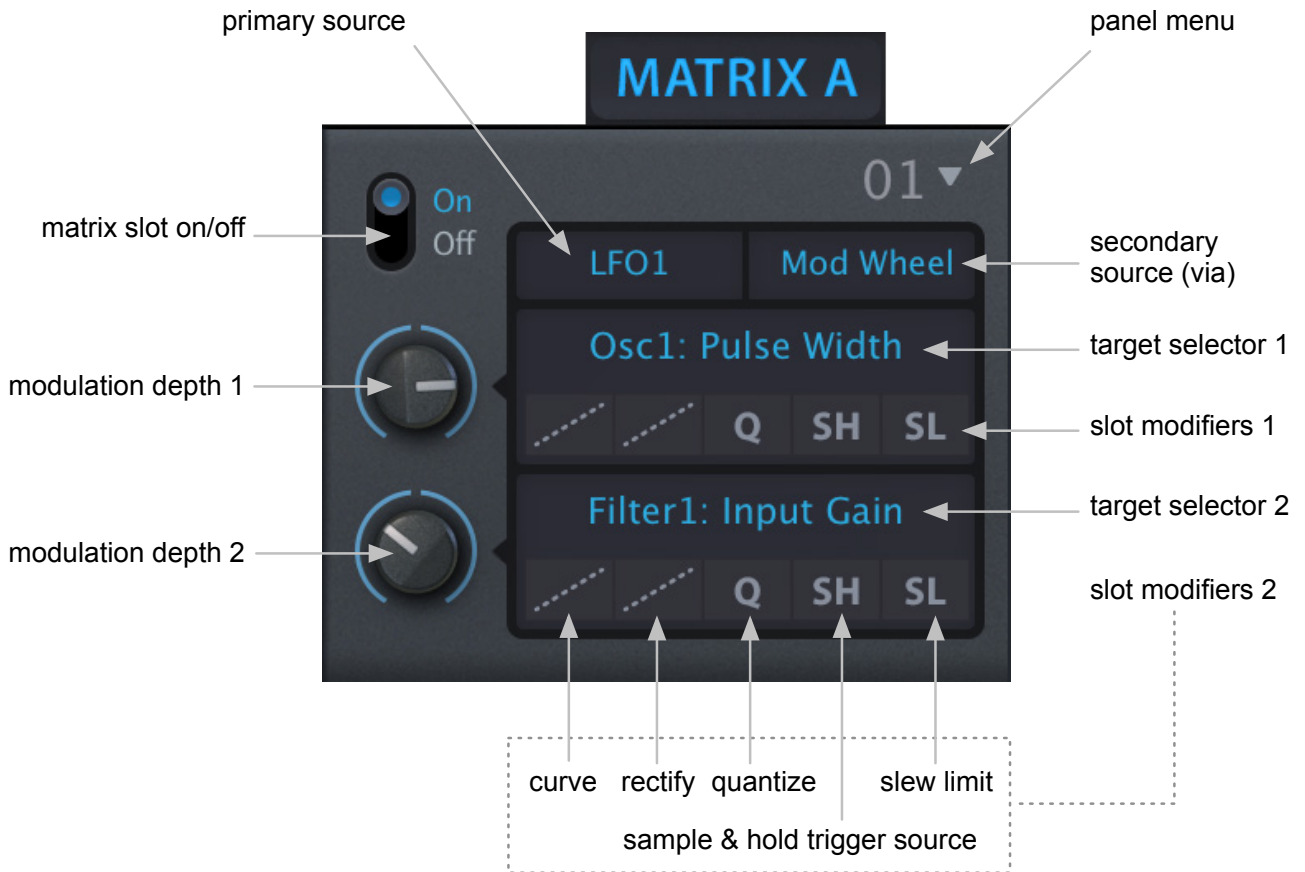

In the above example, oscillator 1 *Pulse Width* and Filter 1 *Input Gain* are both being modulated by LFO1, the depth of which is controlled by the modulation wheel (or vice versa – see *Secondary Source* below).

## Primary Source (unlabelled)

The top left selector specifies a primary modulation source. Click and select from the menu, or drag & drop from the crosshair symbols in the main panels or source buttons in the lower bar.

## Secondary Source (a “via” processor, unlabelled)

An optional secondary modulation source determines how much of the signal from the primary source is actually passed on to both targets. Click and select from the menu, or drag & drop from the crosshair symbols in the main panels or source buttons in the lower bar.

Note that the primary and secondary sources are usually interchangeable. Swapping *LFO1* and *Mod Wheel* in the above example will have the same result, although “mod wheel via LFO” may seem less intuitive than “LFO via mod wheel”.

## Target Selectors (unlabelled)

The quickest way to select a target is usually via drag & drop – see below. Alternatively you can right-click on a target selector to open a menu containing all possible target parameters. Note that inactive effect parameters will not appear in the modulation target menu – the image here shows how the menu will appear if all effects are active.

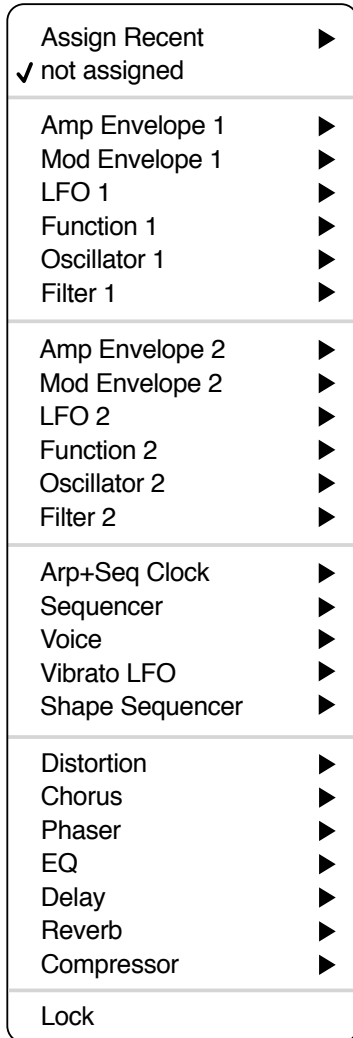

Each synthesis panel except the matrix itself has its own sub-menu – hover over an entry to see the individual targets. Note that FX parameters will only appear if the effect is active.

*Assign Recent* is a list of the most recently adjusted parameters so you can quickly assign several sources to the same target.

Immediately above the list of modulation targets is the option to remove (“unassign”) the current assignment if there is one, otherwise it will say “not assigned”, like in this image.

### Drag & Drop from a Target Selector

Hive has so many possible [modulation targets](#) that we added an easier way to get to them...

In the modulation matrix, click and hold on one of the target selectors, drag the crosshair onto a target parameter then release the mouse button. You can check whether any object is a valid target by dragging the crosshair over it: You might be surprised at some of the possibilities, especially in the FX panel or even in the matrix itself...

Not only the majority of the knobs, but also some of the selectors are valid modulation targets. Drop the crosshair onto an oscillator’s *Octave* or *Semi* selector to assign pitch modulation, onto *Phase* for phase modulation, onto the waveform for pulse width modulation if the Pulse waveform is selected, or for wavetable Position if Wavetable is selected. To modulate Delay time, drop the crosshair onto either the *Left* or *Right* selector in the Delay panel.



Remember that you can **populate the mod matrix remotely** via drag & drop from any modulator panel or from the row of modulation sources in the [lower bar](#).

## Slot Modifiers

Below each target selector is a row of buttons which can be used to modify the shape of the modulation signal, individually for each slot. They are processed in order from left to right: *Curve*, *Quantize*, *Rectify*, *Sample & Hold*, *Slew*.

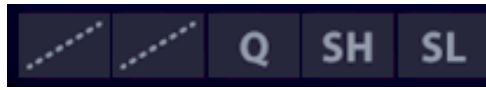

This is how they might appear when all of the modifiers are active:

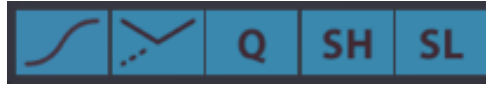

### Curve

These options let you map the source onto an s-curve – it’s like a waveshaper for modulation signals. A bipolar ramp, for instance from a rising sawtooth LFO or from the pitch bend control, would be transformed into one of these curves:

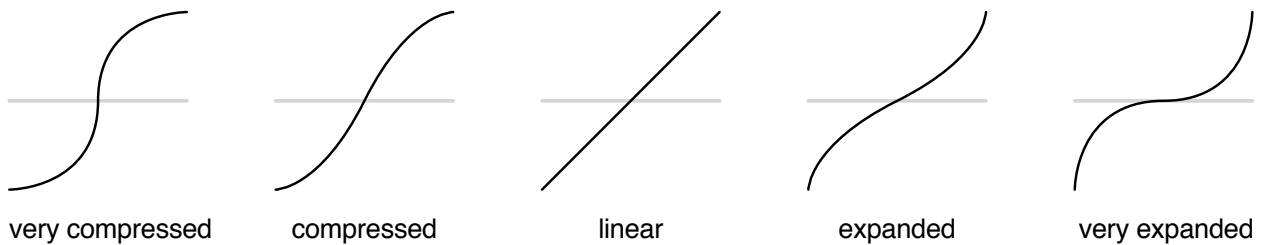

Unipolar modulation sources (envelopes, modulation wheel etc.) only use the upper half of the curve. For instance, if you want the modulation wheel to have a very subtle effect when only pushed a little, but still deliver the full effect when pushed all the way, choose *very expanded* (as the first part of the curve above zero is very shallow).

### Rectify

Half-wave or full-wave rectification (in positive as well as negative versions), or make unipolar. The symbols depict how a bipolar ramp wave would appear after rectification.

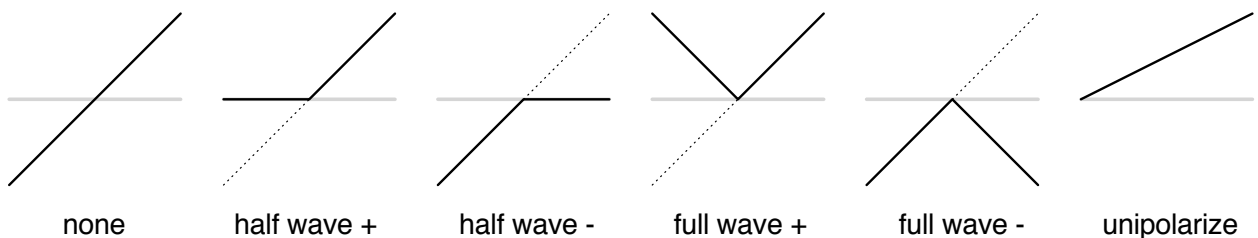

- none*.....no rectification
- half wave +*.....removes negative values
- half wave -*.....removes positive values
- full wave +*.....folds negative values up into the positive
- full wave -*.....folds positive values down into the negative
- unipolarize*.....shifts the signal to positive-only (halves the amplitude of bipolar sources)

To transform the pitch wheel so that pulling also sends positive values, choose *full wave +*.



## Quantize (Q)

After applying a curve, the modulation signal can be forced to adopt certain discrete values. The *integer* setting makes the modulation typically “steppy”, while the *steps of 12* setting transforms bipolar sources into maximum 5 values (unipolar = maximum 3) including zero.

All other options quantize the output to certain scales:

- overtone series*.....harmonic overtones
- minor / major scale*.....natural minor, regular major
- minor / major chord*.....chord tones (root, third fifth)
- minor / major series*.....third intervals (repeats after two octaves)
- fifths and octaves* .....well, it’s fifths and octaves only!

Note: As quantization is applied to the signal after the Depth control, lower Depth values mean **fewer** steps, **not narrower** steps. For instance if you quantize an LFO to *steps of 12*, you will hear no modulation at all unless you turn Depth up to at least 25.

## Sample & Hold (SH)

✓ none
LFO1
LFO2
Seq Gate
Seq Mod
Vibrato LFO
ShapeSeq A
ShapeSeq B
ShapeSeq C
ShapeSeq D
Func1 Env
Func1 Rise
Func1 Still
Func2 Env
Func2 Fall
Func2 Move
Control A
Control B
Gate
Mod Wheel
Pitch Wheel
Pressure
Random

Whenever the signal you select here crosses zero in the positive direction, the main modulation source will be sampled and held i.e. stepped.

There are fewer entries here than in the primary and secondary (‘via’) source menus. Those that make little or no sense for SH (the envelopes, Velocity, Alternate, Constant, Random, Mod Noise) have been removed.

As the Sample & Hold is applied per voice, sampled values are not retained between successive notes.

*Gate* is a particularly useful SH option as it converts the signal from the main modulation source, for instance mod wheel or LFO, into discrete steps at the onset of each note.

Note: The [Random](#) modulation source not only retriggers when a new note is played, but also whenever the option selected here crosses zero in the positive direction!

## Slew Limit (SL)

Similar to the dedicated [Glide](#) processor for pitches, the *Slew Limiter* in the matrix can be used to soften transients in any modulation source e.g. LFO square wave or Mod Noise. There is no continuous control here, but only a selector offering *off*, *fast*, *smooth* or *slow*. To develop a feel for the options, try modulating oscillator pitch from a square wave LFO with *Slew Limit* set to *slow*. Note: For technical reasons, the modulation sources *Alternate*, *Random* and *Key Follow* cannot be slewed.

Note that the [Function Generators](#) can be used as much more flexible slew limiters.

# Wavetables

The [WAVETABLE 1] and [WAVETABLE 2] buttons at the top of the hexagon open the Wavetable control pages. If you haven't selected a wavetable in the oscillator panel, you will be requested to do just that. With an active wavetable the hexagon should look something like this...



Hive wavetables can contain up to 256 single-cycle waves. Find a particular waveform by adjusting *Position*, then modulate *Position* to create tonal movement.

## Two Kinds of Wavetable

Hive can load wavetables in either of two formats, **.uhm** or **.wav**. The former is a powerful script format which creates wavetables on-the-fly by interpreting a list of text commands and formulae.

For wavetables to be recognized they must be in this location:

**Win** C:\Users\YOU\Documents\u-he\Hive.data\Wavetables\

**Mac** MacHD/Library/Application Support/u-he/Hive/Wavetables/

Files in subdirectories of the Wavetables folder will also be recognized and loaded.

For details of the **.uhm** script language and a few notes about **.wav** requirements, please refer to the extra document *Hive Wavetables.pdf* included in the Hive installer. To locate this file, click on the u-he badge and select *Docs Folder*.

**IMPORTANT:** If you get the message “File wasn’t loaded: [wavetable name]”, the wavetable’s path as stored in the preset is invalid. Be careful not to move, rename or delete wavetables if they are already in use. If you do lose factory wavetables, simply re-install Hive.

Either type of wavetable can hold up to 256 individual waveforms.

## File Selectors (unlabelled)

To load a specific wavetable, click on either of the two selectors near the top of the hexagon. The difference between them is that the arrows of the upper selector step through folders while those of the lower selector step through files. The menu also includes the following functions:

**Refresh Wavetables** updates the list, just like *refresh* does for the browser content.

**Show in Finder / Explorer** opens a system window for the currently selected folder. Important: After adding, removing or renaming wavetable files or folders outside of Hive’s own browser you will need to use the *Refresh Wavetables* function – also on the Mac.

**Unload Current** replaces the selected wavetable with the default sine wave, minimizing preset load times as well as memory and CPU usage. Once specified, wavetables will be loaded and processed *even if you replace them with regular waveforms, so...*

If you decide to use a normal oscillator type after having loaded a wavetable, remember to unload it i.e. select **Unload Current** before saving your preset!

## Info Text

Some wavetables include explanatory text while others only display the number of frames used. Try opening an .uhm file in your favourite text editor to see how they are defined.

## Position

The Position knob scans through the wavetable. This control is also available in the oscillator Waveform graphic (the POS knob).

## WT Auto Mode (unlabeled)

You can modulate wavetable Position without using an LFO or envelope etc.: One Shot scans through the wavetable just once then stops. Loop > repeatedly scans in one direction, while Loop >< scans in both directions.

Note that automatic scanning normally starts at the set Position and ends at the final wave. However, this actually depends on the status of the Reverse and Cyclic buttons (see below).

## Tempo

Adjusts the speed of One Shot or Loop modulation from “quite slow” to “very fast”.

## Reverse

Reverses the order of frames, which is particularly useful with Auto Mode *One Shot*. Try this: Load *init* (right-click on the data display), select *Wavetable* as OSC1 Wave, load *DX Piano.uhm*, from the FM folder and select One Shot. Listen to some notes, then activate Reverse... you should recognize that sound!

## Cyclic

Used in combination with Auto Mode, this option adds a copy of the first frame to the end of the table. Particularly useful for smoothing Loop >, Cyclic mode also lets loops cross wavetable boundaries. To compare, set a medium Position then switch Cyclic on and off.

## Tables < Position

Hive's wavetables become two-dimensional (some would even say three-dimensional) if the **Tables** parameter, which specifies the number of frames in the y-axis, is set to 2 or more. The lower Position knob then crossfades between frames in the y-axis. Some examples:

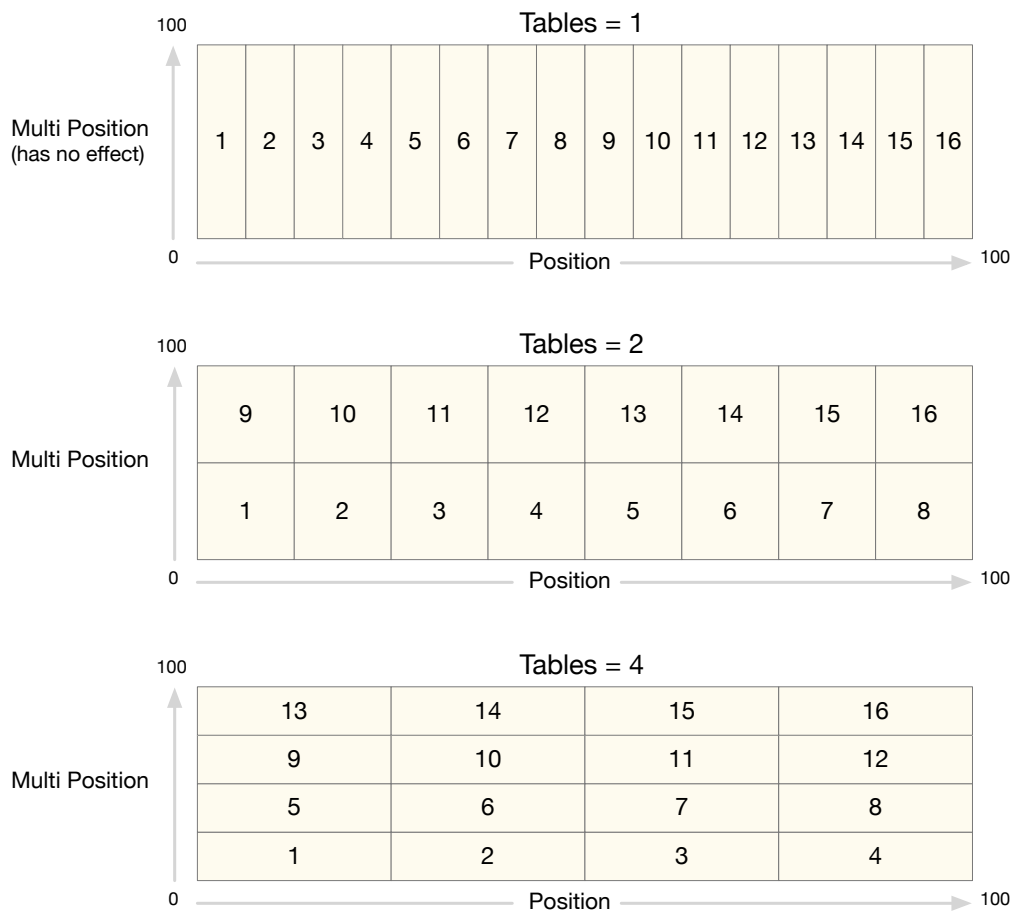

Things can get rather interesting if you set Tables to a value that doesn't divide the number of frames in the wavetable so evenly. Tip: Experiment with the Interpolator set to *switch*...

## Interpolator

A choice of 4 different algorithms for interpolating between frames. This option only applies to the main Position parameter – the interpolation through Multi Position is always *crossfade*.

*switch* .....no interpolation at all, sudden jumps between frames

*crossfade* .....smoothly interpolates waveform magnitudes

*spectral* .....like *crossfade*, but also interpolates the phases of each partial. CPU-hungry!

*zero phase* .....like *spectral*, but also forces the phase of each partial to zero first

The appearance of waveforms can differ significantly, depending on the chosen interpolation. The *spectral* and *zero phase* modes shift the relative phases of partials differently, while the *switch* option will only show the basic, non-interpolated waveforms.

As blending different phases requires extra computation, *spectral* is actually the highest quality mode, and therefore the most CPU-intensive. Tip: The CPU-friendly *crossfade* is usually best.

# Arpeggiator & Sequencer

The **ARP/SEQ** button at the top of the hexagon opens a window containing everything you need to set up complex arpeggios and sequences...



## Clock

The arpeggiator and sequencer share a common host-synchronized clock:



### Time Base

Basic note division (**1/32**, **1/16**, **1/8** or **1/4**) for the arp and sequencer. As the clock is always synchronized to host tempo, no absolute times (in seconds) are available here.

### Sync

'Strict Host Synchronization' causes arpeggios and sequences to align with beats in the host so they are not restarted with each note.

### Multiply

Speed (50% to 200%). For triplets, set 75% or 150%, for dotted times set 66.67% or 133.33%.

### Swing

Swing factor. 50% = 2:1 (triplet swing), 100% = 3:1 (dotted swing).

## Arpeggiator (ARP)

Hive's arpeggiator has the usual **octaves** and **direction** parameters, but also a few extras that make it surprisingly powerful, e.g. the ability to drive the sequencer.

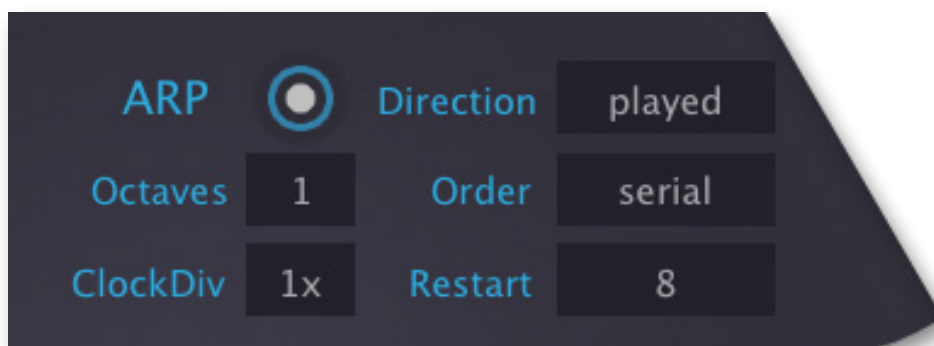

### On/Off (round button)

Activate / deactivate the arpeggiator.

## Octaves

(1 to 4) transposes the arpeggio in octaves according to the Order (see *Order* below).

## ClockDiv (clock division)

Driving the sequencer from the arpeggiator by activating both at the same time lets you transpose sequences via MIDI notes / chords. This is especially interesting if you run the arpeggiator slower than the sequencer: *ClockDiv* specifies how many times slower, from 2x to 8x.

Note: If you are using the arpeggiator on its own i.e. without the sequencer, setting ClockDiv to anything other than 1x will effectively remove any Swing (see the previous page).

## Direction

Arpeggio playback mode:

*played*.....as the notes were played

*up*.....from lowest to highest note

*down*.....from highest to lowest note

*up+dn 1* .....from lowest to highest, then back down again

*up+dn 2* .....same as up+dn 1, but the highest and lowest notes are repeated

*random*.....chaotic, unpredictable

## Order

Specifies when the arpeggio will jump to the next octave:

*serial*.....plays all notes first, then jumps octaves up

*round*.....like serial, but also jumps down again if Octaves (see above) is set to 3 or 4

*leap*.....jumps octaves at each successive note

*repeat*.....repeats the note in all octaves before playing the next note

Depending on the number of notes as well as the Octave and Restart settings (see below), some of the Direction and Order options will sound identical.

## Restart

The number of notes the arpeggiator will play before jumping back to the start. The idea behind *Restart* is to ensure that arpeggios stay in time (e.g. 4/4) however many notes are played.

Available values are **none**, **4** to **10**, **12**, **14**, **16**, **24**, **32**. Experiment with '8' or '16' first. Be aware that if you choose a very low value here, the arpeggio is likely to restart before all held notes have been played, in which case some of the notes will simply go missing.

The results of arpeggiation also depend on the selected [voice mode](#), with overlapping release phases (poly), retrigger (mono), or single trigger (legato and duo).

## Sequencer

Below the Clock and Arpeggiator panels is Hive's 16-step sequencer / modulator / gater. Here's a screenshot of the sequence used in the preset *Heavy Gravy*:



### OFF | MOD | ▶ | REC

In **MOD** (Modulator) mode the Gate, Transpose and Velocity data (see below) are ignored. The envelopes are not triggered. However, the Mod values and *Seq Gate* (see *Attack*, *Decay*, *Gate %* below) can still be used.

Select the ▶ (Run Sequencer) button if you want the sequencer to trigger envelopes. Like the arpeggiator, the sequencer will run whenever notes are played and will stop as soon as all notes are released.

**REC** (Step Record) mode lets you fill the data area with transposition, velocity and CC values, including whatever the arpeggiator is delivering.

**IMPORTANT:** The first note you record defines zero transposition (*Trsp*). To prevent notes from overshooting the transposition limits ( $\pm 24$ ), do this: Play a fairly central 'root' note first, then your complete sequence (which will also overwrite that first note), then shift the entire sequence one step to the left – see *Shift* on the next page.

### Mod CC

Specifies a MIDI controller (Control A or B, ModWheel, PitchWheel or Pressure) for recording and/or playing back Mod data (see *Mod* below).

### Dynamic Vel

When activate, the sequencer's "Vel" values are multiplied with incoming MIDI note velocities.



## Steps

The number of notes (**2 to 16**) the sequencer will play before it restarts. Tip: MIDI-learn a knob or slider on your hardware controller and try performing with this parameter!

## Shift

In hindsight, a heavily edited sequence often seems to start on the wrong beat. To fix this effect, the small triangles here rotate the active part of the sequence to the left or right. Note that Shift is only available if the sequencer is in either MOD or Run ► mode.

## Gate

Click on the dots to cycle between **Note**, **Tie** and **Rest**. Click and swipe to the left or right to change multiple steps at once.



*Note*.....Plays a note with the length defined by the *Gate %* value (see below).



*Tie*.....Like *Note* but 100% gate length. Only a true tie when in Legato [voice mode](#).



*Rest*.....The step is ignored.

## Trsp (transpose)

Per-step transposition within a 4-octave range (**-24 to +24**). Tip: Try using the mouse wheel.

## Vel (velocity)

Per-step velocity values which will override normal MIDI note velocity unless the *Dyn Vel* switch (see above) is activated.

## Mod

Use this row to modulate anything you like in sync with the sequence. These values are sent to two parallel sources: the modulation source *Seq Mod* and the chosen Mod CC (see above). We recommend using *Seq Mod* if you want to avoid the smoothing which may or may not be applied to all the Mod CC options (this depends on the [MIDI Control Slew](#) preference).

## Attack

How slowly the modulation source *Seq Gate* fades in for each step. Note that *Seq Gate* values are scaled by note velocity.

## Decay

How slowly the modulation source *Seq Gate* fades out for each step.

## Gate %

Sequencer gate time i.e. how long the notes are held relative to the clock's [TimeBase](#). Tied notes (see *Gate* above) effectively have Gate % set to maximum.

# X/Y Pads

Clicking on the [XY] button at the top of the hexagon opens a panel containing four 2-dimensional performance controls. You can set the focus to a particular control by clicking on it, by rolling your mouse wheel within the square, or by selecting from the vertical row on the right.



The buttons on the left offer 3 views: All in a single pad, as 4 separate pads or as 8 knobs.



At the bottom of the hexagon in the pad views are labels for each individual X and Y control, while in the 8-knob view they appear next to each knob. Double-click on a label to edit the text (maximum 20 characters). The macro itself will not be affected – that’s what the [EDIT] buttons are for!

## XY Macro Assignment

Whenever a preset is loaded that doesn’t include XY control, Hive can automatically create it for you. These “macros” affect up to 4 parameters simultaneously, and each pad offers a different set: Oscillators or Control A/B values (XY1), filters (XY2), envelopes or LFOs (XY3) and effects (XY4). See the option [XY Auto Setup](#) in the Preferences panel.

Right-click anywhere on the pad to open the **XY macro menu**:

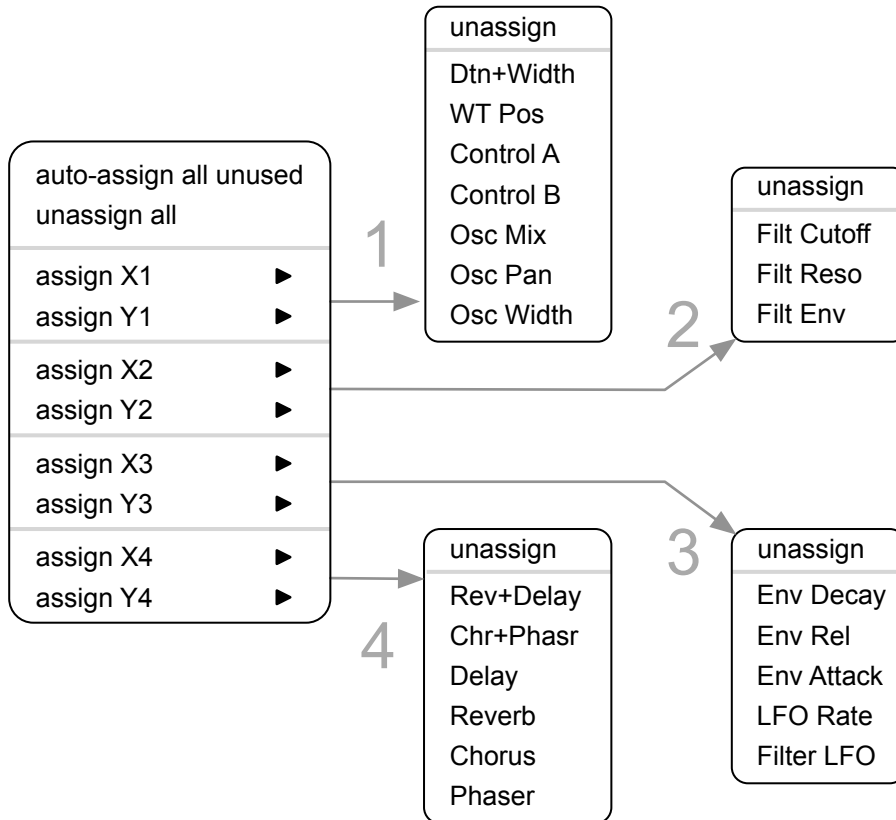

Select *auto-assign all unused* to assign any unassigned X and Y controls. Caution: The *unassign all* function removes all XY assignments from the preset, and this cannot be undone.

Each X and Y control has a sub-menu containing preset macros. These are the same for X and Y but different for each pad (1-4). Select *unassign* to remove the existing assignment.

The *Control A/B Offset* options (available for XY pad 1 only) let you send [CC data](#) from the pad via the [modulation matrix](#) to multiple Hive parameters. Being an offset, this is **added** to any Control A or B data received from elsewhere e.g. from Hive’s sequencer or from an external CC source.

## XY Custom Assignment

For more flexibility, each X/Y pair has its own modulation matrix panel where you can specify up to 4 target parameters and modulation depths. These panels are opened either by clicking on an [XY] button in the lower bar or on an [EDIT] button below the XY pad:

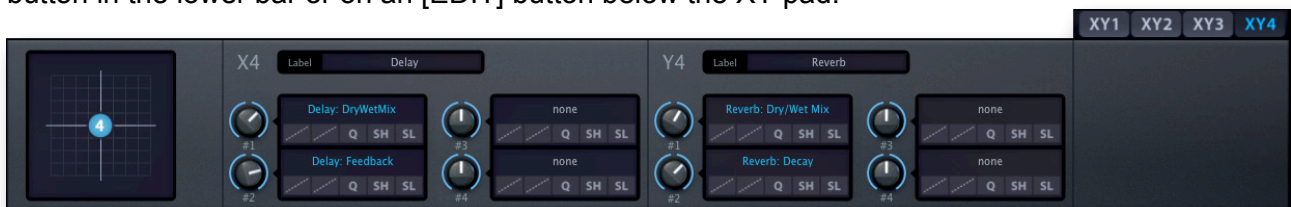

On the left is a small XY pad so you can test your settings immediately. As mentioned above, each X and Y dimension has its own label. Double-click to enter maximum 20 characters. NKS users please note that fewer will be displayed on the hardware.

Like the general purpose modulation matrix, the XY matrix also has [slot modifiers](#) *Curve*, *Quantize*, *Rectify*, *Sample & Hold* and *Slew*. For details, see the section about the [modulation matrix](#).

# Effects (FX)

The [FX] button at the top of the hexagon opens a window containing everything you need to set up a complex chain of audio effects:



**Important:** The symbol to the right of the [FX] label is a global on/off switch for all active effects. Disable it and you won't hear any effects at all, even after changing presets!

## Enable / Rearrange

The central column contains 7 buttons, one for each effect. Click to switch the effect on or off. Click and drag up or down to change the order of effects.

Tip: Experiment with unusual orders, for instance reverb then phaser followed by distortion!

## Distortion

Hive's distortion unit is powerful but relatively simple, requiring only a mode selector and 3 knobs...



### Mode (unlabeled)

*Soft Clip* ..... Smoothly compresses peaks in the signal.

*Hard Clip* ..... Simply chops off the top and bottom of the waveform.

*Foldback* ..... Similar to soft clip except that increasing the gain doesn't slam more of the signal peaks against the limits, but reflects (folds) them back.

*Corrode* ..... A combined sample rate and sample resolution control (a.k.a. bit crusher). The *Amount* and *Tone* controls (see below) are replaced by *Rate* and *Crush*.

### Amount

Input gain control. This effectively sets a threshold above which distortion occurs (and therefore the perceived amount of distortion). In *Corrode* mode (see above), this knob sets the amount of sample rate reduction (the label changes to **Rate**).

### Tone

Bipolar frequency tilt for more bass or treble distortion. In *Corrode* mode (see above), this knob reduces the sample resolution (the label changes to **Crush**).

### Mix

Dry/Wet balance control. Turning Mix down from the usual maximum preserves more of the original character without affecting the distortion characteristics.

### Rate (in Corrode mode)

Replaces the Amount knob. Reducing / decimating the sample rate degrades audio quality: Low values introduce high-pitched grit. At high Rate values, aliasing takes over i.e. you will hear more rough metallic tones than you will hear original signal.

### Crush (in Corrode mode)

Replaces the Tone knob. Bit crush / resolution reduction. Waves become increasingly steppy until they become clicks or even silence, depending on the input signal.

## Reverb

Hive's plate reverb unit is surprisingly flexible. It is capable of anything from small resonators (e.g. guitar body or metal tubes) to huge cathedrals...



### Pre

A single delay before the reverb starts. Especially useful for retaining the presence of the original signal while using lots of reverb. Or as a slap-back delay!

### Size

Room dimensions, from sardine can to infinity and beyond. Balance this with Decay...

### Decay

Controls reflectivity of the room, essentially the opposite of Damp (see below). Affects how long it takes for the reverb tail to fade out.

### Damp

Causes higher frequencies to fade out more quickly than low frequencies, imitating the 'warming' effect of carpets, curtains etc. in a room, or the audience in a concert hall.

### Tone

Strong 'tilt' equalizer. Use in combination with Damp to colour the reverb.

### Width

Stereo spread of the 'wet' signal. Note that adjusting this parameter does not affect the stereo width of the input signal, as the processed portion is summed to mono first.

### Mix

Balance between the original (dry) and reverb signals. At maximum, the dry part of the signal is faded out completely, which lets you use Hive's reverb for strong 'guitar body' type resonances: Set Pre to minimum, and fine tune the Size around 5.00.

### Pan (hidden parameter)

Reverb pan position. Usually modulated with Constant or any mod source that is not per-voice.

## Equalizer

Insert the EQ effect wherever you want to cut or boost parts of the spectrum.



### Bass | Mid | High

Hive's 3-band EQ effect comprises low and high shelving filters surrounding a fixed-width mid frequency band. Each band has a cutoff frequency (Freq.) control, and the corresponding Gain controls let you set anything between -15dB and +15dB.

Tip: Where you place the EQ in the effects chain can be decisive. For instance, position the EQ after the Distortion unless the plan is to control distortion characteristics with it.

## Chorus

Chorus has a long tradition as synthesizer effect – after spring reverb, it was the second effect to be built into a commercial synth. Hive's Chorus unit offers three different models that share a common set of controls:

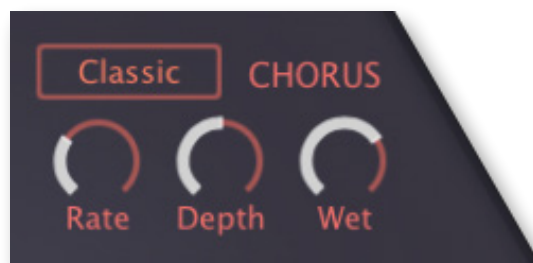

### Type (unlabelled)

*Classic*, *Dramatic* and *Ensemble* are all based on well-known hardware effects of yesteryear. The latter is especially rich: it can turn a raw oscillator into a classic 'string machine' sound.

### Rate

The modulation speed. Use low values for slow stereo effects.

### Depth

The modulation amount. Set to zero (with *Classic* or *Dramatic*) for static coloration.

### Wet

Balance between the original and treated signal. Lower values here can be used to add warmth without making the sound too 'washy'.

# Phaser

---

Traditional sweeping effect, stereo, with adjustable resonance (feedback)...



## Rate

Modulation speed of the Phaser's own LFO.

## Feedback

The amount of resonance. Note: high resonance can create strong bass humps.

## Flanged (button)

Switches from the default *Stoned* mode to the alternative *Flanged*. As it uses more delays, *Flanged* is more resonant and is particularly suitable for bright sounds. *Stoned* mode is arguably more 'psychedelic'. Both models are based on classic hardware stomp-boxes.

## Stereo

A bipolar stereo width control. Note that with the 'Stoned' type, maximum stereo width is at +/- 25.00 (this is especially obvious if you turn Feedback way up).

## Phase

LFO phase offset, from 0 to 360°.

## Wet

Amount of phase-shifted signal, from 0% (completely dry) to 50% Wet.

## Depth (hidden parameter)

The amount of modulation from the Phaser's own LFO. Normally maximum.

## Center (hidden parameter)

Phase offset. For static colouration effects, load the matrix [panel preset 11 Phaser Flattener](#).



# Compressor

---

Although dynamic processing is useful in any audio system, compressors are not often found built into synthesizers. The number of controls in Hive's compressor has been reduced to a minimum...



## Amount

An inverted **threshold** and compression **ratio** control in one. At higher values, it can get loud...

## Out

Turn this down to compensate for the boost in volume caused by strong compression, or turn it up to boost very quiet signals (set the Amount to zero).

## A

Attack: How fast the compressor reacts to peaks in the signal. Experiment with Attack and Amount for maximum 'punch' in percussion sounds, or for the smoothest pads.

## R

Release: Compression 'relaxation' time. This setting isn't quite as important as attack because the actual release time is semi-automatic.

## GR (Gain Reduction)

How much the signal level is being reduced whenever the compressor kicks in. For maximum effect, make sure there is plenty of movement here.

## Mix (hidden parameter)

Dry/Wet mix control for parallel (a.k.a. New York) compression. See [hidden parameters](#).

## Delay

Hive's delay unit looks simple enough, but is very 'musical'...



### L and R

Independent delay times for the left and right channels, always synchronized to host tempo. 'T' in the menu means triplet time (3 in in the space of 2) and 'D' means dotted (half as long again).

Tip1: For typical extreme stereo, set the right channel to twice as long as the left e.g. 1/4 and 1/2. Generally set Ping-Pong mode if the left channel's delay is shorter, otherwise Pong-Ping.

Tip2: For a fuzzy slap-back effect, set the delay times to 1/32 and 1/16T, turn *Feedb* down to zero and *Diffu* up to maximum. You can make the delay times even shorter by negatively modulating the hidden parameter *Delay / Time Scale*. See [hidden parameters](#).

### Mode (unlabeled)

*Stereo* .....independent delays without any cross-feed from one channel to the other

*Ping-Pong* .....feeds the left channel into the right, then vice versa

*Pong-Ping* .....feeds the right channel into the left, then vice versa

### LP and HP

Cutoff controls for lowpass and highpass filters within the feedback path. Lower the value of LP for typical damping, increase HP to reduce bass and mid frequencies.

### Width

Stereo width of the delay signal.

### Feedb

Feedback / regeneration amount. The output signals are fed back into the input for repeating echoes. 100.00 will give you an almost infinite loop if LP is set to maximum and HP is set to minimum... so try that!

### Diffu (diffusion)

The diffusion parameter makes the delay more 'fuzzy'. When Diffu is set to maximum, individual echoes sound almost as if they had been treated with a short reverb.

### Mix

Balance between dry signal and treated signal.

### TimeScale (hidden parameter)

Modulate this parameter to shift all delay times away from strict synchronization. Simply drag & drop a modulator onto the **L** or the **R** selector, then adjust the amount in the modulation matrix.

**Wow** (hidden parameter)

'Wow' emulates the low frequency wavering of old magnetic tape delay units. To adjust the amount of Wow, use Constant as source in the modulation matrix (and of course select Delay / Wow as your target).

Tip: In the Matrix is a [panel preset](#) called '09 UnWow the Delay'. This sets Wow to zero and lets you straighten the delay time, which was set slightly longer to avoid overly robotic delays. As this depends on the delay length, you may have to adjust the upper modulation amount.

**Pan** (hidden parameter)

Overall Delay pan position. Modulate with Constant or any other source that isn't "per voice".

## FX Preset

---

At the bottom of the hexagon is a [panel preset](#) button in the form of a selector which you can use to copy/paste, save or load all FX settings at once. Unlike the small panel preset buttons in other Hive panels, this one displays the panel preset's file name.



# Scope

Animated graphics in software synthesizers not only look cool, but can also help you program your sounds by showing you what's happening in real time. Hive's Scope is especially useful for displaying how the parts of complex modulation interact (e.g. the [Function Generators](#) with an LFO).



As audio output is common to all presets, **stereo audio** is the default view. The above screenshot shows a mono sum of the audio as well as the output of a modulation matrix slot.

To zoom horizontally, adjust the blue handles and the connecting line. As usual, hold SHIFT for a finer resolution. If maximized, the view will scan (like a heart rate monitor) and smoothly adjust the automatic normalization whenever there is a significant change in volume.

You can drag & drop any modulation source or even the target field of a matrix slot into the central area to view the signal in realtime. The audio view will switch to a mono sum to make room for the new source, and will disappear if you want to view 2 or more modulation signals.



If you drag & drop any modulation source onto one of the 4 fields at the bottom of the hexagon, or right-click there and select from the menu, you can specify the vertical order. To remove a signal from the Scope, click on its box and select *none*.



The pair of small icons immediately below the SCOPE tab lets you switch between 4-colour and monochromatic viewing.



The [**Freeze**] button at the bottom right of the hexagon displays a motionless snapshot of the current state of the data in the scope. Click again to “thaw”.

Right-click anywhere in the display area to set *eco* (CPU-friendly), *fast* or *glow* view mode.

# Configuration



The cogwheel button at the top right opens the **global configuration** pages where you can adjust the window size and brightness or connect Hive parameters to MIDI continuous controllers.

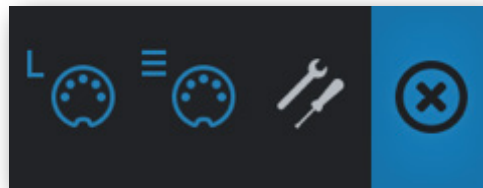

The 4 buttons are MIDI Learn [L], MIDI Table [≡], Preferences [tools] and Close [X]:

## About MIDI CC

Before connecting knobs and sliders on your master keyboard to Hive parameters (see the next page), it's best to know what a **MIDI CC** is...

**CC**, which officially stands for **Control Change** now (it used to mean “Continuous Controller”), is a multi-purpose message format for performing as well as editing presets.

Note that CC isn't the only kind of MIDI performance data available; there are also messages for note on/off (including velocity), pitch bend and two kinds of aftertouch.

Thankfully, the MIDI Manufacturers Association (MMA, a.k.a. [MIDI Association](#)) left most of the CC numbers undefined, but two of them have specific meanings which are also recognized by Hive:

- CC#01 = modulation wheel
- CC#64 = sustain pedal

Hive version 1.0 also offered modulation sources called *Breath* (CC#02) and *Expression* (CC#11). These have been replaced by the user-definable *Control A* and *Control B*. See the [Preferences](#).

Later revisions to the MIDI spec even included a bunch of overly specialized CC definitions such as *Celeste Detune Depth* – presumably at the bidding of a home organ manufacturer or two. We can safely ignore all those names.

You don't need a hardware breath controller or expression pedal to make use of CC messages! Most of the MMA-specified names are little more than convention: You can use anything that can send CC messages, for instance a knob or slider on your MIDI keyboard, or a controller lane in your MIDI sequencer.

# MIDI Learn



The **MIDI Learn** page is where you can connect MIDI CC (see above) to most Hive parameters. CC data can be generated by e.g. knobs on your hardware controller, or by a track in your host sequencer. Click on the configuration button and select the 'L' MIDI icon (looks like a 5-pin DIN socket).

The window is a translucent overlay, with all MIDI-learnable elements appearing as selectable out-lines. Already connected controls are filled (like three of the filter knobs in this image), and the outline of the currently active control is highlighted (like FILTER 1 *Mod Env* here).

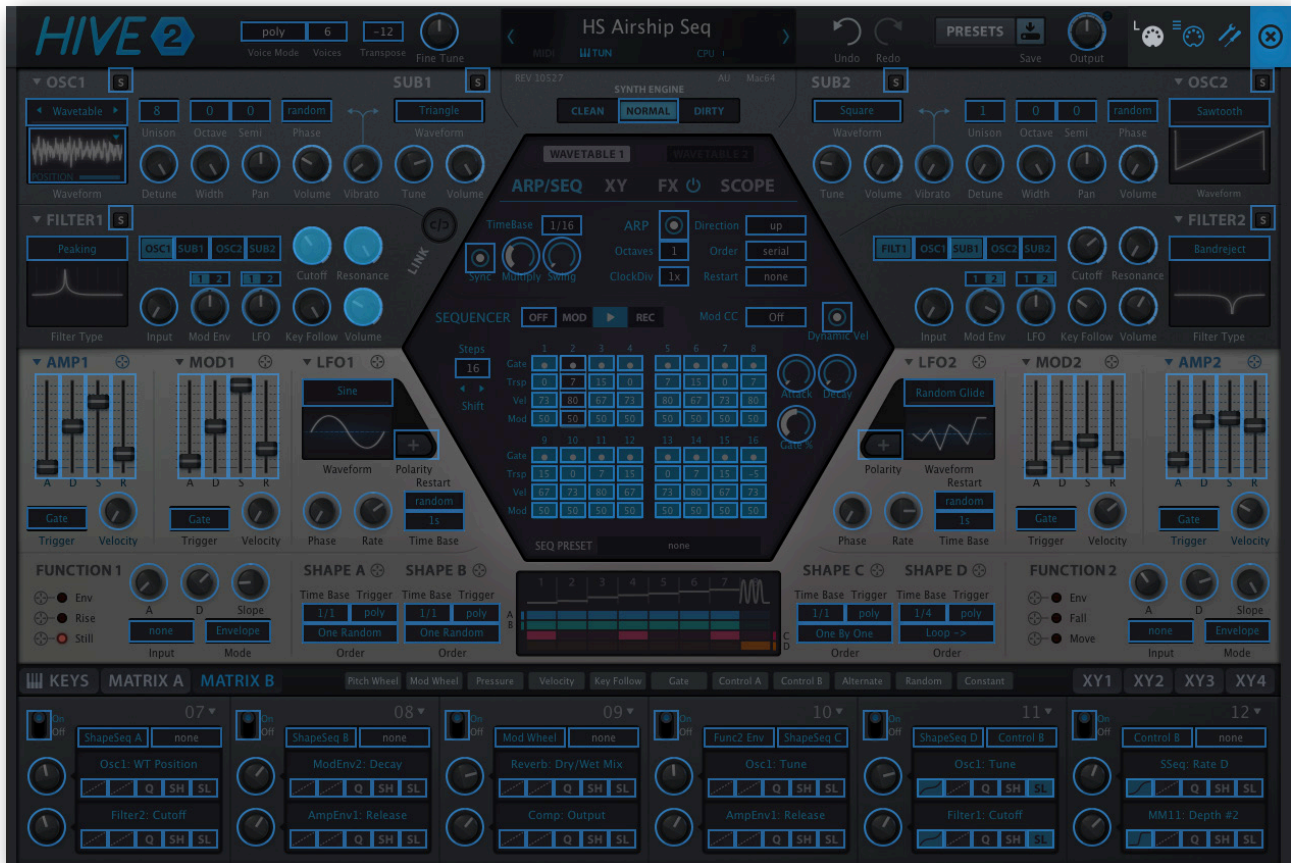

Try it: Click on the FILTER 1 Cutoff knob and send it some MIDI CC data (wiggle a knob or slider on your MIDI controller). To remove the new CC connection, double-click on the same knob.

Note: Controls within currently invisible panels will not be immediately available i.e. they cannot be switched over from within the MIDI Learn page: Exit the configuration pages, select e.g. ARP/SEQ, Wavetable, FX etc., then navigate back into the MIDI Learn panel.

All assigned controls will appear as a list in the MIDI Table page (see the next page)...

# MIDI Table

Click on the configuration button (cogwheel) and select the MIDI icon labeled '≡':



## Parameter

The field selects one of Hive’s parameters, sorted into sub-menus. Click on the [ADD] button at the bottom and experiment! Afterwards, delete the line by clicking on the [X] to the right.

**An experimental feature:** Select *Last Clicked Control* from the bottom of the Parameter menu, enter any controller number then exit the configuration pages. Any MIDI controllable knob or switch in Hive will now respond to that controller – you just have to click on it first! The final option, *Last Clicked Control Fine*, is similar but with a significantly reduced range.

## Channel / Controller

The next two fields are for MIDI channel and CC number. Hive is channel-sensitive so you can map up to 16 channels for a total of about 2000 control assignments. Should be enough!

## Mode

Specifies the range / resolution of values. The last 2 options are for adjusting oscillator pitch

- normal* .....full range, continuous
- integer* .....full range, whole numbers only
- fine* .....0.01 steps between the two integers closest to the current value
- octaves* .....max. 5 discrete values
- semitone* .....+/- 6 semitones, continuous

## Type

Specifies the type of hardware. By far the most common is *Continuous 7-bit*.

- Encoder 127* .....‘relative mode’ endless rotary controls that repeatedly send the CC value  
1 when turned up, or 127 (interpreted as -1) when turned down
- Encoder 64* .....‘relative mode’ endless rotary controls that repeatedly send the CC value  
65 when turned up, or 63 when turned down
- Continuous 7-bit* .....7-bit MIDI CC (normal resolution, common)
- Continuous 14-bit* .....14-bit MIDI CC (high resolution, rare)

## Remove

To remove individual assignments, click on the [x] to the right of each line. To remove them all at once, click on the [Delete All] button at the bottom of the window. See 2 pages down...

## Per Instance Control

Local versions of the Control A Default and Control B Default settings in the Preferences page.

# Preferences Page

Click on the 'tools' icon to access the global options...

## CONTROLS

### Mouse Wheel Raster

If your mouse wheel is rastered (you can feel it clicking slightly as you roll the wheel), set this option to 'on' so that each little click increments the value in sensible steps.

### Preset Scrolling

Direction of scrolling within the [presets panel](#).

## APPEARANCE

### Default Size

The GUI size for each new instance. You can temporarily change the GUI size without opening the Preferences page by right-clicking anywhere in the background.

### Default Skin

Sets the selected skin as the global default. Will not appear if none are available.

### Gamma

Effectively Hive UI brightness. It might take a moment before the new setting appears.

### Text Antialiasing

Smoothing of labels and values. Normally left on – only in special cases will switching it off improve readability.

## PRESETS

### Auto Versioning

If switched on, an index is appended to the preset name and automatically incremented each time you save it. For instance, saving 'Space' three times in a row would give you three files: 'Space', 'Space 2' and 'Space 3'.

### Save Presets To

The *user folder* option prevents Hive from saving presets into the Local folder. Instead, they will land in the User folder (or a subfolder if selected).

### Scan On Startup

Whether the preset library should be scanned and the database recreated when the first instance of Hive is started, e.g. when you reopen a project.

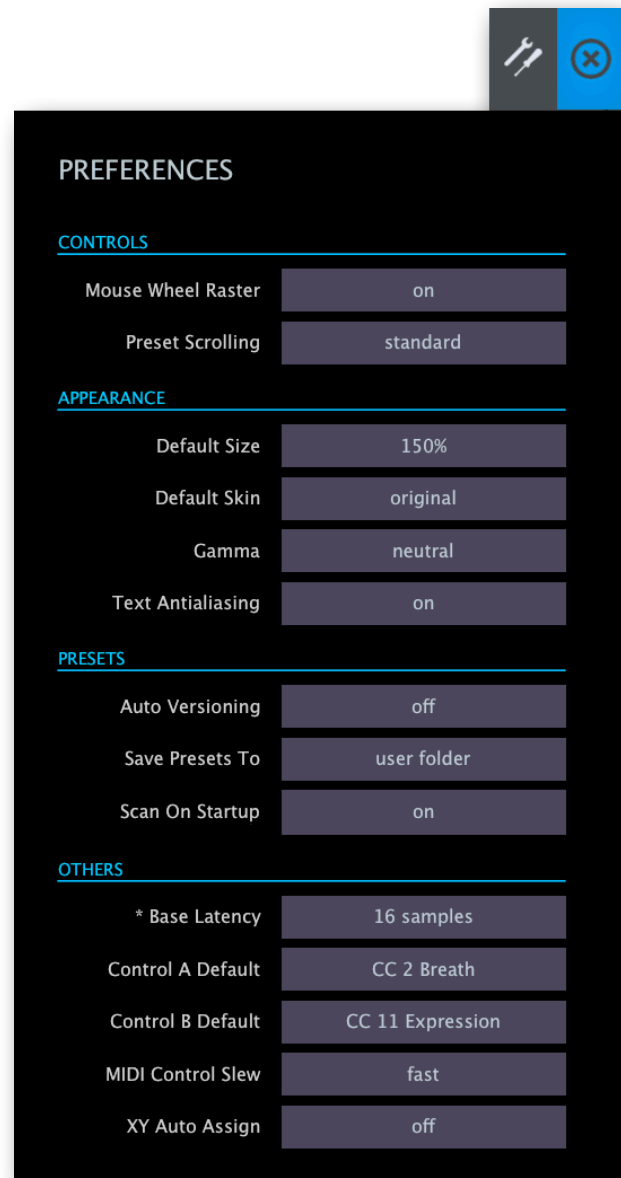



## OTHERS

### Base Latency

If you are certain that your audio system – hardware as well as software – uses buffers that are a multiple of 16 samples in size (please refer to the appropriate documentation), you can safely disable Hive’s base latency. Otherwise leave it set to the default *16 samples* to prevent crackles.

A new *Base Latency* setting will only take effect when the host allows e.g. on playback or after switching the sample rate. Reloading Hive also works.

#### ABOUT THOSE BUFFERS

Internally, Hive processes audio in chunks of  $n \times 16$  samples. This ‘block processing’ method significantly reduces the CPU load and memory usage of all our plug-ins.

If the number of samples to be processed is say 41, Hive processes the first 32 and keeps the remaining 9 in a small buffer (16 samples is enough). Those 9 samples are then processed at the start of the next call... and so on.

The extra buffer is only necessary if the host or audio driver processes ‘unusual’ buffer sizes. In the many host applications that process buffers of e.g. 64, 128, 256 or 512 samples (all multiples of 16), try switching it off so that Hive can process latency-free.

### Control A/B Default

Apart from the modulation wheel, the list of modulation sources in the previous version included two extra fixed MIDI controls: *Breath* (CC#02) and *Xpress* (CC#11). While retaining backwards compatibility, we have replaced those with the user-definable *Control A* and *Control B* sources.

### MIDI Control Slew

Determines the strength of parameter smoothing for the following performance controls: pitch bend, modulation wheel, Control A, Control B and Pressure. With *MIDI Control Slew* set to ‘off’, Hive is more responsive to modulation wheel data (for instance), but can sound rather grainy. The default setting (‘Fast’) is a good compromise between speed and smoothness.

The ‘Slow’ option is adaptive: Whenever the incoming control data jumps suddenly between values that are further apart, the slew is not applied.

### XY Auto Assign

Specifies whether / how unused XY pad dimensions will be automatically assigned whenever a preset is loaded:

*off* .....do not auto-assign

*all unused* .....auto-assign all unused dimensions

*if none* .....only auto-assign if the preset has zero XY assignments

# Inside the Hive

## Matrix Sources

Here is a list of all modulation sources available in the [modulation matrix](#). Note that it does not include the [X/Y pad](#) controls, as these have their own dedicated matrix.

Internal sources	
Amp 1/2	amplifier envelopes
LFO 1/2	low frequency oscillators
Mod 1/2	modulation envelopes
Seq Gate	the sequencer's gate (adjust Attack / Decay!), scaled by velocity
Seq Mod	sequencer <i>Mod</i> data
Vibrato LFO	global low frequency oscillator (not only for vibrato!)
ShapeSeq A-D	the four parts of the shape sequencer
Func1 Env	function 1 envelope signal
Func1 Rise	function 1 gate opens during the attack phase(s)
Func1 Still	function 1 gate opens while motionless
Func2 Env	function 2 gate opens during the attack phase(s)
Func2 Fall	function 2 gate opens during the decay phase(s)
Func2 Move	function 2 gate opens during attack and decay phases

MIDI sources	
Control A	user-definable CC - default is Breath (CC#02)
Control B	user-definable CC - default is Expression (CC#11)
Gate	+100 while a note is played, otherwise zero (see numeric sources)
Key Follow	value derived from MIDI note number, pivots around 'E3' (note 64)
Mod Wheel	modulation wheel (CC#01)
Pitch Wheel	pitch bender
Pressure	aftertouch (channel pressure or poly pressure)
Velocity	MIDI note-on velocity

Numeric sources	
Alternate	alternating extreme (+100, -100, +100, -100 etc.) per note
Random	random value anywhere between -100 and +100 per note can also be retriggered by SH in the modulation matrix
Constant	+100
ModNoise	Noise as modulation source!

## Matrix Targets

Here is a list of all modulation destinations available in the [modulation matrix](#). To the left is what you see in the target selector's context menu, to the right is what you see in each sub-menu.

Targets in bold typeface are [hidden parameters](#) (see the next page). These are only available in the modulation matrix and do not have controls in the panels.

Synthesis targets	
Amp Envelope 1/2	Attack, Decay, Sustain, Release, Velocity
Mod Envelope 1/2	Attack, Decay, Sustain, Release, Velocity
LFO 1/2	Phase, Rate
Function 1/2	Attack, Decay, Slope
Oscillator 1/2	Detune, <b>Tune</b> (continuous), Vibrato, <b>Phase</b> (angle), <b>PulseWidth</b> (pulse only), Volume (main oscillator), Pan, Width, Sub Tune, Sub Volume, WT Position, WT Tempo, WT Multi Pos, In Scale Transpose
Filter 1/2	Input Gain, Cutoff, Resonance, Key Follow, Env Depth, LFO Depth, <b>Spread</b> , Volume, Damp, Ratio, Mix
Mod Matrix	Depths. Drag&drop only i.e. not visible in the menu

Global targets	
Arp+Seq Clock	Multiply, Swing, Attack *, Decay * and Gate % *
Voice	Glide
Vibrato LFO	Delay, Rate
Shape Sequencer	<b>Rate A-D</b> , Left Value (A), Right Value (B), Curve (C), Ratchet (D), <b>Position A-D</b>

\* *Attack*, *Decay* and *Gate %* are only available via drag & drop. They do not appear in the menu.

Effect targets	
Distortion	Amount, Tone, Mix, Rate, Crush
Chorus	Rate, Depth, Wet
Phaser	Rate, Feedback, Stereo, Phase, Wet, <b>Depth, Center</b>
EQ	Bass Gain, Bass Freq, Mid Gain, Mid Freq, High Gain, High Freq
Delay	<b>Time Scale</b> , Width, Dry/Wet Mix, Feedback, HighPass, LowPass, <b>Wow</b> , Diffuse, <b>Pan</b>
Reverb	Pre-Delay, Damp, Decay, Size, Tone, Width, DryWetMix, <b>Pan</b>
Compressor	Amount, Attack, Release, <b>Mix</b> , Output

## Hidden Parameters

To avoid cluttering Hive's UI with too many controls we decided to make certain parameters only available within the modulation matrix. If you simply want to offset values (e.g. the basic pulse width of an oscillator or the delay time), use *Constant* as modulation source.

*Oscillator Tune* (continuous)

*Oscillator Phase*

*Oscillator Pulse Width*

*Filter Spread*

*Shape Sequencer Rates*

*Shape Sequencer Positions* (practically "segment phase")

*Delay Time Scale*

*Delay Wow*

*Delay Pan*

*Reverb Pan*

*Phaser Depth*

*Phaser Center*

*Compressor Mix*

One useful side-effect of hidden parameters is that we can add as many modulation targets for the experts as we like without making Hive harder to use for beginners.

## MIDI Specialities

---

### MIDI Programs

All presets (up to 128) present in this folder will be loaded into memory when the first instance of Hive starts. 'MIDI Programs' can then be switched via 'Program Change' messages. As MIDI Programs are accessed in alphabetical order it makes sense to prefix each name with an index '000 rest-of-name' to '127 rest-of-name'.

**IMPORTANT:** Unlike regular presets, MIDI Programs can't be added, removed or renamed on the fly. Changes will only take effect after the host software is restarted!

The MIDI Programs folder can contain up to 127 sub-folders of 128 presets, switched via MIDI 'Bank Select' messages (CC#0) preceding the Program Change message. The MIDI Programs folder itself is bank 0, sub-folders are addressed in alphabetical order starting with bank 1.

When Hive receives a program change, it will display the bank and program numbers to the left of the preset name e.g. "0:0" for the first preset in the first bank. In certain hosts, however, the first bank / preset is designated "1" instead of the correct "0".

To avoid another possible source of confusion, make sure that there are no junked presets in the MIDI Programs folder. All files there are addressed, even if they are hidden.

### Poly Pressure (polyphonic aftertouch)

Hive recognizes polyphonic aftertouch data – each voice is modulated independently.

### Multichannel MIDI

All u-he synthesizers support a growing class of highly expressive, sensor-based instruments (e.g. Haken Continuum, Eigenharp, Roli Seaboard, Linnstrument) that are capable of sending each note over its own MIDI channel. For Hive to respond correctly, your host must be capable of routing multiple MIDI channels to a single plug-in instance: This is not yet standard!

While Hive is receiving multi-channel MIDI data, each voice will respond independently to the following control messages: Pitch bend, Pressure (aftertouch), Modulation (CC #01) as well as Control A and Control B as defined in the global Preferences or the MIDI Table page.

The [voice modes](#) **Poly**, **Mono** and **Legato** become practically identical. In each case, Hive behaves like several (up to 16) mono synths set to the same sound. Note that the **duo** voice mode isn't channel-aware i.e. all MIDI channels are merged.

### MTS-ESP

Hive now supports [Oddsound MTS-ESP](#), a system for microtuning multiple plug-ins within a DAW environment. The freeware 'Mini' version is all you need to get started. MTS-ESP can be overridden by activating Hive's own microtuning, for instance with the .tun file *Default Scale*.

# NKS

Hive 2 supports Native Instruments **NKS** format so it can be integrated into the Complete Kontrol software or Maschine environments: The factory presets can be installed as tagged .nksf files, and the XY pad settings are transferred to the first NKS Parameter Page in the Control Area.

## Saving as .nksf is only possible in the VST2 version

Mac owners can use – temporarily if necessary – any host application that supports VST2

## Saving in NKS format

While the *native*, *h2p* and *h2p extended* options cause Hive to save presets into the currently selected preset directory, *.nksf* files go directly into the preset location used for Complete Kontrol or Maschine. They do not appear in Hive's preset browser. To make them visible in Complete Kontrol, open its preferences and rescan the preset locations.

## Batch conversion

First, right-click the [Save] button and set the target format to *nks*. Via cmd+click (Mac) or alt+click (Win), select all presets in the current folder you want to convert, right-click any of the selected presets and choose *Convert to nks* from the menu. The original files will not be affected.

## What to do if Hive doesn't show up in Complete Kontrol / Maschine.

First of all, make sure that your NKS software is up to date: Complete Kontrol V1.5+ or Maschine V2.4 are the minimum requirements.

In Windows, Complete Kontrol must know the location of the folder containing Hive: Open the Complete Kontrol preferences, go to *Locations* and add that path (if necessary), hit Rescan and check whether Hive appears.

Maybe the NKS preset folder is empty? If so, please reinstall Hive with the correct VST path and the NKS-option checked.

The preset folder locations are:

**Mac:** *Macintosh HD/Library/Application Support/u-he/Hive/NKS/Hive/*

**Win:** *C:\Users\YOU\Documents\u-he\Zebra2.data\NKS\Hive\*

Perhaps the XML-File is missing from here:

**Mac:** *Macintosh HD/Library/Application Support/Native Instruments/Service Center/u-he-Hive.xml*

**Win:** *C:\Program Files\Common Files\Native Instruments\Service Center\u-he-Hive.xml*

A re-install with the NKS-option checked should also remedy this issue.

## What to do if Complete Kontrol / Maschine is unable to load Hive

Either Hive wasn't installed as VST2, or it wasn't installed with the correct path. The default VST path is fixed in MacOSX, but in Windows it can be freely assigned during installation:

**Mac:** *Macintosh HD/Library/Audio/Plug-Ins/VST/u-he/*

**Win:** *<User VST Folder> / (path for the VST plug-in set during installation)*

If Hive's VST plug-in cannot be found in one of these locations, run the installer again making sure that you set the correct path and have activated 'VST' as installation option.

# Tips & Tricks

This chapter lists a few less obvious tricks you can apply to your own creations - enjoy!

## Setting Volumes

---

- There are several points within the signal path where levels are affected: Oscillator volume, filter input and output volumes, amp envelope velocity, compressor amount, compressor output, main output. Which of these you choose to adjust the overall level can and will affect the sound!

For more information on this subject, search for “gain staging” in the Internet.

## 432 Hz Tuning

---

- Instead of the standard 440Hz, tuning A4 to 432Hz has become inexplicably popular recently. To retune Hive to 432Hz, set FINE TUNE to precisely **-31.76** (using SHIFT), right-click on that knob and **lock** it. Of course this assumes that you haven't already used *Fine Tune* in your presets.

## Using Constant

---

- To fine tune an oscillator while Unison is set to 2 or more, grab Constant from the lower bar and drop it onto the oscillator's Octave or Semi selector. As you don't get an orange dot to adjust the modulation depth directly, go into the modulation matrix and adjust it there.
- With lots of positive modulation, the cutoff can be too high even if the knob is turned down to minimum (30.00). All is not lost, however – you can take it much further down in the modulation matrix. With 'Constant' as source and Cutoff as target, set a negative amount. For an example see matrix slot 02 in *09 Loops - untuned / HS Analogue Noise Hits*.
- Does the delay sound too wobbly or not wobbly enough? Go into the matrix, select the panel preset *09 UnWow the Delay* and adjust the lower of the two modulation amount knobs. The upper knob lets you adjust the overall delay time ('Time Scale') – another hidden parameter itching to be used for more experimental sounds.
- For waveform variations, you can use Constant to adjust the pulse width of a pulse wave. Or even set a Phase offset between the main oscillator and its sub-oscillator. Try this:
  1. Load *init* by right-clicking on the data display.
  2. Set the SUB1 waveform to Sawtooth and Tune to 0.00, then switch SUB1 on for filter 1. The result is a pair of saws with a 90° phase offset – have a look at the waveform in the Scope.
  3. In the matrix, select the **10 Phase Control** panel preset and adjust the upper modulation amount while listening carefully. At around -25 or +75 you should hear a perfect octave, with various timbres between those values.
  4. Moving the amount knob sounds like PWM (see the next page) – so try modulating oscillator Phase with a slow LFO instead of or in addition to the Constant.
- Constant can also unison-detune oscillators well beyond the maximum range of the Detune knob. Applying multiple times adds more detuning. See **07 Chords / HS Klustah 1 - pure**, which uses 14 slots just for the detuning. Note: There's a mod matrix panel preset for detuning oscillator 1 called **06 More Detune**.
- As Constant is reset per voice you can use it with slew (SL) as a one-shot Attack envelope. For instance to create a bouncy attack by modulating SUB Tune – try that!

## Pulse Width Modulation

---

- A chorus-like effect at the oscillator level, PWM is ideal for ‘string ensemble’ sounds as well as for simple but rich-sounding leads and basses. The first method is regular PWM using a Pulse oscillator and an LFO:
  1. Load *init* by right-clicking on the data display.
  2. Set OSC1 Wave to Pulse (the PWM-capable version of Square).
  3. In the first Matrix slot (01), select LFO1 as the Source.
  4. Click and drag the crosshair from one of the Target selectors in matrix slot 01 and drop it onto oscillator 1’s Wave selector: the Target selector should now read ‘Osc1:PulseWidth’.
  5. Turn the modulation amount up to about 50, play a low note and listen. Adjust LFO1 Rate.
  6. Does the PWM effect “seesaw”, i.e. is it not round enough? Change the LFO wave to Sine and listen again. Try various LFO Rates.
  7. Start again, but instead of step 3 load the *04 PWM via LFO1* matrix panel preset.
- Here’s an alternative method that uses a pair of saw waves with one of them inverted:
  1. Load *init* by right-clicking on the data display and set SUB1 Wave to *like Osc*.
  2. Tune the SUB’s Tune knob to about 0.20, but leave its Volume at minimum.
  3. In the Matrix, select Constant as the source then drag from a Target up to the SUB1 Volume knob. Set the amount to -100 (negative 100) for an inverted sawtooth at maximum volume.

## Wavetable Tricks

---

- Experiment with the 2D capabilities, not only with the wavetable preset *3 Overtones.uhm*. For instance *FM Fold Rhythm.uhm*, which normally includes several gaps of silence, changes its overall character if you set *Tables* to e.g. 4.
- Would you like an instant sitar-ish synth or a typical FM e-piano? Then try this: Load *init* (right-click on the data display), select *Wavetable* as OSC1 Wave, load *DX Piano.uhm*, select Auto Mode *one shot*. Play that sound, then activate Reverse and play the e-piano.
- Always try adjusting the all-important parameter *Position* while auditioning wavetables. You don’t even have to open wavetable panels in the hexagon, as the *Position* is also available in each oscillator panel – simply click on the the waveform graphic and drag it vertically.
- Some factory wavetables contain sudden transitions from one frame to the next, either tonally or in level. You can make good use of these by setting *Position* close to such a transition and modulating it within a very narrow range: Great for odd rhythms or special-sounding attacks... sometimes the smaller modulation amounts deliver the more dramatic results.

## Filter Tricks

---

- Only one lowpass filter is necessary for a classic analogue sound, so you can use Filter1 to boost the bass of the raw oscillator signal before it reaches Filter2: Set Filter1 type to *Peaking*, add resonance (about 30 should be enough), leave KeyTrack at minimum and adjust the Cutoff until you hear the right kind of bass bump on low notes. Finally, turn Filter1 volume down to zero and select FILT1 as the **only** input for Filter2.
- With parallel filter routing you can emulate the “leakage” effect typical of certain multimode filter designs: Add a tiny amount (1.00 should be plenty) of the unfiltered oscillator signal.



- The Comb filter is capable of polyphonic chorus / flange effects: Set the Ratio to 75 and modulate it with a Triangle LFO, Depth = 25. Use that same LFO to modulate filter Spread a little, then adjust Cutoff and Resonance to taste.

## Envelope Tricks

---

- Clicks: At minimum, the attack, decay and release phases are very fast, so notes played with Hive can click as much as (or even a little more than) any real analogue synthesizer. Mild clicking can give notes more “thwack”, but if you want to remove it completely, set the amp envelope Attack to at least 1 and the Release to at least 8.

If you set the oscillator Phase mode to ‘Reset’, all clicks will sound exactly the same unless oscillator phase is modulated. You have complete control!

- For a snappy decay, negatively modulate Decay from the same envelope. For a short “pre-attack”, set the Attack to about 25 and modulate it -100% from the same envelope. Positive modulation has the opposite effect i.e. it gives you a convex curve.
- Experiment more often with the MOD envelope in ‘One Shot’ trigger mode instead of the usual ‘Gate’. Higher ‘Sustain’ levels can lead to surprising results!
- For access to some extra LFO shapes in sync with the regular LFOs, set the trigger modes of any otherwise unused envelopes to *LFO 1* or *LFO 2*.
- In addition to positive “Mod Env” depth modulation, it is fairly common to modulate cutoff directly from velocity. Alternatively, modulate the Sustain level of that same envelope.
- Try modulating the vibrato amount with an envelope. You can easily create an initial ‘growl’ or wobble that quickly fades out.
- Try using two envelopes instead of one (warning: this can get a bit complicated). For a 2-stage decay, modulate the Sustain of one envelope from another with a much slower Attack or Decay. For a typical ‘cinematic swell’, modulate the filter Input gain or Volume by the other (also with a much slower Attack or Decay).
- Experiment! For instance, try modulating each stage of an envelope from the 4 lanes of the shape sequencer, or get a pair of envelopes to modulate each other.

## LFO Tricks

---

- Modulate a single target from both LFOs, with various Sync ratios and phases. For instance two square waves modulating OSC1 pitch, or create staircase patterns using two sawtooth LFOs with opposite polarities.
- LFO waveforms can be skewed via recursive modulation of the Phase or Rate. For instance, try setting the source to LFO1 and the target to LFO1 Phase. You can change the pulse width of a square wave by letting it modulate its own Rate. View these signals in the scope!

## Shape Sequencer Tricks

---

- Activating “prime numbers” of cells in each lane will ensure that sequences don’t repeat for a long time, even if all the shape modulators have the same *TimeBase*: For instance, try looping 3, 4, 5 and 7 cells together. This will only repeat after 420 beats, and if for instance you double the *TimeBase* of that ‘7’ shape modulator, only after 840 beats! A little math can go a long way.

- If you are using the shape sequencer together with Hive's arpeggiator / sequencer, try setting the clock slower than the shape modulators (or the shape modulators faster than the clock) so that more than one segment can be triggered per note.
- Try making a long envelope using all 8 segments, then choose the most suitable segments for other tasks (using the other 3 lanes) afterwards.
- The Time Base option 'Halt' can be used to reshape any unipolar modulator. An experiment:
  1. Load *init* by right-clicking on the data display.
  2. Set SHAPE A Time Base to 1/1 and drag its crosshair onto OSC1 Octave or Semi. Turn up the modulation amount in the matrix and play a note to check out what happens.
  3. Switch SHAPE A Time Base to 'Halt'. Drag and drop the Mod Wheel mod source selector (in the the lower bar) onto matrix slot 02 source field. Set the upper target of that matrix slot to Shape Sequencer **Position A**. Turn up the amount and text what the mod wheel does to pitch: it scans through the two segments of SHAPE A. Edit those shapes and change the order to *One by One*. Instead of the mod wheel you could try a function generator or unipolar LFO... or even another SHAPE modulator!

## Function Generator Tricks

- With LFO-triggered *One Shot* envelopes, the gate outputs can function as clock dividers. Here's an example (Input = square LFO, the slower gates are created by adjusting A and D):

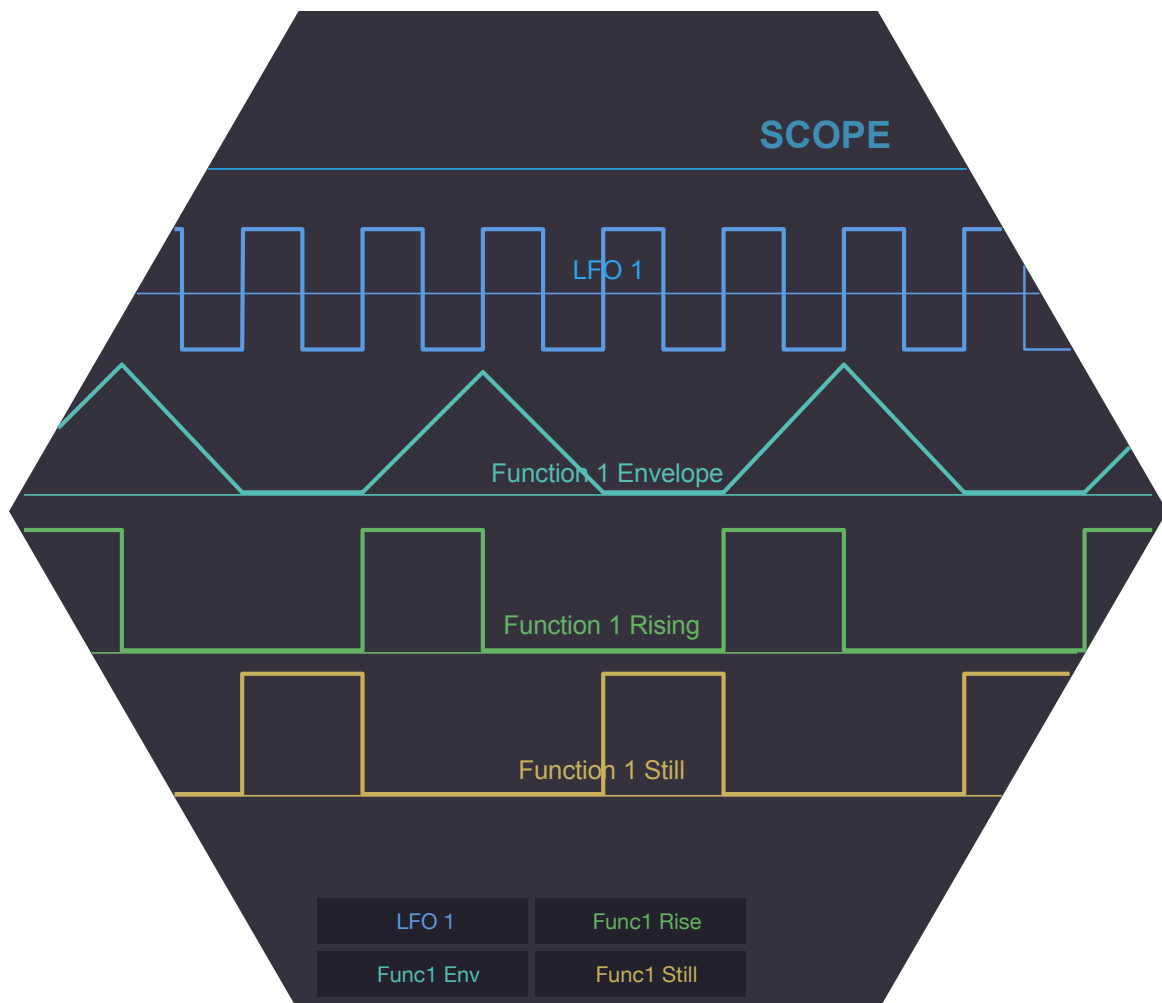

- Here's a **random-rhythm** trick which appears to be well-known in the modular synth world: Set FG1 Input to *LFO1* and its Mode to *One Shot*. Leave FG1 Attack at 0 and adjust Decay so that FG1 only triggers at about half the speed of the LFO (view the LFO1 and the FG1 Env signals in the Scope). Next, use FG1 Env to modulate e.g. filter Cutoff. Finally, modulate FG1 Decay with an unsynchronized LFO2 (set TimeBase to 1s and adjust the Rate).

If LFO1 and LFO2 Restart are both set to *gate*, the resulting pattern will be the same for each note you play. Of course you can modulate the LFO rates to make the effect completely chaotic. Also try setting LFO1 Restart to either *sync* or *single* for a chord strumming effect.

- Func1 Still* or *Func2 Fall* can be used to delay something e.g. when an oscillator will become audible (modulate its Volume). Use Attack/Decay to adjust the time before the gate opens.
- To avoid wrist strain while adding vibrato or opening the filter via aftertouch, try routing Pressure through an FG set to one of the *Follow* modes. Turn the FG Decay to maximum and the Attack to taste. A short "stab" of pressure is enough to keep the vibrato (or cutoff) up for a while after you release the key.
- The various LFO waveforms cross zero (in the positive direction) at different phases, which can cause the FG to trigger too late i.e. after you have played the note. To ensure that the FG trigger and MIDI Note On coincide, adjust the LFO Phase as follows.

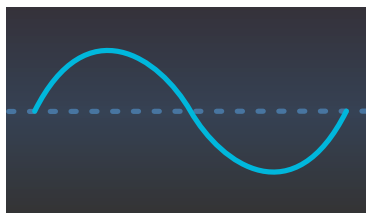

Bipolar Sine, Phase = 0

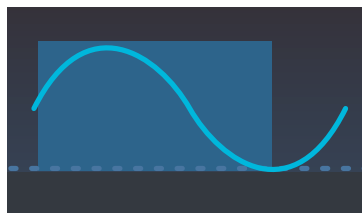

Unipolar Sine, Phase = 75

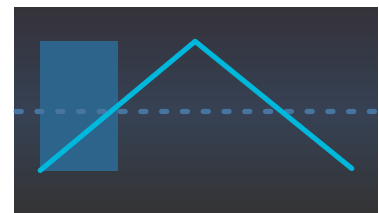

Bipolar Triangle, Phase = 25

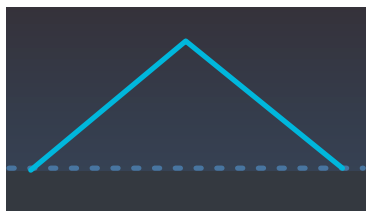

Unipolar Triangle, Phase = 0

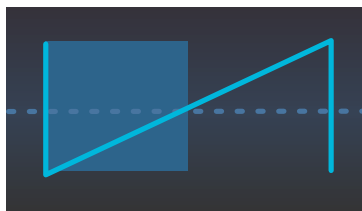

Bipolar Saw Up, Phase = 50

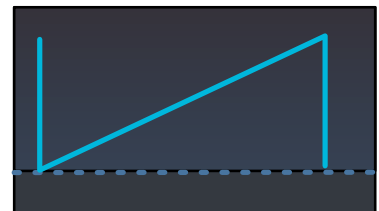

Unipolar Saw Up, Phase = 0

## Mod Matrix Tricks

- You can quantize an LFO so that its speed can only be halved or doubled by any rate modulation. Or in this example, 2, 4 or 8 times the speed: Starting with *init*, select the LFO1 waveform *saw down*, set its Restart mode to *sync* and Time Base to  $1/4$ . Drag Velocity from the lower bar and drop it onto the Rate knob. In matrix unit 01, choose the *expanded* curve (this ensures that fairly low velocities don't already double the LFO rate) and *integer* quantization. Turn the modulation depth knob up to 60.00. In Filter 1 reduce the Cutoff and turn LFO1 cutoff modulation up. Now try playing notes with very different velocities.
- You can double the rate of a triangle wave LFO by setting the rectification to full wave +.

- To transpose a random selection of your played notes up an octave, try this experiment: Starting from **init**, set a source in the mod matrix to Random, the target to Oscillator 1 Tune (drag & drop to its Octave or Semitone selector) and the depth to about 30 for now. Next, right-click on the target selector, choose the Quantize mode *steps of 12* and the Rectify mode *half wave +*. Play the same note repeatedly to test how often the higher octave appears. Turn the depth up to 75 for more, or even higher for the occasional note 2 octaves up.
- Try setting the same target parameter in both slots, but with a different set of slot modifiers. The matrix preset '12 Funny Release' is a good example: The amounts are equal but in the opposite directions: They would normally cancel each other out, but the Slew Limiter of the upper slot is set to *slow* so that the pitch bounces upwards on release.
- Here's a related trick, a different-sounding glide which will only work when the Voice Mode is set to legato: Modulate oscillator Tune by KeyFollow twice, with the modulation depths set to -100 and +100, then choose slow SL (slew) for the slot with the positive modulation.
- For stronger pitch modulation with quite a different curve, try *overtone series* quantization with *smooth* slew limiting (SL). If you are using an LFO as mod source, make it unipolar.
- The depth knobs in the matrix are also valid modulation targets, which practically gives you an extra "Via" modifier per slot. As this feature has only been implemented since version 1.2, few of the factory presets use it. This is mostly uncharted territory just waiting to be explored!

Here's an example for all you gold-caped keyboard wizards out there. This trick applies vibrato from any mixture of modulation wheel or aftertouch, perfectly balanced:

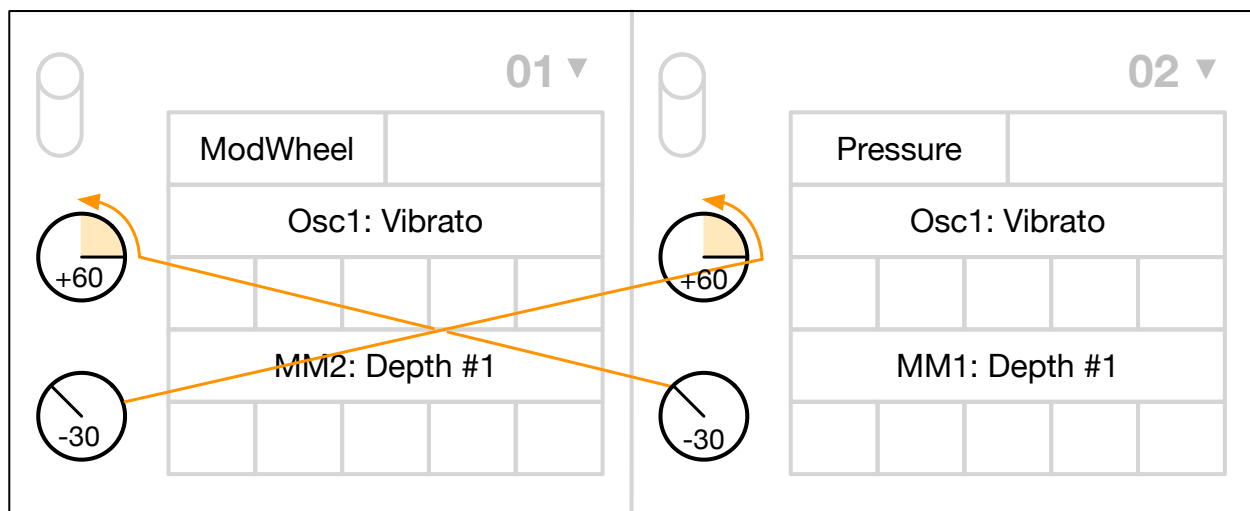

How it works: Applying maximum pressure reduces the amount of modulation from the wheel to zero and vice versa so that the sum of both modulation depths for the vibrato is always 60%. You only need -30 modulation to remove +60 here... just one of Hive's many quirks!

- The *ModNoise* source can be used to 'roughen' any target, but smoothed by two slew limiters it can also be used for emulating the typical instability of old analogue oscillators: Starting from **init**, set the main source of matrix slot 01 to *ModNoise*. Drag from the upper target field onto the lower knob **in that same matrix slot**, then from the lower target field onto OSC1 *Semitone*. Turn the upper Depth knob up to about 20 (the lower Depth is being modulated, so leave it at 0.00). Finally, set both slew limiters (SL) to *slow*. Try mixing with a perfectly 'stable' oscillator...
- The *Random* modulation source normally only retriggers when a new note is played. However, it will **also retrigger via SH** (Sample & Hold) in the matrix. For instance, you could use the Shape Sequencer to trigger random pitches, simulating an LFO in *rand hold* mode: Set the main source to *Random*, and SH to one of the *ShapeSeq* sources.

## XY Pad Tricks

---

- Unipolar parameters set to zero will only respond to movement in the “positive” areas of the XY pad. Try this: Turn that parameter up and move the assigned XY control equally far into the negative before saving your preset. That way you can use the full width/height of the pad.
- Although the automatic XY assignment is usually good enough, you can often achieve a better “feel” if you tweak the ranges to perfection.
- Although the 24 matrix Depth knobs are not normally available in the XY target menu, if you move one it will appear in ‘Assign Recent’ at the top of that menu.

## Arpeggiator & Sequencer Tricks

---

- Here’s a very quick method of turning a simple 3-note chord into a ‘rolling’ sequence with consistent velocities: Activate the arpeggiator, press [REC], play chords and release whenever you are happy with what you are hearing.  
Switch to Run mode [▶] and deactivate the arpeggiator. Play a note and listen to your creation. Depending on the number of notes in the chord, it can skip at the end: Click on [Shift] left or right until the sequence starts on the “correct” note.
- Vary sequence length: MIDI-learn the ‘Steps’ selector, then with a 16-step sequence running, quickly change the number of steps from 16 down to 2 or 3. Watch how the sequence runs backwards (!) until it can comply with the new setting. Keep performing...
- As well as using Seq Mod to offset an oscillator’s pitch away from the others, you can even add a third melody in parallel using the velocity data. This may be tricky to set up, but it works!

## Delay & Reverb Tricks

---

- For early reflection effects set the Left and Right delays to 1/32 and 1/16T and turn diffusion up to maximum. Starting from zero, slowly adjust the feedback until it sounds like a cheap reverb effect. Then adjust the LP and HP values to thin out the reverb tail until you reach the desired ambient effect. If the current song tempo is very slow, you might have to speed up the delay by negatively modulating its Time Scale with the source ‘Constant’...
- Adjusting the delay’s Time Scale can also add swing to rhythmic presets – see e.g. matrix slot 03 in the ‘HS Rotation Shuffle’ presets, and compare the sound with and without FX.
- Try setting a very small reverb size e.g. 4.0 with very little damping, a long decay and high mix value – you should start to hear comb filter type resonant effects. With practice you can achieve typical wind-instrument formants or small resonators (banjo, acoustic guitar, metal canister etc.)!
- In addition to the above, pre-delay will give you a coloured slap-back delay effect.
- Extreme values are a useful source of inspiration. For ‘infinite space’, set the Size and Decay both to maximum, Damp and Tone to the default values (double-click).
- For strange, moving spaces try independently panning the delay and the reverb effects by modulating their hidden ‘Pan’ parameters. Use Constant as source first, then try ‘Single’ mode LFOs or Shape Modulators.