

Packaging Contents

Tent

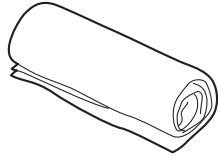

Tent Bag

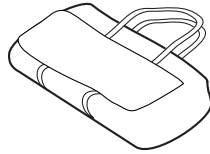

Rain Fly

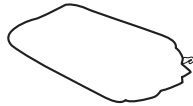

Fiberglass Poles

Color/Qty	Location
Blue (2)	(Criss-Cross, Corner-to-Corner)
Green (1)	(Front-to-Back)
Yellow (1)	(Front Door)

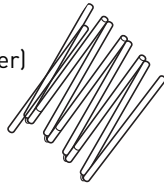

Pole bag

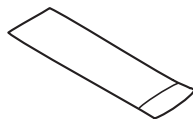

Awning/Canopy Version Only

Awning

Color/Qty
Red (2)
Steel (2)

Location
Inside of Awning
Awning Support Poles

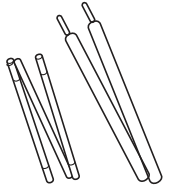

Guy Ropes



Stakes

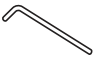

Need installation help? Missing parts?

Text us to 360-215-3930 or email us to questions@offroadinggear.com

WARNING

- Keep all flame and heat sources away from the tent fabric. The tent is made with flame-resistant fabric which meets CPAI-84 specifications. This does not make it fireproof. The fabric will burn if left in contact with any flame source. The application of any foreign substance to the tent fabric may render the flame-resistant properties ineffective.
- To prevent carbon monoxide from entering the vehicle and tent area, do not run the engine, do not cook inside the tent, and do not use a gas heater in the tent. Carbon monoxide is dangerous to your health.
- Engine must be off and exhaust must be fully cooled before tent installation and use.

CAUTION

• NEVER drive the vehicle while the tent is installed.

- NEVER run the engine while the tent is installed.
- Do not refuel lanterns, stoves or heaters inside tent.
- Do not cook inside the tent.
- Do not store flammable liquids inside the tent.
- NEVER allow the vehicle engine to run while you are inside the tent
- Do not install the tent when the outside temperature is less than 0°C/32°F as it may cause damage.
- Do not install the tent when your vehicle is wet as it may cause damage.

Choosing a Campsite

- Select a level site clear of rocks, branches, and other hard or sharp objects, to set up your tent.
- Position the vehicle in the desired campsite. Turn off the engine. Apply the parking brake.

Setting Up the Tent

For the easiest assembly, consider setting up the tent off of the truck first (except for steps 2, 3, & 4). Then, with the help of another person, lift the tent onto the bed of the truck and follow steps 2, 3, and 4 to secure the tent to the truck.

1. Lower the tailgate.

2. Remove the tent from the bag. Lay it flat on the truck (or alternatively, lay it on the ground if setting it up off the truck first).

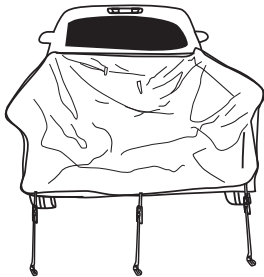

3. Locate the side straps and clips. Attach each to the underside of the truck body as shown. Do not tighten until the end.

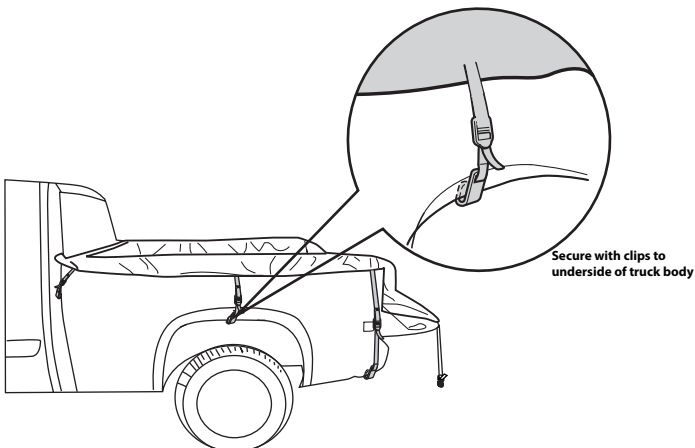

4. Locate the tailgate straps and buckles. Slide the female clip under the tailgate and buckle tight with the male end. Note, you may have to lift your tailgate slightly to get the female buckle/strap under the tailgate.

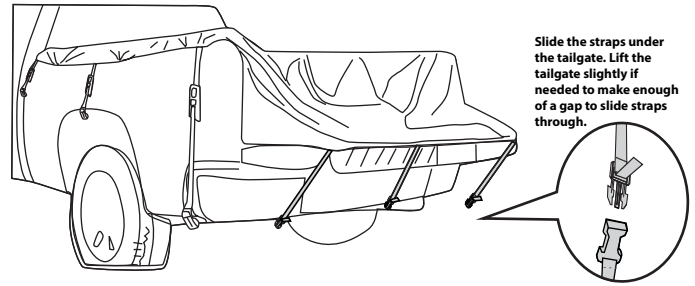

5. Assemble each of the poles.

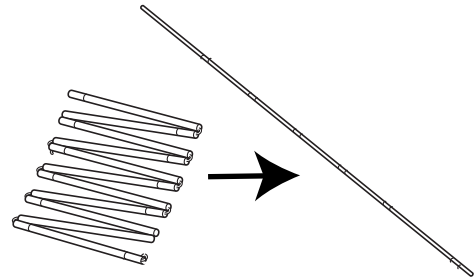

Color/Qty	Location
Blue (2)	(Criss-Cross, Corner to Corner)
Green (1)	(Front to Back)
Yellow (1)	(Front Door)

6. Slide the poles into the appropriate sleeve in the order below. Do not place poles in the pockets until the end.

- Insert the BLUE CRISS-CROSS POLES corner to corner. These will be the roof/dome of the tent.
- Insert the GREEN FRONT-TO-BACK POLE from the front of the tent (tailgate) to the front (cab area). This will also be a supporting pole for the roof of the tent
- Slide the YELLOW POLE into the pocket near the front (tailgate) of the tent at the door. This will be the supporting pole for the door.

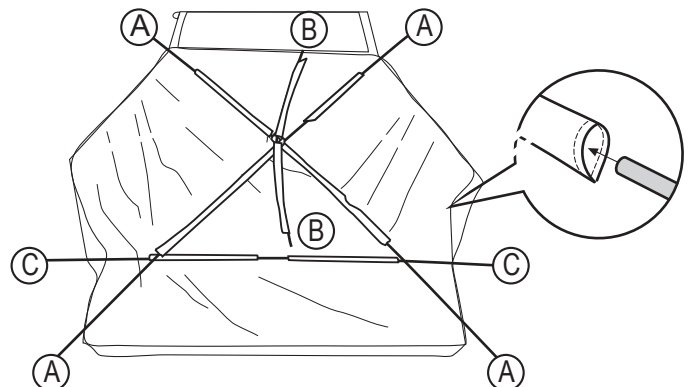

7. Insert each of the poles into the pockets as shown below.

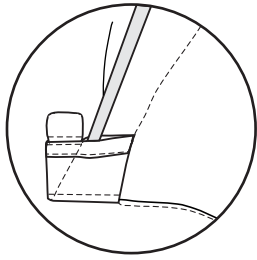

8. After all the poles are in the pockets, attach the poles' clips to each pole as shown below.

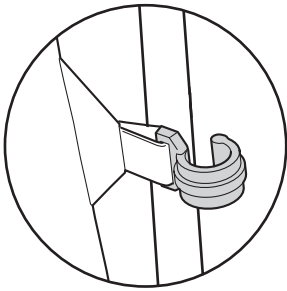

Rainfly Setup

1. Locate the front of the rainfly. Place the rainfly over the tent from front to back. Due to the height, you may require assistance.

2. Secure the rainfly to the tent using the clips

Awning Setup (If applicable)

Note: Not all tent models come with the awning.

Note: If you do not wish to use the awning, roll it up and secure it with the attachments.

1. Insert the RED inside awning poles into the underside of the awning.

2. Insert one end of the STEEL support poles into the top of the awning grommet top. Insert the other into the grommet near the door. This will support the awning as shown below.

3. Secure with the strap tightly.

OPTIONAL GROUND MOUNTING

1. Insert one end of the pole into the awning grommet. Stake the other end into the ground.

2. Secure the guy rope to the top of the awning pole and tie tight to the ground, using the pegs.

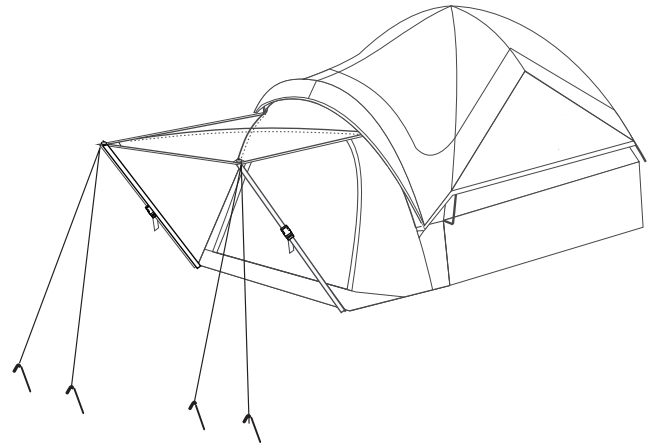

WARNING: KEEP ALL FLAME AND HEAT SOURCES AWAY FROM THIS TENT FABRIC /

MISE EN GARDE : TENIR LE TISSU DE CETTE TENTE LOIN DE TOUTE FLAMME ET DE TOUTE SOURCE DE CHALEUR

This tent is made of flame-resistant fabric. It is not fireproof. The fabric will burn if left in continuous contact with a flame source. / Cette tente est fabriquée d'un tissu résistant au feu, mais qui n'est pas ininflammable. Ce tissu brûlera s'il est laissé en contact continu avec une source d'inflammation.

As per Section 4(c) of the Tents Regulations, the label must also display the information set out in Schedule I or words that convey the same meaning.

The following precautions should be taken when camping:

Do not use candles, matches or open flames of any kind in or near a tent.

Do not cook inside a tent.

Build campfires downwind and several metres away from a tent and be sure to fully extinguish campfires before leaving a campsite or before retiring for the night.

Exercise extreme caution when using fuel-powered lanterns or heaters inside a tent and use battery-operated lanterns whenever possible.

Do not refuel lamps, heaters or stoves inside a tent.

Extinguish or turn off all lanterns before going to sleep.

Do not smoke in a tent.

Do not store flammable liquids inside a tent.

Les précautions suivantes doivent être prises en camping :

Ne jamais utiliser de bougies, d'allumettes, ni aucune autre flamme nue à l'intérieur ou à proximité de la tente.

Ne pas faire de cuisson à l'intérieur de la tente.

Faire les feux de camp à plusieurs mètres de la tente, du côté autre que celui d'où souffle le vent; s'assurer de toujours bien éteindre les feux de camp avant de quitter le terrain ou de se coucher.

Être extrêmement prudent lorsque des lanternes ou des appareils de chauffage à combustible sont utilisés à l'intérieur de la tente et se servir autant que possible de lanternes à piles.

Ne jamais remplir le réservoir des lampes, des appareils de chauffage ou des poêles à l'intérieur de la tente.

Éteindre toutes les lanternes avant de se coucher.

Ne pas fumer à l'intérieur de la tente.

Ne jamais ranger des liquides inflammables à l'intérieur de la tente.