

CODE NUMBER

3912746

DESCRIPTION

0.5 gpf, Polished Chrome Finish, Fixture Connection Top Spud, Single Flush, Battery, Royal® Exposed Sensor Urinal Flushometer.

DETAILS

- Flush Volume: 0.5 gpf (1.9 Lpf)
- Finish: Polished Chrome (CP)
- Power Type: Battery ()
- Valve: Diaphragm
- Valve Body Material: Semi-red Brass
- Fixture Type: Urinal
- Fixture Connection: Top Spud
- Rough-In Dimension: 11 ½" (292mm)
- Spud Coupling: ¾" (19mm)
- Supply Pipe: ¾" (19mm)

FEATURES

- True Mechanical Override Flush Button
- Four (4) size C alkaline batteries included
- "Low Battery" Flashing LED
- "User in View" Flashing LED
- 72-Hour Sentinel Flush
- ¾" I.P.S. screwdriver Bak-Chek® angle stop with free spinning, vandal resistant stop cap
- Sweat Solder Adapter w/Cover Tube and Cast Wall Flange with Set Screw
- No External Volume Adjustment to Ensure Water Conservation
- Handle Packing, Main Seat, Stop Seat and Vacuum Breaker Molded from PERMEX® Rubber Compound for Chloramine resistance
- Infrared Sensor with Multiple-focused, Lobular Sensing Fields for high and low target detection



COMPLIANCES & CERTIFICATIONS

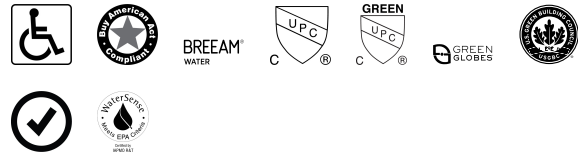

(ADA Compliant, BAA Compliant, BREEAM Water Credit, cUPC Certified, cUPC Green Certified, Green Globes Water Credit, LEED V4 Water Efficiency Credit, Satisfies LEED Credits, WaterSense Listed)

RECOMMENDED SPECIFICATION

Valve Body, Cover, Tailpiece and Control Stop shall be in conformance with ASTM Alloy Classification for Semi- Red Brass. Valve shall be in compliance with the applicable sections of ASSE 1037 and ANSI/ASME 112.19.2.

VALVE OPERATING PRESSURE (FLOWING)

15–80 PSI (103–552 kPa). Specific fixtures may require greater minimum flowing pressure - consult manufacturer requirements.

DOWNLOADS

- [EBV-500/550-A Installation Instructions](#)
- [Control Stop Repair and Maintenance Guide](#)
- [Flush Connections Flanges Repair and Maintenance Guide](#)
- [Tail Piece Repair and Maintenance Guide](#)
- [Additional Downloads](#)

NOTES

All information contained within this document subject to change without notice.

Looking for other variations of the ROYAL 186 SFSM product? [View the general spec sheet with all options.](#)

[Find a compatible urinal](#) for this flushometer.

[Find a compatible water closet](#) for this flushometer.

WaterSense compliant when used with a WaterSense compliant fixture



ROUGH-IN

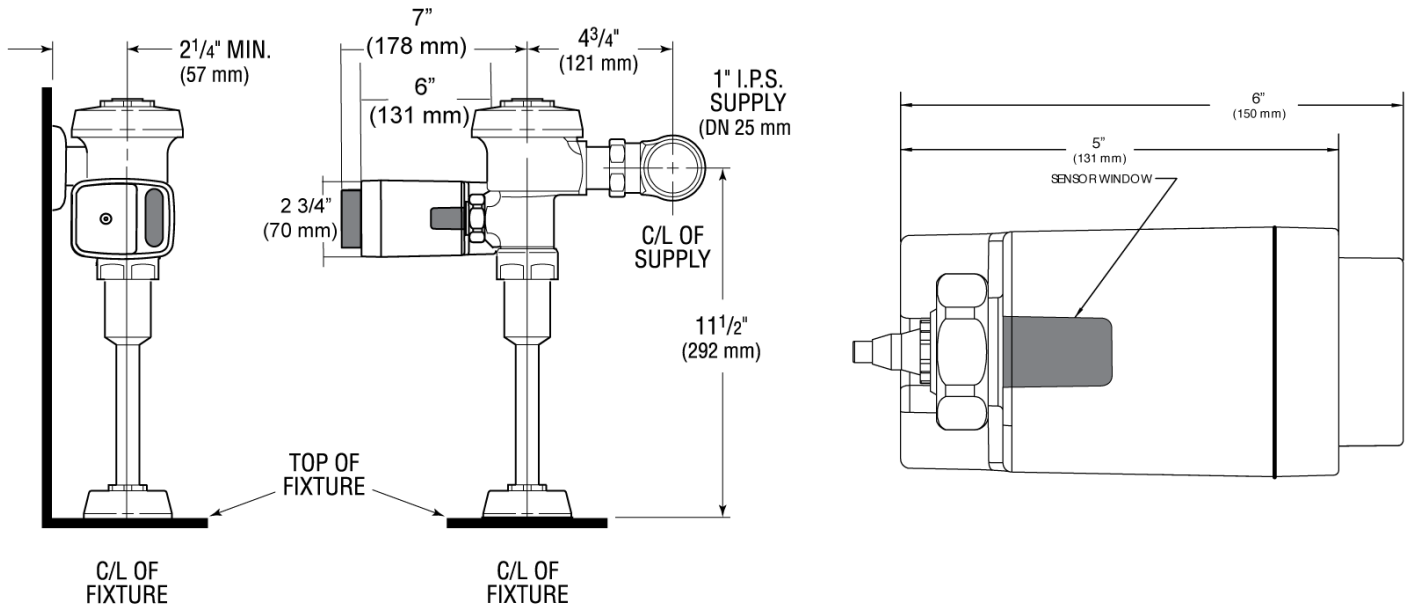

**SLOAN
REPAIR
.COM**

TOLL FREE: 800-442-6622
www.store.sloanrepair.com