

## Hybrid & Waterfree Urinal Series

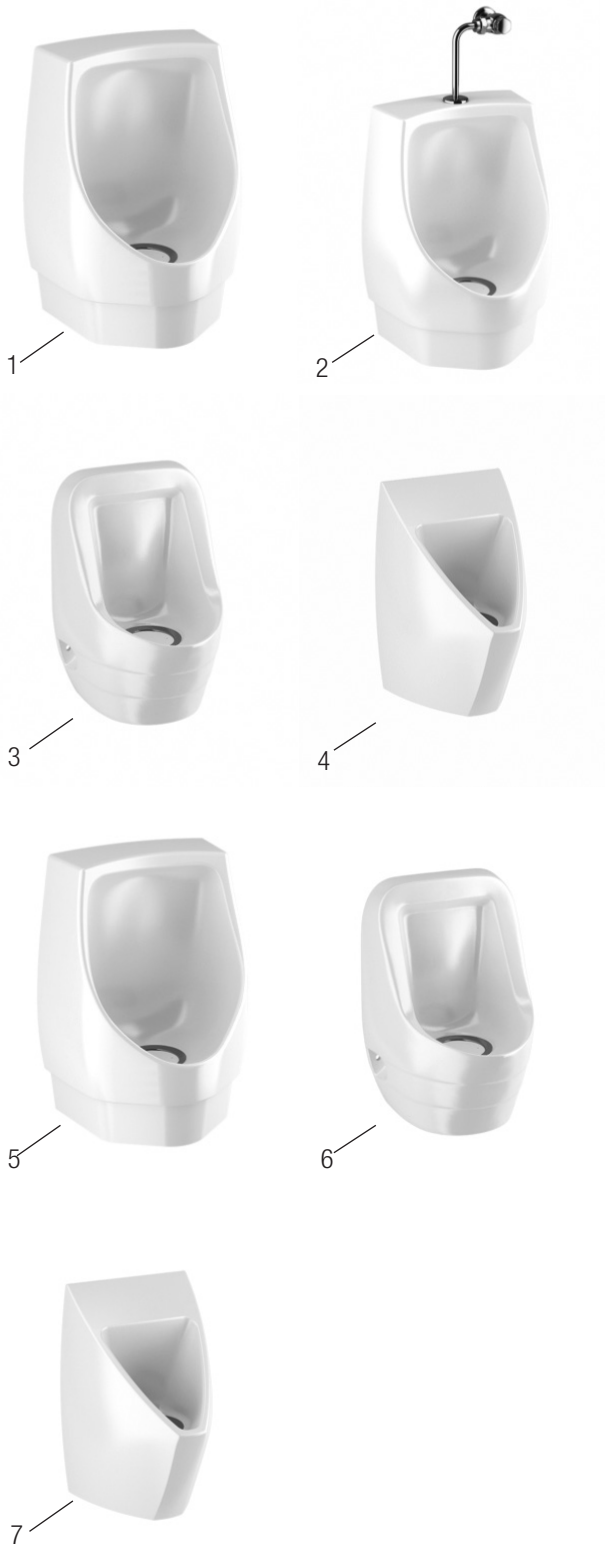

### HYBRID URINAL

#### HYB-1000

1. **1001020** HYB-1000 Vitreous China Standard Hybrid Urinal  
14" × 19 5/8" × 26 3/4"

#### HYB-1000 RET

2. **1001021** HYB-1000 RET Vitreous China Retrofit Hybrid Urinal  
14 3/8" × 16 5/8" × 26 3/4"

#### HYB-4000

3. **1004020** HYB-4000 Vitreous China Hybrid Urinal  
14" × 15 3/8" × 22 5/8"

#### HYB-7000

4. **1007020** HYB-7000 Vitreous China Hybrid Urinal  
14 5/8" × 12 3/4" × 21 7/8"

### WATERFREE URINALS

#### WES-1000

5. **1001000** WES-1000 Vitreous China Standard Waterfree Urinal  
14 3/8" × 19 5/8" × 26 3/4"

#### WES-4000

6. **1004000** WES-4000 Vitreous China Small Waterfree Urinal  
14" × 15 3/8" × 22 5/8"

#### WES-7000

7. **1007000** WES-7000 Vitreous China Designer Waterfree Urinal  
14 5/8" × 12 3/4" × 21 7/8"

## Hybrid & Waterfree Urinal Series

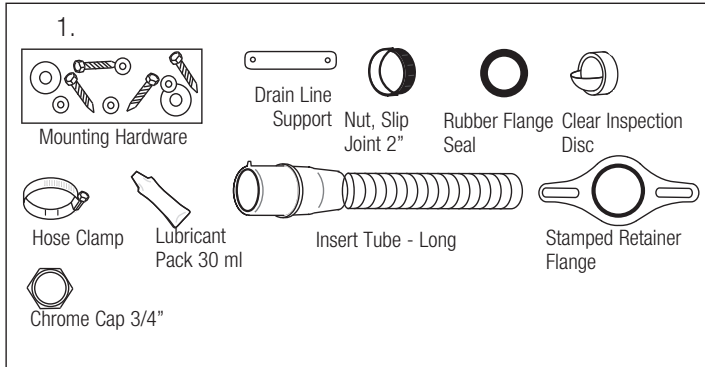
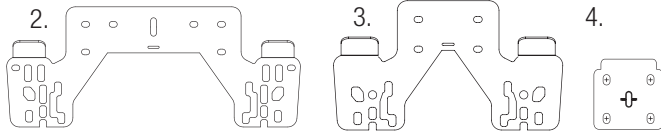

### PARTS LIST—

Item No.	Code No.	Part No.	Description
1.	1001520	WES-20	Uni-Coupler II - Hardware Kit
2.	0372012	WES-34	Hanger Bracket-WES-1000 & HYB-1000
3.	0372022	WES-36	Hanger Bracket-WES-2000 & HYB-7000
4.	0372032	WES-38	Hanger Bracket-WES & HYB-4000, 5000 & WES-7000
5.	1001510	WES-10	Waterfree Housing Assembly
	0214500	HYB-1-A	Hybrid Housing Assembly
6.	10011521	WES-31	Waterfree Wall Plate
7.	1001500	WES-150	Universal Waterfree Urinal Cartridge
8.	0214502	HYB-3-A	Hybrid Air Gap Assembly
9.	0214501	HYB-2-A	Hybrid Base Plate Assembly
10.	0335001	EHF-2	Hybrid Solenoid
11.	0214504	HYB-5	Hybrid 6V Lithium Battery
12.	0335007	EHF-9	Hybrid Filter
13.	0214503	HYB-4-A	Hybrid Service Kit ( Mfg screw, air gap, o-ring & clip)

Not Shown: 1001504 SJS-20 Waterfree Cleaner (cleaner concentrate refill)  
 Not Shown: 1001503 SJS-19 Waterfree Starter Kit (32 oz. spray bottle & cleaner concentrate refill)  
 Not Shown: 0372001PK WES-1 3/4" water supply inlet cap  
 Not Shown: 0372002PK WES-2 1" water supply inlet cap

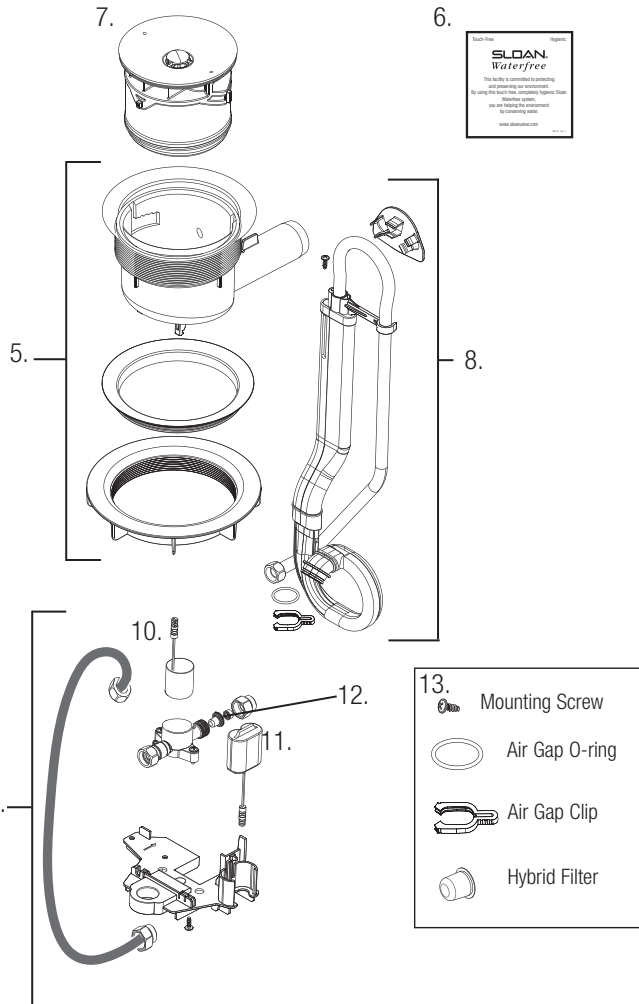

### PRODUCT DESCRIPTION

Sloan Waterfree Urinals use no water which reduces germs and odor. This is because odor-causing germs and bacteria require water to live and to multiply.

Urine contains biosolids.

- For a water flushing urinal a very hard material called calcite forms in the p-trap and drain walls when urine mixes with water. Calcite causes clogs and requires a mechanical auger to remove.
- For a waterfree urinal a soft buttery substance known as struvite forms in urine in the absence of water. Struvite can form in drain lines over time, however, it is water soluble and only requires water to clean.

Sloan utilizes a patented cartridge assembly as the core of its waterfree urinal operation.

### HOW IT WORKS

1. The cartridge begins full of liquid with a layer of proprietary biodegradable sealant that floats on the surface.
2. Waste enters the cartridge and passes through this sealant which isolates foul odors from the restroom.
3. Flowing waste is slowed by internal baffles that help retain sealant and allows the uric sediment to settle.
4. Waste flows past an internal trap and exits the cartridge leaving some of the uric sediment behind.
5. The urine accelerates as it is funneled down to a flexible spout where it is redirected out of the housing and into the drain pipe.

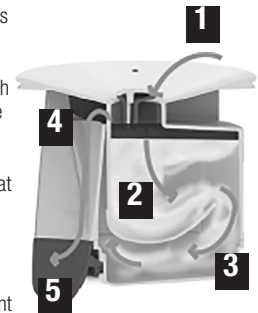

Waterfree urinals require regular maintenance to prevent struvite formation from causing drain line blockages-cartridge change & line flushing.

Sloan hybrid urinals offer an automatic drain-rinsing feature that utilizes a controller and solenoid valve to inject water through housing and the lateral drain line.

## Hybrid & Waterfree Urinal Series

### OPERATION (Hybrid Urinals Only)

#### 1 AUTOMATIC OPERATION

After waterfree cartridge has been installed and the battery has been connected, the Hybrid Urinal will begin automatically activating about two times per week (every 72 hours from the time the battery is plugged in).

#### 2. MANUAL OPERATION

The Hybrid Urinal should always be manually activated during regular cartridge changes to confirm operation. To do this, wave your hand underneath the urinal within 2 inches to the sensor (see diagram below). You will hear a "CLICK" of the solenoid followed by approximately 10 seconds of rushing water, a three second pause and another 10 seconds of rushing water flowing through the housing and drain line.

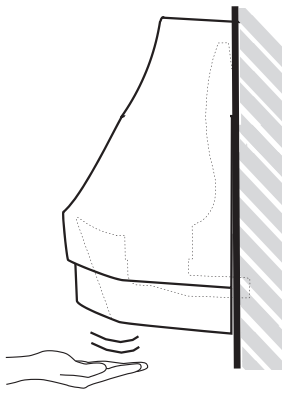

NOTE: After 2 manual activations in a row, there will be a 120 second delay before a third activation can be initiated.

### CARTRIDGE REPLACEMENT

The urinal exterior should be cleaned nightly according to the instructions below.

#### URINAL BOWL CLEANING INSTRUCTIONS

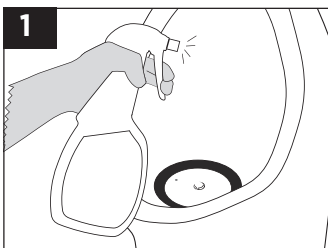

Spray (mist) cleaner on entire bowl.

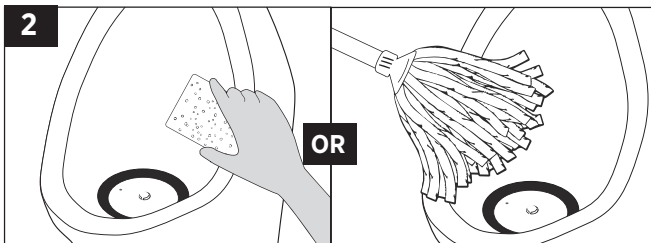

Clean outside and inside of bowl with rag or sponge. Clean outside and inside of bowl with mop.

## Hybrid & Waterfree Urinal Series

### CARTRIDGE REPLACEMENT

The cartridge should be changed according to the instructions below:

#### CHANGING THE CARTRIDGE



1 Insert Key into cartridge, turn key to left to unlock.

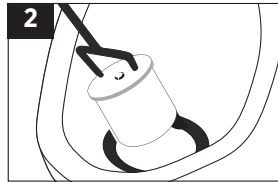

2 Lift and tilt cartridge to drain all free liquids (water, sealant and urine).

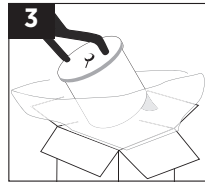

3 Place cartridge into bag, tie bag to seal and dispose.

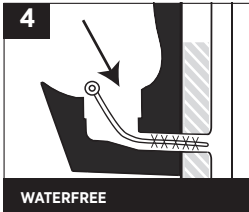

4 Scrub the housing and deep inside of the tail pipe with a long 1.5" diameter nylon brush.

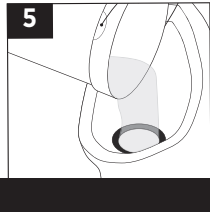

5 Flush housing with 5 gallons (20 Liters) of hot soapy water.

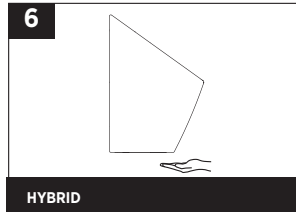

6 Hybrid Urinal Technology should be manually activated each time the cartridge is changed to confirm operation and determine if battery level is sufficient.

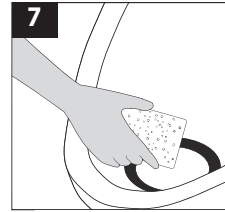

7 Wipe clean inner stainless steel rim.



8 Insert new cartridge into housing and turn key to right to lock and click into place.

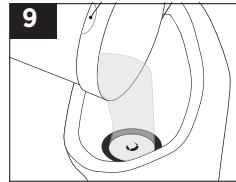

9 Slowly fill cartridge with 1 quart (1 Liter) or more of clean water until there are no more air bubbles.

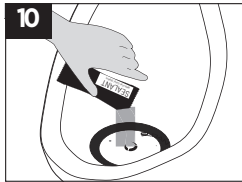

10 Add blue sealant (allow time to drain into cartridge).

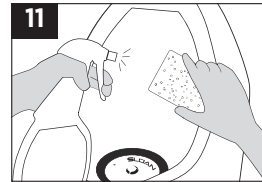

11 Spray (mist) cleaner and wipe clean.

### BATTERY REPLACEMENT (Hybrid Urinals Only)

Your battery is a long-lasting lithium and should provide approximately 8 years of operation.

When the battery is low the solenoid will produce an audible chattering sound at the end of activation. This indicates that the battery should be replaced.

#### REPLACING THE BATTERY

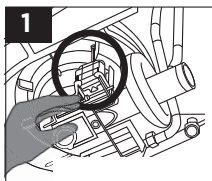

1 Reach underneath the urinal and locate the battery.

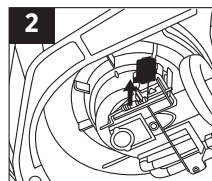

2 Remove the battery from the cradle.

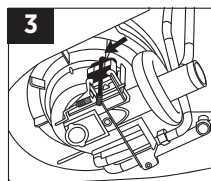

3 Unclip the battery from wire and replace with fresh battery.

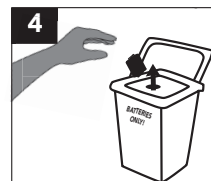

4 Properly dispose of lithium battery according to local codes.



5 After 1 minute the unit will be ready for operation. Swipe hand within 2 inches of sensor and visually inspect that water flows into housing, ensure cartridge is out of housing for inspection.

## Hybrid & Waterfree Urinal Series

### TROUBLESHOOTING

#### 1. URINE IS NOT DRAINING OR DRAINING SLOWLY

- Cartridge is full, replace with new cartridge according to instructions inside box.
- Cartridge is not fully locked into place. Sloan logo should be at the 12:00 position when facing the urinal. Use cartridge tool to rotate clockwise until fully seated.
- Improper drain line slope:
  - Tube-in-tube is not installed correctly. Remove urinal from wall and check that arrow tab on black rubber drain tube is at the 12:00 position. Rotate accordingly.
  - Drain line is not pitched correctly. Use standard mending plate to correct drain line pitch. NOTE: Adjustment and re-installation of the urinal hanger bracket may be required to allow the housing drain tail pipe to properly fit into drain line.
  - Housing and/or drain line is clogged. Scrub housing with nylon brush and flush with soapy water according to cartridge replacement instructions.

#### 2. URINE IS ON THE FLOOR/LEAKING

- The hose clamp on the drain is not tightened adequately. Tighten the hose clamp until leak stops.
- Housing is loose. (Hybrid Urinals only) Remove the screw on bottom of electronic board, unclip the electronic board from the bottom of the housing. Lower the electronic board down and out of the way. Unsnap the housing exit tube and use special tool to tighten housing.
- Housing is cracked, urinal bracket is too low placing load onto housing tail pipe inside drain.
  - Raise hanger bracket as necessary to provide concentric insertion of tail pipe into drain line.
  - Replace broken housing.
  - Reinstall urinal according to installation instructions ([www.sloanvalve.com](http://www.sloanvalve.com)).

#### 3. THERE IS A FOUL ODOR COMING FROM THE URINAL

- Cartridge sealant is not present. Dip a rolled up corner of paper towel into the opening at the top of the cartridge. If the paper towel comes out clean or without blue sealant, change the cartridge.
- Odor not coming from urinal. Check other sources of odor such as air vents, toilets, trash receptacles or floor drains. For an extensive list of alternate restroom odor sources please visit [www.sloanvalve.com](http://www.sloanvalve.com).
- The gear clamp on the drain is not tightened adequately. Tighten clamp.

#### 4. WATER IS ON FLOOR/LEAKING (Hybrid Urinals only)

- Loose supply stop connection. Tighten compression nut on hose.
- Loose 'loop' connection to housing. Check connections and tighten. Lubricate O-Ring at connection.
- Broken air gap assembly. Replace air gap assembly.

#### 5. URINAL DOES NOT DELIVER ANY WATER WHEN SENSOR IS ACTIVATED (Hybrid Urinals only)

INDICATOR: Solenoid valve produces audible "CLICK."

- Water supply stop(s) closed. Ensure water supply stop is open.
- Solenoid strainer clogged. Remove braided hose from solenoid, clean strainer and replace.

INDICATOR: Solenoid valve DOES NOT produce an audible "CLICK."

- Battery low. Replace battery (refer to Battery Replacement section).
- Electronic board assembly is defective. Replace board.

#### 6. URINAL DELIVERS ONLY A SLOW FLOW OR DRIBBLE WHEN SENSOR IS ACTIVATED (Hybrid Urinals only)

- Water supply stop is partially closed. Completely open water supply stop.
- Solenoid strainer is clogged. Remove braided hose from solenoid, clean strainer and replace.

#### 7. URINAL DOES NOT STOP DELIVERING WATER OR CONTINUES TO RUN AFTER ACTIVATION IS COMPLETE (Hybrid Urinals only)

- Urinal is not working properly:
  - Board needs to be reset. Turn off the water at the stop. Unplug battery. Wait 10 seconds and replace battery. Replace battery. After 1 minute unit should cycle properly.
  - If board reset does not work, contact Sloan Technical Support.