

CODE NUMBER

3370005

DESCRIPTION

0.25 gpf, Polished Chrome Finish, Fixture Connection Top Spud, Single Flush, Electrical Override, Solar, SOLIS® Exposed Sensor Urinal Flushometer.

DETAILS

- Flush Volume: 0.25 gpf (0.9 Lpf)
- Finish: Polished Chrome (CP)
- Power Type: Solar (S)
- Battery Life: 6 years
- Valve: Diaphragm
- Valve Body Material: Semi-red Brass
- Fixture Type: Urinal
- Fixture Connection: Top Spud
- Rough-In Dimension: 11 ½" (292mm)
- Spud Coupling: ¾" (19mm)
- Supply Pipe: ¾" (19mm)
- Override: Electrical (OR)

FEATURES

- Handle Packing, Main Seat, Stop Seat and Vacuum Breaker Molded from PERMEX® Rubber Compound for Chloramine resistance
- User-friendly, three-second flush delay and Courtesy Flush™ override button
- “Low Battery” Flashing LED
- Sweat solder adapter with cover tube and cast wall flange with set screw
- Solar Powered. The sensor assembly is powered by a solar cell that will harvest power from the artificial indoor light (incandescent, fluorescent or LED), and use it as the energy source. The solar cell can provide approximately 100% power with 650 illuminance (lux).
- Four (4) Size AA Battery Back-up Power Source
- Synthetic rubber seals for chloramine resistance
- Infrared Sensor with Multiple-focused, Lobular Sensing Fields for high and low target detection
- Fixed metering bypass and no external volume adjustment to ensure water conservation
- Fixed Metering Bypass and No External Volume Adjustment to Ensure Water Conservation
- Engineered Metal Cover with replaceable Lens Window
- ADA Compliant Sloan Solis® Solar Powered Infrared Sensor for automatic “No Hands” operation
- 3/4" IPS screwdriver Bak-Chek® angle stop with vandal resistant stop cap
- User-friendly, three-second flush delay and Courtesy Flush® override button
- High Copper, low zinc brass castings for dezincification resistance
- Valve body, Cover, Tailpiece and Control Stop shall be in compliance with ASTM Alloy Classification for Semi-Red Brass
- Valve shall be in compliance to the applicable sections of ASSE 1037



COMPLIANCES & CERTIFICATIONS



(ADA Compliant, BAA Compliant, BREEAM Materials Credit, BREEAM Water Credit, Carbon Neutral, cUPC Certified, cUPC Green Certified, EPD, Green Globes Materials & Resources Credit, Green Globes Water Credit, HPD, LEED Materials & Resources EPD Credit, LEED Materials & Resources HPD Credit, LEED V4 Water Efficiency Credit, Satisfies LEED Credits, WaterSense Listed, WELL Building Standard)

RECOMMENDED SPECIFICATION

Valve Body, Cover, Tailpiece and Control Stop shall be in conformance with ASTM Alloy Classification for Semi- Red Brass. Valve shall be in compliance with the applicable sections of ASSE 1037 and ANSI/ASME 112.19.2.

ELECTRICAL SPECIFICATIONS

- Battery Life: 6 years

VALVE OPERATING PRESSURE (FLOWING)

15-80 PSI (103-552 kPa). Specific fixtures may require greater minimum flowing pressure - consult manufacturer requirements.

DOWNLOADS

- [Solis 8100 HET Series Installation Instructions](#)
- [Solis 8100 Series \(Spanish\) Installation Instructions](#)
- [Control Stop Repair and Maintenance Guide](#)
- [Flush Connections Flanges Repair and Maintenance Guide](#)
- [Tail Piece Repair and Maintenance Guide](#)
- [Concealed Solis Repair and Maintenance Guide](#)
- [Exposed Solis Repair and Maintenance Guide](#)
- [Flushometer Pressure gauges](#)
- [Additional Downloads](#)



VIDEOS

 PVD Special Finishes

NOTES

All information contained within this document subject to change without notice.

Looking for other variations of the SOLIS 8186 product? [View the general spec sheet with all options.](#)

[Find a compatible urinal](#) for this flushometer.

[Find a compatible water closet](#) for this flushometer.

WaterSense compliant when used with a WaterSense compliant fixture



ROUGH-IN

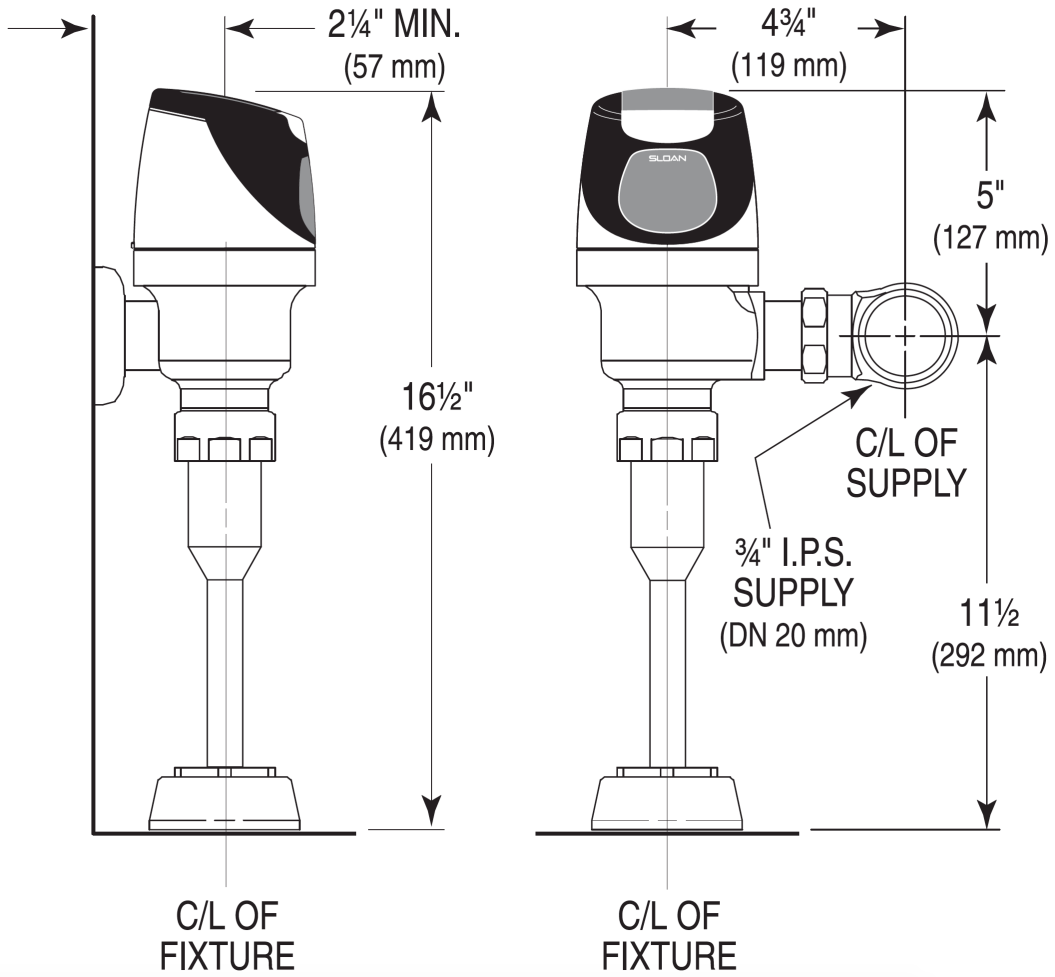

**SLOAN
REPAIR
.COM**

TOLL FREE: 800-442-6622
www.store.sloanrepair.com