

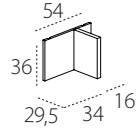

BOOKSHELVES

TIPE A

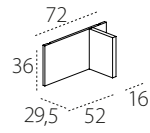
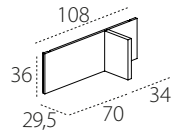

TIPE B

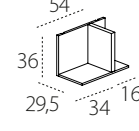
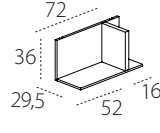
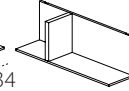
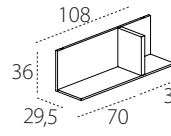

TIPE C

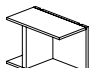
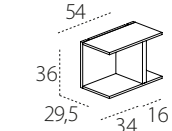
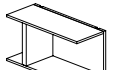
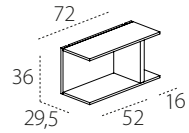
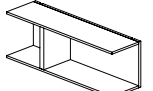
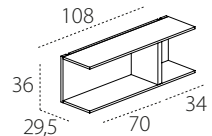

VERTICAL AND HORIZONTAL OPEN WALL ELEMENTS

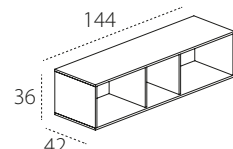
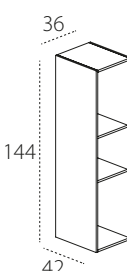
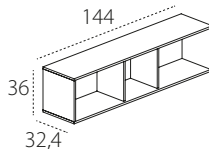
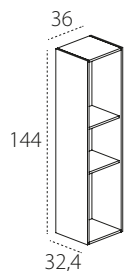
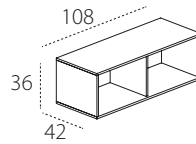
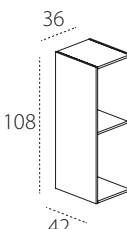
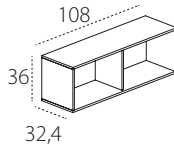
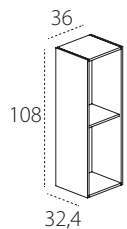
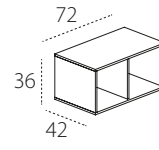
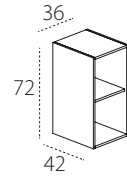
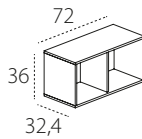
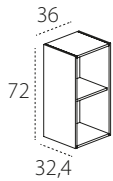
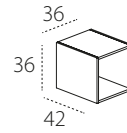
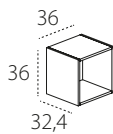



VERTICAL WALL ELEMENTS WITH HINGED DOOR

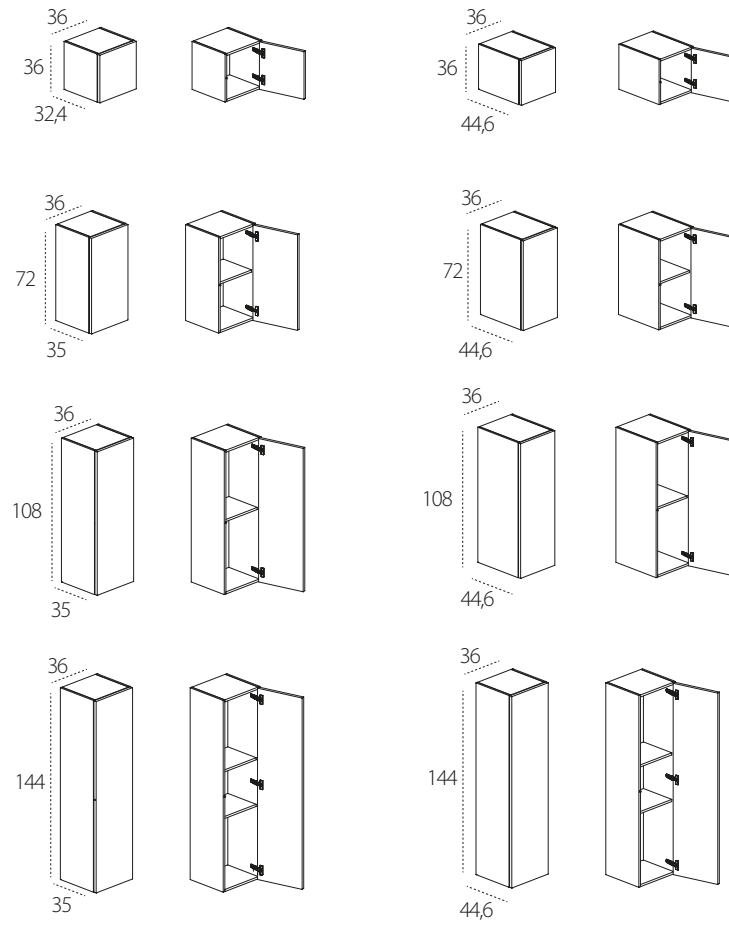

HORIZONTAL WALL ELEMENTS WITH FLAP DOOR

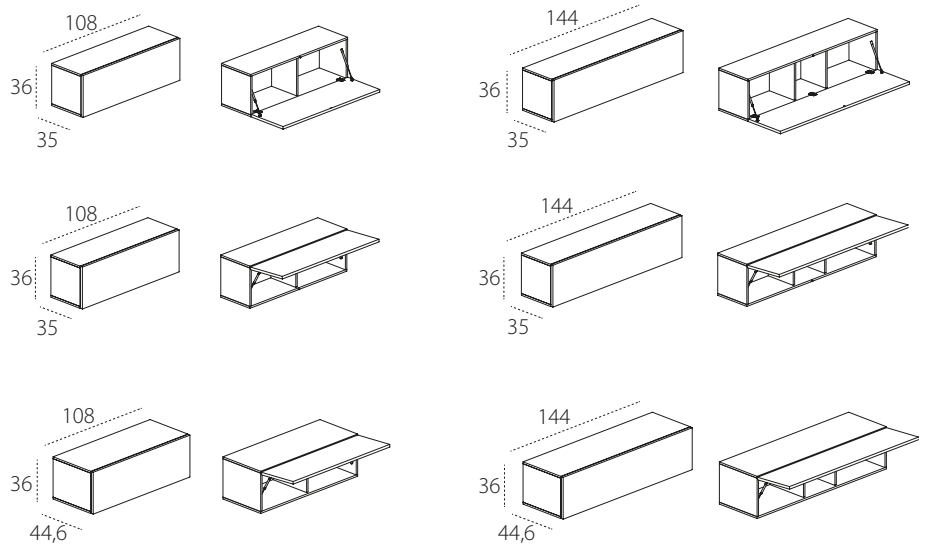

SUSPENDED ELEMENTS WITH DRAWERS

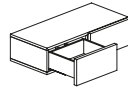
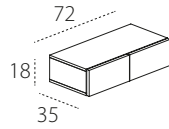
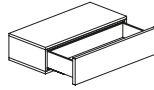
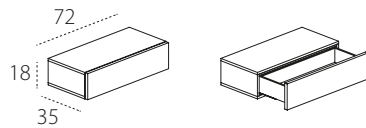

Drawer LHF - fixed panel RHF.
To be used beside sofas with armrest wider than 6 cm.

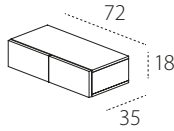
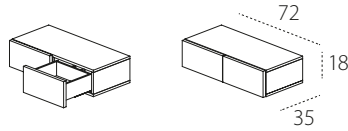

Drawer RHF - fixed panel LHF.
To be used beside sofas with armrest wider than 6 cm.

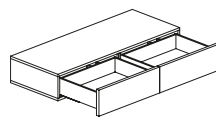
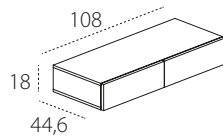
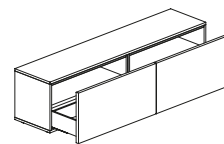
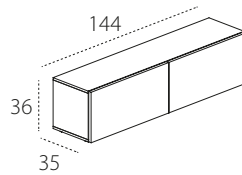
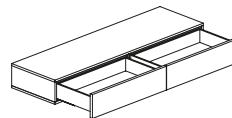
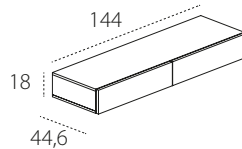
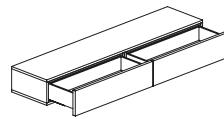
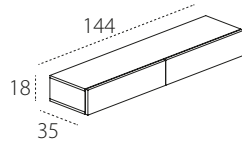

SUSPENDED ELEMENTS WITH DRAWERS AND FLAP DOOR – WITH CABLES ACCESS

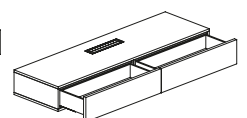
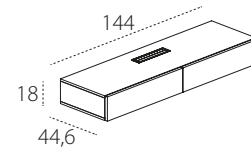
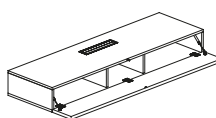
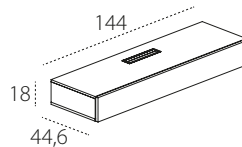
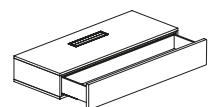
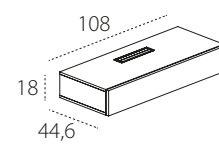
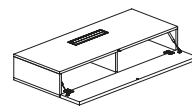
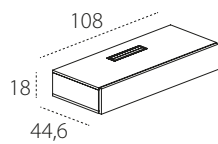

FLOOR BOOKSHELF

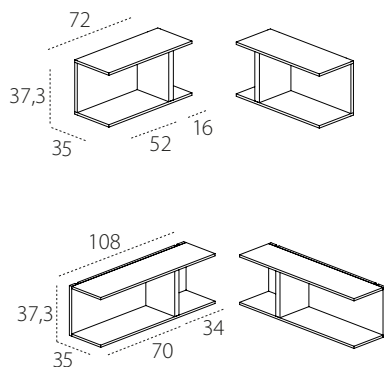
**TECHNICAL INFORMATION**

Modular system that allows free combination of bookshelf elements, wall elements with or without door, floor and suspended elements.

They can be integrated in the Living & Young system programs.

AVAILABLE FINISHES

BOOKSHELVES - 3 DIFFERENT TYPOLOGIES CALLED A, B, C, COMPOSED OF SHELF, SIDE PANEL AND BACK PANEL - Melamine white, oak sabbia, and lacquered as per Cleicoloursystem. Wooden finishes: walnut wood, oak wood.

VERTICAL AND HORIZONTAL WALL ELEMENTS WITH HINGED OR FLAP DOOR, OR WITHOUT - Melamine white and lacquered as per Cleicoloursystem.

SUSPENDED ELEMENTS WITH DRAWERS - Melamine white, Melamine oak sabbia and lacquered as per Cleicoloursystem. Wooden finishes: walnut wood, oak wood.

SUSPENDED ELEMENTS WITH DRAWERS AND FLAP DOOR WITH CABLES ACCESS - Melamine white, oak sabbia and lacquered as per Cleicoloursystem. Wooden finishes: walnut wood, oak wood.

FLOOR BOOKSHELF - Melamine white, oak sabbia, and lacquered as per Cleicoloursystem. Wooden finishes: walnut wood, oak wood.