



## DESIGNS AND TEMPLATE DATA SHEET

WHEN YOU PURCHASE THE DESIGNS AND TEMPLATES  
YOU RECEIVE ALL DESIGNS AND TEMPLATES LISTED BELOW

WORK LIKE A PRO!

## SIGN TEMPLATES AND DESIGN ELEMENTS (FORMATTED AS .EPS & .PDF - ALL VECTOR AND READY TO EDIT)

SIGN TEMPLATES AND DESIGN ELEMENTS THAT WILL GIVE YOUR DESIGNS A  
CONSISTENT AND PROFESSIONAL LOOK THAT WILL IMPRESS YOUR CLIENTS!

### •SIGN TEMPLATES: (FOR DESIGNING AND PRESENTATIONS)

- Awning Templates
- Banner Templates
- Blank Templates
- Cabinet Templates
  - Pole Signs
  - Wall Signs
- Channel Templates
- Coroplast Templates
- Development Package Templates
- Door Vinyl Templates
- EDS LED Templates
- MDO Templates
- Monument Templates
- Post Panel Templates
- Pylon Templates
- Reader Templates
- Vehicle Magnets Templates
- Vehicle Wrap Templates
- Way Finding Templates

### •DESIGN ELEMENTS:

- Arrows
- Background Sky's
- Cars
- Landscaping
- Misc Clip Art
- People
- Sign Components
- Sign Schematics
  - Cabinet Sign Schematics
  - Channel Letter Sign Schematics
  - Misc Sign Schematics
- Surface Components
- Textures
  - Brick Textures
  - Fire Textures
  - Metal Textures
  - Stone Textures



FOR MORE INFO EMAIL US: [SUPPORT@SIGNSHOPSTARTERKIT.COM](mailto:SUPPORT@SIGNSHOPSTARTERKIT.COM)

# MDO BOARDS • 4"X4" POSTS

• MDO COMMON THICKNESS: 1/2" AND 3/4"

36" X 36"



48" X 48"



48" X 96"



96" X 48"



# WINDOW ETCHED VINYL



# BANNERS • GROMMETS

COMMON COLORS: ■ YELLOW -  WHITE

COMMON WEIGHT: 12oz, 13oz, 14oz, 15oz, 18oz

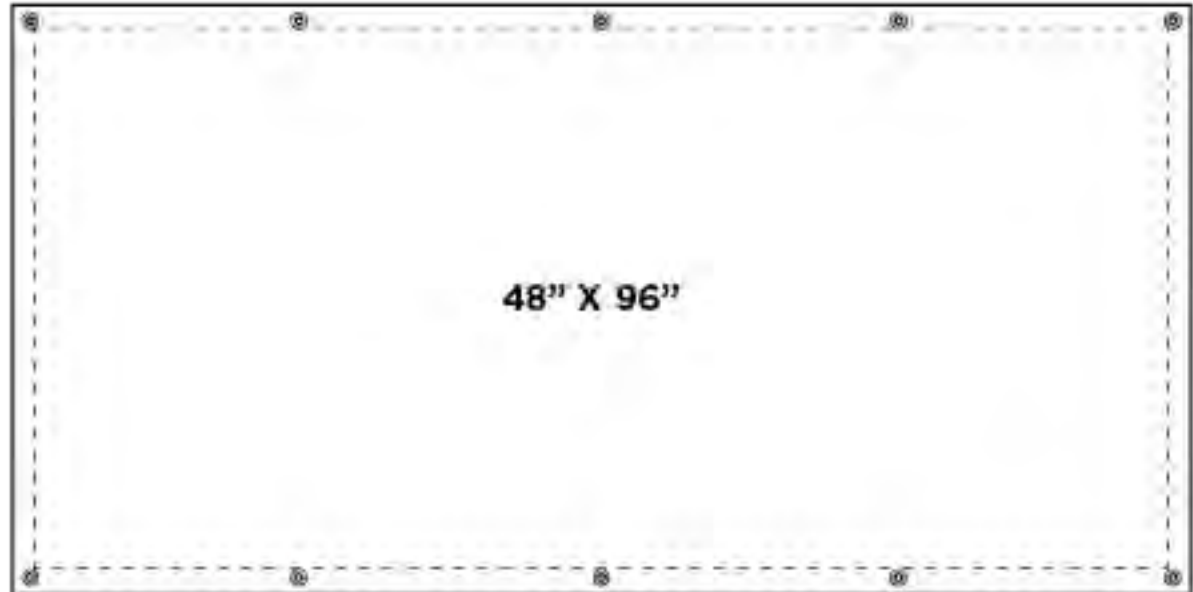

GROMMET- SILVER



GROMMET- GOLD



# HARDWARE

---



# STEEL POLE • ALUMINUM SIGNS W/ ROUNDED CORNERS



18" x 12"



24" x 18"



36" x 24"

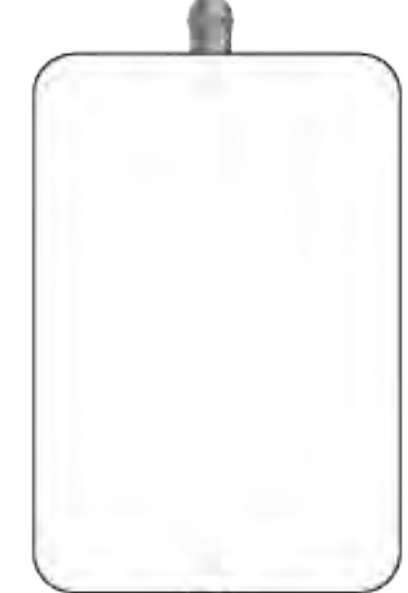

8' STEEL POLE



Note: Choose applicable option or enter variable information

**A** Reverse Channel Letters w/ Backplate LED, Raceway Mounted • Front View  
 SCALE: 0/0" = 1' 0" • For Production / For Presentation

**INTERNALLY ILLUMINATED REVERSE CHANNEL LETTERS**

**QUANTITY:** ONE (1)  
**Overall Height:** 0'-0"  
**Overall Length:** 0'-0"  
**Total Sq.Ft.:** 0.00 ft<sup>2</sup>  
**Face/Returns:** PMS/Wrisco COLOR  
**Backer Panel:** PMS/PAINT # COLOR NAME  
**Raceway:** PMS/PAINT # COLOR NAME  
**Illumination:** LED Color

**NOTES:**  
 • Individually Mounted  
 • WHITE interiors for increased illumination  
 • All paint two-stage automotive acrylic

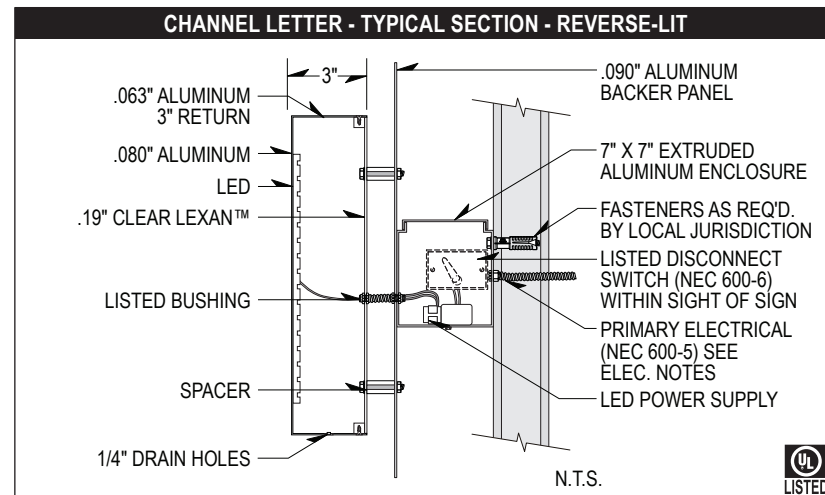

**ELECTRICAL NOTES**  
 Sign Company DOES NOT provide primary electrical to sign.  
 Power to the sign must be done by a licensed electrical contractor or licensed electrician.  
 Each sign must have:  
 1. A minimum of one dedicated 120V 20A circuit  
 2. Junction box installed within 6 feet of sign  
 3. Three wires: Line, Ground, Neutral

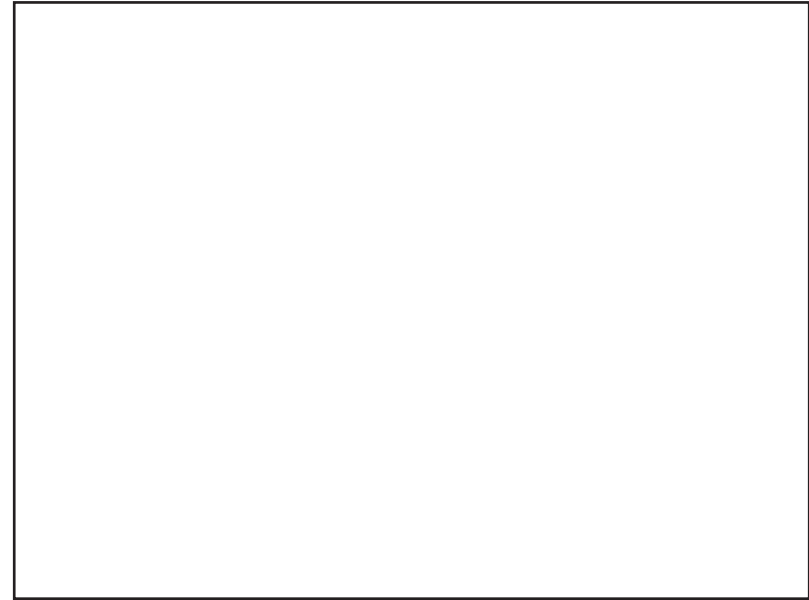
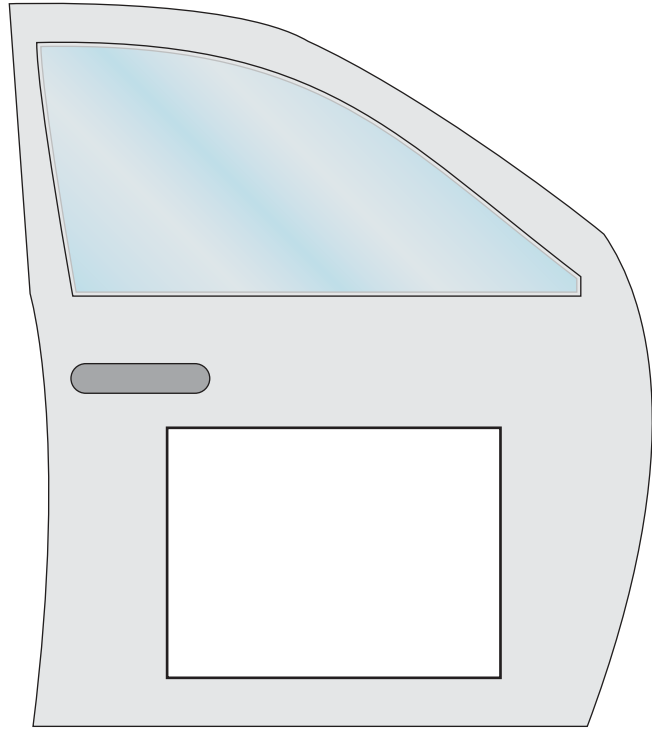

Note: Replace all information in red below using your numbering system and client information

<p><b>PLACE YOUR SIGN COMPANY LOGO HERE</b></p>	<p><b>Client Name:</b> Client Name</p>	<p><b>Start Date:</b> 00/00/0000  <b>Last Revision:</b> 00/00/0000  <b>Job#:</b> 00000  <b>Drawing#:</b> 00000a.v1.s1 / e1  <b>Page:</b> 1 of 2</p>	<p>• ..... Client Approval</p> <p>• ..... Landlord Approval</p>	<p><b>Sales Rep:</b> Name</p> <p><b>Designer:</b> Name</p> <p>MEMBER INTERNATIONAL SIGN ASSOCIATION</p> <p>UL LISTED</p>
	<p><b>Location:</b> Address</p>			

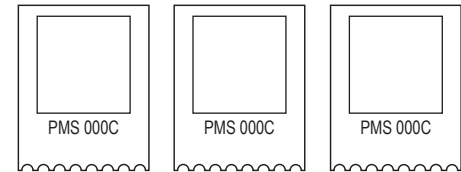

**A** Door Magnet \_\_\_\_\_



	<b>Client Name:</b> Client Name  <b>Location:</b> Address	<b>Start Date:</b> 00/00/0000 <b>Last Revision:</b> 00/00/0000 <b>Job#:</b> 00000 <b>Drawing#:</b> 00000a.v1.s1 / e1 <b>Page:</b> 1 of 2	• ..... Client Approval  • ..... Landlord Approval	<b>Sales Rep:</b> Name <b>Designer:</b> Name <small>MEMBER</small>  <small>INTERNATIONAL SIGN ASSOCIATION</small>  <small>LISTED</small>
--	---	--	--	--



**Note: Choose applicable option or enter variable information**

**A** Front-Lit, Plex-Face Channel Letters w/ LED, Raceway Mounted • Front View  
 SCALE: 0/0" = 1' 0" • For Production / For Presentation

**INTERNALLY ILLUMINATED PLASTIC FACE CHANNEL LETTERS**

**QUANTITY:** ONE (1)  
**Overall Height:** 0'-0"  
**Overall Length:** 0'-0"  
**Total Sq.Ft.:** 0.00 ft<sup>2</sup>  
**Returns:** PMS/Wrisco COLOR  
**Backs:** PMS/Wrisco COLOR  
**Trimcap:** COLOR  
**Face:** #0000 COLOR  
**First-surface translucent vinyl:**  
 Vinyl Manufacturer, Part # and Color  
**Raceway:** PMS/PAINT # COLOR NAME  
**Illumination:** LED Color

**NOTES:**  
 • WHITE interiors for increased illumination  
 • All paint two-stage automotive acrylic

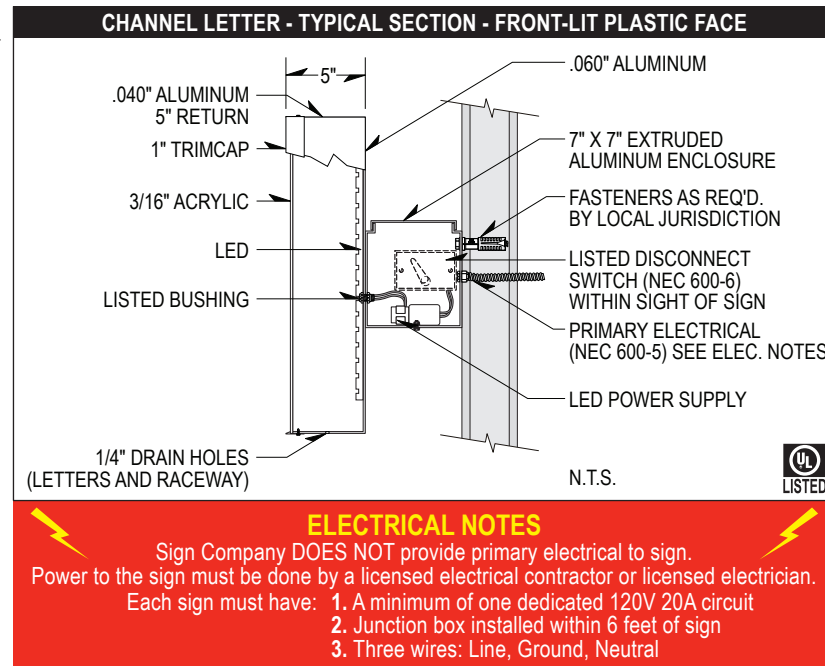

**Note: Replace all information in red below using your numbering system and client information**

<p><b>PLACE YOUR SIGN COMPANY LOGO HERE</b></p>	<p><b>Client Name:</b>                  Client Name</p>	<p><b>Start Date:</b> 00/00/0000  <b>Last Revision:</b> 00/00/0000  <b>Job#:</b> 00000  <b>Drawing#:</b> 00000a.v1.s1 / e1  <b>Page:</b> 1 of 2</p>	<p>• .....                  Client Approval</p> <p>• .....                  Landlord Approval</p>	<p><b>Sales Rep:</b>                  Name</p> <p><b>Designer:</b>                  Name</p> <p>MEMBER                  INTERNATIONAL SIGN ASSOCIATION                  LISTED</p>
	<p><b>Location:</b>                  Address</p>			

# Illuminated Monument Sign • 4' X 8' Large A Frame Cabinet, Lexan Face • Client Name • City • State

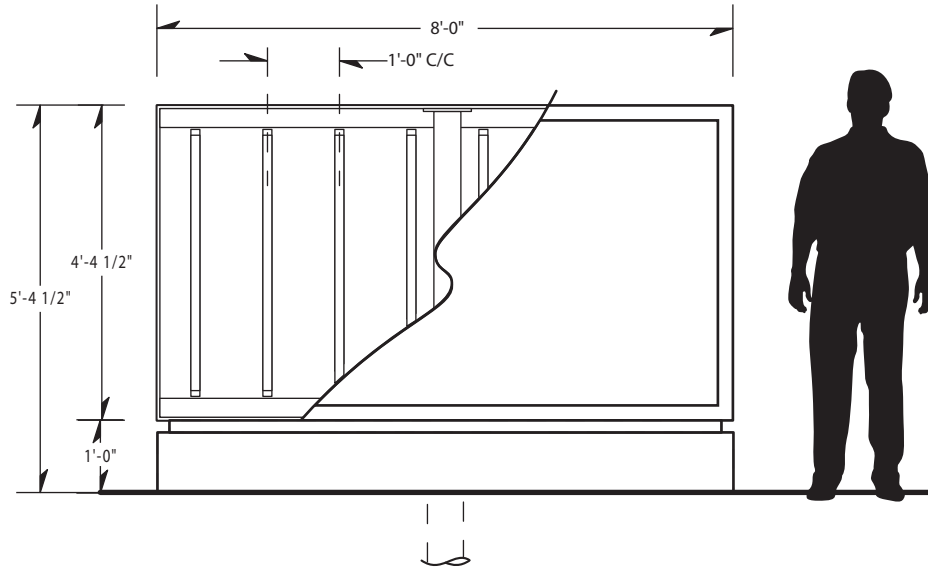

## SPECIFICATIONS FOR FABRICATION AND INSTALLATION:

- Internally illuminated monument sign built to UL specifications
- Quantity: one (1)
- Extruded aluminum construction type: Large A (with air vents)
- Overall length of sign cabinet: 8' - 0" / Overall height of sign cabinet: 4' - 4 1/2"
- Overall height above grade: 5' - 4 1/2"
- Total square feet: 35.00
- Cabinet depth: 13 1/2"
- Retainer size: 2 1/2"
- Face type: Lexan with first-surface translucent vinyl graphics
- Mounting method: single pole (6.625" pole pocket) with pole cover
- Illuminated with high output fluorescent lamps / ballasts (12" centers)
- Primary electrical requirement:
  - ▣ 120 volt (installed within six feet of sign by others)
  - ▣ Timer or photo-cell (installed by others)

## OTHER COMPONENTS / SPECIAL CONSTRUCTION CONSIDERATIONS:

**A** D.F. Illuminated Pole Sign • Cabinet Detail  
Scale 3/8" = 1' For Production

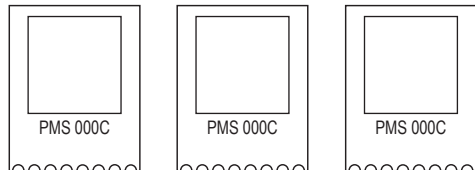

## COLOR SPECIFICATIONS:

- ▣ Cabinet painted with two-stage automotive acrylic
- Cabinet Color : PMS color
- Pole Cover Color : PMS color
- Interior painted for increased illumination: white
- Face graphics: vinyl # / heat transfer graphics / Flexigrip™ paint / other
- Face colors: color(s)

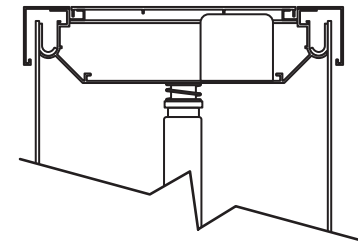

**A** Illuminated Cabinet • Typical Section  
Scale 1 1/2" = 1' For Production

**Client Name:**  
Client Name

**Location:** ▣  
Address  
▣

**Start Date:** 00/00/0000  
**Last Revision:** 00/00/0000  
**Job#:** 00000  
**Drawing#:** 00000a.v1.s1 / e1  
**Page:** 1 of 2

- .....  
Client Approval
- .....  
Landlord Approval

**Sales Rep:**  
Name  
**Designer:**  
Name



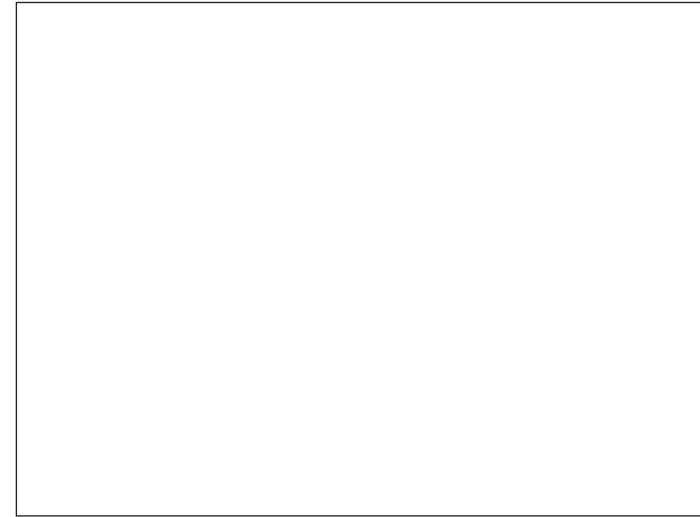
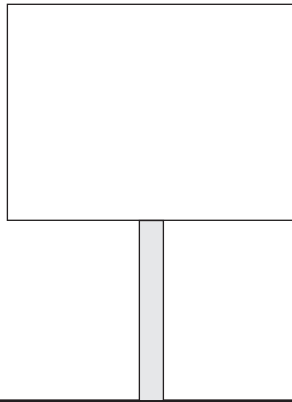
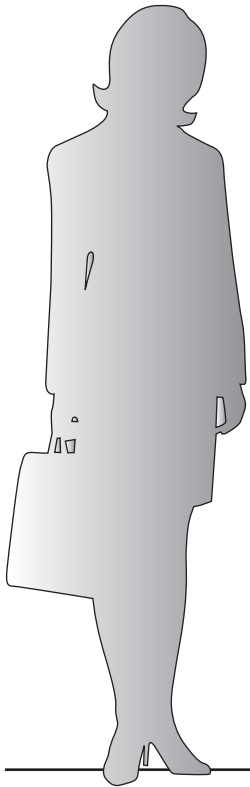

A Sign Type \_\_\_\_\_

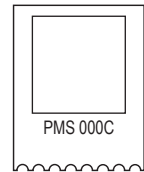
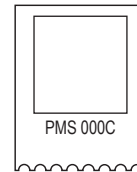
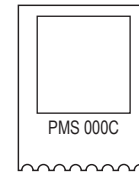

**Client Name:**  
Client Name

**Location:**  
Address

**Start Date:** 00/00/0000  
**Last Revision:** 00/00/0000  
**Job#:** 00000  
**Drawing#:** 00000a.v1.s1 / e1  
**Page:** 1 of 2

- .....  
Client Approval
- .....  
Landlord Approval

**Sales Rep:**  
Name  
**Designer:**  
Name



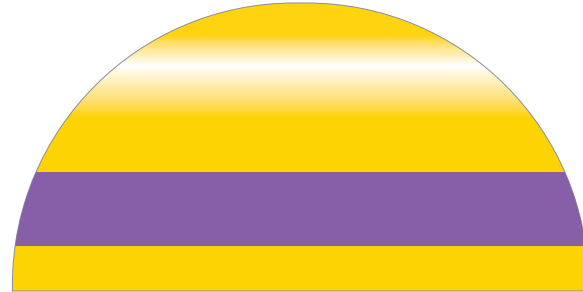

**AWNING WITH TUBULAR ALUMINUM SKELETON, FABRICATE AND INSTALL:**

- INTERNALLY ILLUMINATED AWNING TO FOLLOW UL FABRICATION SPECIFICATIONS / NON-ILLUMINATED
- QUANTITY:
- OVERALL HEIGHT OF AWNING: 36" / 48" / 60" OVERALL LENGTH OF AWNING: 00' - 0"; OVERALL DEPTH OF AWNING 00"
- AWNING TO BE COOLEYBRITE FABRIC
- TEXT AND GRAPHICS: WHITE ERADICATED COPY & 3M PREMIUM TRANSLUCENT VINYL  
-PMS COLOR OR 3M PART # AND COLOR
- ILLUMINATION TO BE HIGH OUTPUT 600 MA FLOURESCENT LIGHTING THAT EXTENDS THE LENGTH OF THE AWNING
- AWNING TO BE DIRECTLY MOUNTED TO WALL WITH 3/8" FASTENERS
- AWNING FACE TO READ:

SINGLE ROW OF  
DOUBLE BULB  
FLOURESCENT  
ILLUMINATION

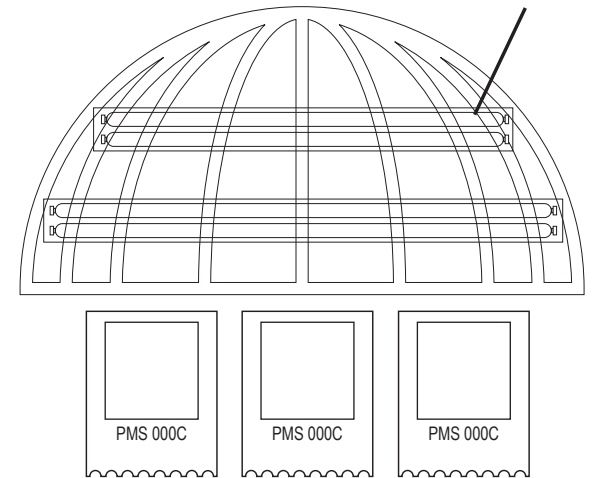

**A** Dome Awning \_\_\_\_\_

**PLACE YOUR  
SIGN COMPANY  
LOGO HERE**

**Client Name:**  
Client Name

**Location:**  
Address

**Start Date:** 00/00/0000  
**Last Revision:** 00/00/0000  
**Job#:** 00000  
**Drawing#:** 00000a.v1.s1 / e1  
**Page:** 1 of 2

.....  
Client Approval  
  
.....  
Landlord Approval

**Sales Rep:**  
Name  
**Designer:**  
Name



3-WAY

ALL WAY



2-WAY

4-WAY

TOW AWAY ZONE

WRONG WAY



DO NOT ENTER

SPEED CHECKED BY RADAR

SPEED LIMIT 50



CROSS TRAFFIC DOES NOT STOP

RIGHT TURN ONLY

LEFT TURN ONLY

NO U TURN

DO NOT PASS

NO RIGHT TURN

NO LEFT TURN

NO U TURN

NO RIGHT TURN

NO LEFT TURN

REDUCED SPEED AHEAD

