

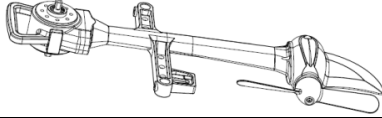

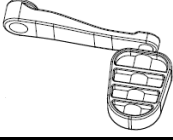

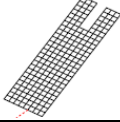















# Pedal Drive Unit Assembly Instructions

## 1. Part Checklist

No.	Item		Photo	Qty
1	Pedal Drive Unit			1
2	Foot pedal with ring & screws	2-a		2
		2-b		2
		2-c		2
		2-d		2
		2-e		3
3	Baffle board with screws	3-a		1
		3-b		2
4	Connector for pedal & kayak body	4-a		1
		4-b		1
		4-c		2
5	Lock for pedal & kayak body	5-a		1
		5-b		2
		5-c		2
		5-d		1
6	Tools	6-a	M4 Screwdriver 	1
		6-b	M5 Screwdriver 	1
		6-c	M6 Screwdriver 	1
7	Extra parts			2
				2
				2
				2

## 2. Assembly of pedal drive unit

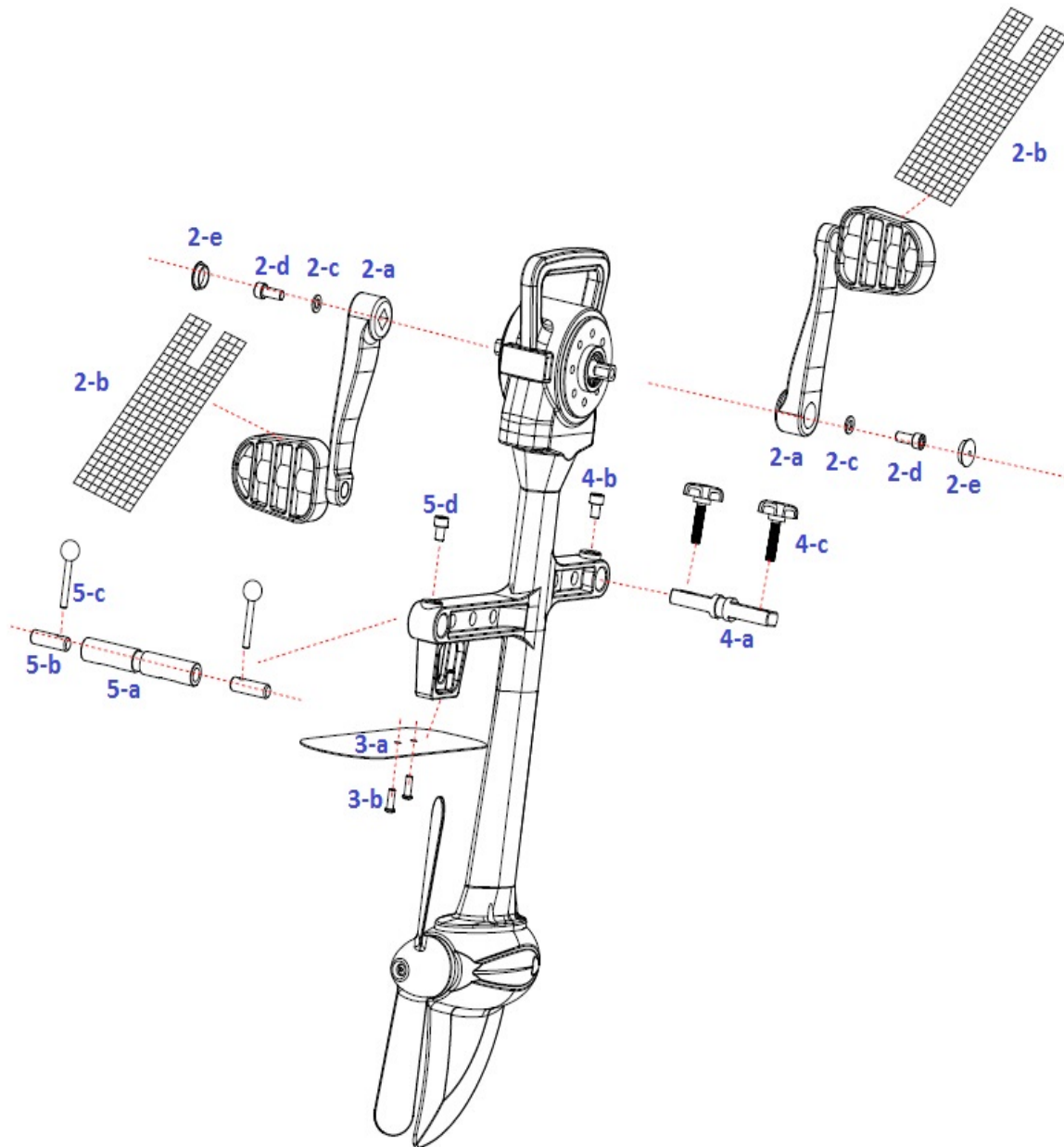

**Step 1:** Connect 2 x foot pedal kit by M6 screwdriver. (Note: Left and right ones are the same)

**Step 2:** Screw Baffle board using M6 screwdriver.

**Step 3:** Screw connector kit using M6 screwdriver.

**Step 4:** 1) Screw part (5-a) with propel body using M6 screwdriver.

2) Insert 2 x (5-b) into part (5-a), then screw part (5-c) with 5-b.

### Finished product

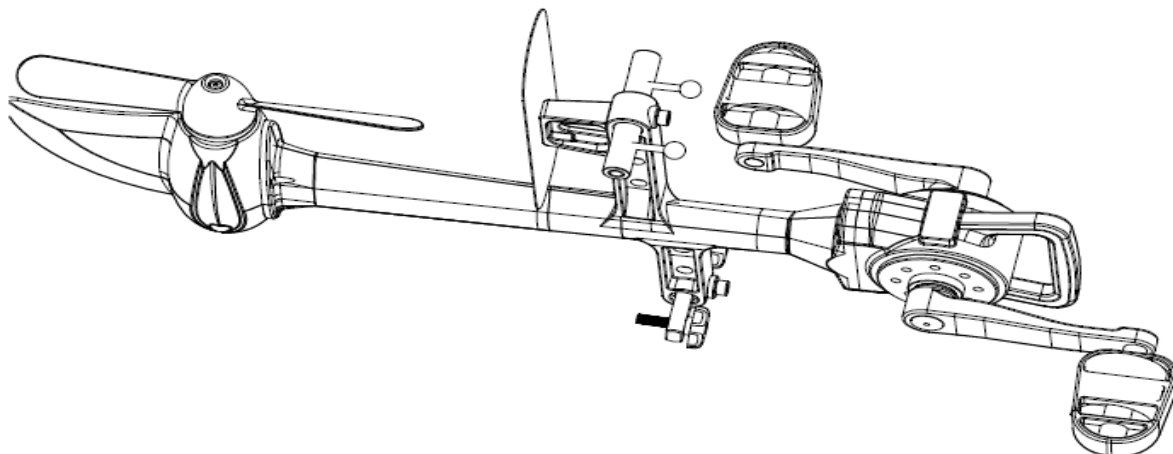

### 3. Installation of pedal unit onto kayak

Before kayaking, screw on the pedal unit to the kayak as per drawing below and keep the whole pedal on the top of middle cover.

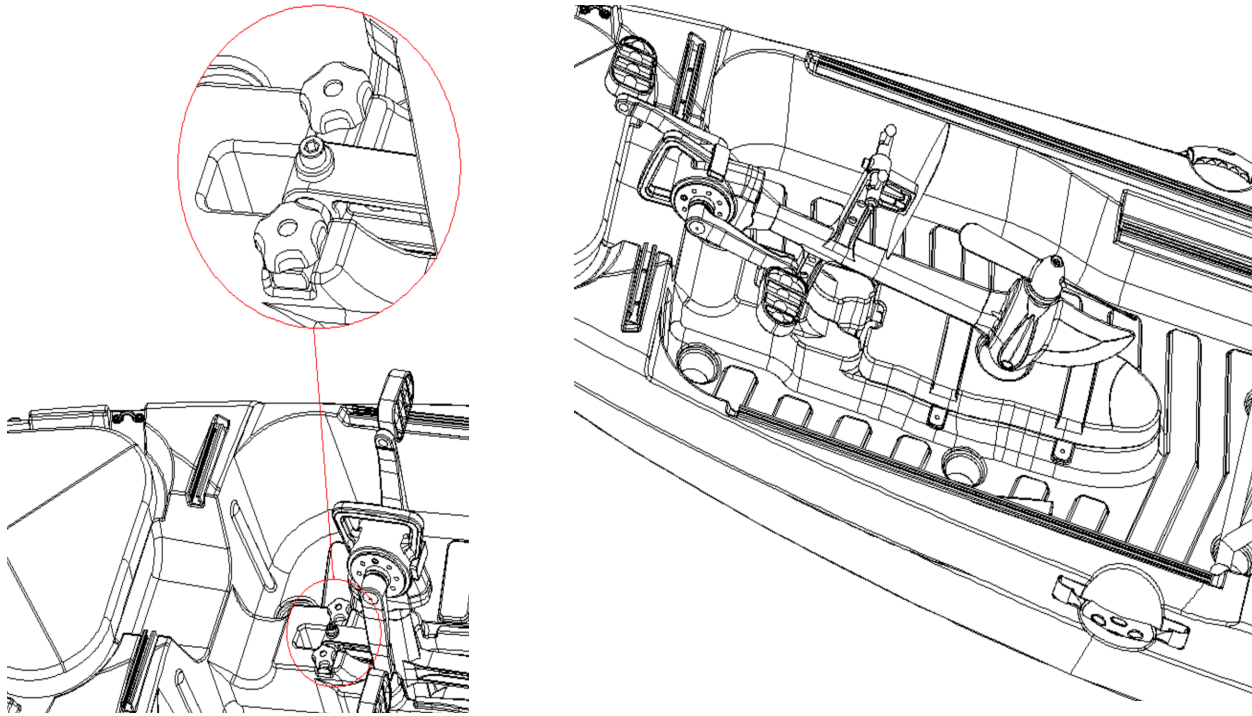

Once in deep enough water, remove the black cover and lower the pedal drive unit down, locking the bolt part (5-c) into place (as illustrated below). Then close the cover to keep kayaking.

