



Savi® Office WO300/WO350 Wireless Headset System

with Optional HL10™ Lifter

User Guide

Welcome

Congratulations on purchasing your new Plantronics product. This guide contains instructions for setting up and using your Savi Office WO300/WO350 (WO1 Base and WH300/WH350 Headset) Wireless Headset System. Please refer to the separate [safety instructions](#) for important product safety information prior to installation or use of the product.

Refer to the CD for Animated Set Up instructions.

Contents

1 Package Contents and Features	4
1.1 Savi Base	4
1.2 Savi Headset.....	5
1.3 HL10 Lifter (Optional).....	6
2 Base Set Up	7
2.1 Attaching Charge Cradle to Base	7
2.2 Connecting Base to Desk Phone.....	7
2.3 Connecting Power Supply to Base.....	7
2.4 Positioning Base.....	7
3 Headset Set Up	8
3.1 Adjust the Headband	8
3.2 Adjust the Mouthpiece.....	8
3.2 Docking and Charging the Headset.....	8
4 Configure and Test Call	9
4.1 Checking Configuration	9
4.2 Making a Test Call with Desk Phone	9
5 Lifter Set Up (Optional)	10
5.1 Installing Lifter.....	10
5.2 If You Do Not Hear a Dial Tone	10
5.3 Additional Parts (if required).....	11
6 PC Set Up	12
6.1 Installing USB Cable.....	12
6.2 Installing Plantronics Software	12
6.3 Making a Test Call with PC.....	12
7 Using Your Savi Office Wireless Headset System	13
Powering up Headset	13
Placing, Answering and Ending Calls with Desk Phone	13
Placing, Answering and Ending Calls with PC	14
Switching Between Desk Phone and PC Audio	14
Mixing Desk Phone and PC Audio	14
Muting the Headset	15
Subscribing a Master Headset	15
Conferencing In Up to Three Additional Headsets	15
Setting Default Line to Desk Phone or PC.....	16
Toggling On/Off Over-the-Air Subscription.....	16
Setting the Range	16
Ending Subscription	16
Desk Phone and PC Talk Buttons “Rules to Live By”	16
Subscription Button Indicator Light.....	16
Desk Phone and PC Talk Buttons Indicator Lights.....	16
Talk Time.....	17
Checking Headset Battery Level	17
Headset Call Control Button Functions	17
Placing the Headset in Sleep Mode	17
Headset Indicator Light	17
Headset Tones.....	17
8 Plantronics Software Platform	18
Softphone Support	18
Plantronics Update Manager.....	18
Plantronics Control Panel	19
Battery Life	19
Devices Tab	19
Applications Tab	20
Preferences Tab.....	21
About Tab	21
Help for Device Settings - USB Adapter	22
Help for Device Settings - Advanced	22
9 Troubleshooting and Common Questions	23

1 Package Contents and Features

1.1 Savi WO1 Base

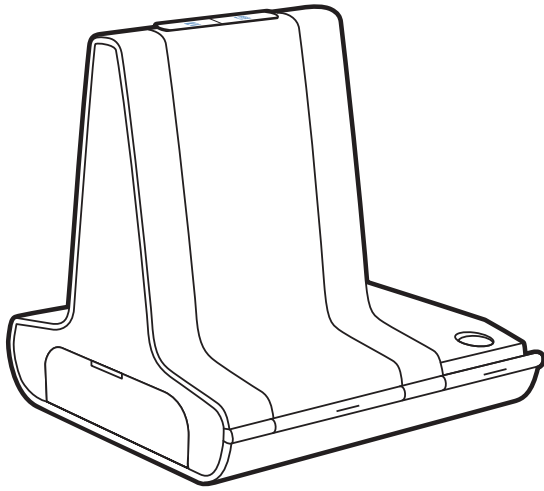

Base

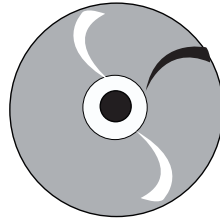

CD includes:

- Plantronics Software
- Animated Setup Guide
- Complete User Guide

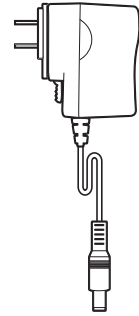

Base Power Supply

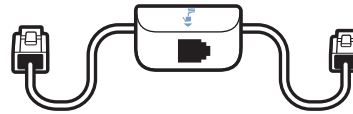

Telephone Interface Cable

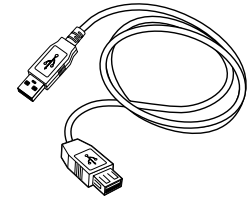

USB Cable

Savi WO1 Base Features

PC Talk Button
Indicator Light
Desk Phone Talk Button
Indicator Light

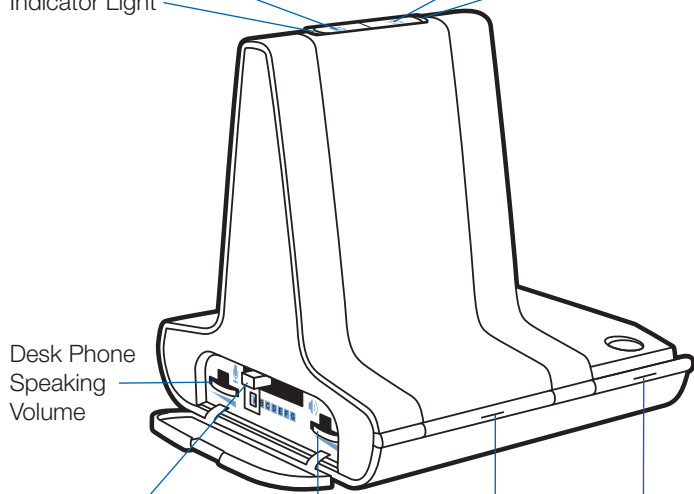

Desk Phone Speaking Volume
Configuration Switch
Desk Phone Listening Volume
Subscription Button and Indicator Light
Charging Indicator Light

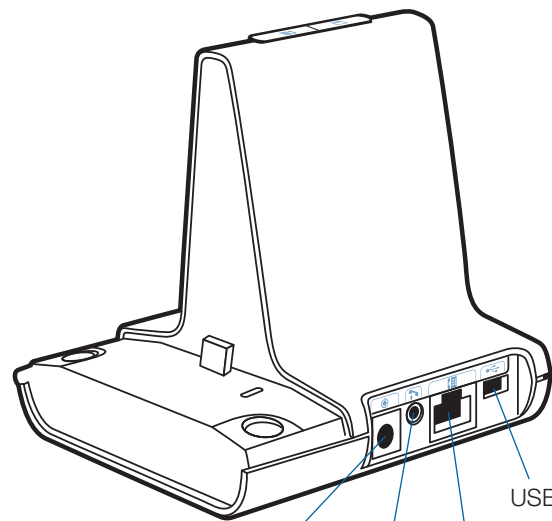

Power Jack
Handset Lifter Jack
Telephone Interface Cable Jack
USB Port

1.2 Savi Headset



WH300 Headset
(Monaural)



WH350 Headset
(Binaural)

(One model included in each package - both models shown.)

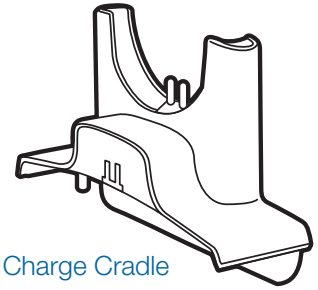

Charge Cradle

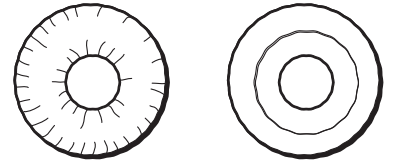

Ear Cushions

Savi WH350 Headset Features

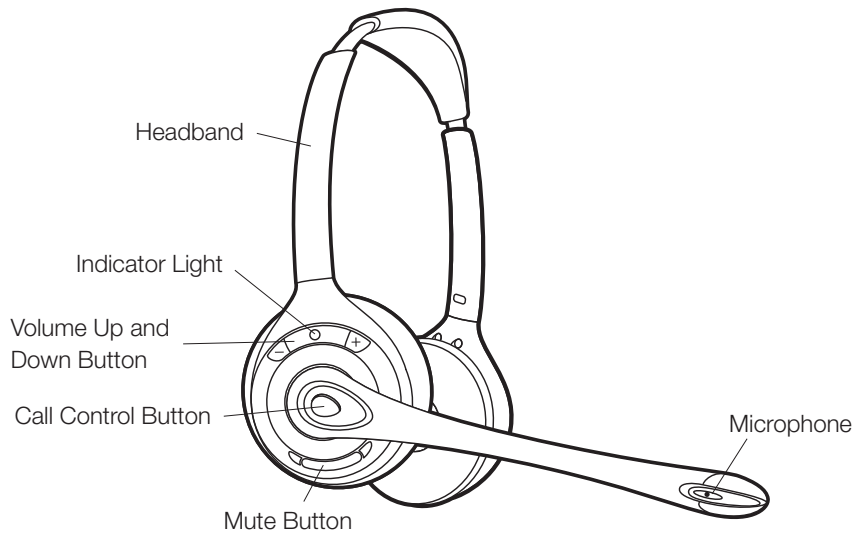

1.3 HL10 Lifter (Optional)

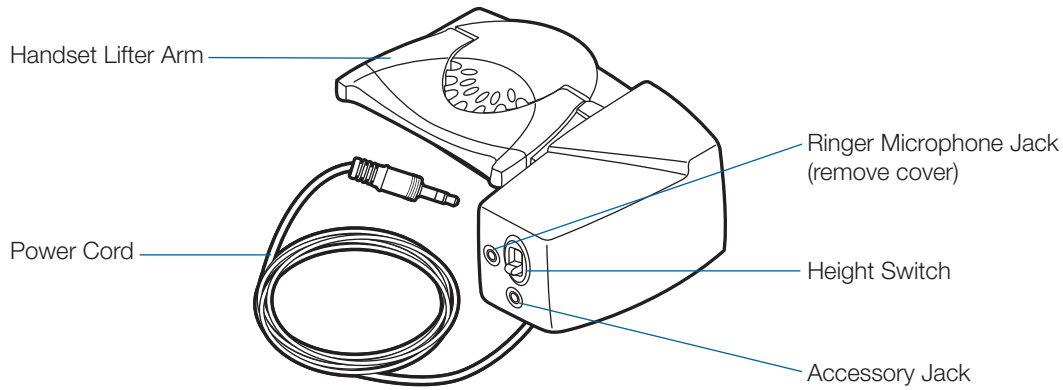

HL10 Lifter

Additional HL10 Lifter Parts (If Required)

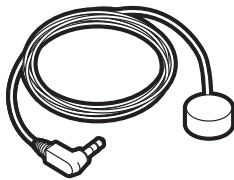

Ringer Microphone

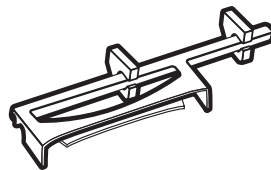

Extender
Arm



For Nortel i2004
phones only

2 Base Set Up

2.1 Attaching Charge Cradle to Base

- 1 **Connect the headset charge cradle to the base.** Push firmly on the cradle until the cradle snaps in to place.

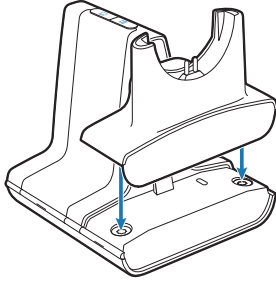

2.2 Connecting Base to Desk Phone

- 1 **Connect the telephone interface cable to the telephone interface cable jack on the base.**
- 2 **Disconnect the handset coil cord from the desk phone.**
- 3 **Connect the telephone interface cable to the now open handset port on the desk phone.**
- 4 **Connect the handset coil cord to the telephone interface cable junction box.**
- 5 **Place the handset back on the telephone cradle.**

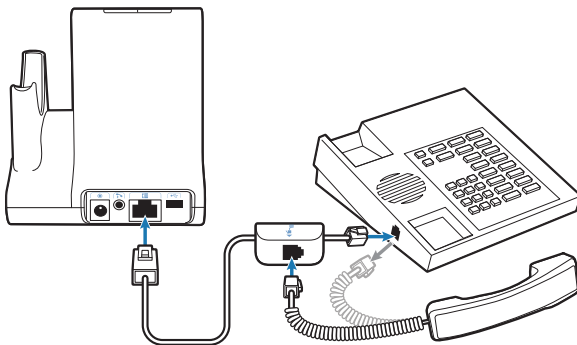

2.3 Connecting Power Supply to Base

- 1 **Connect the base power supply into the power jack on the base.**
- 2 **Connect the power supply to outlet.**

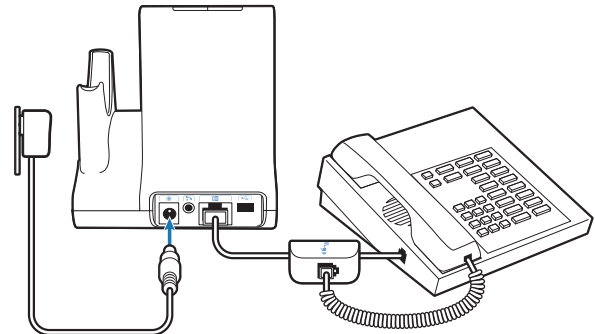

2.4 Positioning Base

The minimum recommended separation between your desk phone and the base is 6 inches.

The minimum recommended separation between the base and computer is 12 inches. Incorrect position can cause noise and interference problems.

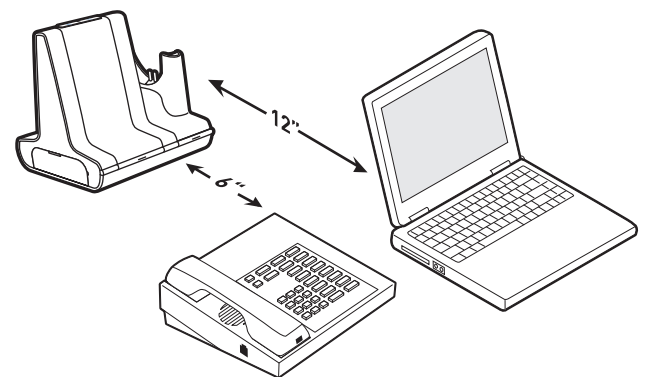

NOTE If your phone has a built-in headset port, you should only use the headset port if you will not be using the HL10 lifter. In this configuration, you must press both the headset button on your phone and the call control button on the headset to answer or end calls.

3 Headset Set Up

3.1 Adjust the Headband

- 1 To adjust the headband, lengthen or shorten the band until it fits comfortably.** Position the headset receivers so that the foam cushions sit comfortably over the center of your ears.
- 2 On the WH300, position the stabilizer T-bar above your ear.**
- 3 For a tighter fit, gently pull the opposite ends of the headband inward as shown.**

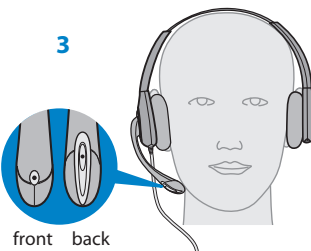
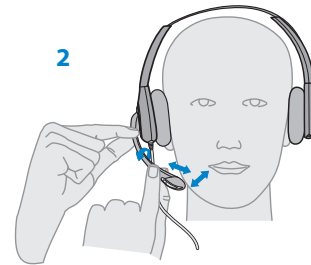
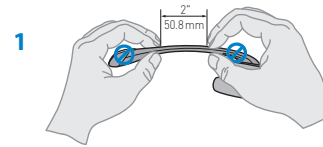
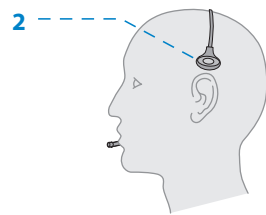
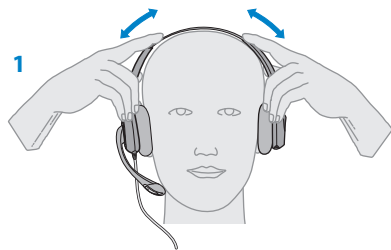

3.2 Adjust the Mouthpiece

- 1 Carefully bend and shape the boom with both hands as shown.** Avoid bending or twisting the boom near the microphone or earpiece.
- 2 Position the click-stop turret and boom so that the microphone is two finger-widths from the corner of your mouth.**
- 3 Make sure the front of the microphone faces your mouth.** If necessary, twist the microphone slightly so it's in the proper position. Do not use forceful twisting motions or try to turn the microphone completely around.

3.3 Docking and Charging the Headset

- 1 Gently push the headset into the charge cradle.**
The charging indicator light on the base will flash green to indicate that the headset battery is charging.
- 2 Charge for at least 20 minutes prior to the first use.**
A full charge takes 3 hours. The power indicator light will turn solid green.

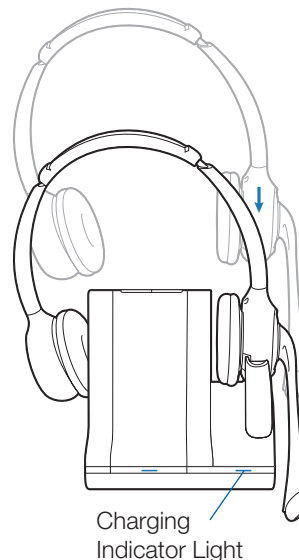

CHARGING TIME	
20 min	
Minimum charge before first use	
3 hours	
Full charge	

4 Configure and Test Call

4.1 Checking Configuration

- 1 If your desk phone has a volume control set it to mid-range.
- 2 On the base, ensure the Configuration Switch is set to "A" and the Desk Phone Speaking Volume and Desk Phone Listening Volume are both set to 3.

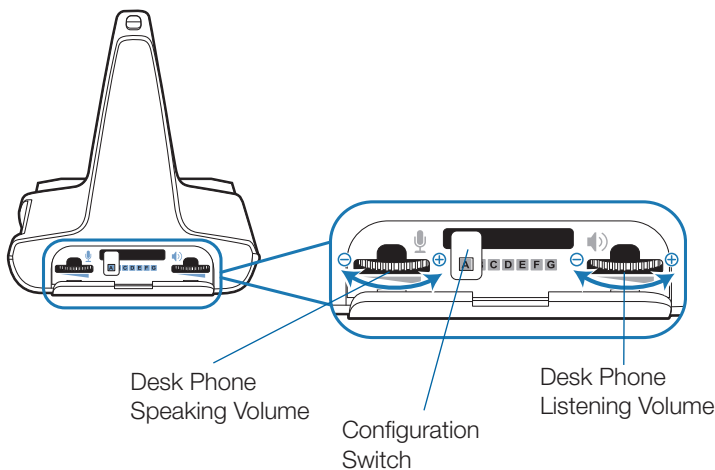

NOTE For most phones, these factory default settings will sound the best.

- 3 With your headset on, press the call control button on the headset.
- 4 Remove the headset from desk phone cradle.
- 5 Listen for a dial tone. If the dial tone sounds clear, press the call control button on headset and continue with [Step 4.2 Making a Test Call with Desk Phone](#).
- 6 You can fine tune the listening volume on the headset by pressing the volume up button [+] to increase the volume and the volume down button [-] to decrease the volume.

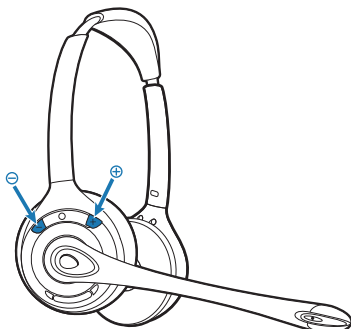

- 7 If the dial tone still does not sound clear, adjust the Configuration Switch until the dial tone sounds the best.

NOTE Multiple settings might work with your phone; however, only one is the optimal position.

- 8 Press the call control button on the headset to complete configuration.
- 9 Replace the headset into the desk phone cradle.

4.2 Making a Test Call with Desk Phone

- 1 If your desk phone has a volume control, ensure it is set to mid-range.
- 2 With your headset on, press the call control button on the headset.
- 3 Remove the headset from desk phone cradle.
- 4 Dial the number using your desk phone.
- 5 If the listening volume is too loud or too soft, adjust the listening volume on the headset by pushing the call control button up to increase the volume and pushing down to decrease the volume.
- 6 If the listening volume is still too loud or too soft adjust the Desk Phone Listening Volume on the base. A setting that is too high can produce an uncomfortable echo for you.
- 7 If the speaking volume is too loud or too soft for your listener, adjust the Desk Phone Speaking Volume on the base to the best setting for your listener. A setting that is too high can produce an uncomfortable echo for you and a distorted sound for you listener.
- 8 Press the call control button on the headset to end the test call.
- 9 Replace the headset into the desk phone cradle.



For your safety, do not use headset at high volumes for extended periods of time. Doing so can cause hearing loss. Always listen at moderate levels. For more information on headsets and hearing visit: plantronics.com/healthandsafety.

5 Lifter Set Up (Optional)

5.1 Installing Lifter

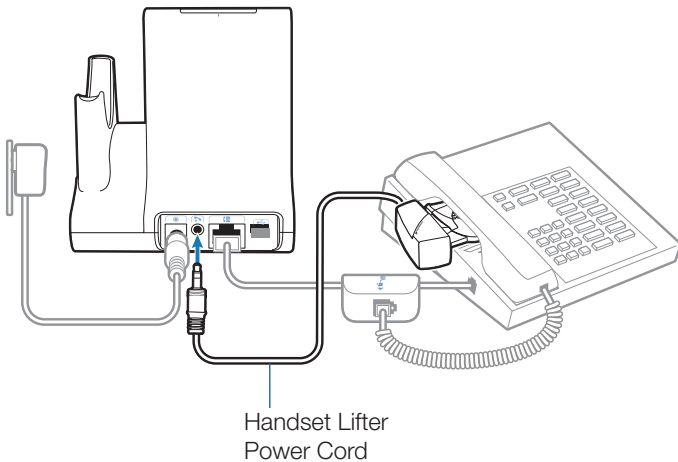

- 1 Firmly press the handset lifter power cord into the handset lifter jack.
- 2 While wearing your headset, slide the handset lifter arm under the handset until the lifter base touches the side of the phone.
- 3 Slide the lifter up to where it nearly touches the handset earpiece.

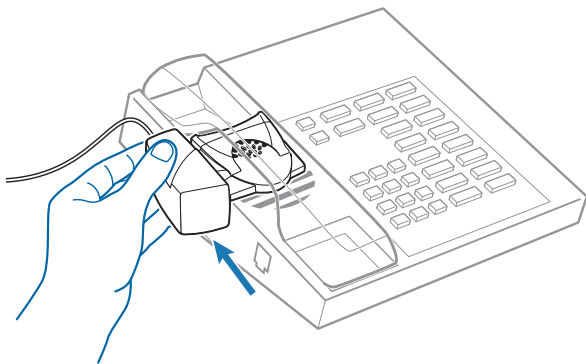

- 4 Press the call control button on your headset to activate the lifter.
- 5 If you hear a dial tone the lifter is set correctly and needs no adjustment.
- 6 Remove the protective strips from the 3 mounting tapes on the underside of the lifter.

- 7 Gently place the lifter on the desk phone in the pre-determined position.
- 8 Press firmly to adhere.

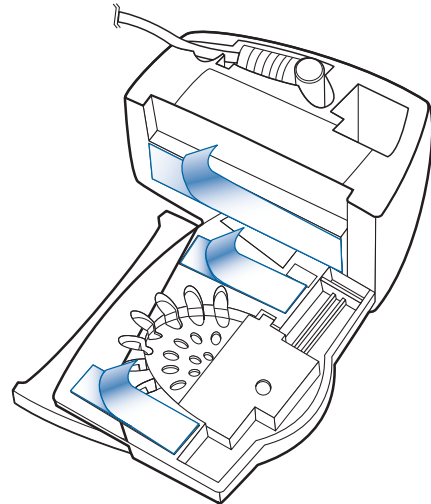

5.2 If You Do Not Hear a Dial Tone

- 1 If you do not hear a dial tone, raise the lifter height switch to the next highest position.

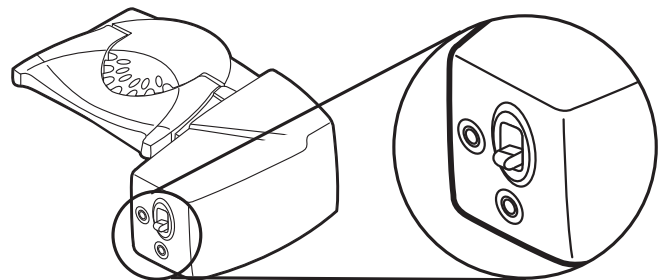

- 2 Repeat steps 2 through 5 in Section 5.1 as necessary until you hear a dial tone.
- 3 When you hear a dial tone, secure the lifter as described in steps 6 through 8.

5.3 Additional Parts (If Required)

Extender Arm

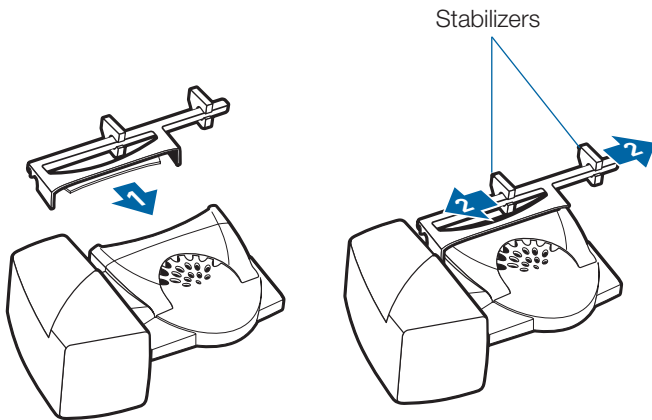

Use extender arm when the handset lifter needs additional stability lifting and returning handset to cradle.

- 1 Slide extender arm onto lifter.**
- 2 Stabilizers can be shifted left and right.** Position stabilizers on outsides of handset to gently grip the phone.

Ringer Microphone

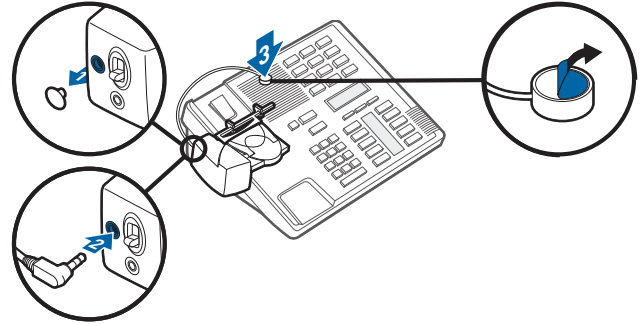

Use ringer microphone only when the telephone speaker is not located directly under the handset.

- 1 Remove cover from ringer microphone jack on back of lifter.**
- 2 Connect ringer microphone plug.**
- 3 Place ringer microphone over phone speaker.** Remove adhesive tape and attach.

For Nortel i2004 Phones Only

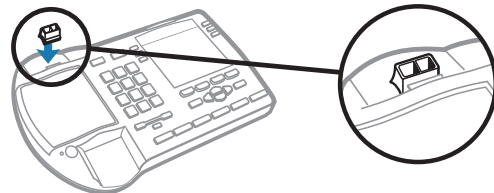

6 PC Set Up

6.1 Installing USB Cable

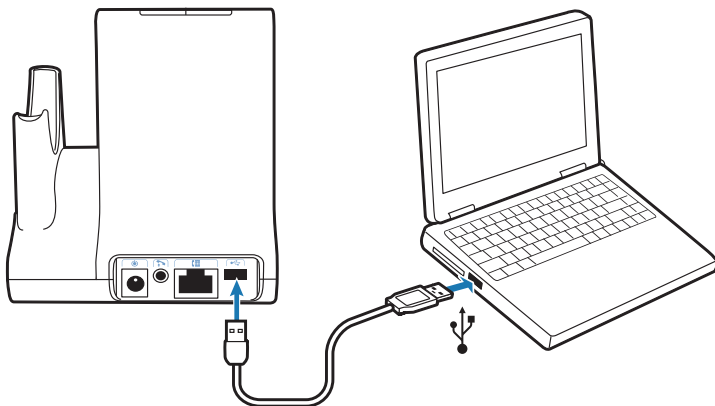

- 1 Connect the **USB** cable to the **USB** port on the back of the base.
- 2 Connect the other end of the **USB** cable to the **USB** port of the **PC**.

6.2 Installing Plantronics Software

- 1 In the animated setup guide located on the CD, select [Step 6.2 Installing Plantronics Software](#).
- 2 Click on the graphic of the CD labeled “Plantronics Software”.
- 3 Follow installation instructions shown on screen.

6.3 Making a Test Call with PC

- 1 While wearing your headset, press the **PC talk button** on the base.
- 2 Dial the number using your softphone application.
- 3 Adjust listening and speaking volume over the PC as follows:

For **Windows® XP Systems-**

Go to the “**Voice**” tab of the “**Sounds and Audio Devices**” option in your **PC** control Panel.

- “**Voice playback**” volume is your receive volume
- “**Voice recording**” volume is your transmit volume

For **Windows Vista® Systems-**

Go to the “**Playback**” tab for listening volume or “**Recording**” tab for speaking volume of the “**Sound**” option in your **PC** control panel.

- “**Speakers Level**” volume is your receive volume
- “**Microphone Level**” volume is your transmit volume

- 4 You can fine tune the listening volume on the headset by pressing the **[+]** to increase the volume and the **[-]** to decrease the volume.

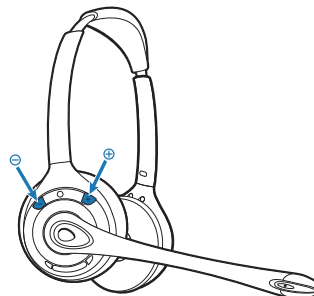

- 5 To end the test call, press the **call control button** on the headset.

7 Using Your Savi Office Wireless Headset System

IMPORTANT It is highly recommended that you install the Plantronics software. Though your Savi Office system will operate without the software it will limit the system's full capabilities.

Powering Up Headset

If the headset battery is charged the headset is automatically on. The headset does not have an on/off button.

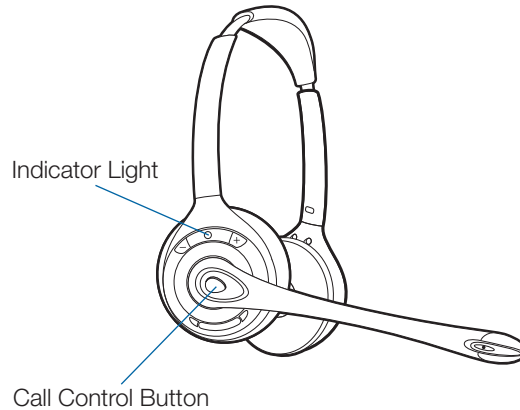

Placing, Answering, and Ending Calls with Desk Phone

	Phones with Handset Lifter or Electronic Hookswitch	Phones without Handset Lifter or Electronic Hookswitch
To place a call	<ol style="list-style-type: none"> 1. Short press call control button on headset* or short press base desk phone talk button 2. Dial number 	<ol style="list-style-type: none"> 1. Short press call control button on headset* or short press base desk phone talk button 2. Remove handset from cradle** 3. Dial number
To answer a call	<ol style="list-style-type: none"> 1. Short press call control button on headset or short press base desk phone talk button 	<ol style="list-style-type: none"> 1. Short press call control button on headset or short press base desk phone talk button 2. Remove handset from cradle**
To end a call	<ol style="list-style-type: none"> 1. Short press call control button on headset or short press base desk phone talk button 	<ol style="list-style-type: none"> 1. Short press call control button on headset or short press base desk phone talk button 2. Return handset to cradle**

* Assumes your default line is set to desk phone.

** To place, answer, and end calls with desk phones that have a headset button and without a handset lifter, you will need to press the headset button on the desk phone instead of removing the handset from the cradle.

Placing, Answering, and Ending Calls with PC

	With Plantronics Software*	Without Plantronics Software
To place a call	1. Dial number from the supported softphone application***	1. Short press call control button on headset** or short press base PC talk button 2. Dial number from softphone application
To answer a call	1. Short press call control button on headset or short press base PC talk button	1. Short press call control button on headset** or short press base PC talk button 2. Answer call using softphone application
To end a call	1. Short press call control button on headset or short press base PC talk button	1. Short press call control button on headset** or short press base PC talk button 2. Hang up call using softphone application

*Assumes use of supported softphone

**Assumes your default line is set to PC

*** Automatically bringing up the PC radio link is not supported when placing an outbound call in Microsoft Office Communicator.

Switching Between Desk Phone and PC Audio

You can switch back and forth between desk phone and PC audio the following ways:

Headset

Press the volume up button (at least 1½ seconds) until the base talk button indicator light of the desired device becomes solid green.

Base

Short press (less than one second) the base talk button of the device that you want to switch to.

Mixing Desk Phone and PC Audio

You can mix desk phone and PC audio the following way:

Base

Simultaneously hold the desk phone and PC talk buttons down (at least 1½ seconds) until both indicator lights become solid green.

Muting the Headset

You can mute/unmute the headset the following ways:

Headset	Base
Short press the dedicated mute button to toggle mute on/off.	Short press (less than one second) of a red desk phone or PC talk button on the base will unmute the headset. You cannot mute the headset using the desk phone or PC talk buttons.

Subscribing a Master Headset

The headset and base are subscribed to each other at the factory. In the event that you need to subscribe a new master headset to the base you can do so one of two ways. You can subscribe a master headset to the base with the headset docked (secure subscription) or undocked (over-the-air subscription). In either case, the system must be idle (not on a call).

Headset Docked	Headset Undocked
Double press the subscription button on the base. The subscription light will flash red and green. When the subscription light becomes solid green, the headset and base are subscribed to one another.	Double press the subscription button on the base. The subscription light will flash red and green. Press the volume up button on the headset for three seconds until the headset indicator light turns solid green. When the subscription light on the base becomes solid green, the headset and base are subscribed to one another.

NOTE If the subscription process times out after two minutes or if the subscription process fails, the subscription light will become solid red for four seconds and then return to its previous state. If this occurs, try to re-subscribe the headset again.

Conferencing In Up to Three Additional Headsets

While on a call you can subscribe up to three additional headsets to your base for conferencing. As you add headsets to the base an additional headset icon will appear in the Plantronics software screen with a number from 1 to 3 indicating the number of additional headset subscribed to the base.

Guests may conference in as described below:

1 While you are on a call:

a) Place the guest's headset into primary user's charge cradle.

OR

b) Place the guest's headset into over-the-air subscription mode by pushing the headset volume up button for three seconds until the indicator light becomes solid green.

2 Short press (less than one second) the subscription button on the base.

The subscription light will flash yellow and green.

3 The subscription light will then turn solid yellow and you will hear a tone in the master headset indicating a guest wishes to join the call.

4 If you press the call control button on the master headset within five seconds, the guest is joined to the call.

If you do not press the call control button within five seconds, the request to join the call is rejected and the guest will hear an error tone in their headset.

5 Guests may leave the conference call by pressing their call control button.

When they do you will hear a single tone in the master headset as each guest leaves the call.

To see how many headsets are subscribed to the base, refer to the lower left corner of the Plantronics software screen. The first headset is the master headset and the number inside the next headset is the number of guest headsets subscribed to the base. The examples below show 1, then 2, then 3, guest headsets subscribed to the base in addition to the master headset.



Setting Default Line to Desk Phone or PC

The Savi Office system ships with the desk phone as the default outbound line. This means any call initiated from the headset with the call control button will open desk phone audio. You can change your default outbound line from the base talk buttons.

While the system is in idle mode, press and hold the PC talk button or the desk phone talk button for three seconds to select that device as your default outbound line. The talk button indicator light will flash green for four seconds confirming the new setting.

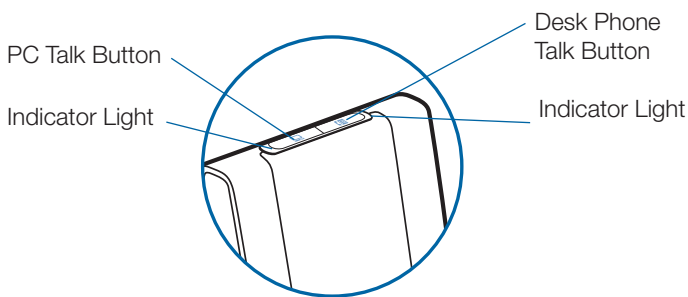

Toggle On/Off Over-the-Air Subscription

The Savi Office system ships with the over-the-air subscription enabled. You can toggle on or off over-the-air subscription using the subscription button on the base. With the master headset **UNDOCKED** and the system idle, press the subscription button for three seconds. The subscription button will flash green for four seconds if over-the-air subscription is on and red for four seconds if off.

Setting the Range

With the master headset **DOCKED** and the system idle, press the subscription button for three seconds. Both the desk phone and the PC talk buttons will flash green for high range. If you press the subscription button again for three seconds, the talk buttons will flash yellow for medium range. If you press the subscription button again for three seconds, the talk buttons will flash red for low range.

Ending Subscription

If the base is in subscription mode (secure or over-the-air), and you want to end the base from searching for a headset, press the subscription button again. The subscription light will turn solid red for four seconds and then go to its previous state.

Subscription Button Indicator Light

Master headset subscribed to base	Solid green
Base in master subscribing mode	Flashes red and green
Base conferencing in additional guest headset(s)	Flashes yellow and green
Active conference call with guest headsets subscribed to base	Solid yellow

Desk Phone and PC Talk Buttons Indicator Lights

No active audio link	Off
Incoming call	Flashes green
Active audio link	Solid green
Master headset muted	Solid red
Call on-hold	Flashes red
Seeking Audio Link*	Solid yellow

*When bringing up a link from the base, the talk button will be solid yellow until a link is established. This could take up to several seconds especially for wideband audio and/or when in moderate to high density environments. If you press the talk button when the indicator light is yellow, it will terminate the search for an audio link.

Desk Phone and PC Talk Buttons “Rules to Live By”

Button (Indicator Light) State	If Button Is Pressed
Off	Solid green
Flashing green	Solid green
Solid green	Off
Solid red	Solid green
Flashing red	Solid green

NOTE If in any state, you hold down both the PC and desk phone talk buttons for 1½ seconds both indicator lights will turn solid green and the audio from both devices will be mixed.

Talk Time

The Savi Office system will provide up to 8 hours of talk time. Talk time will be reduced when operating in wideband mode and/or if the headset is used consistently at a far distance from the base.

Checking Headset Battery Level

When the system is idle, short press the Base subscribe button once to get feedback on the headset battery level.

Headset Battery Level	Base PC LED	Base Deskphone LED
75–100%	Solid green	Solid green
50–75%	Flashes green	Flashes green
25–50%	Flashes yellow	Flashes yellow
0–25%	Flashes red	Flashes red

Headset Call Control Button Functions

Type of Press	Function
Short press	Places, answers, or ends calls
Short press volume up	Increases volume
Short press volume down	Decreases volume
While in a link, long press volume up (at least 1½ seconds)	Switches between desk phone and PC audio
Short press mute button	Mutes or unmutes headset
While not in a link, long press volume up (at least 1½ seconds)	Places headset in subscription mode
While not in a link, long press volume down (at least 1½ seconds)	Enables and disables headset in-use indicator light

Placing the Headset in Sleep Mode

If you won't be using the headset for a long duration and the headset will not be in the charge cradle, you can put the headset in sleep mode by pressing the call control button for three seconds while in an idle state. To exit sleep mode, press the headset call control button again for three seconds.

Headset Indicator Light

Headset Status	Headset Indicator Light
Headset charging	Off
Headset fully charged	Off
Headset in-use	Flashes green
Subscribing	Solid green

Toggle On/Off Headset In-Use Indicator Light

If you are not on a call, you can toggle the headset in-use indicator light on and off by pressing the headset volume down button for three seconds.

Headset Tones

Out of Range Warning

If you are on a call and go out of the operating range, you will hear three low tones. You will hear a single mid tone when you are back in range.

If you stay out of range, active calls will be suspended. Calls will be re-established upon walking back into range. If you remain out of range for more than 5 minutes the system will drop the call.

If you are not on a call and go out of the operating range and press the call control button, you will hear a single tone for the button press and three low tones for the failure to make a link.

Low Battery Warning

If you are on a call, you will hear a repeating single low tone every 15 seconds indicating the battery is low. You should recharge the headset immediately.

If you are not on a call and press the call control button, you will hear three low tones indicating the battery is low. You should recharge the headset immediately.

Mute Warning

When mute is activated, you will hear three high tones. These tones will repeat every 15 seconds while mute is active.

When unmuted you will hear three low tones.

8 Plantronics Software Platform

Softphone Support

Download Plantronics software for remote call answer/end with supported softphones at plantronics.com/software.

Remote call answer/end from the Savi headset is available for all softphones with no additional steps by the user except Skype™. For a list of supported softphones visit plantronics.com/software.

For Skype support, please follow these steps:

- 1 Skype will display the following message during the install of Plantronics Unified Runtime Engine “PlantronicsURE.exe wants to use Skype”. Choose “Allow Access” to connect.
- 2 You can also check Savi Office system Skype connection status by going to Skype and checking the Tools>Options>Advanced>Advanced Settings>”Manage Other Programs Access” setting.

Plantronics Update Manager

All required software for Savi Office system can be remotely updated when updates are available. Start Plantronics Update Manager from Windows Start Programs menu to change settings such as automatic or manual check for updates.

Check for Updates Automatically: By enabling this check box, you will activate a periodic automatic check for available software updates.

Check for Updates Now: You can choose to check for available software updates at any time by clicking on the Check For Updates Now button in Update Manager: From the Start menu, click Programs, then Plantronics, then open Plantronics Update Manager.

Install Checked Updates: Following an **AUTOMATIC** or **MANUAL CHECK FOR UPDATES**, this field will be populated with any applicable software updates and the **INSTALL CHECKED UPDATES** will begin installation.

Plantronics Control Panel

User preferences and various device settings can be changed using the Plantronics Control Panel. To start this program, click Start>Programs>Plantronics then open Plantronics Control Panel.

Battery Life

At the lower left corner of the screen (and for all software screens), you will see one of the following icons indicating the approximate charge left in the headset battery.



Devices Tab

To configure your settings, select Savi Office from the pull down menu and click the Device Settings button. Below are the setting options and defaults for the base and headset.

NOTE Some parameters that do not apply to a particular Plantronics device may appear grayed out.

Device Settings – Base

	Feature	Settings	Default
General	Default Line	Deskphone/PC	Deskphone
	Range	High/Med/Low	High
	Auto Answer	Selected/Not selected	Not selected
	Over-the-Air Subscription	Selected/Not selected	Selected
Audio	Deskphone Audio Bandwidth	Wideband/Narrowband	Narrowband
	PC Audio Bandwidth*	Wideband/Narrowband	Narrowband
	Deskphone Tone Control	Variable Bass to Treble	Midrange
	PC Tone Control	Variable Bass to Treble	Midrange
Feature Set Lock	(See Device Settings - Security)		

*The system will support both narrowband and wideband audio from the PC. Wideband audio delivers heightened speech clarity and life-like fidelity. However, wideband audio consumes more battery power and has more stringent access criteria which reduces the number of systems that can be deployed in a small area.

All PCs support wideband audio.

When switching between narrowband and wideband audio, you must re-establish the audio link for the changes to take effect.

Device Settings – Headset

	Feature	Settings	Default
General	Mute Tone	Standard/Low/Off	Standard
	Deskphone Ringtone	Sound 1/Sound 2/Sound 3	Sound 1
	Deskphone Volume	Standard/Low/Off	Standard
	PC Ringtone	Sound 1/Sound 2/Sound 3	Sound 2
	PC Volume	Standard/Low/Off	Standard
	System Tones	Standard/Low/Off	Standard
	Second Inbound Call	Ring Continuously/Ring Once/Ignore	Ring Continuously

Device Settings – Advanced

	Feature	Settings	Default
Audio Protection	Audio Limiting	80 dB/85 dB/off	Off
	Hours on phone per day	2/4/6/8	8
	Anti-Startle	Selected/Not selected	Not selected
	G616	Selected/Not selected	Not selected
Feature Set Lock	(See Device Settings - Security)		

Device Settings – Security

The Plantronics software allows some of the device parameters settings to be locked by the IT staff and prevent end users from changing them. The ability to lock/unlock these parameter settings requires the creation of a password. In order to lock/unlock any parameter setting follow these steps:

Feature Set Lock

- 1 From the Security screen, create and confirm your new password and press Set.** This will store the password directly in the device.
- 2 In order to lock/unlock some parameter, go to the Base or the Advanced tabs of Device Settings and enter the password that you stored in the device.**
- 3 Select your settings from the Base/Advanced settings page and lock/unlock each feature as desired.**

Change Password

- 1 You can always change the old password to a new one in the Change Password section.** If a password is not stored in the device, the only way to store a password in the device is to use Feature Set Lock. You will only able to change a password if there is a previous password set in the device.

NOTE In case you forget your password, you will need to call your local Plantronics Technical Support for assistance.

Applications Tab

The Applications Tab displays the status of Plantronics support for various applications such as softphones and media players. The status will only show as “enabled and running” for softphones and media players installed and running.

Preferences Tab

The Preferences Tab allows you to set preferences for the media player as well as other general settings.

	Feature	Settings	Default
Media Player	Action to Media Player – When a call begins – When a call ends	Mute/pause/do nothing Unmute/play/do nothing	Pause Play
General	Launch audio devices control panel	(Provides a shortcut to the Windows Sounds and Audio Devices control panel.)	
	Default Softphone	(Displays the default softphone.)	
	Ring Both Headset and PC	Selected/Not selected	Selected
	Microsoft Office Communicator Dial-tone Enabled	Selected/Not selected	Not selected
	Audio Sensing Enabled	Selected/Not selected	Not selected
	Maintain Headset to PC Link	Selected/Not selected	Not selected

Ring Both Headset and PC

This parameter gives you the option to have the PC ringtone played on both the headset as well as the PC speaker.

When this parameter is selected, the PC ringtone will be heard on both the PC speaker as well as the headset.

When this parameter is not selected, the PC ringtone will only be heard on either the headset or the PC speaker based on how the PC audio has been set up.

Microsoft Office Communicator Certified product:
Default Setting = Not selected

Standard product: Default Setting = Selected

Microsoft Office Communicator Dial-tone Enabled

If this feature is selected, when a PC radio link is established, Microsoft Office Communicator will assume the user is trying to place a VoIP call and provide a dial tone.

If this feature is not selected, when a PC radio link is established, Microsoft Office Communicator will sit idle.

“Microsoft Office Communicator Dial-tone Enabled” can be set selected or not selected.

Microsoft Office Communicator Certified product:
Default Setting = Selected

Standard product: Default Setting = Not selected

Audio Sensing Enabled

Audio Sensing is a special feature supported by Plantronics wireless devices that can detect an audio signal at the USB port and automatically establish a PC radio link between the Base

and wireless headset without the user having to press the PC call control button. If the parameter “Microsoft Office Communicator Dial-tone Enabled” is selected, then every time a PC radio link is established the Microsoft Office Communicator dial tone will be heard. However, the user may have pressed the PC call control button to listen to music, etc., and does not want to hear the dial-tone. In this case, if the user selects the “Audio Sensing Enabled” parameter, the radio link will be established automatically when any PC audio is detected at the USB port, thus eliminating the need for the user to press the PC call control button.

“Audio Sensing Enabled” can be set to selected or not selected.

Microsoft Office Communicator Certified product:
Default Setting = Selected

Standard product: Default Setting = Not selected

Maintain Headset to PC Link

This parameter forces the radio link to the PC to stay active even after the call has ended. This can eliminate the need to re-establish the radio link when switching between PC audio applications.

Default Setting = Not selected

About Tab

The About Tab provides on-line access to this printable user guide and also includes Plantronics contact information. The current version of software and firmware currently running on your system is also shown here.

Help for Device Settings - Base

Default
Settings

Range*	<p>Range can be minimized to help with PC buzzing, improve user density, or restrict range of users.</p> <p>When Range is set to HIGH a user will have up to 300 feet of range.</p> <p>When Range is set to MEDIUM a user will have up to 150 feet of range.</p> <p>When Range is set to LOW a user will have up to 50 feet of range.</p>	High
Auto Answer	<p>Auto answer saves the user a button press to establish the radio link between headset and adapter.</p> <p>When auto answer is set to OFF you must press the headset call control button to answer an incoming call.**</p> <p>When Auto Answer is set to ON an incoming call will be answered when the headset is removed from the charge cradle.**</p>	Not Selected
PC Audio Bandwidth*	<p>The system will support both narrowband and wideband audio from the PC.</p> <p>Wideband audio delivers heightened speech clarity and life-like fidelity. However, wideband audio consumes more battery power and has more stringent access criteria which reduces the number of systems that can be deployed in a small area.</p> <p>All PCs support wideband audio.</p> <p>When switching between narrowband and wideband audio, you must re-establish the audio link for the changes to take effect.</p>	Narrowband

* When bringing up a link from the base, the talk button will be solid yellow until a link is established. This could take up to several seconds especially for wideband audio and/or when in moderate to high density environments. If you press the talk button when the indicator light is yellow, it will terminate the search for an audio link.

**Assumes use of a lifter or EHS cable with desk phone and/or use of a softphone that is supported by Plantronics software.

Help for Device Settings - Advanced

Anti-Startle	<p>Anti-startle provides advanced hearing protection against sudden loud sounds. When Anti-startle is set to ON, the system identifies and eliminates sudden loud sounds and rapidly reduces them to a comfortable level. When Anti-startle is set to OFF, the headset caps sound levels at 118 dBA to protect your hearing.</p>	Off
G616*	<p>G616 Acoustic Limiting provides additional hearing protection against acoustic shock. When G616 Acoustic Limiting is set to ON, the system provides additional acoustic shock protection. Sound levels are limited to 102 dBA as recommended in the G616:2006 guideline issued by the Australian Communications Industry Forum (ACIF). When G616 Audio-Limiting is set to OFF, the headset caps sound levels at 118 dBA to protect your hearing.</p>	Off
Audio Limiting*	<p>Audio Limiting provides advanced hearing protection for daily noise exposure. When Audio-Limiting is turned ON, the system monitors and controls sound to ensure action levels do not exceed 80 dBA or 85 dBA (whichever is selected) specified by current and imminent EU legislation. When Audio-Limiting is set to OFF, the headset caps sound levels at 118 dBA to protect your hearing.</p>	Off

*The noise monitoring and G616 limiting features are based on a typical headset and recommended acoustic coupling between the headset and the ear. Please follow the instructions for optimal wearing position on page 8.

9 Troubleshooting and Common Questions

I can't hear a dial tone at the headset.

Make sure your headset is charged.
Make sure your headset is subscribed to base. See [Subscribing a Master Headset](#) on page 15.
Press the call control button on your headset.
Make sure the lifter is lifting the handset high enough to operate the hookswitch; set to a higher setting if necessary.
Adjust the configuration switch on the base until a dial tone is heard.
Fine tune the listening volume with the call control button.
If the volume is still too low, adjust the desk phone listening volume on the base.

I hear static.

Make sure there is at least 12 inches between your base and your computer, and 6 inches between your base and your telephone. If adjusting the distance doesn't help, your headset is going out of range, move closer to the base.

The sound is distorted when using my Savi Office system with my desk phone.

Lower the desk phone speaking volume and/or Desk Phone Listening Volume on the base. For most telephones, the correct setting is position 3.
If your desk phone has a volume control, lower until the distortion disappears.
If the distortion is still present, adjust the headset volume control to lower the headset speaker volume. If the distortion persists, lower the Desk Phone Listening Volume on the base.
Make sure there is 12 inches between your base and your computer, and 6 inches between your base and your telephone.

I hear echo in the headset when using my desk phone.

Adjust the Configuration Switch. The most commonly used position is "A", which is the default position.
Lower the Desk Phone Listening Volume on the base. For most telephones, the correct setting is position 3.
If the audio level is too low in this position, adjust the headset volume control to increase the headset speaker volume.
Lower the Desk Phone Speaking Volume on the base. For most telephones, the correct setting is position 3.
If your speaking volume is too low for your listener in this position, adjust the position of the headset to make sure the microphone is as close as possible to your mouth.

People I talk to can hear a buzz in the background.

Move the base further away from your phone.
Base power supply is plugged into a power strip. Plug the power supply into the wall directly.

Talk time performance is significantly degraded even after a full recharge.

Battery is wearing out. Call Plantronics at (800) 544-4660 for factory service information or contact us at plantronics.com/support.

The handset lifter is installed but does not lift the handset.

Be sure the handset lifter power cord is firmly pushed into the handset lifter jack on the base.

I can no longer hear any audio through my PC Speakers.

For Windows XP Systems:

Refer to the “Audio” tab of the “Sounds and Audio Devices” option in your PC Control Panel.

- Under “Sound playback” change the default setting from Savi Office to your PC speakers. Click “OK” to confirm your change.

For Windows Vista Systems:

Refer to the “Sound” option in your PC Control Panel.

- Under the “Playback” tab change the default setting from “Speakers Savi Office” to your PC speakers. Click “OK” to confirm your change.

No audio connection to PC.

Unplug USB and power cables from base. Reconnect power cable first. Wait for power LED to illuminate, then re-connect USB cable. Quit and then re-start your PC audio or softphone application.



Plantronics, Inc.
345 Encinal Street
Santa Cruz, CA 95060
United States
Tel: 800-544-4660
plantronics.com
For product support contact us at plantronics.com/support.

© 2010 Plantronics, Inc. All rights reserved. Plantronics, the logo design, HL10, Savi, and Sound Innovation are trademarks or registered trademarks of Plantronics, Inc. Windows is a registered trademark of Microsoft Corporation. Nortel is a trademark of Nortel Networks. Skype is a registered trademark of Skype Limited. All other trademarks are property of their respective owners.

Patents: U.S. 7,633,963; D599,331; D582,901; D602,008; D538,785; D505,413; D535,285; China ZL200830005437.x; ZL200830005446.9; ZL200630123313.2; ZL200630123314.7; EM 000873823-0004; 000873823-0003; 000543798-0004; 000543798-0005; Taiwan D127496; D127400; D117515; D117333

84159-01 (06.10)