

Vista™
Universal Modular Amplifier
M12

345 Encinal Street
Santa Cruz
CA 95060
Tel 1.800.544.4660
www.plantronics.com

User's Guide



Printed in USA
© 1998 Plantronics, Inc.



43346-01 (9+98)

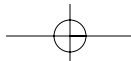

welcome

to the Vista™ Universal Modular Amplifier from Plantronics®.

The Vista Universal Modular Amplifier adapts your telephone to a Plantronics headset and provides control of the sound through your headset. The Vista amplifier has built-in sound conditioning and protection.

This User Guide will help you install your Vista amplifier and learn its basic operations.

The Vista amplifier is not designed to work on telephones that have the dial pad in the handset or on cordless telephones.

PART I Install in 4 easy Steps

- Step 1: Install batteries.
- Step 2: Attach to phone and headset.
- Step 3: Set default settings.
- Step 4: Set telephone/amplifier compatibility switch.

PART II Make a test call.

PART III Learn the basics.

Vista™ Universal Modular Amplifier

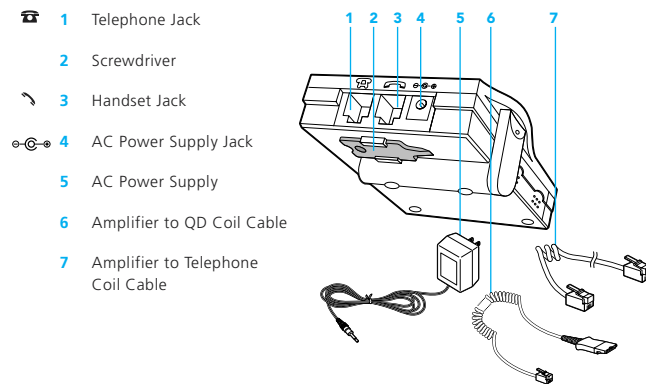
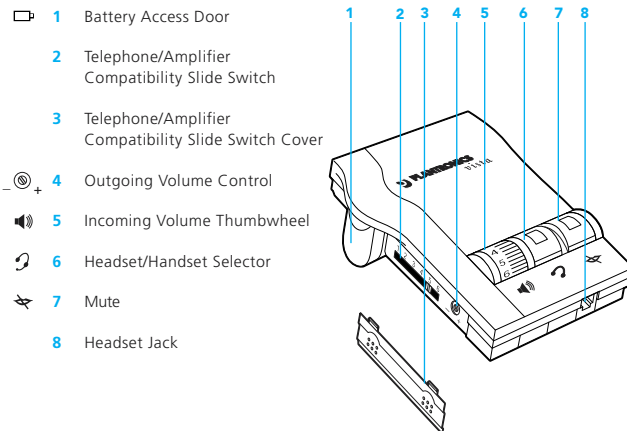

connections

& features

Connect the Vista amplifier to your telephone as shown. Follow the four easy steps on the following pages for complete installation details.

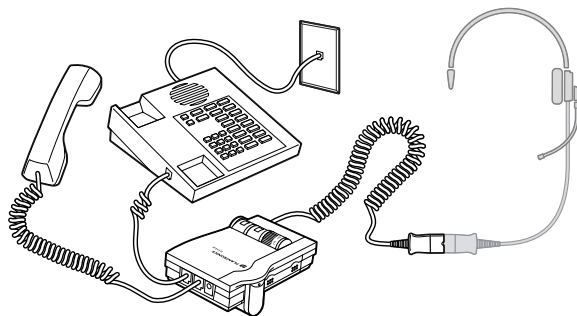

Amplifier Features

- SoundGuard® Plus™ Sound Compression protects you from harsh noises, such as fax tones
- Call Clarity™ System improves incoming and outgoing sound
- Switch easily between headset and handset
- Incoming and outgoing volume control
- Mute

PART

install
in 4 easy steps

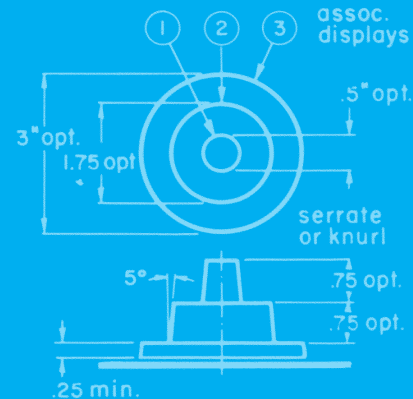

INSTALL BATTERIES

ATTACH TO PHONE AND HEADSET

SET DEFAULT SETTINGS

SET TELEPHONE/AMPLIFIER COMPATIBILITY SWITCH

INSTALLATION STEPS

STEP 1 install
batteries

The Vista Amplifier requires power to work with most phones.

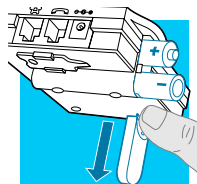

1. Remove the Battery Access Door located on the side of the amplifier by placing your thumb on the door and pushing down.
2. Install two AA alkaline batteries and replace the door.
3. You will hear three "beeps" through the headset when the batteries are low.

INSTALLATION STEPS

STEP 2 attach to
phone and headset

1. Unplug your telephone's handset cord from the telephone base.

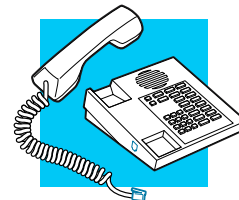

2. Plug your telephone's handset cord into the Vista amplifier handset jack (↘).

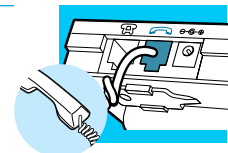

3. Connect your telephone base to the Vista amplifier telephone jack (↗) using the short curly cord. On your telephone base, plug the short curly cord into the outlet normally used for your handset.

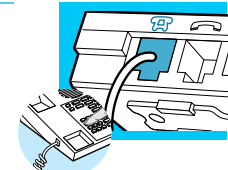

4. Plug the headset cord into the Quick Disconnect™ (QD) module on the long curly cord coming from the front of the amplifier. The QD will allow you to disconnect the headset from the amplifier when you are not using the phone, or need to move away from the amplifier, while leaving your headset in place.

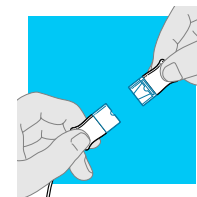

INSTALLATION STEPS

STEP 3 set default settings

These are the default settings for headset use.

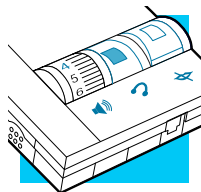

1. Headset/Handset Selector is depressed (colored indicator showing).
2. Mute Switch is released (no colored indicator showing).
3. Incoming Volume Thumbwheel is set to 4.

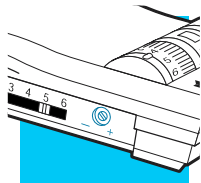

4. The Outgoing volume has been pre-set. You can adjust it when you place your first call (see page 6).

INSTALLATION STEPS

STEP 4 set telephone/amplifier Compatibility Switch

1. Put on headset.
2. Lift the phone's handset off the cradle and place it on your desk.
3. If you don't hear a dial tone, adjust the Telephone/Amplifier Compatibility Switch as indicated below:

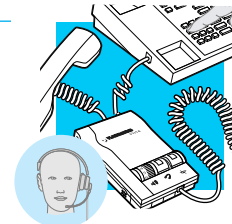

1. Remove the Telephone Compatibility Switch Access Door by placing two fingers or thumbs on the raised bumps and pushing down.

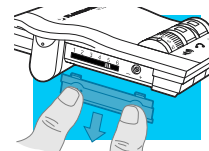

2. Remove the flat, plastic screwdriver from the bottom of the amplifier by sliding it through the braces holding it in place.
3. Make sure the amplifier is in the default settings, and your telephone handset is off of its cradle.

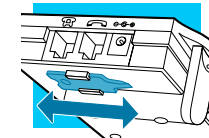

4. Using the screwdriver, slide the Compatibility Switch until you hear a clear dial tone. Experimenting with various switch settings will not harm the amplifier or your telephone.

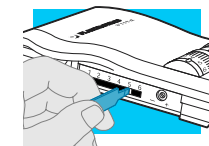

PART

III

make a test call

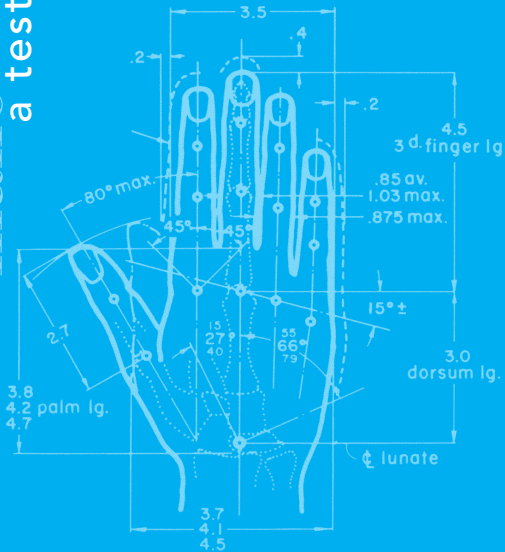

MAKE A TEST CALL.

1. Put on headset. Refer to your headset's User Guide to adjust the microphone position for best performance.
2. Lift the phone's handset off the cradle and place it on your desk.
3. Make sure your Vista amplifier settings are in default. See page 4 for details.
4. Call a friend or colleague.
5. Adjust the Incoming Volume using the Incoming Volume Thumbwheel. Refer to page 10 for more details.
6. Adjust the Outgoing Volume Control until the person on the other end can hear your voice at an appropriate level. See page 10 for more details.
7. If your friend cannot hear you, or you hear a buzz or hum, try changing the Compatibility Switch. See page 5 for more details.
8. Try activating the Mute function by depressing the Mute Switch (colored indicator showing). Release the Mute Switch (no colored indicator showing) to deactivate the Mute function. See page 11 for more details.
9. If you used batteries in your Vista amplifier, try removing the batteries. If you lose power, your phone model requires power for your Vista amplifier. Replace the batteries.

PART

learn the basics

10 oz. min.
40 oz. max.

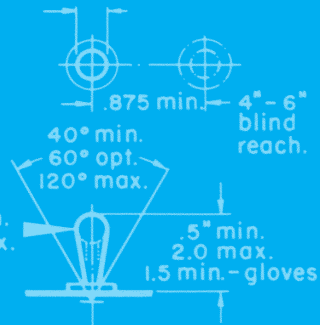

DEFAULT SETTINGS

MAKING AND RECEIVING CALLS WITH A HEADSET

ADJUSTING • HEADSET INCOMING VOLUME
• HEADSET OUTGOING VOLUME

MUTING A CALL

MAKING AND RECEIVING CALLS WITH A HANDSET

LEARN THE BASICS.

Default settings

These are the default settings for headset use:

1. Headset/Handset Selector is depressed (colored indicator showing).
2. Mute Switch is released (no colored indicator showing).
3. Incoming Volume Thumbwheel is set to 4.

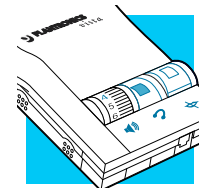

Making and Receiving Calls with a Headset

1. Put on headset.
2. Make sure the amplifier settings are in default.
3. Lift the phone handset off the cradle and place on your desk.
4. Make or receive your call. You will use the dial pad and/or other features of your telephone as you would normally.
5. To end the call, hang up the handset.

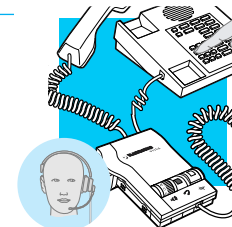

LEARN THE BASICS

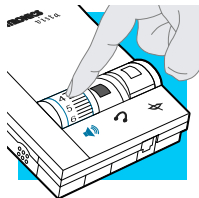
**Adjusting Headset Incoming Volume**

1. Adjust the volume by turning the Thumbwheel on the top panel.
2. Try different volume settings. 1 is the quietest and 9 is the loudest.
3. "Make a Test Call" (see page 7) provides more details about adjusting your incoming volume.

Adjusting Headset Outgoing Volume

1. Outgoing Volume is pre-set. Try making a test call before adjusting (see page 7).
2. To access the Outgoing Volume Control, remove the panel on the left-hand side of the amplifier. The same panel houses the Telephone/Amplifier Compatibility Switch.
3. Use the screwdriver attached to the bottom of the amplifier to adjust the Outgoing Volume Control. Turn clockwise to make your voice louder to the caller. Turn counter-clockwise to make your voice quieter to the caller.
4. Replace the panel door and the screwdriver.

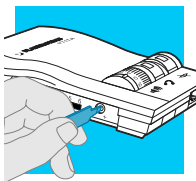
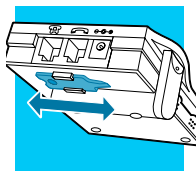

LEARN THE BASICS

Muting a Call

1. Activate the Mute function by depressing the Mute switch (colored indicator showing).
2. Deactivate the Mute function by releasing the Mute switch (no colored indicator showing).

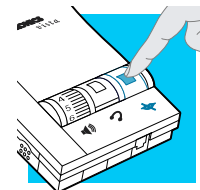
**Making and Receiving Calls with a Handset**

1. Release the Headset/Handset switch (no colored indicator showing).
2. Use the phone handset as you normally would.

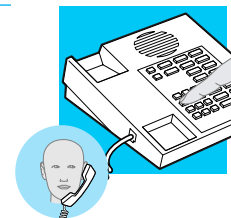
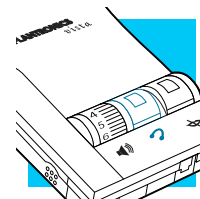

A maintenance and troubleshooting

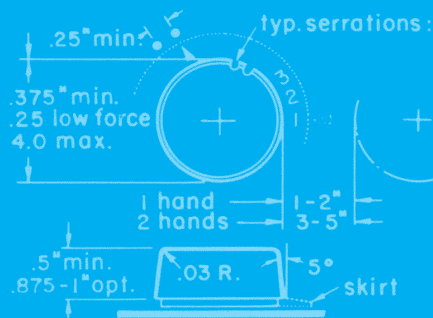

MAINTENANCE AND TROUBLESHOOTING

Maintenance Hints

Trouble Shooting Guide

PROBLEM	ITEMS TO CHECK
I DO NOT HEAR A DIAL TONE WHEN I TRY TO MAKE OR RECEIVE A PHONE CALL.	<p>If you are using batteries, confirm that they are good and placed in the battery compartment correctly.</p> <p>If you are using an AC Power Supply, confirm that it is plugged in and the power outlet is turned on.</p> <p>Confirm that the Headset/Handset Selector switch is depressed (colored indicator showing).</p> <p>Confirm that you have lifted the telephone handset out of the cradle.</p> <p>Confirm that the telephone handset cable and the short curly pigtail to the telephone are connected to the correct jacks. (see "Installation")</p> <p>Confirm that the Telephone/Amplifier Compatibility Switch is in the correct setting for your phone (see "Set the Telephone/Amplifier Compatibility Switch" on page 5). You may want to try moving the switch through all of the positions until you hear a clear dial tone. Experimenting with various switch settings will not harm the amplifier or your phone.</p> <p>The Plantronics Help Desk is ready to assist you! Monday through Friday 8:00 AM to 5:00 PM PST 800 544-4660</p>

Maintenance Hints**Trouble Shooting Guide**

PROBLEM	ITEMS TO CHECK
MY CALLERS SAY THAT THEY CAN'T HEAR ME AT ALL OR THEY CAN'T HEAR ME VERY WELL.	<p>Make sure the microphone of your headset is positioned in front or near your mouth. If you are using a "noise-cancelling" headset, the position of the microphone is very important. You may need to adjust the "Outgoing Volume". See "Adjusting Headset Outgoing Volume" on page 10).</p> <p>Confirm that the Telephone/Amplifier Compatibility Switch is in the correct setting for your phone (see "Set the Telephone/Amplifier Compatibility Switch" on page 5). You may want to try moving the switch through all of the positions until your caller hears you clearly. Experimenting with various switch settings will not harm the amplifier or your telephone.</p>
I GET A LOW PITCHED HUM IN MY HEADSET SPEAKER AND/OR MY CALLERS COMPLAIN THEY CAN HEAR HUM.	<p>Try moving the Telephone/Amplifier Compatibility Switch through all of the positions until the hum disappears. Experimenting with various switch settings will not harm the amplifier or your telephone.</p>
I HEAR THREE 'BEEPS' IN THE HEADSET.	<p>If you are using batteries to power the Vista Amplifier, the three 'beeps' tell you that the batteries are low and need to be replaced. See "Install Batteries" on page 2.</p>

SECTION B

parts and accessories

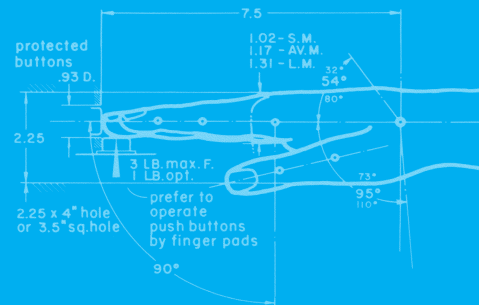

REPLACEMENT PARTS AND ACCESSORIES FOR VISTA

For information on accessories and spare parts, call Plantronics at 1-800-544-4660, or visit the Plantronics web site at www.plantronics.com

AC Power Supply

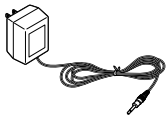

ITEM	PART #
AC Power Supply	26503-01

Telephone/Amplifier Compatibility Slide Switch Door

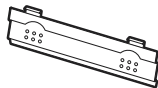

ITEM	PART #
Telephone/Amplifier Compatibility Slide Switch Door	44015-01

Battery Door



ITEM	PART #
Battery Door	44014-01

Amplifier to Telephone Coil Cable

(male to male modular plugs)

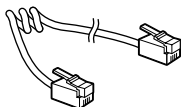

ITEM	PART #
Amplifier to Telephone Coil Cable	40974-01

Amplifier to QD Coil Cable

(QD to male modular plug)

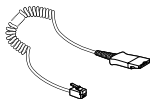

ITEM	PART #
Amplifier to QD Coil Cable	26716-01

REPLACEMENT PARTS AND ACCESSORIES FOR VISTA

Velcro® Amplifier Attachment Kit

ITEM	PART #
Velcro Amplifier Attachment Kit	17521-01

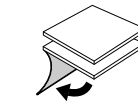

Amplifier Security Device

(attaches amplifier to desk.)

ITEM	PART #
Amplifier Security Device	40696-01

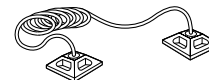

Plantronics Custom Cradle Mate

(holds handset "off-hook" and a flashing "BUSY" light indicates when headset is in use)

ITEM	PART #
Plantronics Custom Cradle Mate	40715-01

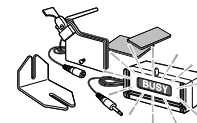

Cradle Mate only

(easy-to-use device that mechanically holds handset "off-hook")

ITEM	PART #
Cradle Mate only	40714-01

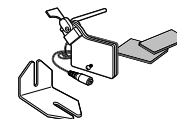

WARRANTY AND SERVICE

WARRANTY AND SERVICE

The following warranty and service information applies only to the U.S. and Canada. For information in other countries, please contact your local distributor.

To obtain in or out of warranty service, please prepay shipment and return the unit to the appropriate facility listed below:

IN THE UNITED STATES

Plantronics Service Center
345 Encinal Street
Santa Cruz, CA 95060
Tel. (800) 544-4660
(831) 458-7700
Fax (800) 279-0162

IN CANADA

Plantronics Service Center
1455 Pitfield Blvd.
Saint-Laurent, Quebec H4S 1G3
Tel. (800) 540-8363
(514) 956-8363
Fax (514) 956-1825

Please use the original container, or pack the unit(s) in a sturdy carton with sufficient packing material to prevent damage. **Include the following information:**

1. A proof-of-purchase indicating model number and date of purchase.
2. Bill-to address
3. Ship-to address
4. Number and description of units shipped
5. Name and telephone number of person to call, should contact be necessary
6. Reason for return and description of the problem

Damage occurring during shipment is deemed the responsibility of the carrier, and claims should be made directly with the carrier.

The name Plantronics, the Plantronics logo and SoundGuard are registered trademarks of Plantronics, Inc. Vista, Quick Disconnect, Call Clarity and SoundGuard Plus are trademarks of Plantronics, Inc. Velcro is a registered trademark of Velcro USA.

WARRANTY AND SERVICE

FCC REGISTRATION INFORMATION

This equipment complies with Part 68 of the FCC rules. On the bottom of the modular adapter is a label that contains, among other information, the FCC registration number and ringer equivalence number (REN) for this equipment. If requested, this information must be provided to the telephone company.

The telephone company may make changes in its facilities, equipment, operation or procedures that could affect the operation of the equipment. If this happens, the telephone company should provide you advance notice in order for you to make the necessary modifications to maintain uninterrupted services.

If you experience problems with your headset, please refer to the warranty section for information on warranty and repair service. If the problem is causing harm to the telephone network, the telephone company may request that you remove the equipment until the problem is resolved. In extreme cases, the telephone company may be forced to disconnect your service before notifying you of the problem.