

Jabra®

Jabra PRO™ 9460

Jabra PRO™ 9460 Duo

Jabra PRO™ 9465 Duo

Jabra PRO™ 9470

User Manual

www.jabra.com

WELCOME

Congratulations on purchasing your new Jabra PRO product. We are sure you will enjoy its wide range of features, and find the headset comfortable to wear and easy to use.

Jabra PRO base features

- 2.4" color touchscreen.
- Desk phone and softphone (PC) connectivity.
- Bluetooth® mobile phone connectivity (Jabra PRO 9465 Duo and Jabra PRO 9470 only)
- Touchscreen-guided setup for desk phone, softphone (PC) and mobile phone connections.
- Touchscreen call control for all connected phones.
- On-screen caller ID (mobile phones and softphones (PC) only).
- Headset recharge docking cradle.

Jabra PRO headset features

- Wideband audio for exceptional sound quality.
- Touch panel volume and mute controls.
- Intuitive headset multi-function button for easy call handling.
- LED and audio indicators.
- Advanced hearing protection with SafeTone™.
- Up to 150 meters range from headset to base.

Jabra PRO 9460 headset additional features

- Noise-cancelling microphone.
- Ear-hook or headband wearing style (neckband accessory available).

Jabra PRO 9460 Duo and Jabra PRO 9465 Duo headset additional features

- Noise-cancelling microphone.
- Headband wearing style with left and right speakers.

Jabra PRO 9470 headset additional features

- Dual Noise Blackout™ microphones.
- Ear-hook, headband or neckband wearing style.

CONTENTS

- 1. PRODUCT OVERVIEW6**
 - 1.1 Package Contents6
 - 1.2 Headset.....7
 - 1.3 Headset Attachments.....10
 - 1.4 Base.....12
 - 1.5 Preparing the Base.....13
 - 1.6 Optional Accessories.....13
- 2. CONNECTING TO A PHONE USING THE SETUP WIZARD 14**
 - 2.1 Connect to Power14
 - 2.2 Start the Setup Wizard.....14
- 3. CONNECTING TO A PHONE MANUALLY 15**
 - 3.1 Connect to Power15
 - 3.2 Dock Headset.....15
 - 3.3 Connect to Softphone (PC).....16
 - 3.4 Connect to Mobile phone with *Bluetooth*[®]16
 - 3.5 Select and Connect to a Desk Phone17
- 4. JABRA PC SUITE 19**
 - 4.1 Install Jabra PC Suite.....19
 - 4.2 PC Call Manager19
- 5. JABRA PRO HEADSET FEATURES 20**
 - 5.1 Headset Multi-function Button.....20
 - 5.2 Headset Touch Panel20
 - 5.3 Headset LED Indicator21
 - 5.4 Headset Audio Indicators.....22
- 6. TOUCHSCREEN INTRODUCTION..... 23**
 - 6.1 Touchscreen Overview23
 - 6.2 Change Settings using the Touchscreen.....24

7. BASIC CALL MANAGEMENT	28
7.1 Making a Call or Ending a Call	28
7.2 Accepting or Rejecting an Incoming Call	28
7.3 Adjust Headset Speaker Volume.....	29
7.4 Adjust Headset Microphone Level	29
7.5 Putting a Call on Hold/Audio Hold.....	30
8. ADVANCED CALL MANAGEMENT	31
8.1 Merging Calls	31
8.2 Conference Call with Multiple Headsets.....	32
8.3 Switching Call(s) between Handset and Headset.....	32
8.4 Last Number Redial	32
8.5 Call Disconnect Prevention (Unsupported Softphones)	33
8.6 Recording Desk Phone and Mobile Phone Calls	33
9. ADVANCED JABRA PRO FEATURES	34
9.1 Safetone™ Hearing Protection.....	34
9.2 Wireless Range	34
9.3 Wideband Audio.....	34
9.4 Voice Announcements	35
9.5 Tone Settings	35
9.6 Listening to Music or Audio on PC.....	35
9.7 Firmware Updates.....	35
9.8 Theft Protection.....	35
10. FAQs AND TROUBLESHOOTING.....	36
11. TECHNICAL SPECIFICATIONS	38
11.1 All Jabra PRO Headsets.....	38
11.2 Jabra PRO 9470 Headset.....	38
11.3 Jabra PRO 9460 Headset.....	39
11.4 Jabra PRO 9460 Duo and Jabra PRO 9465 Duo Headsets.....	39

11.5 Jabra PRO Headset Battery39

11.6 Jabra PRO Touchscreen Base..... 39

11.7 Jabra PRO 9465 Duo and Jabra PRO 9470 Base Bluetooth Support40

11.8 Materials and Allergies40

11.9 Product Disposal.....41

11.10 Certifications and Safety Approvals41

1. PRODUCT OVERVIEW

1.1 PACKAGE CONTENTS



Headset



Headband Attachment



Earhook Attachment
(small, medium and large earbuds)

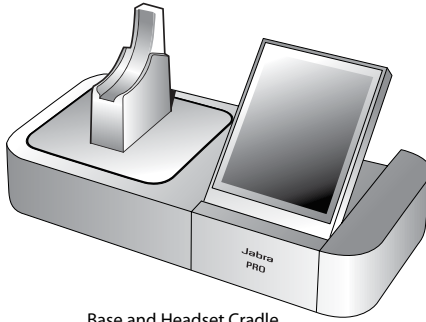

Base and Headset Cradle



Power Adapter



Telephone Cable



USB Cable



Warning & Declaration Booklet



Quick Start Guide



System-optimized Leaflet

1.2 HEADSET

Jabra PRO 9460 headset

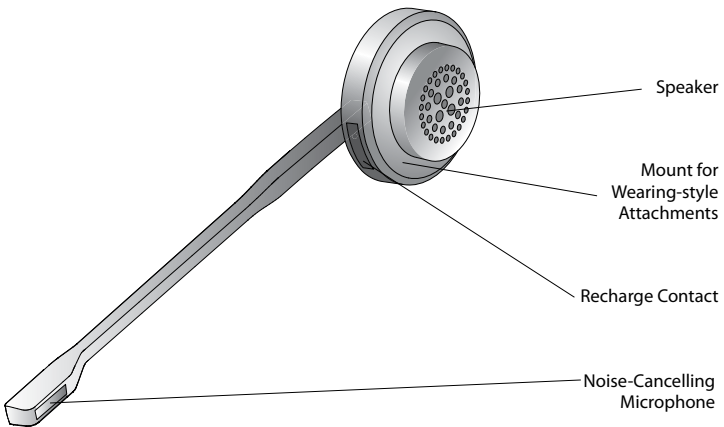
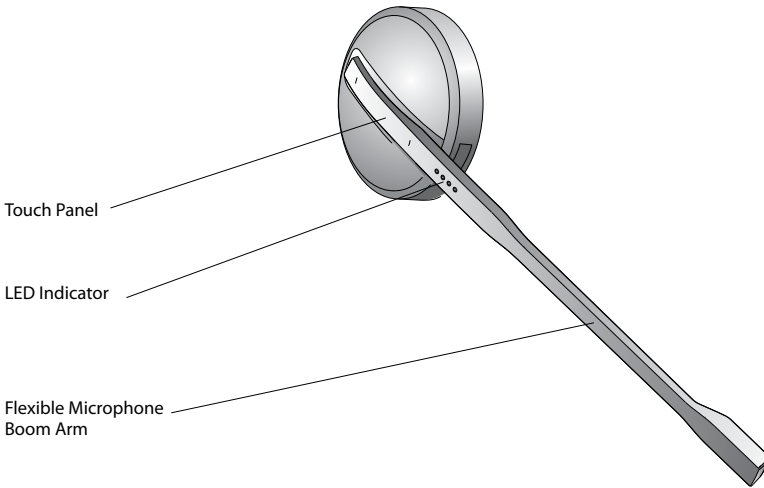
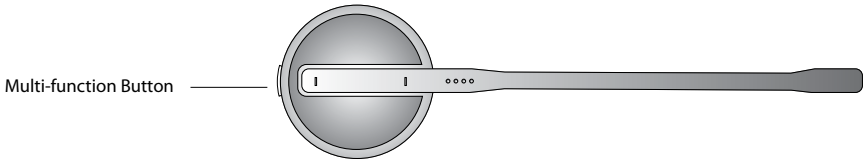

Jabra PRO 9460 Duo and 9465 Duo headset

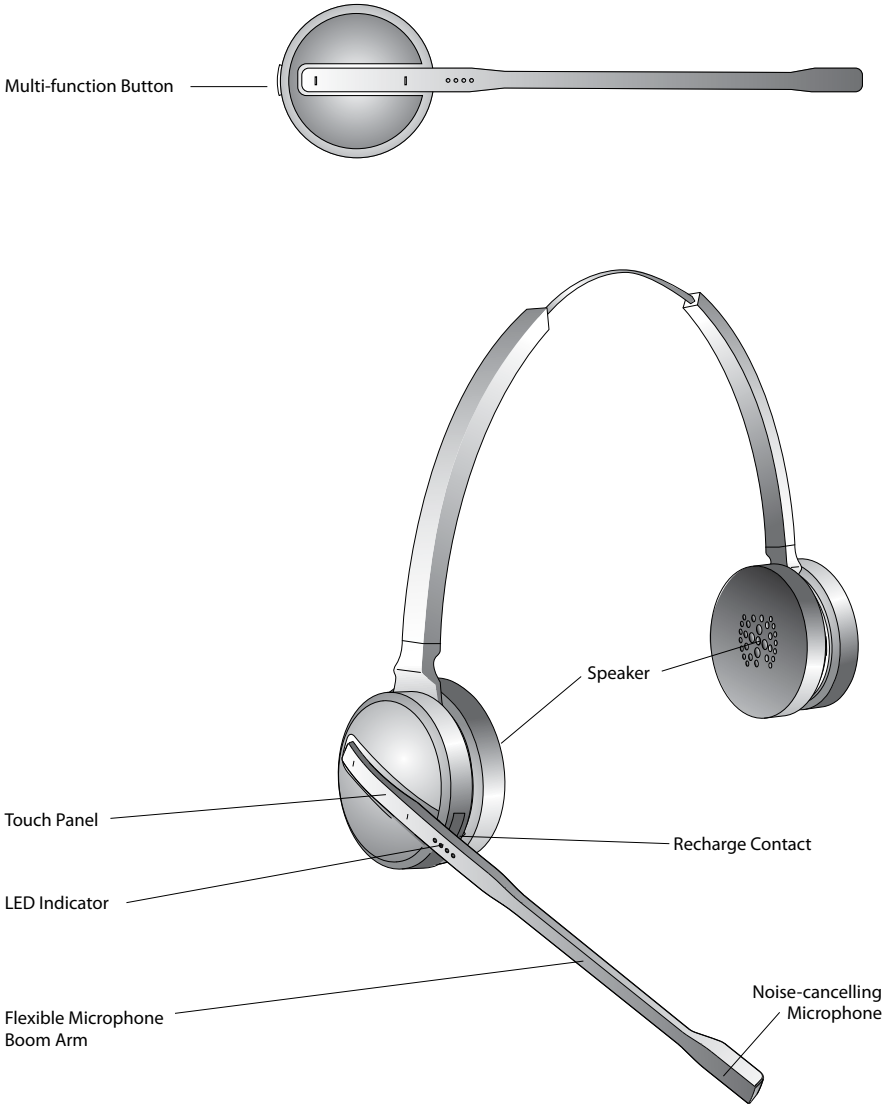

Jabra PRO 9470 headset

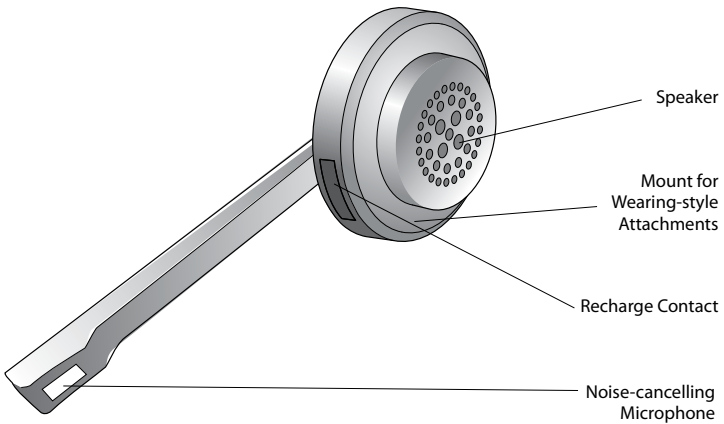
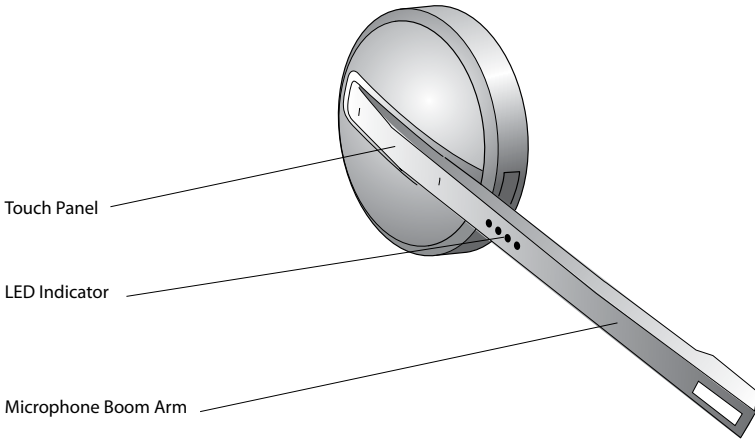
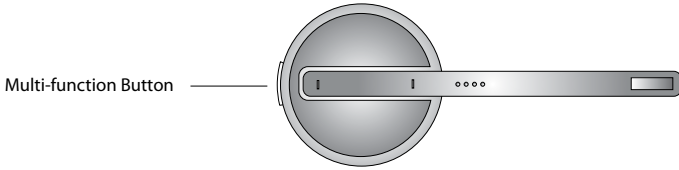

1.3 HEADSET ATTACHMENTS

The Jabra PRO headset can be worn in the headband, earhook or neckband wearing-styles.

Wearing-styles can be worn on the left or right ear, or both if using the Jabra PRO 9460 Duo and 9465 Duo headband. Regardless of wearing style, ensure the microphone is positioned close to the mouth to maximise noise-cancelling and speech quality.

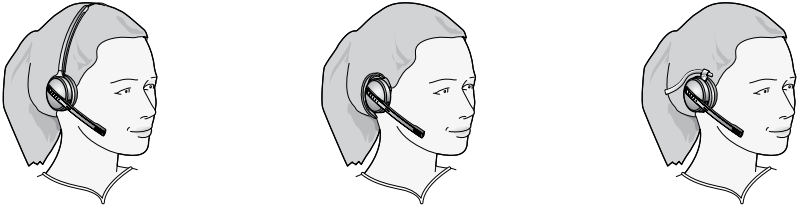

Attaching the Headband

1. Align the headset and the headband wearing-style attachment, as illustrated, and press firmly together until they click into place (snap-to-click).
2. Rotate the microphone boom arm for left or right ear use.
3. Adjust the length of the headband to fit against the head.

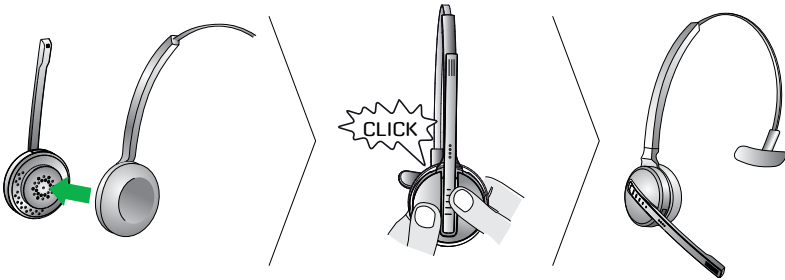

Attaching the Earhook

1. Assemble the earhook wearing-style attachment for left or right ear use. If necessary, remove the earbud and replace with another size for best fit.
2. Align the headset and the earhook wearing-style attachment, as illustrated, and press firmly together until they click into place (snap-to-click).
3. Shape the earhook to fit around the ear.

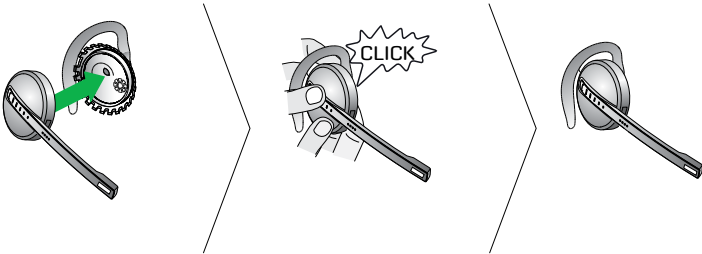

Attaching the Neckband (optional accessory)

1. Decide on left or right ear use, and assemble the neckband attachment, as illustrated.
2. Align the headset and the neckband wearing-style attachment, and press firmly together until they click into place (snap-to-click).

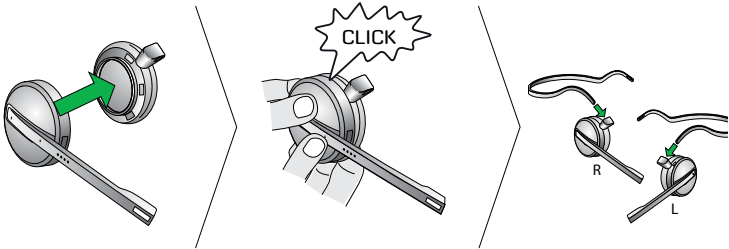

1.4 BASE

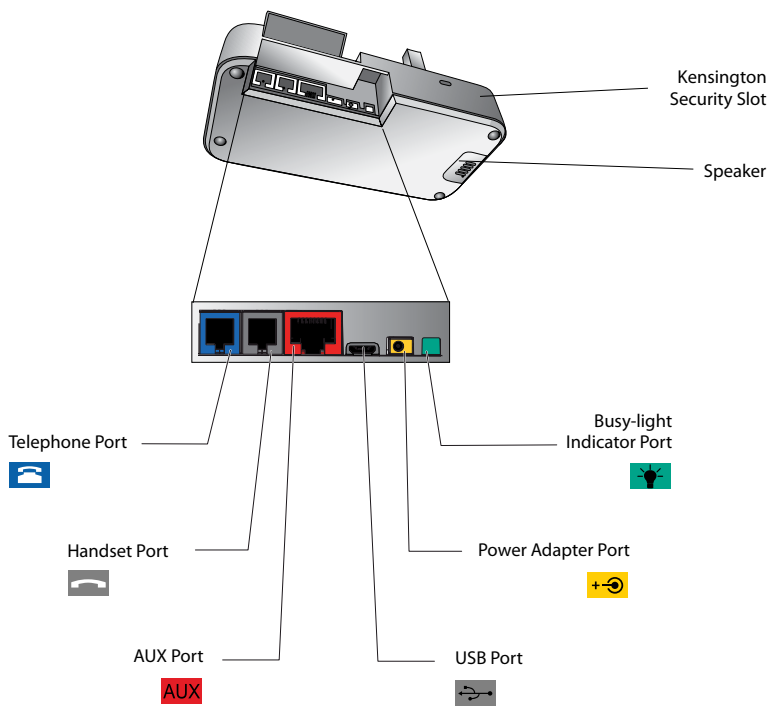
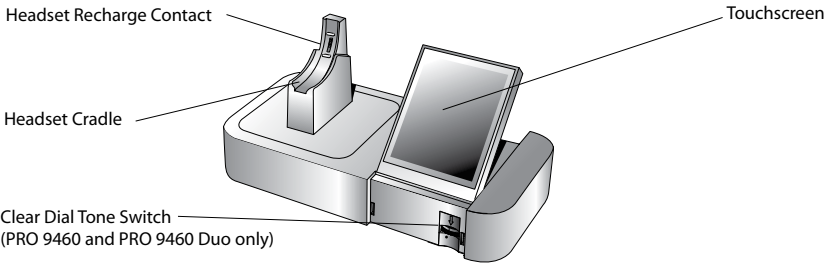

1.5 PREPARING THE BASE

1. Remove the protective foil from the cradle and the touchscreen.
2. Raise the screen to the preferred angle.
3. (Optional) Rotate the cradle for left- or right-handed docking, as illustrated.

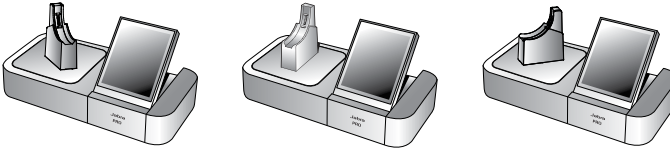

1.6 OPTIONAL ACCESSORIES

The following Jabra PRO accessories are available separately.

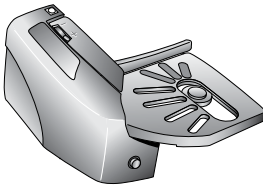

Jabra GN1000

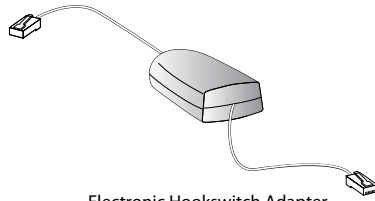

Electronic Hookswitch Adapter
(adapter may vary from illustration)

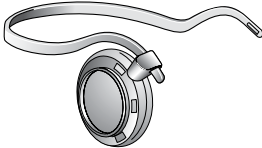

Neckband Attachment



Replacement Headband Attachment

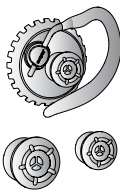

Replacement Earhook, with Earbuds

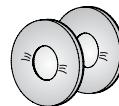

Replacement Ear Cushions

2. CONNECTING TO A PHONE USING THE SETUP WIZARD

The easiest way to connect and configure your Jabra PRO product is to use the setup wizard on the touchscreen. The setup wizard will guide you through connecting and configuring the desk phone, softphone and/or mobile phone.

2.1 CONNECT TO POWER

Connect the power adapter to the base

1. Plug the supplied power adapter into the port marked  on the base.
2. Connect the power adapter to the mains power socket.

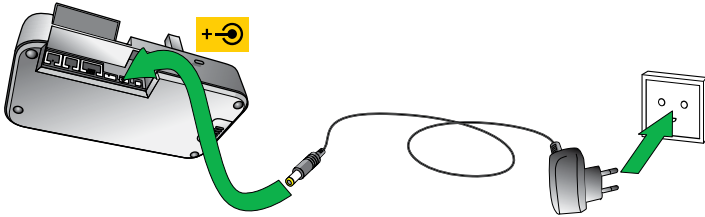

2.2 START THE SETUP WIZARD

The setup wizard automatically starts the first time the base is turned on, however the setup wizard can also be accessed at any time via the touchscreen menu.

1. Tap the tool icon  on the touchscreen to open the settings menu.
2. Tap Phone settings > Setup wizard.
3. Tap Confirm to start the Setup wizard, and then follow the instructions.

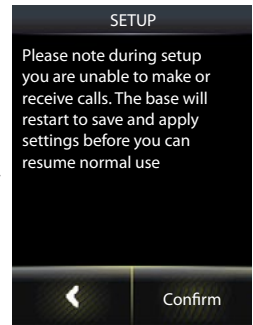
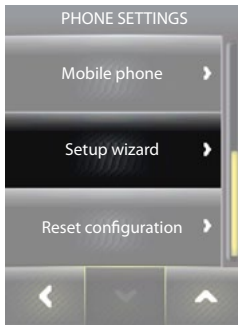

3. CONNECTING TO A PHONE MANUALLY

3.1 CONNECT TO POWER

Connect the power adapter to the base

1. Plug the supplied power adapter into the port marked  on the base.
2. Connect the power adapter to the mains power socket.

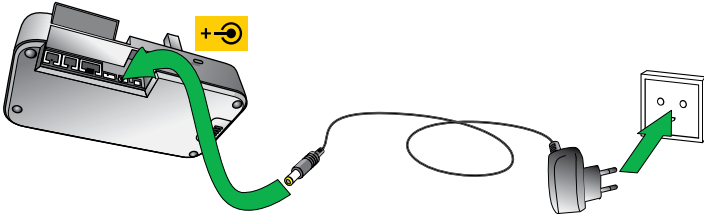

3.2 DOCK HEADSET

Dock the headset, as illustrated. When the headset is docked correctly the docking icon will light up, and the headset battery will begin charging, if needed. Keep the headset docked while connecting the Jabra PRO, or when not in use.

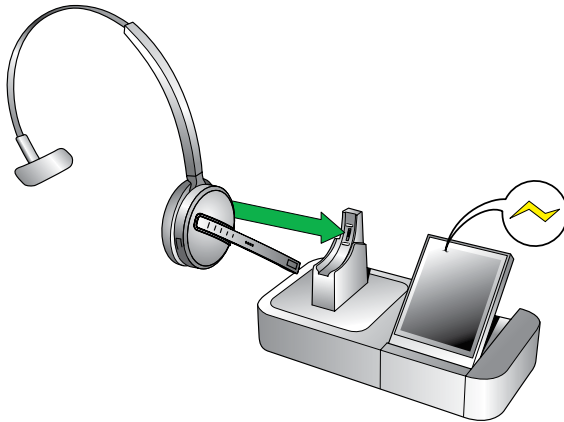



3.3 CONNECT TO SOFTPHONE (PC)

Connecting to a PC will allow connectivity with a PC softphone (such as Skype). Supported softphones have full functionality with the Jabra PRO headset, such as answering and ending calls with the headset multi-function button. Unsupported softphones have only audio functionality with the Jabra PRO headset, and have no interactivity with the Jabra PRO headset call functions.

For the latest list of supported softphones, please visit the Jabra website at www.jabra.com/pcsuite.

Connect the base to a PC, and configure softphone audio

1. Plug the supplied USB cable into the port marked  on the base.
2. Connect the USB cable to any free USB port on the PC.
3. Download and install Jabra PC Suite from www.jabra.com/pcsuite.
4. Tap the tool icon  on the touchscreen to open the settings menu, and tap Phone Settings > Connect Softphone (PC). If your softphone is not supported, select None (audio only) during the setup wizard.
5. Launch softphone software on the PC, and set the Jabra PRO as speaker and microphone in the audio configuration. Refer to specific softphone documentation for assistance in setting audio configurations.

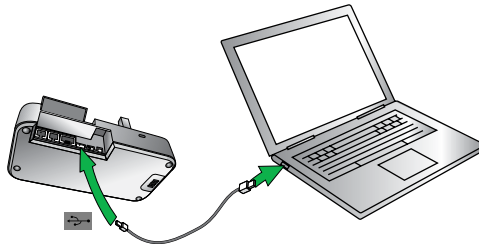

3.4 CONNECT TO MOBILE PHONE WITH *BLUETOOTH*[®]

Connecting to a mobile phone with *Bluetooth* is only available for the Jabra PRO 9465 Duo and Jabra PRO 9470, and is done via the touchscreen.

Connect to a mobile phone using *Bluetooth*[®]

1. Tap the tool icon  on the touchscreen to open the settings menu.
2. Tap Phone settings > Mobile phone > Setup mobile phone.
3. Tap Confirm to start the Mobile phone connection wizard, and follow the instructions.



How to reconnect to mobile phone with *Bluetooth*[®]

If the base loses the *Bluetooth*[®] connection with the mobile phone it will attempt to reconnect for 60 seconds. To force reconnection:

1. Ensure the mobile phone is in range of the base, and that *Bluetooth*[®] is activated on the mobile phone.
2. If there is no connection a *Bluetooth*[®] logo will be displayed on the mobile phone icon on the touchscreen. Tap the greyed out mobile phone icon to begin re-connecting the mobile phone with the base.
3. When successfully reconnected, the mobile phone icon will appear connected.



3.5 SELECT AND CONNECT TO A DESK PHONE

Select which desk phone you are connecting to from the following four options:

OPTION 1

Desk Phone with Headset Port

This type of desk phone has a dedicated headset port (usually at the back of the phone). These phones typically have a button on the front panel for switching between handset and headset.

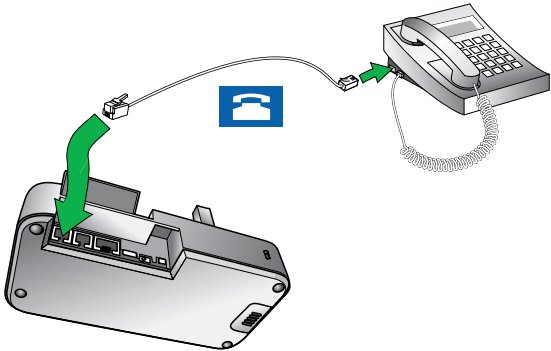

1. Plug the supplied telephone cable into the port marked  on the base.
2. Connect the telephone cable to the headset port  on the desk phone.



OPTION 3

Desk Phone with GN1000 remote Handset Lifter

The GN1000 remote handset lifter manually lifts the desk phone handset to make or answer a call. For mounting instructions refer to documentation supplied with the GN1000.

1. On the desk phone, unplug the handset cable from the phone body.
2. Connect the handset cable to the port marked  on the base.
3. Plug the supplied telephone cable into the port marked  on the base.
4. Connect the telephone cable into the handset port on the desk phone.
5. Connect the GN1000 cable into the port marked  on the base.

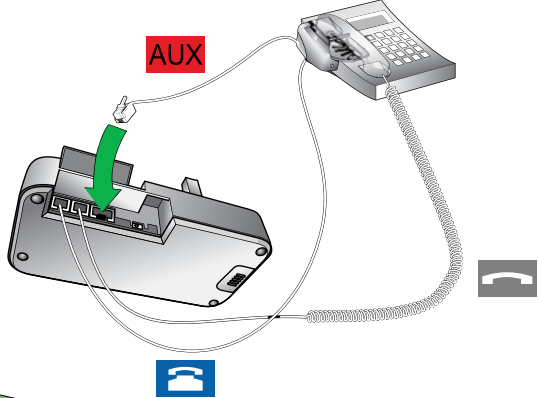

OPTION 2

Desk Phone with Jabra LINK

A Jabra Link adapter enables an incoming call to be answered or ended by the headset multi-function button.

Contact your local Jabra dealer to purchase a Jabra Link adapter for your specific desk phone.

1. Connect the Jabra Link adapter as shown in adapter documentation supplied with the Jabra Link. On some phones the telephone cable will also need to be connected.
2. Call your connected desk phone using another phone to enable the Jabra Link adapter. Wait 10 seconds before answering the phone.

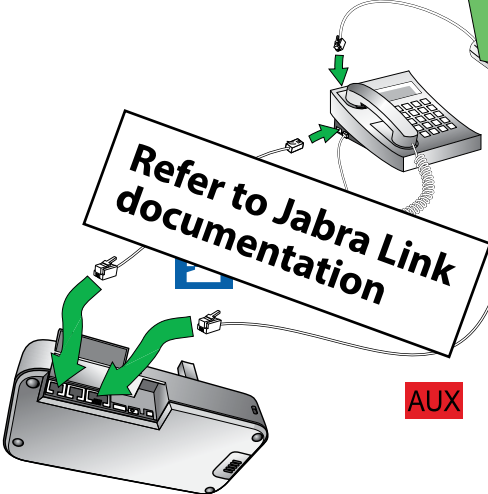

Refer to Jabra Link documentation



OPTION 4

Desk Phone without Headset Port

This desk phone does not have a dedicated headset port.

1. On the desk phone, unplug the handset cable from the phone body.
2. Connect the handset cable to the port marked  on the base.
3. Plug the supplied telephone cable into the port marked  on the base.
4. Connect the telephone cable into the handset port on the desk phone.

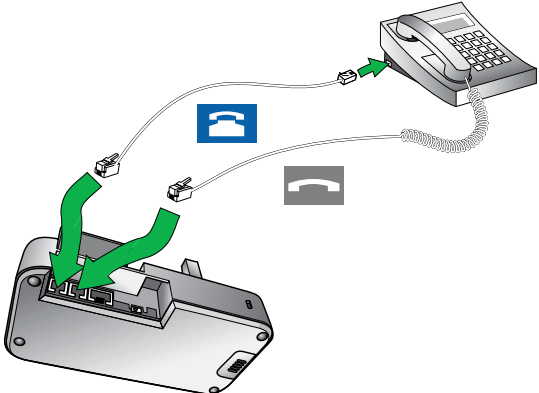

4. JABRA PC SUITE

Jabra PC Suite is a collection of software designed to support the Jabra PRO. For optimal functionality and management of the Jabra PRO, it is highly recommended to install Jabra PC Suite.

Jabra PC Suite consists of:

PC Call Manager

Manages call handling on your PC monitor, and enables call and settings management via PC.

Jabra Control Center

Settings management and monitoring of the Jabra PRO.

Jabra Device Service

Manages the interaction between the Jabra PRO and Jabra Control Center, PC Call Manager, and softphone drivers.

Jabra Firmware Updater

Updates Jabra PRO firmware.

Online Help

Jabra PC Suite help section.

Jabra PC Suite additionally includes drivers for various softphones. For a list of supported softphones, visit www.jabra.com/pcsuite.

4.1 INSTALL JABRA PC SUITE

Download and install Jabra PC Suite from www.jabra.com/pcsuite.

4.2 PC CALL MANAGER

PC Call Manager is PC software that replicates some of the touchscreen call handling functionality on the PC, allowing the user to make calls, answer calls, merge calls etc using their PC. PC Call Manager is installed as part of Jabra PC Suite.

5. JABRA PRO HEADSET FEATURES

5.1 HEADSET MULTI-FUNCTION BUTTON

The headset multi-function button is located on the headset, and can answer calls, end calls, switch between held calls, and more, using a combination of taps, double-taps or presses.

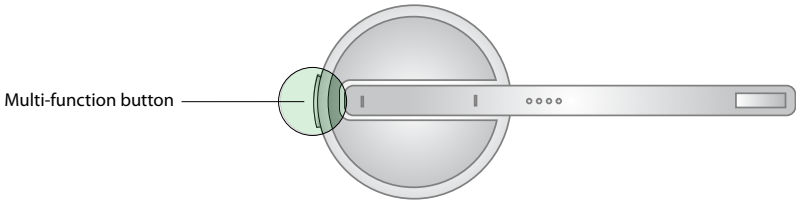

List of headset multi-function button functions

Function	Tap	Double-tap	Press (hold 1-2 seconds)
Answer incoming call	✓		
End current call	✓		
Put current call on hold, and accept incoming call			✓
Open phone line on target phone	✓		
Reject incoming call		✓	
Call last number dialed (mobile phones and supported softphones only)		✓	
Switch between target phone			✓
Power headset on	✓		
Power headset off			✓ (5 secs)

5.2 HEADSET TOUCH PANEL

The touch panel is a touch-sensitive panel located on the top of the microphone arm of the headset, as illustrated. The touch panel controls the headset speaker volume and microphone mute.

Changes made to the speaker volume apply independently to desk phone, softphone or mobile phone.

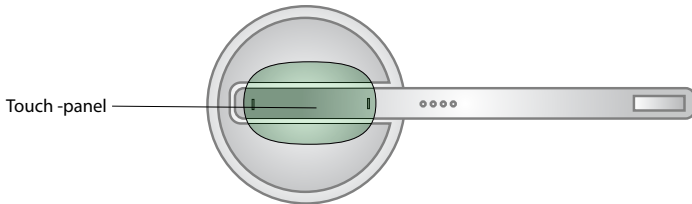

Increase speaker volume	Decrease speaker volume	Mute microphone
Slide finger up the touch panel (away from mouth)	Slide finger down the touch panel (toward the mouth)	Double-tap

5.3 HEADSET LED INDICATOR

The multi-colored LED indicator is a row of four lights located on the arm of the headset, as illustrated, and indicates headset status.

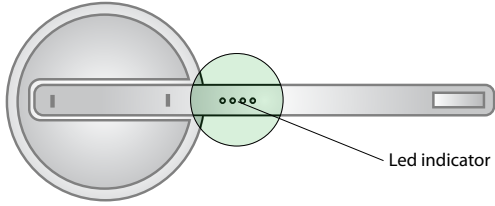

Headset state	LED when battery is full (click to view)	LED when battery is low (click to view)
Idle	▶○○○○	▶○○○○
Not connected	▶○○○○	▶○○○○
Out of range	▶○○○○	▶○○○○
Call active	▶○○○○	▶○○○○
Incoming call	▶○○○○	▶○○○○
Power on	▶○○○○	▶○○○○
Power off	▶○○○○	▶○○○○
Pairing	▶○○○○	▶○○○○
Pairing succeeded	▶○○○○	▶○○○○
Charging	▶○○○○	

5.4 HEADSET AUDIO INDICATORS

The headset plays a variety of audio tones to indicate headset status and actions.

Audio tone	Audio sample (click to listen)	Audio tone	Audio sample (click to listen)
Power on		Target phone changed to desk phone (voice)	
Power off		Target phone changed to desk phone (tone)	
Button tap		Target phone changed to softphone (voice)	
Button double-tap		Target phone changed to softphone (tone)	
Button press		Target phone changed to mobile phone (voice)	
Maximum speaker volume reached		Target phone changed to mobile phone (tone)	
Minimum speaker volume reached		Call ended	
Microphone muted		Battery low	
Incoming call on desk phone		Conference start	
Incoming call on softphone (PC)		Conference end	
Incoming call on mobile phone		Out of range	
Incoming call on different phone while on call (call collision)		Incoming call accepted	

6. TOUCHSCREEN INTRODUCTION

The Jabra PRO touchscreen is a color touchscreen that enables you to connect and configure the Jabra PRO product, manage calls, and manage base, headset and phone settings. Tap the screen with a finger to activate icons, scroll up/down a menu, select a target phone and make/answer/end/merge calls.

NOTE: Touchscreen settings may be locked by an IT administrator. Locked settings will not be available on the touchscreen.

6.1 TOUCHSCREEN OVERVIEW

The touchscreen is divided into three areas: status bar (top), activity window (middle) and call control bar (bottom).



1 Status bar

The status bar is the row of icons at the top of the touchscreen.

Icon	Description
	Indicates the current battery level.
	Indicates the headset is docked.
	Indicates an open audio connection between the base and the headset. If the headset icon has an WB on it, it indicates wideband audio is active.
	Indicates that at least two headsets (primary and secondary headsets) have been paired with the Jabra PRO base, allowing conference calling. The total number of headsets connected will be displayed as a number next to the icon.
	Tap to open the settings menu. The tool icon is only visible when not on a call.
	Tap to open the call options menu. The call options icon is only visible when on a call.

2 Activity window

The activity window is main area of the touchscreen, and displays the currently connected phones, allows phone selection, and also the merging of multiple calls.



Target phone (foreground icon)

The large foreground phone icon indicates the current target phone. To switch target phone tap on the relevant small background phone icon, or press the headset multi-function button when not on a call to cycle through the available phones. The phone icons will change depending on status (e.g. incoming call, outgoing call).

3 Call control bar

The call control bar indicates the options available for the target phone, such as make call, end call, and mute headset.



MSH desk phones have a unique call control bar (see below).



6.2 CHANGE SETTINGS USING THE TOUCHSCREEN

There are a number of settings that can be changed using the settings menu on the touchscreen. The setting menu is accessed by tapping the tool icon  on the touchscreen:

- Base settings
- Headset settings
- Phone settings
- Unpair headset
- About

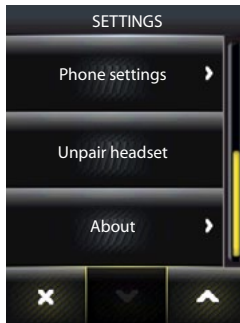
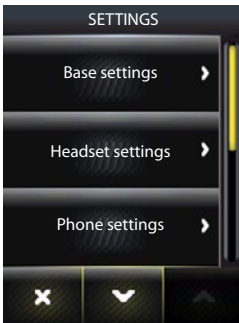

1 BASE SETTINGS

The base settings allow changes to be made to the Jabra PRO touchscreen and base sounds. There are six base settings that can be changed:

Setting	Description
Enable recording	Enable/disable recording of a desk phone or mobile phone call to a PC file
Screen brightness	Adjust the screen brightness
Screen dimmer timeout	Adjust the base idle time before the touchscreen is dimmed
Touchscreen click sounds	Adjust the touchscreen click sounds volume
Language	Set the language for all text on the touchscreen
Wireless range	Select the wireless range between headset and base

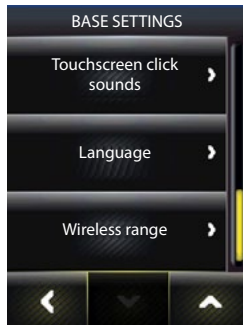
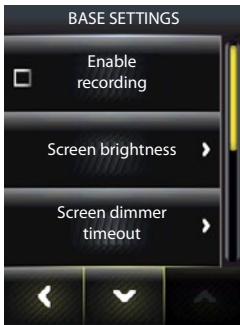

2 HEADSET SETTINGS

The headset settings allow changes to be made to the Jabra PRO headset. There are six headset settings that can be changed.

Setting	Description
Headset intro	A guided tour of how to use the headset functions, such as answer/end calls and volume control
Intellitone	Adjust the intellitone noise protection level
Voice announcements	Select the target phone announcement type
Enable mute reminder tone	Enable/disable the mute reminder tone
Enable touch volume control	Enable/disable touch volume control on the Jabra PRO headset
Enable touch mute control	Enable/disable touch mute control on the Jabra PRO headset

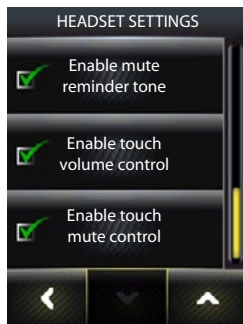
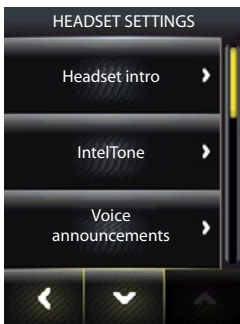

JABRA PRO 9460, JABRA PRO 9460 DUO,
JABRA PRO 9465 DUO AND JABRA PRO 9470

3 PHONE SETTINGS

The headset settings allow changes to be made individually to desk phones, softphones or mobile phone settings, as well as access to the setup wizard and the factory default reset configurations setting.

There are three sub-categories with individual settings specific to the phone type: Desk phone, Softphone (PC) and Mobile phone.

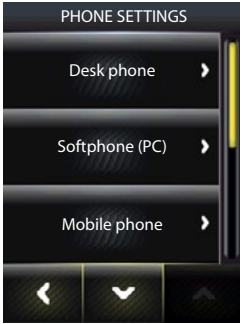

Desk phone settings

Setting	Description
Base ringtone volume	Adjust the desk phone ringtone on the base.
Open phone line on undock	Automatically open the phone line when the headset is undocked.
Enable wideband audio	Enable/disable wideband audio.
Setup desk phone	Start the setup wizard to connect and configure the desk phone.
Disable desk phone	Disable the desk phone connection. The desk phone can be connected again by opening the settings menu, and tapping Phone settings > Desk phone > Enable desk phone.

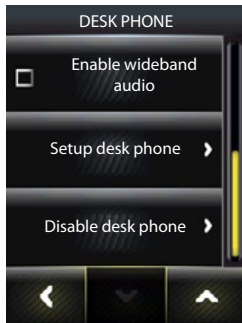
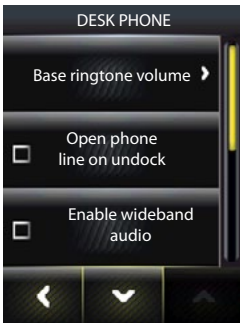

Softphone (PC) settings

Setting	Description
Base ringtone volume	Adjust the desk phone ringtone on the base.
Open phone line on undock	Automatically open the phone line when the headset is undocked.
Enable wideband audio	Enable/disable wideband audio.
Automatic audio detection	Enable/disable automatic audio detection
Setup softphone (PC)	Start the setup wizard to connect and configure the softphone (PC).
Disable softphone (PC)	Disable the softphone (PC) connection. The softphone (PC) can be connected again by opening the settings menu, and tapping Phone settings > softphone (PC) > Enable softphone (PC).

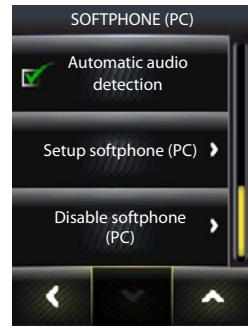
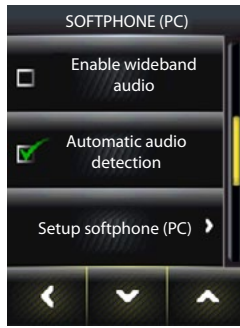
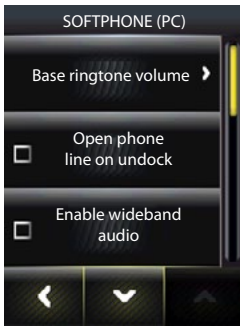

Mobile phone settings

Setting	Description
Base ringtone volume	Adjust the mobile phone ringtone on the base.
Setup mobile phone	Start the setup wizard to connect and configure the mobile phone.
Disable mobile phone	Disable the desk phone connection. The mobile phone can be connected again by opening the settings menu, and tapping Phone settings > Mobile phone > Enable Mobile phone.

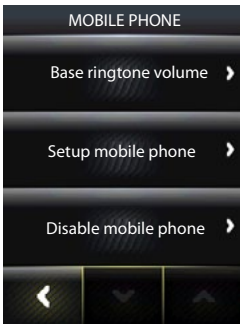

4 UNPAIR HEADSET

Unpairs the primary headset from the base, to allow another headset to be paired to the base as the primary headset.

5 ABOUT

Firmware version and copyright information.

7. BASIC CALL MANAGEMENT

7.1 MAKING A CALL OR ENDING A CALL

1. Ensure the relevant phone type is selected as the target phone (large foreground icon on touchscreen).
If necessary lift the desk phone handset and set aside (desk phone without electronic hookswitch or GN1000 only).
2. Put on the headset, and dial the phone number using the desk phone, softphone or mobile phone.
Alternatively tap the softphone or mobile phone icon on the touchscreen, and select dial pad in the menu to use the touchscreen dial pad.
3. Tap the green handset icon, or tap the headset multi-function button to make the call.
4. To end a call, tap the red handset icon, or tap the headset multi-function button, or dock the headset.

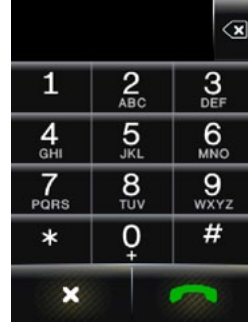

7.2 ACCEPTING OR REJECTING AN INCOMING CALL

Tap the ringing phone icon to answer an incoming call, or tap the headset multi-function button. To reject the call tap the red handset icon.



7.3 ADJUST HEADSET SPEAKER VOLUME

Adjusting the headset speaker volume when on a call can be done using the headset volume touch panel, or by using the touchscreen.

Adjusting the headset speaker volume using the touchscreen

1. When on a call, tap the call options icon  on the touchscreen to open the call options menu.
2. Tap Speaker Volume, and adjust the volume as needed by tapping the + or - icons.
3. When finished, press the back arrow to exit the menu.



7.4 ADJUST HEADSET MICROPHONE LEVEL

Adjusting the headset microphone level when on a call can be done by using the touchscreen.

Adjusting the headset microphone level using the touchscreen

1. When on a call, tap the call options icon  on the touchscreen to open the call options menu.
2. Tap Microphone level, and adjust the level as needed by tapping the + or - icons.
3. When finished, press the back arrow to exit the menu.



7.5 PUTTING A CALL ON HOLD/AUDIO HOLD

To put a current call on hold or audio hold, tap the current call phone icon and tap the pause icon (hold) or the audio hold icon in the touchscreen menu. The phone icon will display the relevant hold symbol to indicate the call is on hold or on audio hold. To resume the call, tap the phone icon again.

Setting	Description
Hold	When hold is enabled the telephone company will stop all audio between the softphone or mobile phone. The listener on the other end of the call can see they have been put on hold.
Audio hold	When audio hold is enabled the Jabra PRO mutes the headset microphone and the headset speaker. The listener on the other end of the call cannot see they have been put on audio hold.

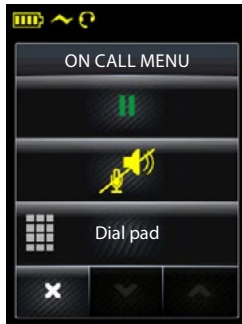

8. ADVANCED CALL MANAGEMENT

8.1 MERGING CALLS

There are two ways to merge calls:

- Merge an outgoing call with a current call.
- Merge an incoming call with a current call.

Merge an outgoing call with a current call

1. Make an outgoing call when on a current call: When on a current call, tap the new relevant phone icon to set that phone as the target phone. The current call will be put on audio hold. Dial the phone number.
2. Merge calls: When the outgoing call has connected, tap the yellow circle icon to merge the calls. When the calls have been merged the circle icon will change to green.



Merge an incoming call with a current call

1. Accept incoming call: While on a call, tap the incoming call's phone icon to accept the incoming call and put the current call on audio hold.
2. Merge calls: When the incoming call has connected, tap the yellow circle icon to merge the calls. When the calls have been merged the circle icon will change to green.



Unmerge call(s)

To unmerge call(s), tap the green circle icon to unmerge the calls. To re-merge the calls press the yellow circle icon again.

End merged call

To end the merged call for all participants, tap the red handset icon on the touchscreen, dock the headset or tap the headset multi-function button.

8.2 CONFERENCE CALL WITH MULTIPLE HEADSETS

The Jabra PRO base enables up to three additional Jabra PRO headsets to be connected for conferencing. When two or more additional headsets are connected to the base, the audio is changed from wideband to narrowband.

Connect additional headset(s)

1. While the primary headset is undocked and on a call, dock a secondary headset with the base hosting the call and then tap the secondary pairing selection on the touchscreen. Pairing will take a few seconds. When the headsets are successfully paired, a double-tone will sound in the primary headset.
2. Tap the headset multi-function button on the primary headset to accept the secondary headset. The audio is now shared between headsets.
3. Repeat the procedure to connect additional headsets, as required.

Ending or leaving the conference

The primary headset user can end the conference by hanging up the call. The call is ended for all headsets. Guests can leave the conference by tapping the headset multi-function button on their headset, or by docking the headset with the base. The conference call is still active for all other headsets.

Permanant conference mode

It is possible to stay in permanant conference mode.

1. Launch Jabra Control Center, and select the 'Headset' tab.
2. Deselect 'End headset conference when call ends'.

8.3 SWITCHING CALL(S) BETWEEN HANDSET AND HEADSET

When on a phone call, it is possible to switch audio between the Jabra PRO headset and a desk phone handset or mobile phone without interrupting the call.

Desk phone

Switch call from desk phone to the headset

1. Lift headset from docking cradle. If necessary, press the headset button on your desk phone. The audio will be transferred from the desk phone to the headset.
2. Do not return desk phone handset to receiver as this will hang up the call.

Switch call from the headset to a desk phone handset (without remote call control)

1. Lift desk phone handset.
2. Dock headset, or tap the headset multi-function button, or tap the desk phone icon on the touchscreen. The audio will be transferred from the headset to the desk phone.

Switch call from the headset to a desk phone handset (with remote call control)

1. Lift desk phone handset.
2. Refer to specific desk phone documentation on how to activate remote call control. In some cases a button must be pressed on the desk phone, while in others it will be automatic.

Mobile phone

Switch call from mobile phone to the headset

1. Tap the headset multi-function button to transfer audio from the mobile phone to the headset.
2. Do not end the call on the mobile phone until the call is finished.

Alternatively audio can be transferred between mobile phone and handset by using the mobile phone's menu. Refer to your mobile phone documentation for further information.

8.4 LAST NUMBER REDIAL

The Jabra PRO can redial the last number dialed (supported softphones and mobile phones only). Check specific softphone or mobile phone documentation for last number redial compatibility.

Last number redial

1. If necessary, press the softphone/mobile phone button on the touchscreen to set softphone/mobile phone as target phone.
2. Double-tap the headset multi-function button to redial the last number called.

8.5 CALL DISCONNECT PREVENTION (UNSUPPORTED SOFTPHONES)

When on a call or in a web conference using an unsupported softphone, any incoming calls on a desk phone or mobile phone will automatically disconnect the softphone call or web conference. To prevent disconnection, tap the softphone icon on the touchscreen to open the softphone sub-menu, and then tap PC Audio Communication before making the call or starting the web conference.

For the latest list of supported softphones, please visit the Jabra website at www.jabra.com/pcsuite.



8.6 RECORDING DESK PHONE AND MOBILE PHONE CALLS

Desk phone and mobile phone calls can be recorded on a PC using third-party software, such as Windows Sound Recorder. To record a desk phone or mobile phone call, call recording must be enabled in the touchscreen settings menu, or in Jabra Control Center.

Enable call recording using the touchscreen

1. Tap the tool icon  on the touchscreen to open the settings menu.
2. Tap Base settings > Enable Recording to enable call recording.
3. When finished, press the back arrow to exit the menu.

Desk phone and mobile phone calls can now be recorded using any third-party software on a PC.

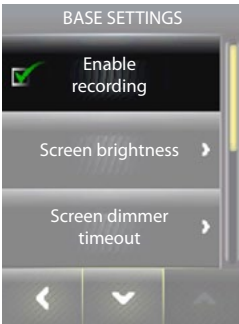

Record current active call (desk phone and mobile phone only)

1. When on a call, tap the call options icon  on the touchscreen to open the call options menu.
2. Tap Enable Recording to enable call recording for the current call.
3. When finished, press the back arrow to exit the menu.

Please note that only the current call will be recorded.

Enable call recording using Jabra Control Center

1. Launch Jabra Control Center, and select the 'Audio' tab.
2. Tick 'Forward desk phone call to PC for recording', and click 'Apply'.

Desk phone calls can now be recorded using any third-party software on a PC.

NOTE: Recording conversations in secrecy may be illegal. Never record conversations without first obtaining permission.

9. ADVANCED JABRA PRO FEATURES

9.1 SAFETONE™ HEARING PROTECTION

SafeTone™ provides effective hearing protection against potential risks, such as acoustic shock and noise exposure. SafeTone™ consists of two components, PeakStop™ and IntelliTone™.

PeakStop™ acoustic shock protection

PeakStop™ automatically suppresses sounds over 118dB(A), protecting hearing from acoustic shock. PeakStop™ is only available from Jabra.

IntelliTone™ noise-exposure protection

IntelliTone™ offers four levels of protection against acoustic shock and noise-exposure. IntelliTone™ settings can be changed via the Jabra Control Center, under the 'Audio' tab. IntelliTone™ is only available from Jabra, or via the touchscreen settings menu > Phone settings > Intellitone.

Protection level	Criteria
Level 0 (default)	Basic protection (over 118dB(A))
Level 1*	Less than 4 hours on phone/day
Level 2*	4-8 hours on phone/day
Level 3*	More than 8 hours on phone/day
Level 4 (TT4)	Recommended Australian protection level (Telstra)

* Compliant with Directive 2003/10/EC of the European Parliament and Council of 6 February 2003.

9.2 WIRELESS RANGE

The Jabra PRO supports a maximum wireless range of up to 150 meters. Physical obstructions and electromagnetic interference may shorten this range.

Headset sound quality may slowly deteriorate the further the headset is away from the base, and may improve the closer the headset is to the base. When the headset is completely out of range, a unique tone (three quick descending notes) will be played in the headset every few seconds.

If the headset is on a call when moved out of range, the audio will be lost; however the call will remain active at the base for 120 seconds. To restore audio to the call, move the headset back in range of the base.

If the headset remains out of range of the base for more than an hour, the headset will power down to conserve battery.

Change wireless range using the touchscreen

1. Tap the tool icon  on the touchscreen to open the settings menu.
2. Tap Base settings > Wireless range
3. Tap to select the wireless range required: very low, low or normal. Normal is default selected.
4. Tap confirm to apply the settings, and reset the base.

9.3 WIDEBAND AUDIO

The Jabra PRO supports both wideband and narrowband audio. Wideband audio offers better sound quality at a reduced battery time.

Narrowband is default-enabled for desk phones. Wideband is default-enabled for softphones. Mobile phones cannot use wideband audio.

Change wideband audio settings using the touchscreen

1. Tap the tool icon  on the touchscreen to open the settings menu.
2. Tap Phone settings > Desk phone / Softphone (PC)
3. Tap Enable wideband audio to enable.
4. When finished, press the back arrow to exit the menu.

Change wideband audio settings using Jabra Control Center

1. Launch Jabra Control Center, and select the 'Audio' tab.
2. Tick the relevant checkbox under 'Enable wideband audio for', and then click Apply.

9.4 VOICE ANNOUNCEMENTS

Choose to hear an English voice announcement or a musical tone to indicate switching between a desk phone, softphone or mobile phone.

Change voice announcement setting using the touchscreen

1. Tap the tool icon  on the touchscreen to open the settings menu.
2. Tap Headset settings > Voice Announcements
3. Tap to select English voice or Off (tones only). Off (tones only) is default-selected.
4. When finished, press the back arrow to exit the menu.

Change voice announcement setting using Jabra Control Center

1. Launch Jabra Control Center, and select the 'Headset' tab.
2. Tick the relevant setting under 'Target change indication', and then click Apply.

9.5 TONE SETTINGS

Choose between three equalizer presets available for all sounds: Treble, Normal (default) and Bass.

Change tone settings using the touchscreen

1. When on a call, tap the call options icon  on the touchscreen to open the call options menu.
2. Tap Tone Setting to open the tone setting menu.
3. Tick the preferred tone setting. Normal is default-selected.
4. When finished, press the back arrow to exit the menu.

Change tone settings using Jabra Control Center

1. Launch Jabra Control Center, and select the 'Audio' tab.
2. Tick the relevant setting under 'Tone setting', and then click Apply.

9.6 LISTENING TO MUSIC OR AUDIO ON PC

To listen to music or audio played on a PC, an audio link between the Jabra PRO base and the PC must be opened. When an audio link is open and no calls are active, any music or audio played on the PC (including music from a media player) will play in the headset. The Jabra device must be selected in Windows Sound and Audio control panel. Automatic audio link is default-enabled.

Open/Close an audio link between base and PC

1. Launch Jabra Control Center.
2. Click the 'open/close audio link' button in the top toolbar.

Alternatively, right-click the Jabra icon in Windows taskbar, and select 'Open Audio Link' or 'Close Audio Link'.

9.7 FIRMWARE UPDATES

Firmware updates improve performance or add new functionality to your Jabra PRO.

Update Firmware

- Launch the Jabra Firmware Updater installed with Jabra PC Suite, and follow the Firmware Updater wizard, or
- Check for the latest version via Jabra Control Center > Help > Check for Updates.

9.8 THEFT PROTECTION

The base includes a Kensington Security Slot for attaching a security cable. To secure the base to your desk, purchase any safety cable usable with the Kensington Security Slot and follow the instructions included with the cable.

10. FAQs AND TROUBLESHOOTING

Q How can I use my headset with my mobile phone? (Jabra PRO 9465 DUO and Jabra Pro 9470 only)

- A The Jabra PRO 9465 Duo or Jabra PRO 9470 base will need to be paired with the mobile phone using Bluetooth.
- Run the mobile phone setup wizard on the touchscreen to put the headset into pairing mode.
 - Activate Bluetooth on your mobile phone, and then put the Bluetooth into pairing mode. Refer to the mobile phone documentation for details.
 - Find and select either Jabra PRO 9465 Duo or Jabra Pro 9470 in the list of available Bluetooth devices to pair with. If prompted for a PIN, enter 0000 (four zeros) to accept pairing.

Q How many Bluetooth devices can be connected simultaneously to the Jabra PRO 9465 DUO or Jabra PRO 9470?

- A One.

Q How do I pair my headset with the Jabra PRO base?

- A If you dock a headset in a Jabra PRO base that are not paired, the touchscreen will prompt you to accept pairing, either as a primary or secondary device. Secondary pairing is for conference calling. If you choose to pair as secondary, the connection is only temporary until the end of the next (or current) call.

Q Is it possible to dock my headset on another base from the Jabra PRO 9400 series?

- A Yes. The headset can be docked with any Jabra PRO 9400 series base.

Q Can I pair my headset directly with a third-party DECT phone?

- A No. The headset can only be paired with a Jabra PRO 9400 series base.

Q Why doesn't my computer detect the Jabra PRO base?

- A Try connecting the base to another USB port on the PC. It is recommended to have a direct connection between the base and USB port (without a USB hub).

Q Why doesn't my headset work with my desk phone/softphone?

- A Check the following:
- Ensure the headset battery is charged.
 - Ensure the headset is in range of the base. Up to 150 meters, depending on environment. If you are using a Bluetooth connection with a Jabra PRO 9465 DUO or Jabra PRO 9470 ensure the mobile is in range (10m) of the base.
 - Ensure the headset and base are paired. Dock the headset to initiate pairing.

Q Why does nothing happen when I try to use my desk phone?

- A Check the following:
- Ensure the base is powered on.
 - Ensure desk phone is the current target on the touchscreen.
 - Ensure there is an audio connection between desk phone and base. Tap the headset multi-function button or touch the activate audio-link icon on the touchscreen to establish an audio connection.
 - Ensure there is an open phone line. Lift the desk phone handset, or press the headset button on the desk phone, to open a phone line.
 - Re-run the desk phone setup wizard on the touchscreen.

Q Why do I hear a low noise in the headset when there is silence at the other end?

- A The headset speaker volume might be too high. To decrease the volume, slide your finger down the headset touch panel.

Q How come the person on the other end cannot hear me when I am talking using my desk phone?

- A The clear dial tone or microphone volume settings might be incorrectly set. Re-run the desk phone setup wizard on the touchscreen, or read Section 3 of this manual.

Q Can I replace the headset battery?

- A Yes. You can purchase a Jabra PRO battery replacement kit (contact your Jabra supplier, or visit www.jabra.com). Follow the detail replacement instructions supplied with the replacement kit.

Q Why am I getting a buzzing sound in my headset?

A Assuming the device has been set up correctly, the phone may not be fully immune to the radio signals the headset uses. To overcome this problem, move the headset base at least 30 cm away from the phone. Alternatively, reduce the wireless range of your unit.

Q Why can I not hear sound or listen to music from my PC in my headset?

- A Check the following
- Ensure the Jabra PRO is set as the current audio device in the Windows sound control panel, and in your softphone software.
 - Ensure the audio link to your PC is active. Right-click the Jabra Device icon in the Windows taskbar, and select Open Audio Link.
 - Ensure Softphone is enabled in Jabra PC Suite.

Q When I try to make a call on my desk phone, the GN1000 RHL lifts, but the call is not connected.

A Ensure the base is connected to the desk phone handset port, and not the desk phone headset port. The GN1000 cannot be used in conjunction with a headset port.

Q Is it possible to automate calling and answering on my desk phone without using a handset lifter?

A Yes, if the desk phone has an electronic hook switch feature. Check your supplier for compatibility with your phone, and/or consult the support area at www.jabra.com.

Q Is it possible to set up an automatic dial tone for my softphone when I undock my headset?

- A Yes, the Jabra PRO can be configured to automatically get a dial tone on the target desk phone or softphone when the headset is undocked. Automatic dial tones are configured independently for desk phones and softphones. Desk phones are default-enabled, and softphones are default-disabled.
1. Launch Jabra Control Center, and select the 'Desk phone' tab.
 2. Select/deselect the 'Open link when headset is undocked' setting, and then click Apply.

Q Why does my desk phone's electronic hookswitch not work with my headset?

A Please check your specific desk phone documentation for compatibility and configuration settings. Alternatively visit www.jabra.com/PRO9400

Q Is it possible to listen in on calls with the Jabra PRO?

A The risk of unauthorized access is limited. The Jabra PRO uses 64-bit encryption.

Q Does Wi-Fi interfere with the Jabra PRO headset if they are in the same place.

A No. The Jabra PRO 9465 Duo and the Jabra PRO 9470 Bluetooth ports use adaptive frequency hopping, thereby avoiding channels that are blocked by Wi-Fi.

Q What is the range on the Jabra PRO headset?

A Jabra PRO supports a maximum range of up to 150m (base to headset). Range varies according to the environment in which the headset is used.

Q Can I make a conference call using multiple headsets?

A Yes, the Jabra PRO base is able to pair with four headsets in total: one primary and three secondary headsets.

Q Can I turn the headset off to save power when I'm away from the base?

A Yes. Press and hold the headset multi-function button for five seconds to power the headset off. To power the headset up again, dock the headset with the base, or press the headset multi-function button.

Q What is the talk time for a Jabra PRO headset?

A Approximately 8 hours for wideband talk, and approximately 10 hours for narrowband talk.

Q My headband/earhook/neckband is broken. How do I purchase another one?

A Contact your local Jabra supplier. The necessary part number can be found in the optional accessories section of this manual.

11. TECHNICAL SPECIFICATIONS

11.1 ALL JABRA PRO HEADSETS

Operating environment:

-10°C to +55°C (0°C to +40°C when charging); Up to 95% RH non condensing

Call control:

Headset multi-function button support for answer call, end call, voice-activated dialing, reject call, redial, swap held calls; docking operations can also answer and end calls

Volume control and microphone mute:

Controlled via touch panel on headset

Visual indicator:

Multi-colored LED indicates call status, battery level, pairing status and other events

Audio indicators:

Tones indicate incoming calls, low battery, volume level, microphone muting and other events; target phone can be indicated by English voice tag or target-specific melody

Sound quality:

DSP noise reduction; echo cancellation; tone control; narrowband and wideband audio (selectable per phone type)

Firmware update:

Updateable via USB interface when docked in the Jabra PRO base

Recharge:

While docked in the Jabra PRO base

PC-based configuration:

All settings can be stored and loaded from a PC for backup and mass deployment

Wireless standard:

(CAT - iq) European DECT and U.S. DECT

DECT range:

For European DECT; up to 150 meters from Jabra PRO base to headset

For U.S. DECT; up to 135 meters from Jabra PRO base to headset

DECT frequencies:

EU DECT: 1.88 - 1.90 GHz

US DECT: 1.92 - 1.93 GHz

Speaker(s):

Wideband speaker.

11.2 JABRA PRO 9470 HEADSET

Battery Talk Time:

Up to 9 hours - Narrowband audio

Up to 7 hours - Wideband audio

Battery standby time:

Up to 38 hours

Wearing styles:

Ear hook, headband, neckband

Speakers:

1

Microphone:

Dual Noise Blackout™ microphones

11.3 JABRA PRO 9460 HEADSET

Battery Talk Time:

Up to 10 hours - Narrowband audio

Up to 7 hours - Wideband audio

Battery standby time:

Up to 38 hours

Wearing styles:

Ear hook, headband, neckband (either supplied or available as optional accessories)

Speakers:

1

Microphone:

Single Noise-cancelling microphone

11.4 JABRA PRO 9460 DUO AND JABRA PRO 9465 DUO HEADSETS

Battery Talk Time:

Up to 10 hours - Narrowband audio

Up to 7 hours - Wideband audio

Battery standby time:

Up to 38 hours

Wearing styles:

Headband

Speakers:

2 (dual mono)

Microphone:

Single Noise-cancelling microphone

11.5 JABRA PRO HEADSET BATTERY

Battery type:

Lithium Ion

Battery capacity:

315 mA/h, typical

Battery lifetime:

Minimum 500 charge cycles (over 3 years when used for 8 hours a day)

Battery charge time:

2 hours

Shelf life:

Holds a charge for at least 6 months in the off state before recharge is required

Replacement:

Battery lifetime is approximately 3 years with regular use. Contact your Jabra dealer for details on how to order a battery-replacement kit for your headset

11.6 JABRA PRO TOUCHSCREEN BASE

The Jabra PRO base meets the following specifications.

Dimensions:

160mm x 94mm x 82mm

Touchscreen:

2.4 inch touch-sensitive TFT; Q-VGA resolution

Touchscreen functions:

Advanced call handling, system configuration and setup wizard

Recharge cradle:

Fits supplied Jabra PRO headset; features magnetic coupling; easily replaced to accommodate future headset upgrades

Audio:

Built-in speaker provides ring tones and/or audio feedback for touchscreen operation

Audio bandwidth:

Narrowband or wideband

Desk phone connections:

RJ-11 for handset, RJ-11 for phone body (or headset port), RJ-45 for AUX (for electronic hookswitch or GN1000 handset lifter)

Clear dial tone switch and microphone volume switch:

PRO 9460 and 9465 Duo variants only. Electromechanical switches

Remote call control standards:

GN1000, Jabra IQ EHS, Cisco, DHSG, MSH and Siemens optiPoint. Each requires additional cabling and/or equipment available separately; more may become available in future and added via firmware upgrade. GN1000 is supported by default and requires no additional configuration

Busy light indicator:

2.5mm jack connector (available as an accessory)

PC connector:

Micro USB

Firmware update:

Downloadable from web, or via Jabra PC Suite. Language packs also available for touchscreen

PC-based configuration:

All settings can be stored and loaded from a PC for backup and mass deployment

Softphone support:

Full call handling for Skype, Microsoft Office Communicator, Avaya and Cisco IP Communicator; for other softphones see headset as a standard sound card; support for additional softphones may be added via driver updates for the PC. For the latest updates, see jabra.com/pcsuite on the web

Theft protection:

Kensington Security Slot standard

This product contains font software programs which generate human readable typeface designs on base display. The font software family is Frutiger Next licensed to GN Netcom by Linotype

11.7 JABRA PRO 9465 DUO AND JABRA PRO 9470 BASE BLUETOOTH SUPPORT

Bluetooth version:

BT 2.1 Class 2

Bluetooth range:

Up to 10m (class 2)

Bluetooth profiles:

Headset profile (HSP 1.1), hands-free profile (HFP 1.5), device-identification profile (DIP 1.3)

Bluetooth pairing:

1 headset

11.8 MATERIALS AND ALLERGIES

The headband attachment is made of stainless steel and does not have a nickel-coated surface. Nickel release from the headband is 0.02 µg/cm²/week, which is below the 0.50 µg/cm²/week limit established by EU Directive 94/27/EF. The stainless steel alloy was tested for nickel release in accordance with the European standard EN 1811:1998.

Other wearing-style attachments are made of plastic and contain no known allergens. The ear cushions do not contain vinyl. The products contain no nickel, chrome or natural rubber that can come into contact with users' skin.

11.9 PRODUCT DISPOSAL

Please dispose of the headset according to local regulations and recycle when possible. Do not dispose as household waste. Do not dispose of the headset in a fire as the battery may explode. Batteries may also explode if damaged.

11.10 CERTIFICATIONS AND SAFETY APPROVALS

CE

This product is CE marked according to the provisions of the R & TTE Directive (99/5/EC). Hereby, GN declares that this product is in compliance with the essential requirements and other relevant provisions of Directive 1999/5/EC. For further information, please consult <http://www.jabra.com>.

Within the EU, this device is intended for use in Austria, Belgium, Cyprus, Czech Republic, Denmark, Estonia, Finland, France, Germany, Greece, Hungary, Ireland, Italy, Latvia, Lithuania, Luxembourg, Malta, Poland, Portugal, Slovakia, Slovenia, Spain, Sweden, The Netherlands, United Kingdom, and within EFTA in Iceland, Norway and Switzerland.

FCC

This device complies with part 15 of the FCC Rules. Operation is subject to the following two conditions: (1) This device may not cause harmful interference, and (2) this device must accept any interference received, including interference that may cause undesired operation.

Users are not permitted to make changes or modify the device in any way. Changes or modifications not expressly approved by Jabra will void the user's authority to operate the equipment.

This equipment has been tested and found to comply with the limits for a Class B digital device, pursuant to part 15 of the FCC Rules. These limits are designed to provide reasonable protection against harmful interference in a residential installation. This equipment generates, uses and can radiate radio frequency energy and, if not installed and used in accordance with the instructions, may cause harmful interference to radio communications. However, there is no guarantee that interference will not occur in a particular installation. If this equipment does cause harmful interference to radio or television reception, which can be determined by turning the equipment off and on, the user is encouraged to try to correct the interference by one or more of the following measures:

- Reorient or relocate the receiving antenna.
- Increase the separation between the equipment and receiver.
- Connect the equipment into an outlet on a circuit different from that to which the receiver is connected.
- Consult the dealer or an experienced radio/TV technician for help.

The user must place the base 8" (20 cm) or more from any personnel in order to comply with FCC RF exposure requirements.

Industry Canada

Operation is subject to the following two conditions: (1) This device may not cause interference and (2) This device must accept any interference, including interference that may cause undesired operation of the device. The term "IC:" before the certification/registration number only signifies that registration was performed based on a Declaration of Conformity indicating that Industry Canada technical specifications were met. It does not imply that Industry Canada approved the equipment.

Patents and design registration pending international

Jabra®

A BRAND BY

GN Netcom

© 2011 GN Netcom A/S. All rights reserved. Jabra® is a registered trademark of GN Netcom A/S. All other trademarks included herein are the property of their respective owners. (Design and specifications subject to change without notice).

MADE IN CHINA
TYPE: 9400HS/BS



www.jabra.com