



SL-7516 SERIES INDICATOR

USER'S MANUAL

(SL-7516-E, SL-7516-C Series)



TABLE OF CONTENTS

Safety Precautions.....	1
Preparations and Set Up.....	1
Features.....	2
Specifications.....	3
Power Supply.....	4
Displays.....	5
Display and Key Descriptions.....	6
Operating Instructions.....	7-8
Calibration.....	9-10
Indicator Parameter Settings.....	11-13
Definitions.....	14
Connectors.....	15
Communication Mode.....	16
Troubleshooting.....	17
Contact Us.....	17

SAFETY PRECAUTIONS

For safe operation of the weighing indicator, please follow these instructions:

- Calibration inspection and maintenance of the indicator are prohibited by non-professional staff
- Please ensure that the indicator rests on a stable surface
- The indicator is a piece of static sensitive equipment; Please cut off power during electrical connections
- Touching the internal components by hand is prohibited
- DO NOT exceed the rated load limit of the unit
- DO NOT step on the unit
- DO NOT jump on the scale
- DO NOT use this product if any of the components are cracked
- DO NOT use for purposes other than weight taking
- To avoid damaging the battery do not keep charger plugged in once battery is fully charged
- Make sure the weight is not over the Max capacity as it could damage the load cell inside
- Material that has a static electric charge could influence the weighing. Discharge the static electricity of the samples, if possible. Another solution to the problem is to wipe both sides of the pan and the top of the case with an anti-static agent

Please take anti-static prevention measures

Any accumulated charge on the body of the human operator should be discharged first before opening the protective container with ESDS devices inside. The discharge can be accomplished by:

- Putting a hand on a grounded surface or, ideally, by wearing a grounded Anti-static Wrist Strap and an Anti-static Mat

PREPARATION & SET UP

- Plug into a wall outlet to avoid interference with other wirings
- Turn on the balance while there is no load
- We suggest to warm-up the balance by powering on 5 minutes before use for accurate weighing
- Calibration may be required before weighing when the balance is initially installed or moved from a location

FEATURES

Main Functions

- Multiple weighing units: (kg/lb)
- General weighing: Gross/Tare/Zero
- Multiple Hold functions (animal weighing, peak-hold, manual-hold, auto-hold)
- Overload / Underload indication
- Print option
- Low battery reminder
- Automatic Power off (power saving mode)

Technical Parameters

- Accuracy class: 3000 e
- Stimulating voltage: +3.3 VDC
- A/D converting speed 10 SPS
- Load signal range: 0~12.8mV
- Load capacity: can connect 4 pcs 350Ω load cell at most
- Interval: 1/2/5/10/20/50
- Display: 6 digits LED/LCD, word height 20.3mm
- Interface: RS232C
- Baud rate: 1200/2400/4800/9600
- Battery: 4V/4Ah rechargeable battery; 110/220VAC
- AC power: AC 100-250V (use only the included 9V adapter supplied)
- Operation temperature: -10 °C ~ +40 °C
- Operation humidity: ≤90%RH
- Storage temperature: -40 °C ~ +70 °C (32-104°F)

SPECIFICATIONS

INDICATOR MEASUREMENTS

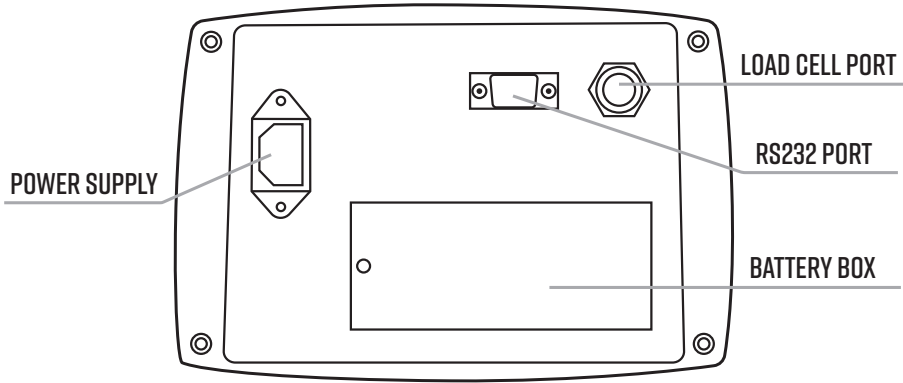
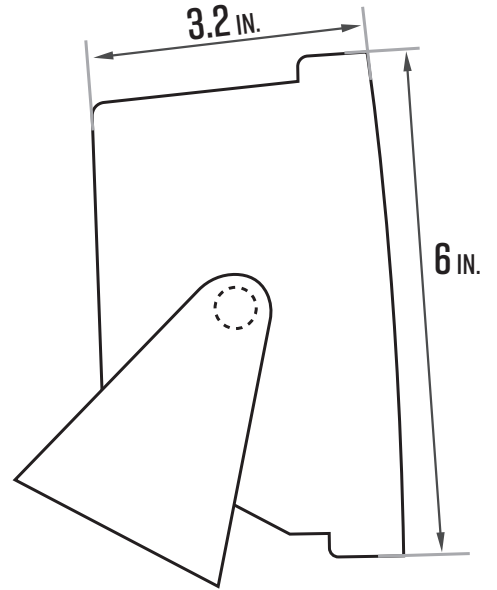
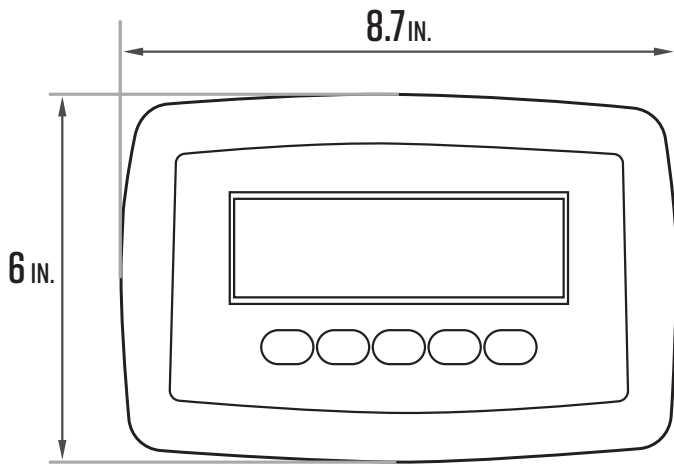

POWER SUPPLY

AC Adapter

The indicator is charged by an ac adapter, plug the adapter directly into the "DC" pin located at the back of the indicator. We recommend to plug into a wall outlet to avoid interference with other wirings. A 110 to 220V AC adapter should be provided with your indicator. Please use only the AC adapter provided to prevent damage to your indicator.



Battery

SL-7516 comes with a rechargeable battery, please charge the internal battery fully before first time use for 10-12 hours to prevent low voltage resulted from self leakage of batter. Once charged the battery should last for 45 hours. To keep the battery in best condition, fully discharge the battery every month by leaving the indicator on until the indicator powers off, and then recharge fully. If the battery is not going to be used for a long period of time it is recommended to remove it to avoid leakage.

On SL-7516-E

- When the Battery is low the battery indicator light flashes red
- During charging the red light will stay lit
- The light will turn green once fully charged

ON SL-7516-C

-  symbol will indicate battery's charge
-  symbol indicates that the battery needs to be charged





SL-7516-E (LED)

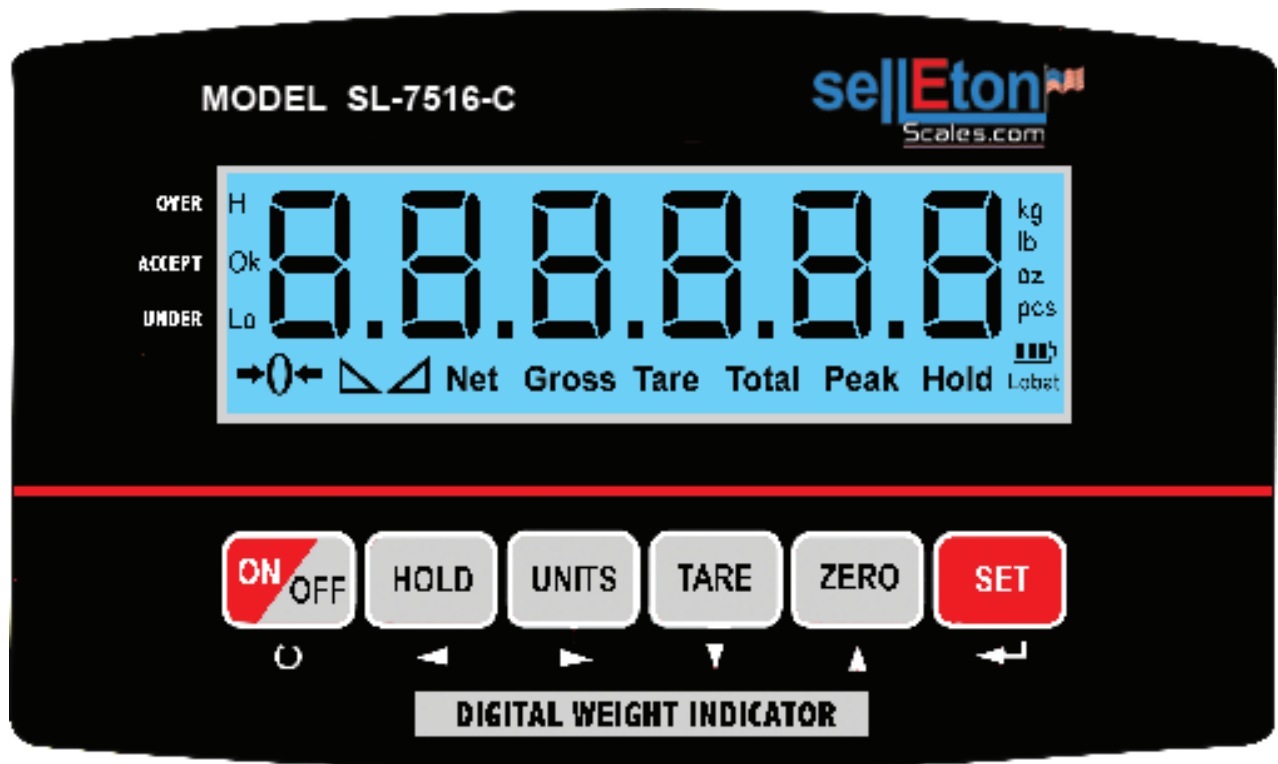

SL-7516-C (LCD)



DISPLAY AND KEY DESCRIPTION

ON/OFF	Powers the Indicator On or Off if held for 2 seconds
HOLD	1. Peak hold - Grabs the highest weight (for tension and pulling force) 2. Data hold - Holds the current weight value (ex. for use with weighing moving animals)
UNITS	Shifts between weighing units (kg/lb)
TARE	1. Zero's the scale. Used when using a container to hold objects 2. Clears the tare to see the gross weight
ZERO	Zero's the scale
SET	Works with the "On/Off" button to enter and exit calibration
	The scale is at zero
	The scale is stable
Gross	Shows you are in Gross weight mode (includes tare); default mode
Net	Shows you are in Net weight mode (without tare)
Tared	Shows you are in Counting mode
Hold	Shows you are in Hold mode
lb	The weight is shown in pounds
kg	The weight is shown in kilograms
Battery	Flashes red = low battery, Solid red = charging, Green = fully charged
Over	Flashes when weight is higher than set alarm parameter
Accept	Flashes when weight is within the set alarm parameters
Under	Flashes when weight is lower than set alarm parameter
	Power
	Arrow keys
	Enter/Return

OPERATING INSTRUCTIONS

Power On

- Turn on the power by pressing the power button for 2 seconds. Once on, the scale will flash the voltage and then begin to auto-check and count down from 0-9 sequentially before entering the weighing mode

Note: Anything on the scale before powering on will automatically be tared out.

Zeroing

- The zero function is used only when the scale is empty and is not at gross zero due to material build up
- Pressing the ZERO key will reset your scale to 0
- Depending on what your manual zero range parameter is set to, you can zero out any number within your set selection, after that you will receive an error and will need to tare out the weight

Unit Selection

- To switch between measuring units (kg, lb, oz) press the UNITS key

Tare Function

- The Tare function is used when you only wish to see the current change in weight, not the entire amount of weight that is on the scale
- When the indicator is in gross mode (gross light is shown) pressing the TARE key will Tare the current weight on the scale and enter the net mode (net light shown)
- For example if you are using a container add the container to the scale, press tare and the display will show the tare symbol $\rightarrow 0 \leftarrow$ and reset back to 0
- Add your item to the scale to weigh without the weight of the container
- To exit Tare mode press the TARE key again to enter gross mode and you will see the total weight of the container and the item

Note: If you remove the container the scale will show the minus weight of the container

Hold

In the parameter settings you can choose one of these 5 hold options

- 1. Peak Hold:** Grabs the highest weight (for materials testing, ie. tension and pulling force)
 - Press the HOLD key then add weight to the scale
 - The indicator will show the highest weight it recorded and hold it on the screen until a higher weight is placed on the scale

- 2. Manual Hold:** Grabs the current weight and holds it so it will not change/fluctuate
 - While weighing, press HOLD and the indicator will hold the current weight on the screen until HOLD is pressed again

- 3. Auto Hold:** If the weight on the scale is above 20d and is stable, the indicator will hold that weight on the screen for 3 seconds then go back to general weighing
 - Pressing the hold key is unnecessary, holding is done automatically when the scale is stable

- 4. Average Hold:** Used for animal weighing, the indicator will display the average weight sampled from 3 or 5 seconds (Set in the C12 Parameter)
 - Add animal to scale and press HOLD
 - Indicator screen will show "LOC" for 3 or 5 seconds, then display the average weight from those 3 seconds
 - Press HOLD again to exit holding mode

- 5. Auto Average Hold:** Used for animal weighing, the indicator will display the average weight sampled from 3 or 5 seconds without the need to press the HOLD key. If the weight on the scale is above 20d and is stable, the indicator will start grabbing the average weight sampled from 3 seconds.
 - Begin loading animal to scale, after 5 seconds the Indicator screen will show "LOC" for 3 seconds
 - It will then display the average weight from those 3 seconds for 3 seconds and then repeat the process































Print

- If the indicator is connected to a printer and the communication mode is set to print mode (C18 =2) and the weight on the scale is stable press and hold the SET key to print the current weight

Print out example:

N.W.:	25.6lb	Net weight
T.W.:	10.3lb	Tare weight
G.W.:	35.9lb	Gross weight
NO.	01	Print out number

CALIBRATION PROCEDURE

1. Turn on the scale by holding ON/OFF  for 2 seconds.
2. Press ON/OFF  and SET  together to access the setup menu.
3. If done correctly, the display should now show **0 1**.
4. Press SET  to access the C1 channel. The display should show [**1** #].
5. Press ZERO  to change the value of C1 to [**2**]. (The value of 2 sets the scale up in pounds.)
6. Press SET  to set the value. The display will now show **02**.
7. Press SET  to access the C2 channel. The display should show [**2** #].
8. Press ZERO  to change the setting to the decimal places desired.
(The C2 channel is used to adjust the decimal point on the scale. A value of 1 means there is one digit behind the decimal point.)
9. Press SET  to set the value. The display will now show **03**.
10. Press SET  to access the C3 channel. The display should show [**3** #].
11. Press ZERO  to cycle through the values until the desired graduation appears.
(The C3 channel adjusts the divisions on the scale. A value of 1 selected and C2 set to 1, the scale will read in 0.1 lb. increments.)
12. Press SET  to set the value. The display will now show **04**.
13. Press SET  to access the C4 channel. The display will show [#####].
14. Enter in the maximum capacity you want to use for this scale by using HOLD  and UNITS  to move the cursor left and right, and TARE  and ZERO  to move the values down and up. (The C4 channel is used to enter in the max capacity of the scale; Make sure this doesn't exceed the max capacity of the scale; Max capacity divided by the increment set in C02 and C03 above cannot exceed 5000)
15. Press SET  to set the value. The display will now show **05**.
16. Press SET  to access the C5 channel. The display should show [**5** 0].
17. The C5 channel calibrates zero on the scale. Make sure the scale is empty.
18. Press ZERO  to change the value to 1.
19. Press SET . The display will count down from 10-1 while the scale is calibrating zero. When the display shows 0 the zero calibration is complete.
20. Press SET  to continue. The display will now show **06**.
21. Press SET  to access the C06 channel. The display will show [**6** 0].
22. The C6 channel is used to calibrate the scale with a known weight. Press ZERO  to set the value of C6 to [**6** !]. Press SET . The display will flash **SPAN**, and then show [#####].
23. Enter the calibration weight value you will use (at least 10% of max capacity you set in C04 by using HOLD  and UNITS  to move the cursor left and right, and TARE  and ZERO  move the values down and up.
24. Place the calibration weight you have on the empty scale and press SET .
25. The scale will count down from 10 to 0. Once 0 has been reached, the display will show **CAL End**.

CALIBRATION cont.

27. Press SET ← to continue. The display will now show [07.
28. Press ON/OFF  to save and exit the setup menu.
29. The scale has now been calibrated. The display will show the value of the calibration weight on the scale.
30. If the scale does not show the value of the calibration weight, check that the feet on the platform are not screwed in too tightly, and verify that the platform is level.
31. Unload the scale; the display should read 000000.
32. If the scale does not display 000000, check that the feet on the platform are not screwed in too tightly, and verify that the platform is level.

INDICATOR PARAMETER SETTINGS

The parameter settings menu has a calibration section (C01 to C06 explained above) and a parameter settings section (C07 and up).

To access the calibration section the seal switch (located at one corner of the PCB) must be OFF. This will allow access to all C01 and up settings. If the seal switch is ON, then only C08 and up can be accessed by the user. If you break the official seal by opening the back of the indicator to access the seal switch, you may need to have the indicator recertified. Be sure to adjust the seal switch back to the original setting after calibration/configuration has been performed.

To enter calibration/parameter settings, follow the procedure below:

1. Press and hold the ON/OFF and SET key at the same time for 2 seconds
2. Navigate through the settings (C01 to C45) as shown in the table 4 below by using the arrow keys and enter key as labeled under each indicator button
3. Press the SET  key to enter/edit the parameter setting
4. Press the ON/OFF key to save and exit settings at any time

Table 1. Calibration Parameter Settings

Function	Parameter	Settings/Options
Weighing Unit	C01	1 = kg 2 = lb
Decimal Setting	C02	0 = no decimal 1 = #.# 2 = #.## 3 = #.### 4 = #.####
Division/ Graduation Setting (readability of the least significant digit)	C03	options: 1/2/4/10/20/50 Example with no decimal places (ie C02=0) 1 = 1 lb 2 = 2 lb 5 = 5 lb 10 = 10 lb 20 = 20 lb 50 = 50 lb
Maximum Capacity	C04	set max capacity ex. 100kg = [0100.00]
Zero Calibration	C05	0 = zero calibration 1 = set the zero calibration Note: Before calibrating please ensure scale is empty and the stable light is on. When calibrating the Indicator will count down from 10 to 0
Calibration	C06	0 = calibration not needed 1 = ready to calibrate with calibration weight Note: When calibrating the display will flash SPAn, telling you to input the value of the calibration weight you will be using. Once set the scale will count down from 10 to 0 and display Cal-End, and the calibration will be complete.

Table 2. Indicator Parameter Settings

Function	Parameter	Settings/Options
Restore Default Settings	C07	0 = do not restore 1 = restore to default settings
Warning Tone	C08	0 = turn off warning tone 1 = turn on warning tone
Power Off Automatically	C09	0 = turn off auto power off 10 = power off automatically if no change within 10 minutes 30 = power off automatically if no change within 30 minutes 60 = power off automatically if no change within 60 minutes
Power Saving Mode	C10	LED Version SL-7516-E: 0 = turn off power saving setting 3 = turn off display if no change within 3 minutes 5 = turn off display if no change within 5 minutes LCD Version SL-7516-C: 0 = turn off the backlight 1 = backlight only when the weight changes or keyboard is pressed 2 = constant backlight
Hold Function	C11	0 = turn off hold function 1 = Peak hold - Grabs the highest weight 2 = Manual hold - Grabs the current weight 3 = Auto hold - Automatically holds data when stable 4 = Average hold - for animal weighing, averages the weight from a sample of 3 or 5 seconds (Set in parameter C12) 5 = Auto Average hold - Average hold without the need to press the hold key
Hold Time	C12	If you chose C11=4 this setting allows you to set how many seconds it samples to obtain an average weight 3 = 3 seconds 5 = 5 seconds
Upper Limit Alarm	C13	Set upper limit within the max. capacity
Lower Limit Alarm	C14	Set lower limit within the max. capacity
Inner Code Display	C15	Check the inner code (raw data)
Communication Setting	C18	Set the serial interface data output method: 0 = Turn off serial interface data output 1 = Continuous sending mode, connect remote display 2 = Print mode, connect printer 3 = n/a 4 = PC continuous sending mode, connect computer
Baud Rate	C19	0=1200 (for remote display) 1=2400 2=4800 3=9600
Manual Zero Range	C20	0 = turn off manually zero setting 1 = ±1% max capacity 2 = ±2% max capacity 4 = ±4% max capacity 10 = ±10% max capacity 20 = ±20% max capacity 100 = ±100% max capacity

Function	Parameter	Settings/Options
Initial Zero Range	C21	0 = no initial zero setting 1 = ±1% max capacity 2 = ±2% max capacity 5 = ±5% max capacity 10 = ±10% max capacity 20 = ±20% max capacity
Zero Tracking	C22	0 = turn off zero tracking 0.5 = ±0.5d 1.0 = ±1.0d 2.0 = ±2.0d 3.0 = ±3.0d 4.0 = ±4.0d 5.0 = ±5.0d Note: the zero tracking range can not be bigger than manual zero range d = division
Zero Tracking Time	C23	0 = turn off zero tracking time 1 = 1 second 2 = 2 seconds 3 = 3 seconds
Overload Range	C24	00 = turn off overload range 01-99d = overload range setting d = division
Negative Display	C25	0 = -9d 10 = -10% max. capacity 20 = -20% max. capacity 50 = -50% max. capacity 100 = -100% max. capacity
Standstill Time	C26	0 = quick 1 = medium 2 = slow
Standstill Range	C27	1 = ±1d 2 = ±2d 5 = ±5d 10 = ±10d d = division
Digital Filter (for filtering moving weight, such as animals)	C28	0 = turn off dynamic filter 1 = Low dynamic filter 3 = Medium dynamic filter 5 = High dynamic filter
Noise Filter	C29	0 = turn off noise filter 1 = Low 2 = Medium 3 = High
Print Time and Date	C30	0 = yy.mm.dd 1 = mm.dd.yy 2 = dd.mm.yy 3 = yy.mm.dd
Gravity of Calibration Location	C36	9.7000 - 9.9999
Gravity of Destination	C37	9.7000 - 9.9999
Version No.	C38	
Input Signal	C39	0 = Input Signal Direction Normal 1 = Input Signal Direction Reversed

HELPFUL DEFINITIONS

Division: The amount of increments a scale offers. How accurate the scale can be

Capacity: the maximum amount the scale can contain

Initial Zero Range: The percentage of weight allowed on the scale when indicator is powered on that will automatically zero.

example: If initial zero range is set to 10% of the max. capacity and your max. capacity is 100lbs, you can place up to 10lbs of weight on the scale and when the indicator is powered on, it will automatically zero out the weight.

Manual Zero Range: The percentage of weight allowed on the scale where the indicator will let you manually zero (anything above this percent will be tared)

Zero Tracking Range: A subset to the manual zero range; if the weight on the scale is not stable, the zero tracking range still allows you to zero within a set division of the scale

Zero Tracking Time: A subset to the zero tracking range, it is the time allowed for the scale to fall within the zero tracking range tolerance and still qualify to be zero'd

Overload Range: Weight allowance that is out of the set calibrated range. Adds a tolerance to the calibrated max. capacity without having to recalibrate.

example: If your scale has a max. capacity of 1000lbs with a division of 1 and you set the overload range to 60, you can add 1060lbs of weight to the scale without it displaying an error code

Negative Display: How far you can go in the negative direction before displaying an error code

Standstill Time: How fast the scale will stabilize

Standstill Range: How much the scale can fluctuate before being determined stable

Digital Filter: For filtering moving weight, such as animals, It changes how sensitive the scale is to variations in movement.

Noise Filter: A filter for how susceptible the scale is to general variations

Baud Rate: The rate at which information is transferred in a communication channel.

example: In the serial port context, "9600 baud" means that the serial port is capable of transferring a maximum of 9600 bits per second.

CONNECTORS

Connecting load cells to the indicator

- The indicator can connect with 4 pcs load cells of 350Ω at most
- 4 wire or 6 wire load cell connections are both okay
- Please contact us directly if you have other special needs for your application

Quick Disconnect as shown below:

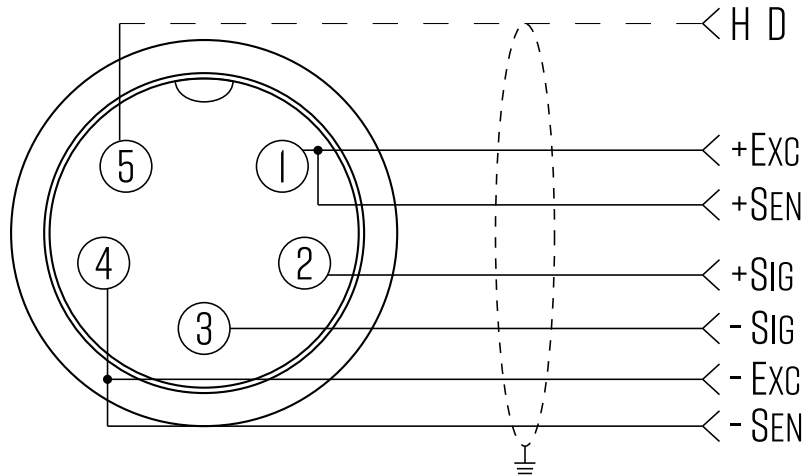

QUICK DISCONNECT CONNECTION DIAGRAM

DB9 SERIAL CONNECTOR PINOUT

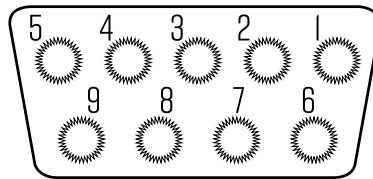

DB9 Pin Description

DB9 Pin	Definition	Function
2	TXT	Transmit Data
3	RXD	Receive Data
5	GND	Ground Interface

COMMUNICATION MODE

Continuous sending mode for PC: the indicator continuously sends the data to the RS232 port

Communication Format is done using ASCII as shown below:

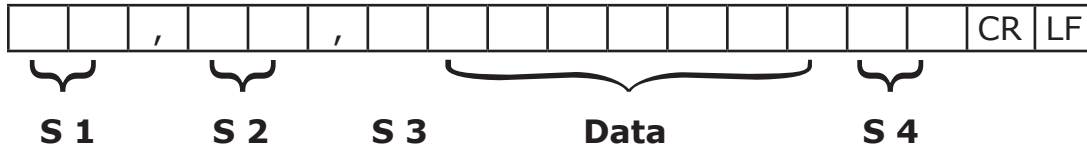

- S1: weight status, ST=standstill, US=not standstill, OL=overload
- S2: weight mode, GS=gross mode, NT=net mode
- S3: weight of positive and negative, "+" or "-"
- Data: weight value, including decimal point
- S4: "kg" or "lb"
- CR: carriage return
- LF: line feed

TROUBLESHOOTING

Error Codes

Error	Reason	Solution
UUUUUUU	<ol style="list-style-type: none"> 1. Overload 2. Wrong connection with load cell 3. Load cell has quality problem 	<ol style="list-style-type: none"> 1. Reduce the weight 2. Check load cell connection 3. Inspect load cell; Check the input/output
nnnnnnnn	<ol style="list-style-type: none"> 1. Calibration is no good 2. Wrong connection with load cell 3. Load cell has quality problem 	<ol style="list-style-type: none"> 1. Make sure scale is level 2. Check load cell connection 3. Check load cell input and output resistance
Err 1	During calibration, weight is not used or the weight is above the max. capacity	Use correct weight within the defined range
Err2	During calibration, the weight is below the minimum required weight	The calibration weight minimum is 10% of the max. capacity set in C04. Recommended to use 60%-80% of max. capacity if possible
Err3	During calibration, the input signal is negative	<ol style="list-style-type: none"> 1. Check all wire connections 2. Check load cell 3. Recalibrate 4. PCB replacement needed if steps 1-3 fail
Err4	During calibration signal is unstable	After the platform is stable, start calibration
Err5	EEPROM Error	Change PCB

CONTACT US

Please e-mail info@selletoncales.com for any sales related questions or

call 844-735-5386

Don't forget to visit our website at:

www.selletoncales.com