

TABLE OF CONTENTS

Safety Precautions.....	1
Features.....	2
Specifications.....	3
Display and Key Descriptions.....	4
Operating Instructions.....	5
Rear Panel.....	6
General Functions.....	7
Function Settings.....	8
Parameter Settings.....	9-10
Calibration Settings.....	11-14
Check Weighing Configuration.....	15
Cable Connection Manual.....	16-18
Troubleshooting.....	19
Contact Us.....	19

SAFETY PRECAUTIONS

For safe operation of the weighing indicator, please follow these instructions:

- Calibration inspection and maintenance of the indicator are prohibited by non-professional staff
- The indicator is a piece of static sensitive equipment; Please cut off power during electrical connections
- Touching the internal components by hand is prohibited
- DO NOT exceed the rated load limit of the unit
- DO NOT step on the unit
- DO NOT jump on the scale
- DO NOT use this product if any of the components are cracked
- DO NOT use for purposes other than weight taking
- To avoid damaging the battery do not keep charger plugged in once battery is fully charged
- Make sure the weight is not over the Max capacity as it could damage the load cell inside
- Material that has a static electric charge could influence the weighing. Discharge the static electricity of the samples, if possible. Another solution to the problem is to wipe both sides of the pan and the top of the case with an anti-static agent
- Plug into a wall outlet to avoid interference with other wirings
- Calibration may be required before weighing when the scale is initially installed or moved from a location

FEATURES

- LED 6 digit display
- Multiple weighing units: kg/lb/t
- Gross/Tare/Hold/Zero
- Check weighing feature

Technical Parameters

Hardware construction features

- Power supply: 24vDC
- Load cell excitation voltage: 5vDC \pm 5%
- Load cell number: up to eight 350 Ω
- Load cell sensitivity: 0~3.0mv/v
- Load cell connections: six wire
- Keyboard: six key
- Display: six digits red 7 segment LED display
- Relay output: 4 output, AC250v 5A
- Input: isolation voltage 2500V
- Analog output: 4~20mA/0~5v
- Serial port: RS232/RS485, baud rate 600~19200bit/s
- Operation temperature: -10 °C ~ +40 °C
- Operation humidity: \leq 90%RH
- Storage temperature: -40 °C ~ +70 °C (32-104°F)
- Housing dimension: 92 x 45mm
- Front panel dimension: 102 x 55mm
- Trepanning dimension: 93 x 46mm

Software features

- Max sampling speed: 120SPS
- AD digital filter
- Digital calibration
- Batching or dosing functions

SPECIFICATIONS

FIGURE 1: INDICATOR MEASUREMENTS

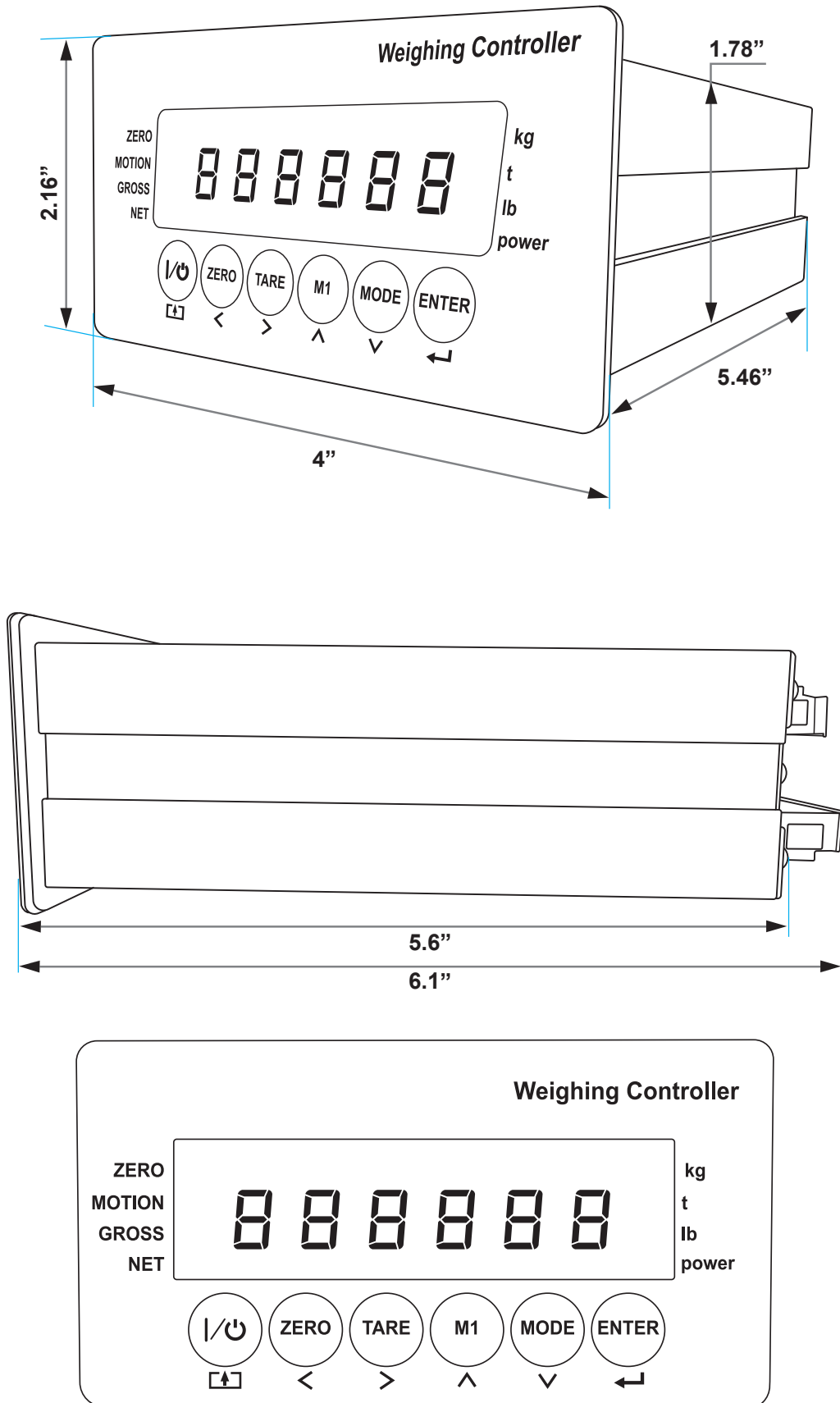

OPERATING INSTRUCTIONS

Power On

- Turn on the power by pressing the power button for 2 seconds. Once on, the scale will flash the voltage and then begin to auto-check and count down from 0-9 sequentially before entering the weighing mode

Note: Anything on the scale before powering on will automatically be tared out.

Zeroing

- The zero function is used only when the scale is empty and is not at gross zero due to material build up
- Pressing the ZERO key will reset your scale to 0
- Depending on what your manual zero range parameter is set to, you can zero out any number within your set selection, after that you will receive an error and will need to tare out the weight

Tare Function

- The Tare function is used when you only wish to see the current change in weight, not the entire amount of weight that is on the scale
- When the indicator is in gross mode (gross light is shown) pressing the TARE key will Tare the current weight on the scale and enter the net mode (net light shown)
- For example if you are using a container add the container to the scale, press tare and the display will show the gross light and reset back to 0
- Add your product to the scale to weigh without the weight of the container
- To exit Tare mode press the TARE key again to enter gross mode and you will see the total weight of the container and the product

Note: If you remove the container the scale will show the minus weight of the container

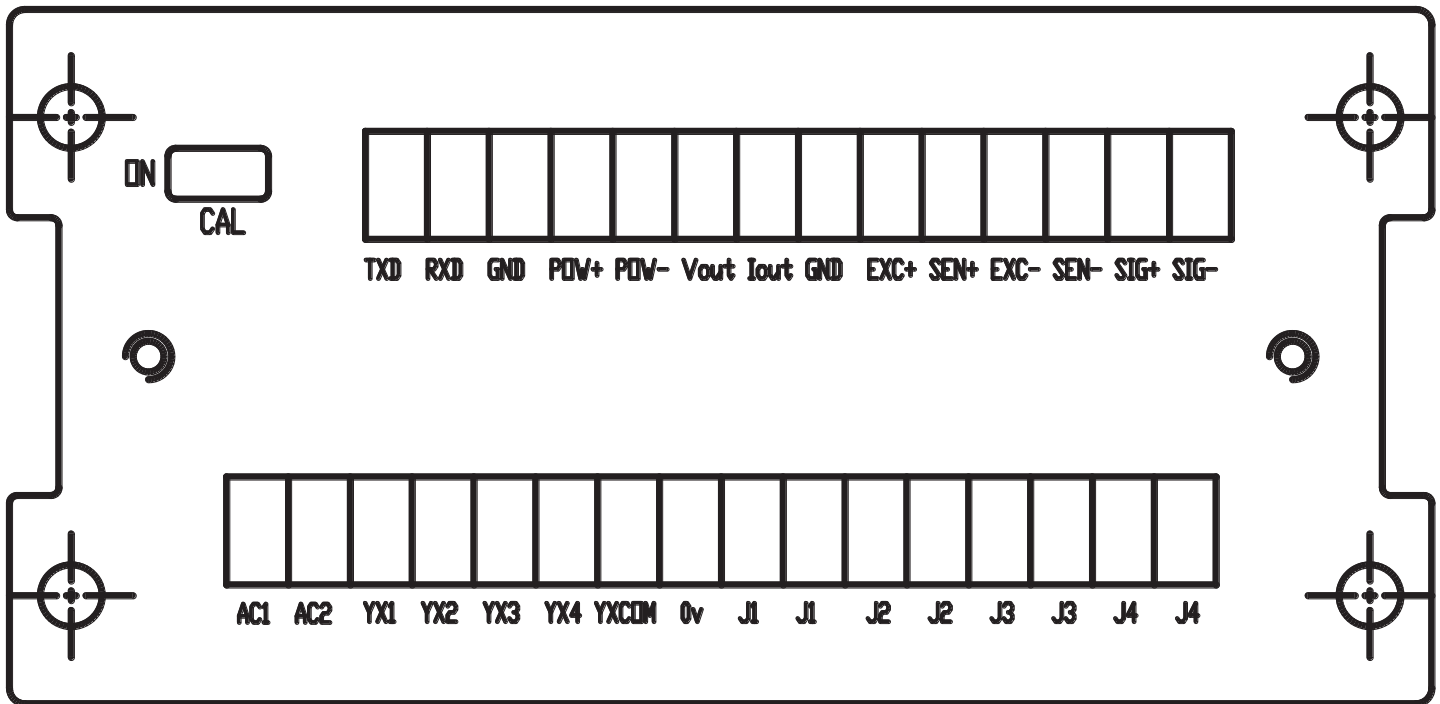

REAR PANEL

Connection definition:

Power: POW+ POW- for 24VDC, AC1 AC2 for 220VAC

Load cell: EXC+ SEN+ EXC- SEN- SIG+ SIG

Serial communications: TXD RXD GND for RS232, A B for RS485

Analog output: Vout Iout GND









Relay output: J1 J1 J2 J2 J3 J3 J4 J4

Input: YX1 YX2 YX3 YX4 YXCOM 0v To exit Tare mode press the TARE key again to enter gross mode and you will see the total weight of the container and the product







Note: If you remove the container the scale will show the minus weight of the container

GENERAL FUNCTIONS

Function setup and operation procedure:

Function	Operation	Display	Remark
Enter calibration mode	Turn the calibration switch to "ON"	01 CSP	4
Enter function setting	Weight mode, press  and 	01 FnC	3.3
Check weighing setpoint parameter setting	Weight mode, press 	1.FinAL	5
Enter to test mode	Turn power on, press  and 	1. dsp	7.1
Reset all parameters back to default	Turn power on, turn the calibration switch to "ON", press  and 	i.ALL	7.2
Reset general function parameters back to default	Turn power on, press  and 	1 FnC	7.2

Parameter Settings, Key meaning

Key	Meaning
	Save and Exit
	Move the flashing digit to the left
	Move the flashing digit to the right
	Increase the flashing digit
	Decrease the flashing digit
	Confirm

FUNCTION SETTINGS

Press  at the same time to enter the function settings

The screen will display "01 FnC" for function setting

Press  to display "02 232" for serial port interface

Press  to display "03 Sq " for weight comparison procedures

Press  to display "04 AnL" for analog current output

Press  to display "05 In " for external input interface



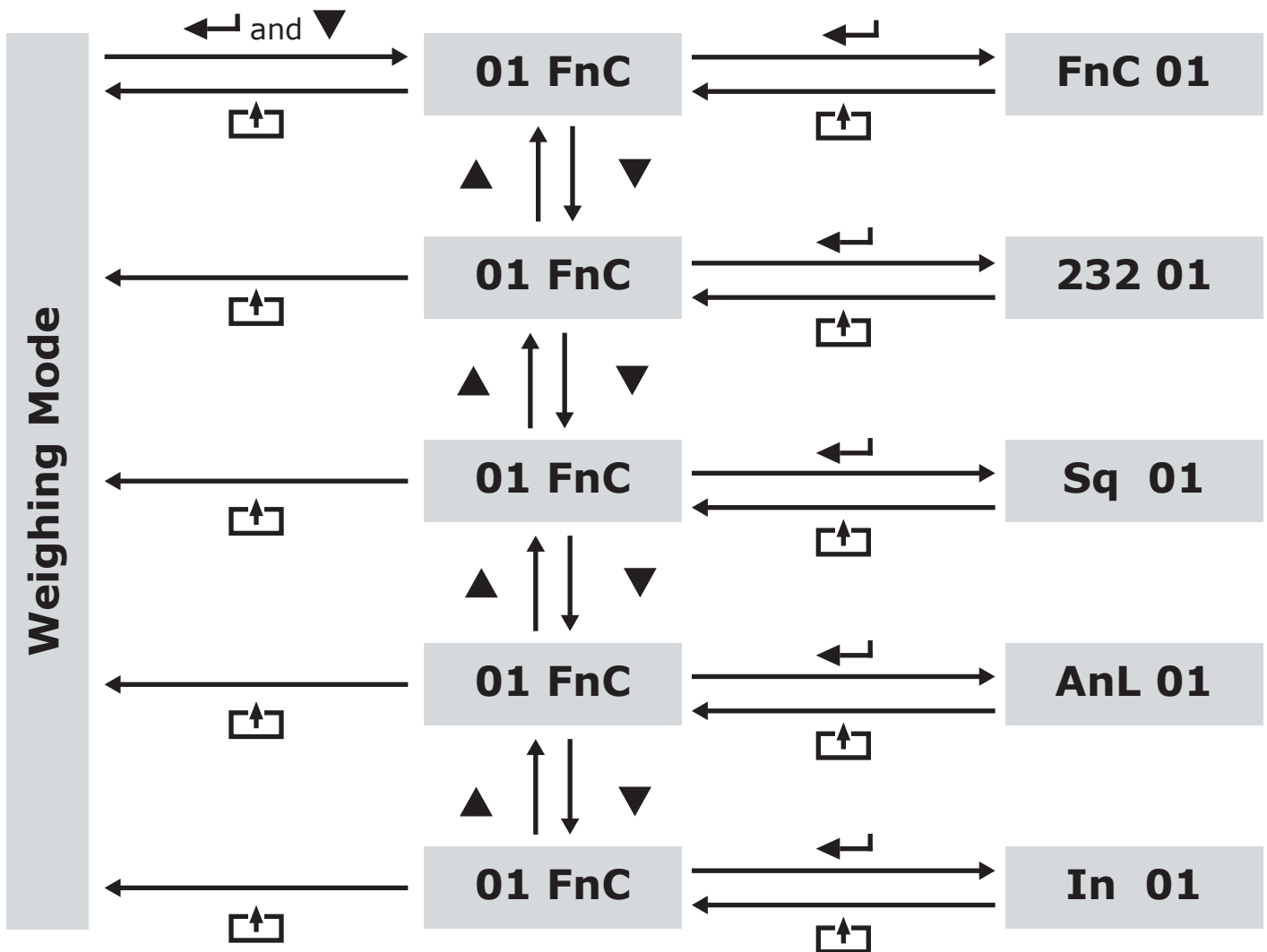

Press  to enter the next menu level

Press  to save and exit out of this menu and restart



INDICATOR PARAMETER SETTINGS

To enter parameter settings, follow the procedure below:

1. Press ENTER  and MODE  at the same time for 2 seconds to enter the function settings
2. Navigate through the settings as shown in the table below by using the arrow keys and return keys as labeled under each indicator button
3. Press the ENTER  key to enter/edit the parameter setting
Press the  key to save and exit settings at any time

01 FnC Function Parameter Code				
Function	Item	Parameter	Description	Default
Digital Filter 1	FnC 01	00 01 ... 10	Greater ↓ Less	03
Digital Filter 2	FnC 02	00 01 02 03	Greater ↓ Less	02
Rate for display rewrite	FnC 03	01 05 10 20 120	1 times/sec 5 times/sec 10 times/sec 20 times/sec 120 times/sec	10

02 232 Serial Port Interface				
Function	Item	Parameter	Description	Default
Baud Rate	232 01	00 01 02 03 04 05	600bit/s 1200bit/s 2400bit/s 4800bit/s 9600bit/s 19200bit/s	04
Transmit Mode	232 02	00 01 02 03 04	close serial port continuous print mode stable send command mode	01
Data Format	232 03	00 01 02	format 1 format 2 print format	00
Transmit Time	232 04	00 01 02 03	open 1 sec 2 sec 5 sec	00
Address for Multi-computer	232 05	00 01~99	Only one Address (bcd)	00

03 Sq Weight Comparison Procedures

Function	Item	Parameter	Description	Default
Batching Mode	59 01	00	normal batch less-in weight comparison	01
		01		
		02		
		03		
		04		
Control Mode	59 02	01	manual start auto for custom	01
		02		
		03		
Comparison Format	59 03	01 02	net gross	01
Start Delay	59 04	00	no delay 1 sec delay ... 10 sec delay	01
		01		
		...		
		10		
Stable Time	59 05	00	no wait 1 sec wait ... 10 sec wait	03
		01		
		...		
		10		

04 Analog Current Output

Function	Item	Parameter	Description	Default
Signal output	AnL 01	00	4~20mA current 0~20mA current 0~5v voltage	00
		01		
		02		
Data format	AnL 02	00 01	display weight gross weight	00
Maximum weight	AnL 03	010000	when max analog output weight	010000
Zero adjust	AnL 04	4mA/0mA/0v	Press ▲ or ▼ to adjust output	4
Linearity adjust	AnL 05	20mA/5v	Press ▲ or ▼ to adjust output	20
Output range limit	AnL 06	00	no limit limit	00
		01		

05 External Input Interface

Function	Item	Parameter	Description	Default
INPUT1	In 01	00	no function zero	01
INPUT2				
INPUT3	In 02	02	tare gross	02
		03		
INPUT4	In 03	04	hold total	05
		05		
	In 04	06	print	06

CALIBRATION SETTINGS

To enter calibration settings, follow the procedure below:

1. In weighing mode, make sure calibration switch is set to "ON"
2. The display will show "01 CSP" meaning you entered the calibration parameter code
 - Press **←** to enter the next step level
 - Follow the steps in the parameters to set up your calibration
3. Press **▲** to display "02 CAL" General calibration
 - Follow the steps to calibrate your scale
4. Press **▲** to display "03 CUo" Sensitivity calibration
 - Follow the steps to set filters and manage the sensitivity of your scale
5. When you are done with calibrating, make sure to turn the switch to "OFF"
6. The screen will display "End" , save the data and restart

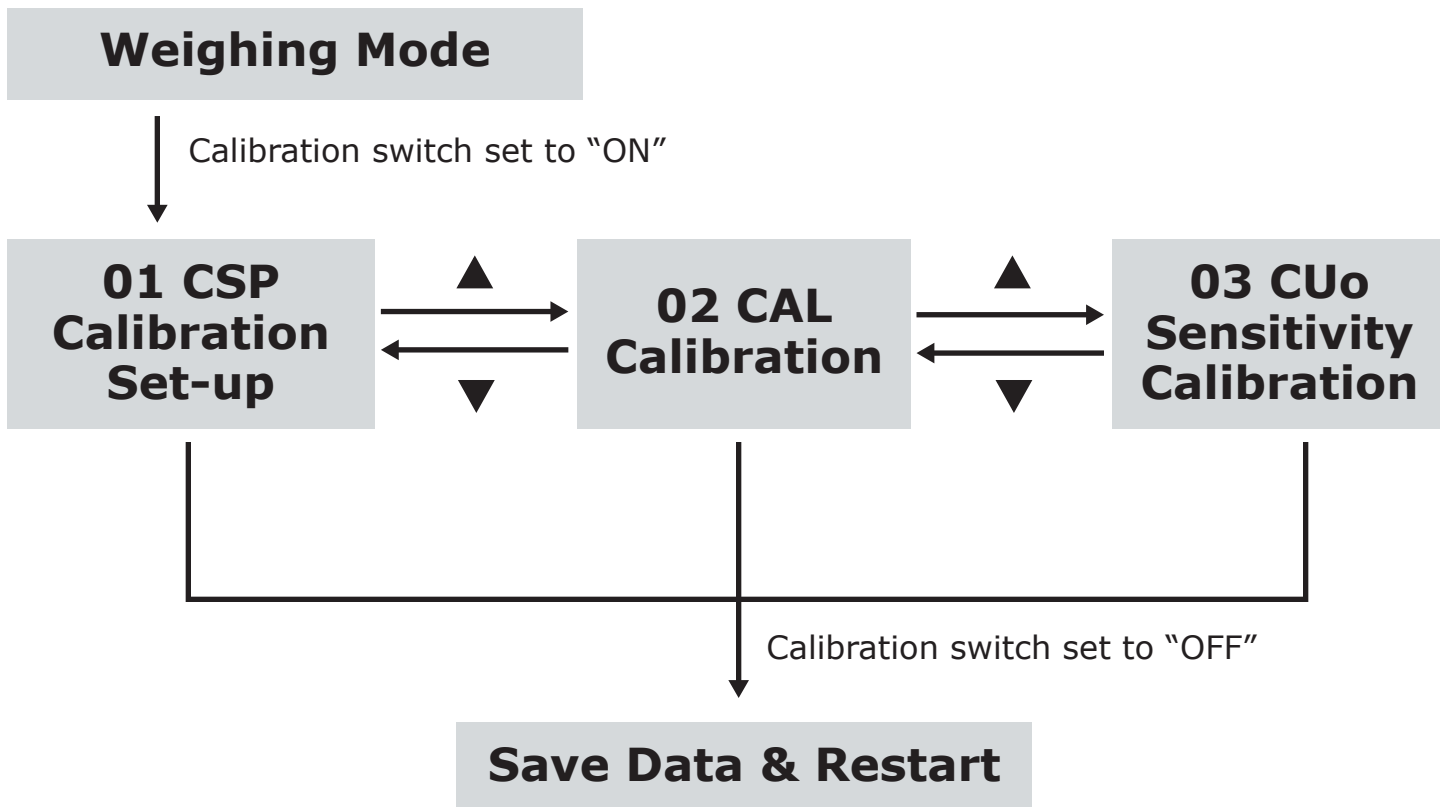

"01 CSP" Calibration Parameter Code

01 CSP Calibration Parameter Code				
Function	Item	Parameter	Description	Default
Unit	CSP 01	01 02 03	kg lb t	01
Decimal point	CSP 02	00 01 02 03 04	none 1 decimal point 2 decimal point 3 decimal point 4 decimal point	00
Division	CSP 03	01 02 05	division size	02
Max Capacity	CSP 04	010000	Max capacity	1000
Zero-Setting range	CSP 05	00 01 02	0 ±1% ±2%	02
Initial zero-setting range	CSP 06	00 01 02 05 10	0 ±1% ±2% ±5% ±10%	10
Automatic zero-setting range	CSP 07	00 05 10 20	0 0.5d 1d 2d	05
Automatic zero-setting time	CSP 08	00 01 02 03	0 1 sec 2 sec 3 sec	01
Stable time	CSP 09	00 01 02	fast medium slow	01
Stable range	CSP 10	01 02 05 10	1d 2d 5d 10d	02
Automatic zero	CSP 11	00 02 05 10 20	no -2d -5d -10d -20d	02
Preserved Menu	CSP 12			

"02 CAL" Calibration

In weighing mode set calibration switch to "ON"

Calibration press ▲

To enter calibration press ←

Zero calibration press ←

Skip zero calibration press ↻

Display zero code

3 seconds

Weight calibration press ←

Skip weight calibration press ↻

Use ▲ ▼ ◀ ▶ to set the weight

Once the weight is stable press ←

Sensitivity

3 seconds, calibration done

Set calibration switch to "OFF"

You are finished

Note: Zero calibration, can be no more than 5mv.

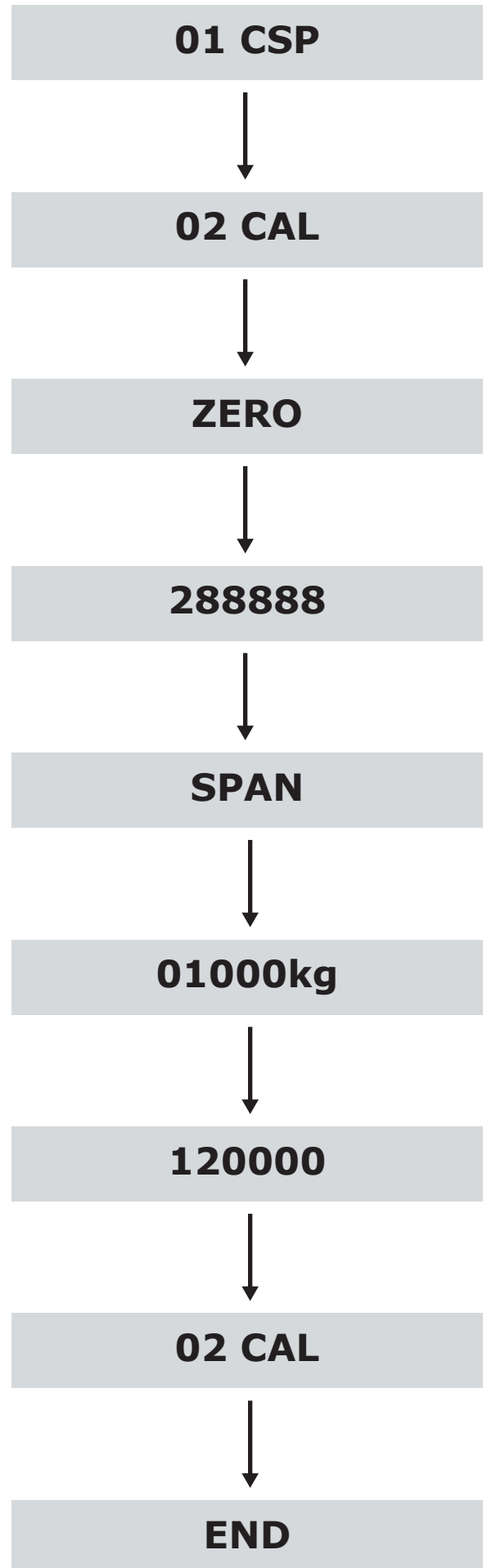

"03 CUo" Sensitivity Calibration

In weighing mode set calibration switch to "ON"

Sensitivity Calibration press ▼

To enter calibration press ←

Zero calibration press ←

Skip zero calibration press ↻

Auto gather zero code

Or press ◀ to set zero code

to enter zero calibration ←

Sensitivity calibration press ←

Skip sensitivity calibration press ↻

Use ▲ ▼ ◀ ▶ to set the sensitivity
enter press ←

Sensitivity calibration done

Set calibration switch to "OFF"

You are finished

Sensitivity = $100000 \times \text{load cell full scale output} \times \text{weighing meter capacity} / (N \times \text{Load cell capacity})$

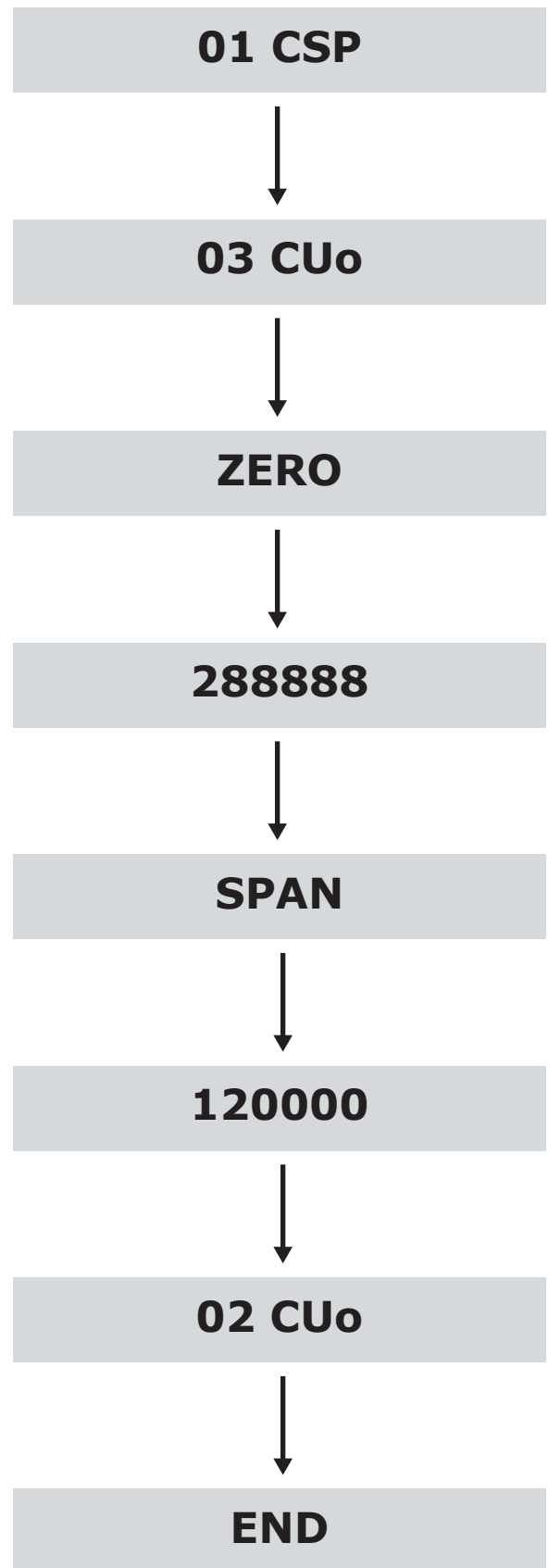

CHECK WEIGHING CONFIGURATION

Weighing mode press ▼ to go enter parameters

Display	Function
1. FinAL	Final value
2. SP1	SP1 value
3. SP2	SP2 value
4. SP3	SP3 value
F. FALL	Free fall value
6. oVer	Over value
7. UndEr	Under value
8. Z.bAnd	Zero band

Warning: set FinAL > SP1 > SP2 > SP3 > F. Fall

set Sq01=1: net weigh

Signal	Output Condition	Relay Output
SP1	Net \geq Final-SP1	J1
SP2	Net \geq Final-SP2	J2
SP3	Net \geq Final-SP3	J3
Free Fall	Net \geq Final-F.FALL	J4

Set Sq01=3:

Signal	Output Condition	Relay Output
HI	Net \geq SP1	J1
OK	SP1 \geq Net \geq SP2	J2
LO	Net < SP2	J3

CABLE CONNECTION MANUAL

Power

POW+	24VDC+
POW-	24VDC-
AC1	220VAC
AC2	220VAC

Load cell

EXC+
SEN+
EXC-
SEN-
SIG+
SIG-

NOTE: use 4-wire load cell need EXC+ and SEN+ short connect, EXC- and SEN- short connect.

Serial Port

TXD RS232 transmission RXD RS232 receive GND RS232 GND A RS485 A B RS485 B

Analog Output

Vout 0~5v voltage, load more than 1k Ω

Iout 4~20mA current, load span 100~500 Ω

GND GND

Relay Output

J1 J1 first group relay output

J2 J2 second group relay output

J3 J3 third group relay output

J4 J4 fourth group relay output

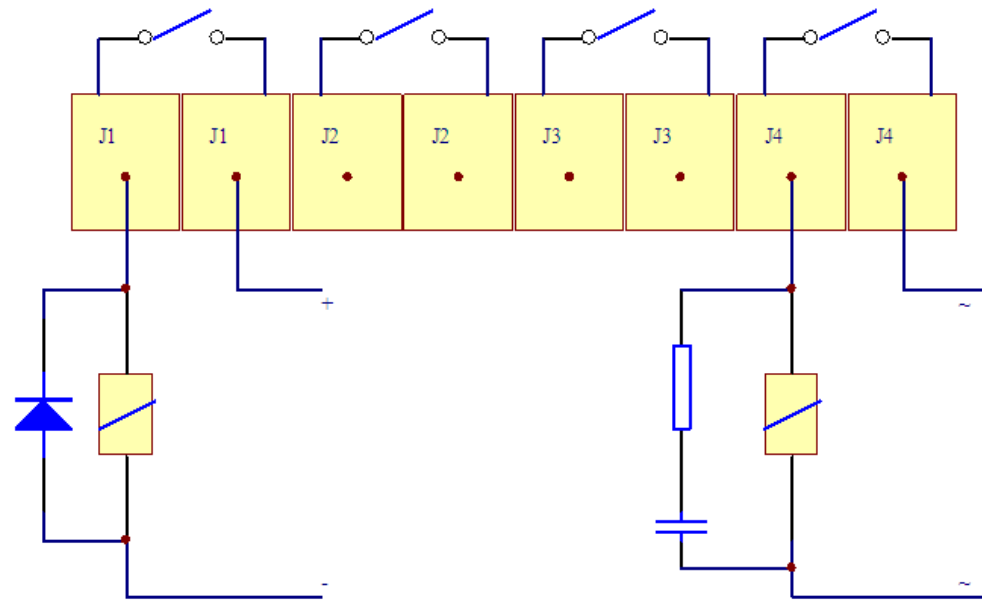

Relay Output Connection diagram

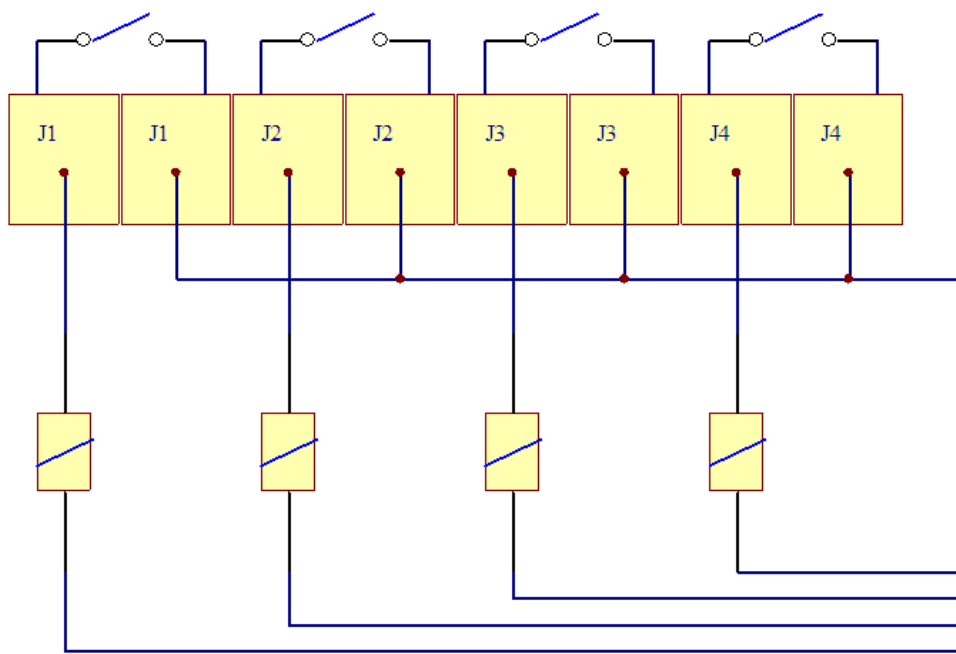

Common connection diagram

Note: Use common connection, put one of J1, J2, J3, J4 short connect.

