

OP-900-LD INDICATOR USER'S MANUAL



TABLE OF CONTENTS

Safety Precautions.....	1
Preparations and Set Up.....	1
Features.....	2
Power Supply.....	2
Specifications.....	3
Remote Control.....	4
Display and Key Descriptions.....	4
Operating Instructions.....	5-6
Calibration.....	7-8
Indicator Parameter Settings.....	9-11
Helpful Definitions.....	12
Connectors.....	13
Troubleshooting.....	14
Q&A.....	15
Contact Us.....	16

SAFETY PRECAUTIONS

For safe operation of the weighing indicator, please follow these instructions:

- Calibration inspection and maintenance of the indicator are prohibited by non-professional staff
- Please ensure that the indicator rests on a stable surface
- The indicator is a piece of static sensitive equipment; Please cut off power during electrical connections
- Touching the internal components by hand is prohibited
- DO NOT exceed the rated load limit of the unit
- DO NOT step on the unit
- DO NOT jump on the scale
- DO NOT use this product if any of the components are cracked
- DO NOT use for purposes other than weight taking
- To avoid damaging the battery do not keep charger plugged in once battery is fully charged
- Make sure the weight is not over the Max capacity as it could damage the load cell inside
- Material that has a static electric charge could influence the weighing. Discharge the static electricity of the samples, if possible. Another solution to the problem is to wipe both sides of the pan and the top of the case with an anti-static agent

Please take anti-static prevention measures

Any accumulated charge on the body of the human operator should be discharged first before opening the protective container with ESDS devices inside. The discharge can be accomplished by:

- Putting a hand on a grounded surface or, ideally, by wearing a grounded Anti-static Wrist Strap and an Anti-static Mat

PREPARATION & SET UP

- Plug into a wall outlet to avoid interference with other wirings
- Turn on the indicator while there is no load
- Calibration may be required before weighing when the scale is initially installed or moved from a location

FEATURES

- Large 3" Ultra bright LED display
- Multiple weighing units: kg/lb
- Gross/Tare/Zero
- Accumulation weighing
- Power saving mode
- Remote with antenna
- Mounting bracket

Technical Parameters

- Accuracy class: 5000 e
- Resolution - Display: 30,000 ; ADC: 2,000,000
- Zero stability error: $TK0 < 0.1\mu V//K$
- Span stability error: $TKspn < \pm 6 \text{ ppm//K}$
- Sensitivity (internal): $0.3 \mu V / d$
- Input voltage: -30 to +30mV DC
- Excitation circuit: 5 VDC, 4 wire connection, 6 load cell of 350ohm max
- AC power: AC 100-250V (use only the included 9V adapter supplied)
- Operation temperature: $-10 \text{ }^\circ\text{C} \sim +40 \text{ }^\circ\text{C}$
- Operation humidity: $\leq 90\%RH$
- Storage temperature: $-40 \text{ }^\circ\text{C} \sim +70 \text{ }^\circ\text{C}$ (32-104°F)

AC Adapter





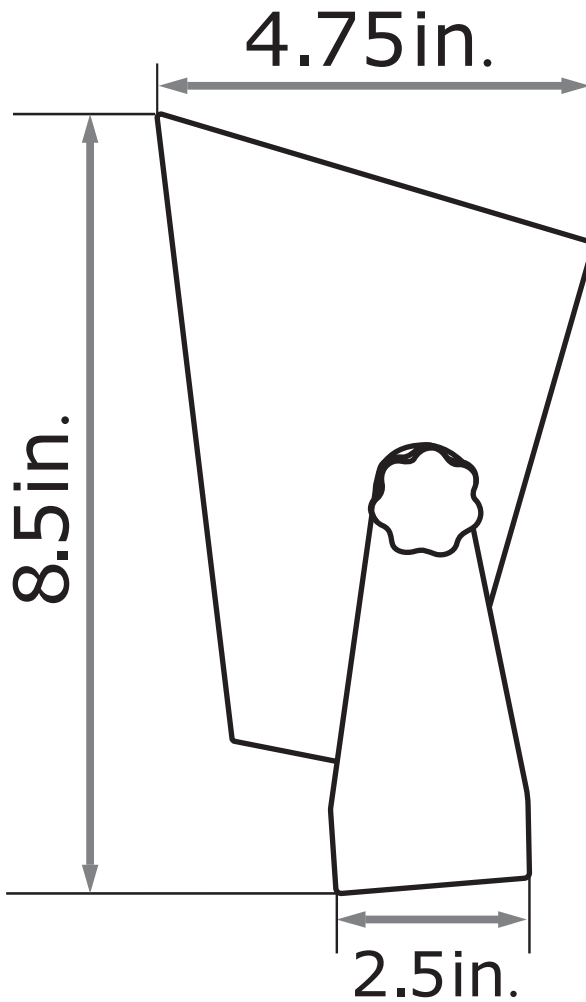
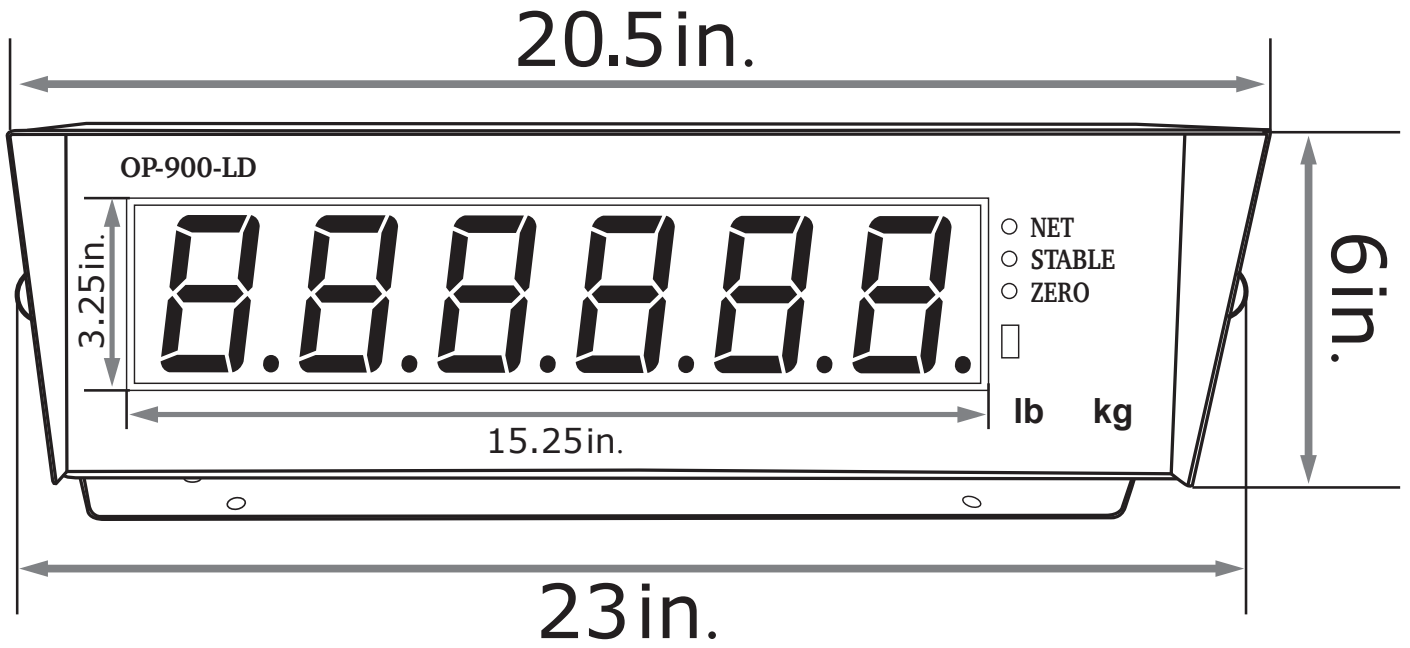

The indicator is powered by an adapter, plug the adapter directly into the AC110V outlet located at the bottom of the indicator. We recommend to plug into a wall outlet to avoid interference with other wirings.

SPECIFICATIONS



FIGURE 1: INDICATOR MEASUREMENTS



REMOTE CONTROL

Button	Key Function	Sign
1	ON/OFF	
2	Total	
3	Unit	
4	Tare	
5	Zero	
6	Enter/Set	

DISPLAY AND KEY DESCRIPTION

Net	Shows you are in Net weight mode (weight without tared weight)
Stable	Shows the weight on the scale is stable
Zero	Shows you have zeroed the scale
lb	The weight is shown in pounds
kg	The weight is shown in kilograms
	Power
	Arrow keys
	Return/Enter

OPERATING INSTRUCTIONS

Power On

- Turn on the power by pressing the power  button **(1)** for 2 seconds. Once on, the scale will begin to auto-check and count down from 0-9 sequentially before entering the weighing mode

Note: Anything on the scale before powering on will automatically be tared out.

Zeroing

- The zero function is used only when the scale is empty and is not at gross zero due to material build up
- Pressing the ZERO button **(5)** will reset your scale to 0
- Depending on what your manual zero range parameter is set to, you can zero out any number within your set selection, after that you will receive an error and will need to tare out the weight

Unit Selection

- To switch between measuring units kg/lb press the UNIT **(3)** button

Tare Function







- The Tare function is used when you only wish to see the current change in weight, not the entire amount of weight that is on the scale
- When the indicator is in gross mode (normal weighing) pressing the TARE button **(4)** will Tare the current weight on the scale and enter the net mode (net light shown)
- For example if you are using a container add the container to the scale, press tare to reset back to 0
- Add your product to the scale to weigh without the weight of the container
- To exit Tare mode press the TARE button **(4)** again to enter gross mode and you will see the total weight of the container and the product

Note: If you remove the container the scale will show the minus weight of the container





















Accumulation

- The accumulation function is used to add multiple weights and total them together
- In weighing mode load the first weight, once stable press the TOTAL button **(2)** to enter the accumulation mode.
- The screen will flash "n000 1" followed by the first weight
- Remove weight so the scale is at 0 before adding the second weight to the scale
- Once stable press the TOTAL button **(2)** to add the second weight to the accumulated total
- The screen will flash "n0002" followed by the second weight
- Continue this process until all the weights you want to accumulate are stored
- When you are ready to see the accumulated weight press and hold the TOTAL button **(2)** and the ENTER button **(6)** at the same time
- The accumulated number "n000#" (the number of weights you are adding together) will flash on the display followed by the total
- The total will display by flashing between 2 sets of numbers
- There are 8 digits in total, the display will flash 4 at a time, the first 4 on the left and the last 4 on the right. For example if the first 4 digits are "0012" and the last 4 digits are "3456" the actual weight is 001234.56 or 1234.56 lbs/kg
- To exit accumulation mode, wait for the last 4 digits on the right of the screen to appear, and then press and hold the TOTAL button **(2)** for one second
- "[Lr n" will be displayed, asking you if you want to keep the data?
 - If NO you do not want to clear the accumulated total, then keep "[Lr n".
 - If YES you do want to clear the accumulated total, then use the arrow button **(4)** to change to "[Lr 4".
- Finally, press the ENTER button **(6)** to select exit accumulation mode and return to back weighing mode







REMOTE CONTROL











Button	Sign	Function
1		ON/OFF
2		Total
3		Unit
4		Tare
5		Zero
6		Enter/Set

CALIBRATION PROCEDURE

1. Turn on the scale by holding ON/OFF  for 2 seconds.
2. Press ON/OFF  and ENTER  together to access the setup menu.
3. If done correctly, the display should now show **[0 1]**.
4. Press ENTER  to access the C1 channel. The display should show **[C 1 #]**.
5. Press ZERO  to choose which unit you want to calibrate in (1 = kg, 2 = lb).
6. Press ENTER  to set the value. The display will now show **[02]**.
7. Press ENTER  to access the C2 channel. The display should show **[C2 #]**.
8. Press ZERO  to change the setting to the decimal places desired (The C2 channel is used to adjust the decimal point on the scale. A value of 1 means there is one digit behind the decimal point.)
9. Press ENTER  to set the value. The display will now show **[03]**.
10. Press ENTER  to access the C3 channel. The display should show **[C3 #]**.
11. Press ZERO  to cycle through the values until the desired graduation appears.
(The C3 channel adjusts the divisions on the scale. A value of 1 selected and C2 set to 1, the scale will read in 0.1 lb. increments.)
12. Press ENTER  to set the value. The display will now show **[04]**.
13. Press ENTER  to access the C4 channel. The display will show **[#####]**.
14. Enter in the maximum capacity you want to use for this scale by using TOTAL  and UNIT  to move the cursor left and right, and TARE  and ZERO  to move the values down and up. (The C4 channel is used to enter in the max capacity of the scale; Make sure this doesn't exceed the max capacity of the scale; Max capacity divided by the increment set in C02 and C03 above cannot exceed 5000.)
15. Press ENTER  to set the value. The display will now show **[05]**.
16. Press ENTER  to access the C5 channel. The display should show **[C5 0]**.
17. The C5 channel calibrates zero on the scale. Make sure the scale is empty.
18. Press ZERO  to change the value to 1.
19. Press ENTER . The display will count down from 10-1 while the scale is calibrating zero. When the display shows 0 the zero calibration is complete.

REMOTE CONTROL

Button	Sign	Function
1		ON/OFF
2		Total
3		Unit
4		Tare
5		Zero
6		Enter/Set

20. Press ENTER  to continue. The display will now show **C06**.
21. Press ENTER  to access the C06 channel. The display will show [**C6 0**].
22. The C6 channel is used to calibrate the scale with a known weight. Press ZERO  to set the value of C6 to [**C6 1**]. Press ENTER . The display will flash **SPAN**, and then show [#####].
23. Enter the calibration weight value you will use (at least 10% of max capacity you set in C04 by using TOTAL  and UNIT  to move the cursor left and right, and TARE  and ZERO  move the values down and up.
24. Place the calibration weight you have on the empty scale and press ENTER .
25. The scale will count down from 10 to 0. Once 0 has been reached, the display will show **CAL End**.
26. Press ENTER  to continue. The display will now show **C07**.
27. Press ON/OFF  quickly to save and exit the setup menu.
28. The scale has now been calibrated. The display will show the value of the calibration weight on the scale.
29. If the scale does not show the value of the calibration weight, check that the feet on the platform are not screwed in too tightly, and verify that the platform is level.
30. Unload the scale; the display should read **000000**.
31. If the scale does not display 000000, check that the feet on the platform are not screwed in too tightly, and verify that the platform is level.

INDICATOR PARAMETER SETTINGS

The parameter settings menu has a calibration section (C01 to C07) and a parameter settings section (C08 and up).

To enter calibration/parameter settings, follow the procedure below:





1. Press and hold the POWER  button **(1)** and the ENTER  button **(6)** at the same time
 2. Navigate through the settings (C01 to C45) as shown in the table 4 below by using the arrow buttons **(2-5)** and the ENTER button **(6)**
 3. Press the 6  button to enter/edit the parameter setting
- Press the 1  button to save and exit settings at any time

Table 1. Indicator Parameter Settings

Function	Parameter	Settings/Options	Default
Weighing Unit	C01	1 = kg 2 = lb	1
Decimal Setting	C02	0 = no decimal 1 = 0.0 2 = 0.00 3 = 0.000 4 = 0.0000	0
Graduation Setting (readability of the least significant digit)	C03	options: 1/2/4/10/20/50 Example with no decimal places (ie. C02=0) 1 = 1 lb 2 = 2 lb 5 = 5 lb 10 = 10 lb 20 = 20 lb 50 = 50 lb	1
Maximum Capacity	C04	set max capacity ex. 100kg = 0100.00	1000
Zero Calibration	C05	0 = zero calibration not needed 1 = set the zero calibration (Please be sure scale is empty and the stable light is on)	0
Calibration	C06	0 = calibration not needed 1 = Ready to calibrate with a calibration weight	0
Restore Default Settings	C07	0 = do not restore 1 = restore to default settings	0
Warning Tone	C08	0 = turn off warning tone 1 = turn on warning tone	1
Automatic Power Off	C09	0 = turn off auto power off 10 = power off automatically if no change within 10 min. 30 = power off automatically if no change within 30 min. 60 = power off automatically if no change within 60 min.	0
Power Saving Mode	C10	LED Version OP900A: 0 = turn off power saving setting 3 = turn off display if no change within 3 minutes 5 = turn off display if no change within 5 minutes	0

Function	Parameter	Settings/Options	Default
Hold Function	C 11	0 = turn off hold function 1 = Peak hold - Grabs the highest weight 2 = Manual hold - Grabs the current weight 3 = Auto hold - Automatically holds data when stable	0
Unit Conversion	C 12	0 = kg/lb convert on 1 = kg/lb convert off	0
Upper Limit Alarm	C 13	Set upper limit within the max. capacity	000000
Lower Limit Alarm	C 14	Set lower limit within the max. capacity	000000
Inner Code Display	C 15	check the inner code (raw data)	
Set Date	C 16	Set date from left to right: year/month/day	
Set Time	C 17	Set the time from left to right: hour/minute/second	
Communication Setting	C 18	Set the serial interface data output method: 0 = Turn off serial interface data output 1 = Continuous sending mode, connect remote display 2 = Print mode, connect printer 3 = Command request mode, connect computer. 4 = PC continuous sending mode, connect computer	0
Baud Rate	C 19	0=1200 (for remote display) 1=2400 2=4800 3=9600	3
Manual Zero Range	C20	0 = turn off manually zero setting 1 = ±1% max capacity 2 = ±2% max capacity 4 = ±4% max capacity 10 = ±10% max capacity 20 = ±20% max capacity 100 = ±100% max capacity	10
Initial Zero Range	C21	0 = no initial zero setting 1 = ±1% max capacity 2 = ±2% max capacity 5 = ±5% max capacity 10 = ±10% max capacity 20 = ±20% max capacity 100 = ±100% max capacity	10
Zero Tracking	C22	0= turn off zero tracking 0.5 = ±0.5d 1.0 = ±1.0d 2.0 = ±2.0d 3.0 = ±3.0d 4.0 = ±4.0d 5.0 = ±5.0d Note: the zero tracking range can not be bigger than manual zero range	.05 d = division
Zero Tracking Time	C23	0 = turn off zero tracking time 1 = 1 second 2 = 2 seconds 3 = 3 seconds	1

Function	Parameter	Settings/Options	Default
Overload Range	C24	00 = turn off overload range 01-99d = overload range setting d = division	9
Negative Display	C25	0 = -9d 10 = -10% max. capacity 20 = -20% max. capacity	10
Standstill Time	C26	0 = quick 1 = medium 2 = slow	1
Standstill Range	C27	1 = 1d 2 = 2d 5 = 5d 10 = 10d d = division	2
Digital Filter (for filtering moving weight such as animals)	C28	0 = turn off dynamic filter 1 = 1 digital filter strength 2 = 2 digital filter strength 3 = 3 digital filter strength 4 = 4 digital filter strength 5 = 5 digital filter strength 6 = 6 digital filter strength Note: The higher the number, the higher the filter strength	0
Noise Filter	C29	0 = turn off noise filter 1 = 1 digital filter strength 2 = 2 digital filter strength 3 = 3 digital filter strength	2
Print Time and Date	C30	0 = yy.mm.dd 1 = mm.dd.yy 2 = dd.mm.yy 3 = yy.mm.dd	

HELPFUL DEFINITIONS

Division: The amount of increments a scale offers. How accurate the scale can be

Capacity: the maximum amount the scale can contain

Initial Zero Range: The percentage of weight allowed on the scale when indicator is powered on that will automatically zero.

example: If initial zero range is set to 10% of the max. capacity and your max. capacity is 100lbs, you can place up to 10lbs of weight on the scale and when the indicator is powered on, it will automatically zero out the weight.

Manual Zero Range: The percentage of weight allowed on the scale where the indicator will let you manually zero (anything above this percent will be tared)

Zero Tracking Range: A subset to the manual zero range; if the weight on the scale is not stable, the zero tracking range still allows you to zero within a set division of the scale

Zero Tracking Time: A subset to the zero tracking range, it is the time allowed for the scale to fall within the zero tracking range tolerance and still qualify to be zero'd

Overload Range: Weight allowance that is out of the set calibrated range. Adds a tolerance to the calibrated max. capacity without having to recalibrate.

example: If your scale has a max. capacity of 1000lbs with a division of 1 and you set the overload range to 60, you can add 1060lbs of weight to the scale without it displaying an error code

Negative Display: How far you can go in the negative direction before displaying an error code

Standstill Time: How fast the scale will stabilize

Standstill Range: How much the scale can fluctuate before being determined stable

Digital Filter: For filtering moving weight, such as animals, It changes how sensitive the scale is to variations in movement.

Noise Filter: A filter for how susceptible the scale is to general variations

Baud Rate: The rate at which information is transferred in a communication channel.

example: In the serial port context, "9600 baud" means that the serial port is capable of transferring a maximum of 9600 bits per second.

CONNECTORS

Connecting load cells to the indicator

- The indicator can connect with 6 load cells of 350Ω at most
- 4 wire or 6 wire load cell connections are both okay
- Please contact us directly if you have other special needs for your application
- There are two connection methods between the load cell and indicator

Quick Disconnect as shown below: Figure 2: Quick Disconnect connection diagram

Figure 2:
Quick Disconnect
connection diagram

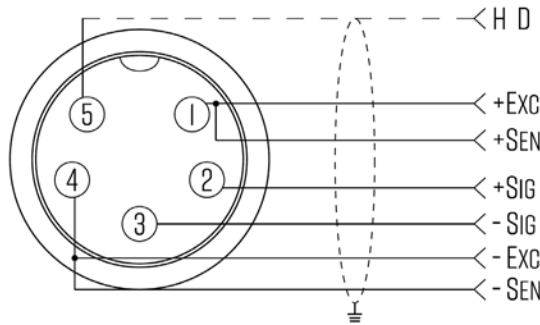

Hardwire (Using Inner Terminal Block Connection:

Note: Make sure you follow all the anti-static rules to avoid damage to your indicator

- Excitation voltage: 5V DC
- Largest output current: 120 mA
- Excitation circuit: 5 VDC, 4 wire connection, 6 load cell of 350ohm maximum
- Open the back cover of the weighing indicator, and insert signal cable to the terminal block (see figure 3); Make sure the screw on terminal block is fixed tightly

FIGURE 3:
INNER TERMINAL BLOCK
CONNECTION DIAGRAM

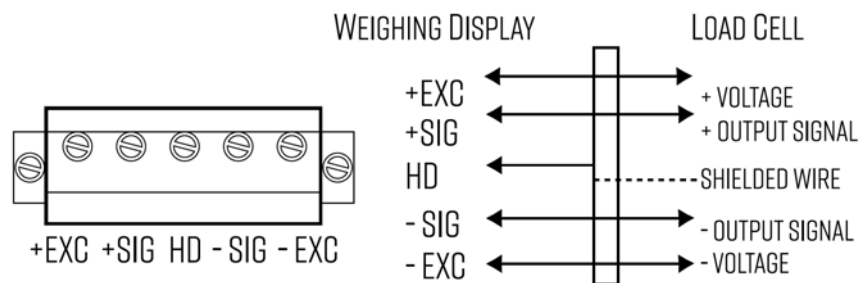

Table 4. Wiring Color Code

Signal Name	Color Code	Description
+Exe/ +EX	RED	Positive excitation voltage to load cell
+IN / +SIG	GREEN	Positive output signal from load cell
HD / SHLD	YELLOW/THICK BLACK	Shield Wire
-IN / -SIG	WHITE	Negative output signal from load cell
-EXC / -EX	BLACK	Negative excitation voltage to load cell

TROUBLESHOOTING

Error Codes

Error	Reason	Solution
UUUUUUU	<ol style="list-style-type: none"> 1. Overload 2. Wrong connection with load cell 3. Load cell has quality problem 	<ol style="list-style-type: none"> 1. Reduce the weight 2. Check load cell connection 3. Inspect load cell; Check the input/output 4. See Q&A section
nnnnnnnn	<ol style="list-style-type: none"> 1. Calibration is no good 2. Wrong connection with load cell 3. Load cell has quality problem 	<ol style="list-style-type: none"> 1. Make sure scale is level 2. Check load cell connection 3. Check load cell input and output resistance 4. See Q&A section
Err 1	During calibration, weight is not used or the weight is above the max. capacity	Use correct weight within the defined range
Err2	During calibration, the weight is below the minimum required weight	The calibration weight minimum is 10% of the max. capacity set in C04. Recommended to use 60%-80% of max. capacity if possible
Err3	During calibration, the input signal is negative	<ol style="list-style-type: none"> 1. Check all wire connections 2. Check load cell 3. Recalibrate 4. PCB replacement needed if steps 1-3 fail
Err4	During calibration signal is unstable	After the platform is stable, start calibration
Err5	EEPROM Error	Change PCB
Err6	Exceed Zero Range	See Q&A section

Q&A

Q:	The scale does not turn on
A:	Make sure the power cord is plugged in, and that there is power. One easy way to test this is by connecting another appliance to the same outlet and see if it's operational
Q:	The reading goes negative when a load is applied
A:	Try interchanging the Sig+ and Sig- wiring connected to the load cell and/or junction box (if one is used)
Q:	How do I resolve ERR6 error?
A:	<p>Please follow the procedure below:</p> <ol style="list-style-type: none">1) Turn on the indicator and make sure nothing is on the scale, and that the scale is level and not wobbling2) Press and hold the "POWER and ENTER" buttons (1+6) simultaneously for 2 seconds3) The screen will read "C01"4) Using the arrow buttons, change C01 to C20. You have to change the 1st digit from 0 to 2 first before you can change the 2nd digit 1 to a 0.5) Press the "ENTER" button to enter C20 parameter6) Change the value of C20 on the right to 100 if using the up arrow key7) Press the "ENTER" button to enter your selection8) The screen will read "C21" now9) Press "ENTER" key to enter C21 parameter10) Change the value on the right of C21 to 100 if available, 20 if not11) Press "ENTER" key to enter your selection12) The screen will read "C22" now13) Press "POWER" key to save and exit14) Power the indicator off and then on, and see if this resolves the ERR 6 issue. If not, then following the Q&A answers below for resolving "nnnnnn" and "uuuuuu" errors
Q:	How do I resolve "nnnnnn" and "uuuuuu" error?
A:	<ol style="list-style-type: none">1) Check to see if the cable that runs from the indicator to the junction box is damaged. If it is, replace the cable.2) Open up the junction box (if available) and check to see if there is any water damage. If so, replace the junction box3) Make sure all the wires on all 5 terminal blocks (5 wires on each terminal block) are not loose. Re-tighten the screws even if the wires seem to be connected4) Recalibrate5) If steps 1-4 do not work, there is a possibility one or more load cells are defective (consult with support@optimascale.com for further instructions)

CONTACT US

Please e-mail info@selletoncales.com for any sales related questions or







call 844-735-5386

Don't forget to visit our website at:







www.selletoncales.com

Below are remote guides to print out

REMOTE CONTROL

Button	Sign	Function
1		ON/OFF
2		Total
3		Unit
4		Tare
5		Zero
6		Enter/Set

REMOTE CONTROL

Button	Sign	Function
1		ON/OFF
2		Total
3		Unit
4		Tare
5		Zero
6		Enter/Set