

K-LINE® Irrigation Farm Packs

3 Pod, 4 Pod and 5 Pod Farm Packs

with 1 1/4" K.PIPE® and Naan 5022 Sprinklers

Installation and User Manual

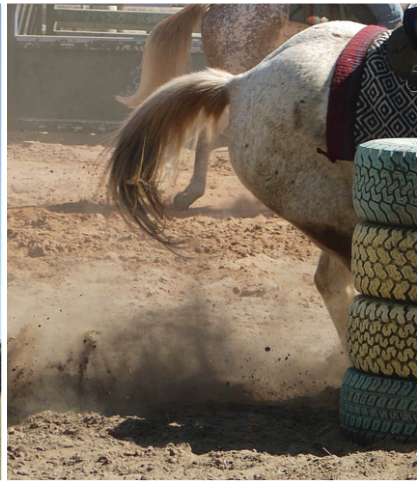





















K-Line Irrigation, North America
Phone: 269-429-3000
Email: info@K-LineNA.com
www.K-LineNA.com

JAN 2023

STEP 1: View the K-LINE® Installation Video

Please review the K-LINE® Installation video found on the *Installation* page of our website at www.K-LineNA.com/installation

STEP 2: Identify System Components

 <p>32mm Tapping Saddle (1) KLTPS32</p>  <p>Sprinkler w/Red Nozzle (1) NAAN-5022-R</p>  <p>Sprinkler Adaptor (1) NAAN-ADAPT</p>  <p>K-LINE® Pod (1) KL-POD-1A</p>  <p>Brass Nuts (2) KLSP-BRASSNUT</p>  <p>Black & Orange Nozzles* (1 each) NAAN-NOZ-BK NAAN-NOZ-O</p> <p><small>*Alternative nozzles for sprinkler</small></p>	 <p>3 Pod Pack 32mm K.PIPE® x 216 ft. KL32LD</p> <p>or</p>  <p>4 Pod Pack 32mm K.PIPE® x 250 ft. KL32LD</p> <p>or</p>  <p>5 Pod Pack 32mm K.PIPE® x 377 ft. KL32LD</p> <p>or</p>  <p>Farm Pack Extension 40mm K.PIPE® x 328 ft. KL40LD</p>	 <p>Male Camlock w/ female threaded end (1) KUR-12A</p>  <p>Female Camlock w/ female threaded end (1) KUR-12D</p>  <p>1 1/4" Hex Nipple (1) RXHN32</p>  <p>Tow Cap (1) RXTC32</p>  <p>Male Coupling (3) KLMC32</p>  <p>Straight Coupling (1) KLSC32</p>  <p>Rope 6.5 ft. (1) SHIFTR-ROPE</p>  <p>PTFE Thread tape (1) CT</p>  <p>13mm metric deep socket x 3/8" (1) KLTL.3.8.13SOCKET</p>  <p>14mm Spade bit w/limiter (1) KL/BIT</p>  <p>Drill head Adaptor 3/8" drive x drill head (1) KLTL.DRILL.ADAP</p>
--	---	--

(3 Pod pack = 3 x value shown)











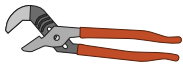

(4 Pod pack = 4 x value shown)

(5 Pod or Farm Pack = 5 x value shown)

(select pipe from your pack)

(standard components in each pack)

STEP 3: Tools That May Assist With Installation

 <p>Adjustable pipe wrench</p>	 <p>Large channel lock pliers</p>	 <p>Rubber mallet</p>	 <p>3/8" Ratchet wrench</p>	 <p>Socket extension 3/8" x 6"</p>	 <p>Tie-down hook & rope (optional)</p>	
 <p>Cordless drill</p>	 <p>1 1/4" to 2" poly pipe cutters (or hacksaw)</p>	 <p>Water</p>	 <p>Measuring wheel or 200 ft. tape(s)</p>	 <p>Marker flags or tent pegs</p>	 <p>20mm wrench (optional)</p>	 <p>30mm wrench (optional)</p>

STEP 4: K-LINE® System Overview

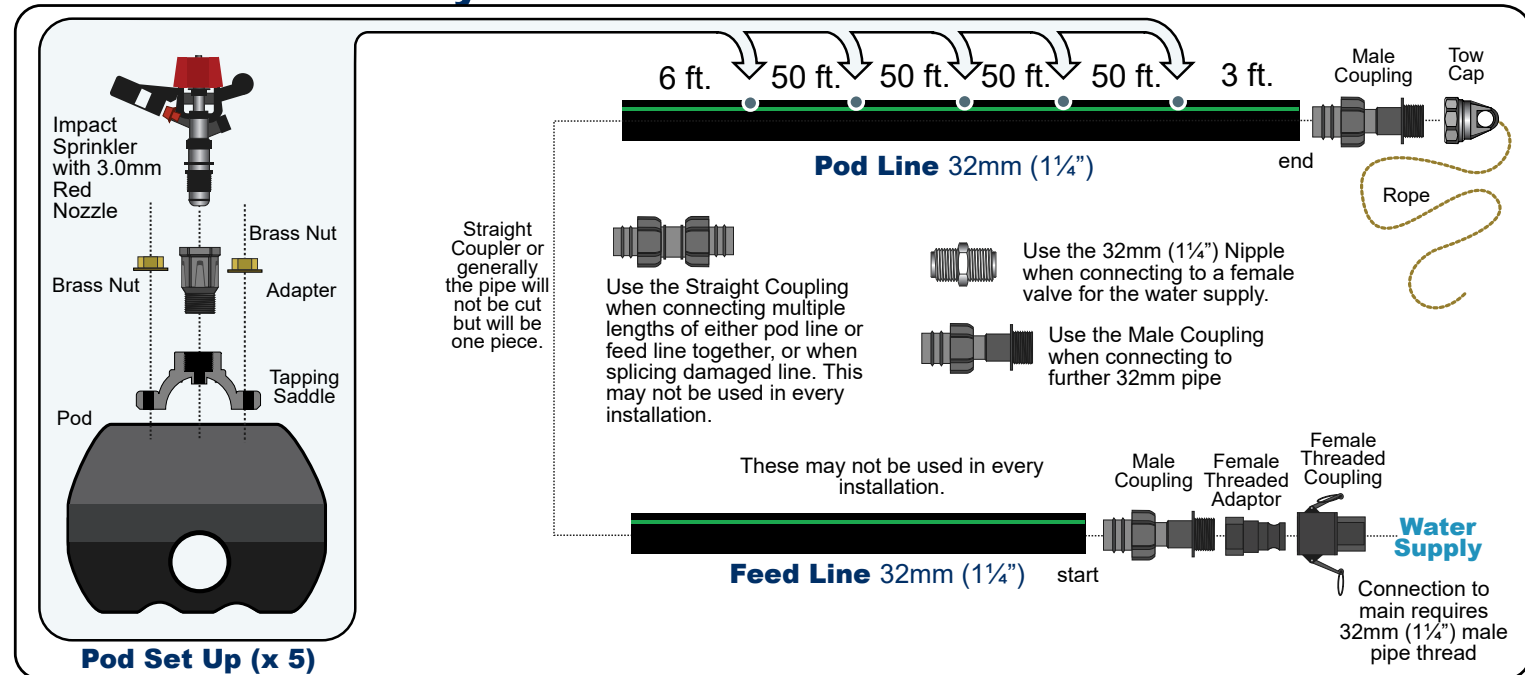

STEP 5: Plan your Irrigation System Layout *

Field shapes and dimensions may not match this ideal layout. K-LINE's signature flexibility allows for adaptation to other field dimensions. See the additional "Sample Designs" on our website.

A

Determine the area of the field to be irrigated.
Up to approx. 2.5 acres.

B

Determine the center of the field. This is the location of the riser.

C

Determine the supply line route from the water supply to the center of the field. The water supply line should be 32mm (1¼") or larger from the water source, beginning at a point where sufficient flow rate and pressure are available.

Water Supply
11 - 23 gallons per minute
@ 35 - 50 psi
Varies depending on nozzle size

D

Consider your supply line. Supply line options include:

1. Buried (underground) PVC or polyethylene plastic pipe.
2. Lay-flat tubing (above ground), similar to fire hose, available from your irrigation dealer.
3. K.PIPE® Irrigation tubing (above ground). K.PIPE® is highly durable and specifically formulated to remain flexible, is freeze resistant, and has excellent UV resistance.

E

Determine Shift/Set Widths.
Shift/Set widths are recommended to be between 40 ft. and 50 ft.

The material included in a 5 pod kit, in most situations, permits for a field length of up to 500 ft. (considering an eight day rotation as depicted here).

K-LINE's great flexibility of design allows for numerous options in laying out a field. K-LINE® is adaptable in its ability to have more than one riser location. Sprinkler/pod lines can be curved to adjust to field shapes, obstacles, or terrain. Sprinkler nozzles are easily changed for adjusting application rates. Shifting more than once per day allows a larger area to be covered quickly. Extended irrigation sets can apply that long, slow rain that fills the soil profile and encourages a stronger, deeper and more efficient, and resilient, root system.

We have included many examples in our "Sample Designs" that can be found on our website to help identify irrigation opportunities for your situation. Call your K-LINE® supplier for any questions.

F

Once a field design has been decided and the riser location(s) have been located, another consideration is the placement of markers at the ends of the area to be irrigated to aid in shifting the K-LINE®.

Placement of markers at the end of the field (in the center of each Set width – see the Diagram to the right) gives the operator a target to aim for when shifting the K-LINE® (especially beneficial when becoming accustomed to shifting the K-LINE® or in irregularly shaped fields).

Markers are often brightly colored (fluorescent yellow, orange, or red) markers that can be attached to a fence; that offer excellent visibility.

STEP 6: K-LINE® Irrigation Layout of the Pod Line

A Rolling out the Pod Line

Roll out the 32mm tubing 10-15 ft. past the final marker to keep the end from rolling back during pod installation.



DO NOT ALLOW IT TO TWIST! The green line(s) should face up for the entire length of the tubing.

***Hint:** It helps to put a heavy object on the ends of the K-LINE® Tubing when rolling it out to keep the tubing in place and prevent it from rolling up behind you. The tubing will relax once rolled out and allowed to sit in the sun.

B Measuring pod placement

Using the measuring wheel or tape, mark out the pod positions with flags or tent pegs and confirm the pod positions.



Note: Sprinkler/pod spacing is determined by field length and may differ if your area to be irrigated is less than 500 ft., (5 pod pack). For your K-LINE® Pod Irrigation Kit, recommended spacing up to, but not more than 50 ft. Dealer engineered K-LINE® layouts are usually between 40 ft. and 50 ft.

If you need assistance, call your supplier or contact K-Line Irrigation at info@K-LineNA.com

STEP 7: Placing the pods

A Slide the pods onto the K-Line® tubing.

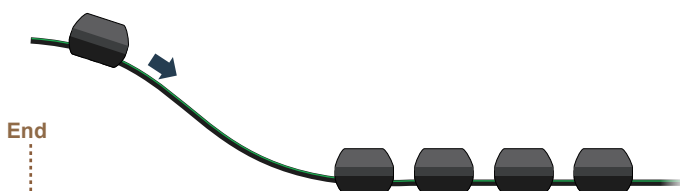

B Use the Tow Rope and Hook to pull all of the pods to the first marker. Unhook a pod, leaving it at the marker.

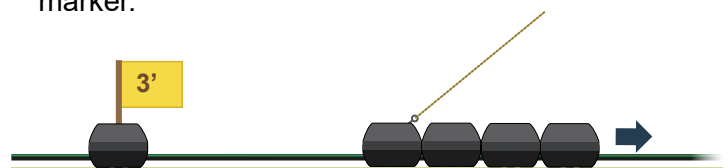

C Continue on to the remaining markers, leaving a pod at each.

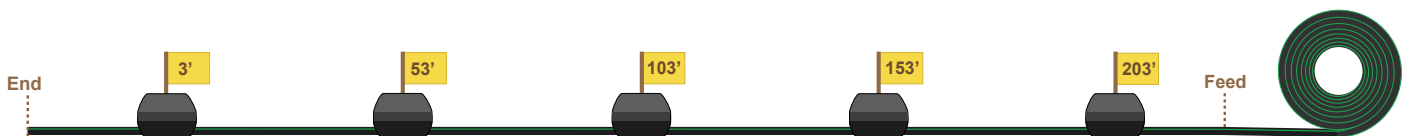

STEP 8: Tapping Saddle Installation

A Install the included K-LINE® spade drill bit w/limiter into a cordless drill.

B The hole to be drilled should be on the center green line in the tubing.

C Drill a 14mm hole in the tubing at the desired spacing.

D **Caution: Do not use a 3rd party drill bit.** The K-LINE® Bit has a limiter attached to it to prevent the bit from being inserted too deeply and puncturing the opposite tubing wall.

After drilling, remove the tubing chaff from each hole.

E Center the pod and the two stainless steel threaded posts with the 14mm hole.

F Make sure that the rubber O-ring is in the groove on the underside of the K-LINE® Tapping Saddle.

G Push the K-LINE® tapping saddle down over the threaded posts and be certain that the nipple on the underside of the tapping saddle is inserted into the 14mm hole.

The K-LINE® tapping saddle should sit snugly over the tubing without a gap.

A gap might indicate that you are pinching the tubing on either side of the hole causing water to spray out into the pod during operation.



STEP 8: Tapping Saddle Installation (continued)

H Hand tighten a 8mm brass flange nut onto each post.

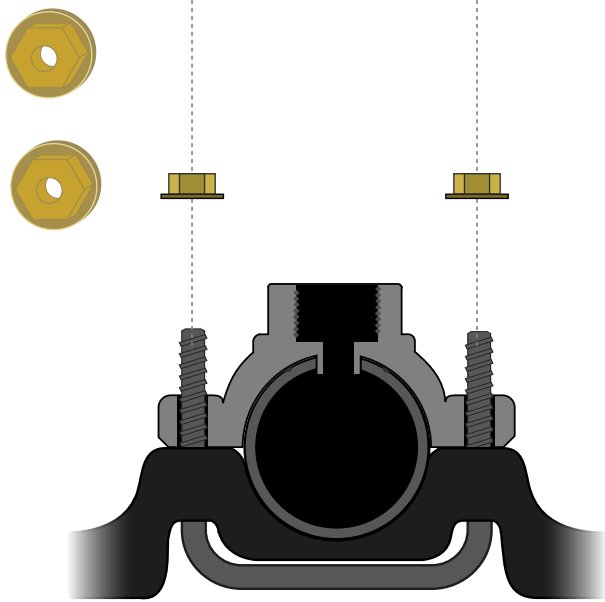

I With a 13mm socket (with 6 inch or longer extension) and ratchet or speed brace alternate tightening the 8mm nuts by switching back and forth several times to make sure that the Tapping Saddle is set level and square.

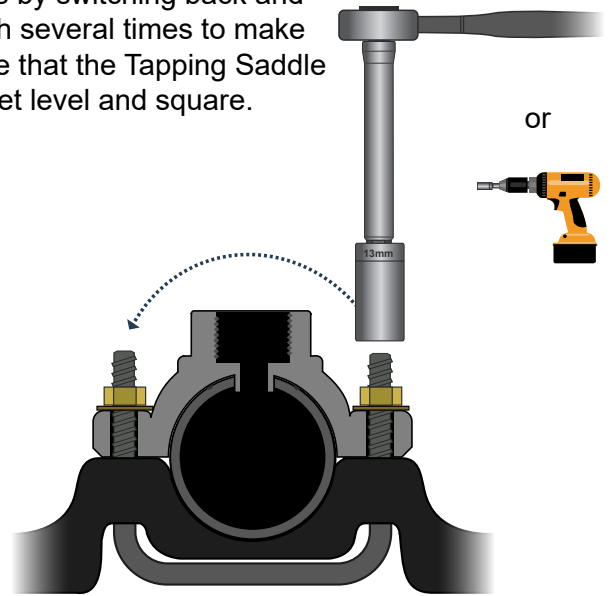

STEP 9: Impact Sprinkler Installation

A Hand start the adaptor into the K-LINE® tapping saddle (careful not to cross thread), then finish tightening with an adjustable wrench or channel lock pliers.

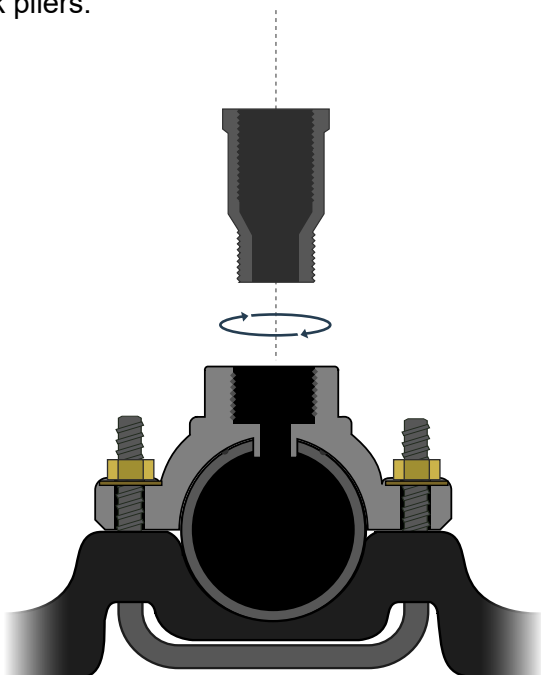

B Hand start the impact sprinkler (careful not to cross thread), then finish tightening with a 20mm open ended wrench or channel lock pliers.

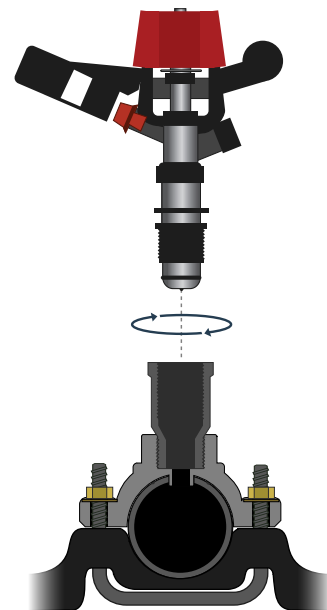

Repeat Steps 8 and 9 for each pod in the line.

STEP 10: K-LINE® Fittings Installation onto the Lines

A

Attach the Male Coupling and Tow Cap to the end of the **Pod Line**, as follows:

① Assemble the Male Coupling and Tow Cap together, and tighten with a pipe wrench and channel locks.*

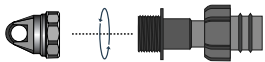

② Moisten the barbed end of the Male Coupling with water. Drive the Male Coupling and Tow Cap into the K.PIPE® Tubing with a rubber mallet ensuring that the collar is back against the neck of the Male Coupling.

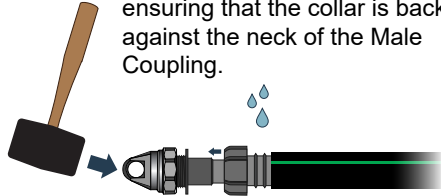

③ Hand tighten the collar of the Male Coupling onto the tubing, then finish by using a combination of pipe wrenches and channel locks to securely tighten the collar. This causes the barbs to bite into the interior and exterior of the K.PIPE® tubing for a strong connection.

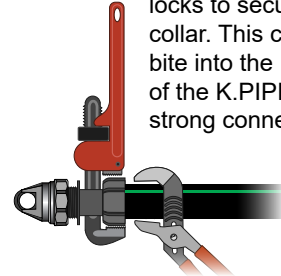

B

Roll out the remainder of the 32mm tubing, this will be the **Feed Line**. In a 5 pod system the **Feed Line** should be approximately 115 ft. if your area to be irrigated is 200 ft. wide (a little more than 1/2 the width). If your area to be irrigated is less than 200 ft., then the **Feed Line** should be at least long enough to run from the riser in the center of the field to the edge of the field.

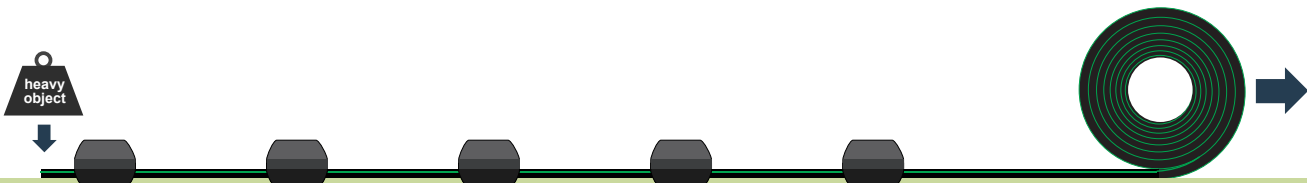

C

Attach the Male Coupling and Female Threaded Adaptor to the Start of the **Feed Line**, as follows:

① Assemble the Male Coupling and Tow cap together, using thread tape on the threads to seal the connection, and tighten with a pipe wrench and channel locks.

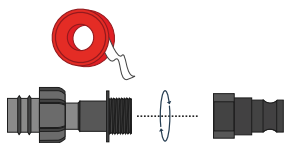

② Moisten the barbed end of the Male Coupling with water. Drive the Male Coupling and Tow cap into the K.PIPE® Tubing with a rubber mallet ensuring that the collar is back against the neck of the Male Coupling.

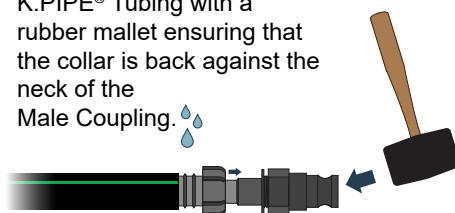

③ Hand tighten the collar of the Male Coupler onto the tubing, then finish by using a combination of pipe wrenches and channel locks to securely tighten the collar. This causes the barbs to bite into the interior and exterior of the K.PIPE® tubing for a strong connection.

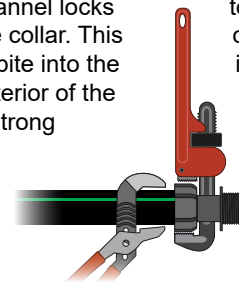

D

Attach the Camlock Female Threaded Adaptor to the Water Supply Line using the supplied Camlock Female Threaded Coupling.

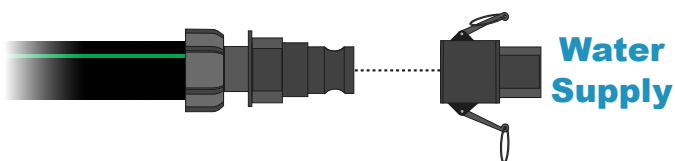

This completes the K-LINE® installation.

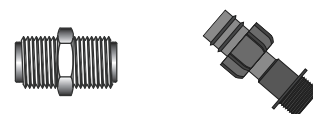

Also supplied is a 32mm nipple and 32mm male coupling to assist with connection to your water supply.

Shifting from Set 1 to Set 2

You can shift K-LINE® Irrigation with an ATV, UTV, ORV, heavy duty lawn tractor, golf cart, or similar tow vehicle. The preferred method of movement is while the sprinklers are in operation. This saves shifting time and the water pressure in the K.PIPE® tubing helps prevent kinking.

The two most important practices to follow when shifting:

1. **ALWAYS Shift on the "dry" side.** Always begin the shifting procedure on the dry (unirrigated) side of the K-LINE®. The "dry" (unirrigated) side of a K-LINE® is the side next to the section(s) of the field that have not been irrigated. This is opposed to the "wet" (irrigated) sections or "Sets" which have been irrigated previously. This will prevent "double loops" in the Feed Line and reduce chances that the tubing will get kinked. Please refer to the illustrations below and note that the "wet" (irrigated) and "dry" (unirrigated) Sets have been labeled.

2. **When connecting to the K-LINE®** always face towards mid-field and position the tow vehicle 6 - 8 ft. from, and parallel to, the K-LINE®.

Step 1 (Set 1)	Step 2	Step 3	Step 4	Step 5	Step 6 (Set 2)
Facing the far end of the field, position your vehicle along side and 6-8 ft. away from the sprinkler/pod line.	Attach the hook and rope at the end of the sprinkler/pod line to the tow vehicle.	Drive along (parallel to) your sprinkler/pod line, staying within 6 - 8 ft. of the line.	As you approach the midpoint of your field (running over the feed line), line up with your marker at the end of the field.	Continue to the end of the field and stop when the first pod is approximately 25 ft. from the end of the field.	Unhook the sprinkler/pod line from your tow vehicle.

Shifting from Set 2 to Set 3

The following steps show how to move the K-LINE® 50 ft. over to the right for the next set.

Step 1 (Set 2)	Step 2	Step 3	Step 4	Step 5	Step 6 (Set 3)
Position your vehicle as described above and hook the sprinkler/pod line to the tow vehicle.	Pull straight forward until you reach the third pod.	Veer right about 50 ft. and straighten to align the vehicle with the end of the field.	Before reaching the center line, veer back slightly to the left and line up with the marker at the end of the field.	Pass over the feed line and continue to the end of the field.	Unhook the vehicle from the sprinkler/pod line.

Follow the steps above to shift the line to irrigate all the sections of the field.

Example of a Complete Shifting Schedule

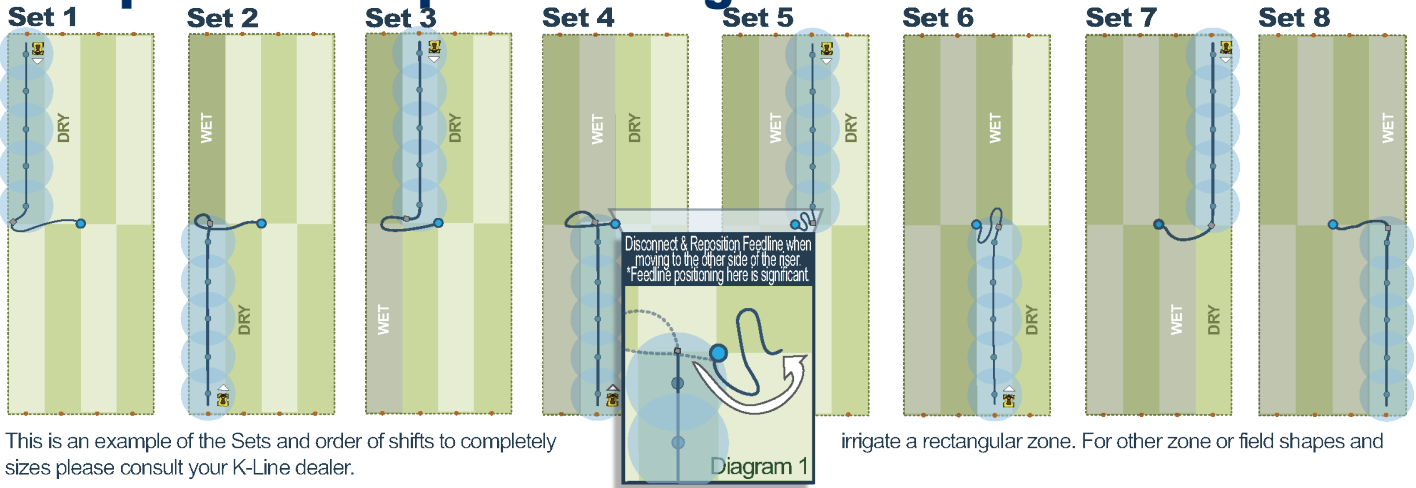

This is an example of the Sets and order of shifts to completely irrigate a rectangular zone. For other zone or field shapes and sizes please consult your K-Line dealer.

Repositioning the Feed Line

You will need to reposition the Feed Line at least once (sometimes more often) as you shift from Set to Set. In this Shifting Schedule, after the 4th shift, where the K-LINE® is positioned to irrigate Set 5, the operator must manually disconnect the Feed Line and reposition the Feed Line as shown in **Diagram 1**. The operator must then reconnect the Feed Line to the Pod Line once the Pod Line is in the Set 5 position.

The operator may also need to reposition the Feed Line if they see that the first sprinkler/pod (closest to the riser or mid-field) is out of alignment with the other pods.

In this Shifting Schedule, this is most likely to occur after shifting the K-LINE® to the Set 7 position. In this situation, just pull the Feed Line (near the cam lock connection) to reposition the sprinkler/pod and Feed Line. Once the operator becomes familiar with the shifting procedure, the need to reposition (as in Set 7) will be less often.

K-LINE® Shifting Hints

To keep the final sprinkler (pod closest to the tow vehicle during shifting) from spraying the operator during shifting, use a clothes pin to prevent sprinkler movement, or a coffee can (or rag) over the sprinkler to redirect the spray. Remove after the K-LINE® has been shifted.

Always position the tow vehicle 6 - 8 ft. from the K-LINE® to be shifted on the dry (unirrigated) side of the K-LINE® - SEE page 8-9. This will prevent "double loops" in the Feed Line and reduce chances that the tubing will get kinked. Mark the ends of the field with large different colored markers or flags to help position your lines properly

The first sprinkler/pod may be out of line with the rest of the sprinklers/pods if you have not positioned the last pod (the sprinkler/pod furthest from mid-field) approximately 25 ft. from the edge of the field; OR if the Feed Line needs to be repositioned (as after moving the K-LINE® to the Sets 5 or 7 positions – see above, Repositioning the Feed Line, for more details).

Shifting K-LINE® in hot weather without water running through the tubing increases the chance of kinking. EITHER shift the line while irrigating, OR shift (without water running) in the early morning or early evening when the tubing is cool.

End of Season

Unhook the Feed Line and K-LINE® from the riser and shift it to the side of the field for storage or during harvest. Setting the K-LINE® on an incline, and the action of shifting the K-LINE® itself, will remove most of the water from the K-LINE®. K.PIPE® tubing will also stretch slightly to withstand some freezing. Open all riser and drain valves to drain the system and cover any open risers or tubing ends (cam dust caps and plugs are available) to prevent small animals from nesting inside.

If a significant amount of grass is allowed to grow up and entangle the K-LINE® (i.e., from autumn through to late spring when you begin irrigating again) then be sure to manually loosen the pods from the grip of the weeds before shifting the K-LINE®.

Resetting the System from Set 8 to Set 1

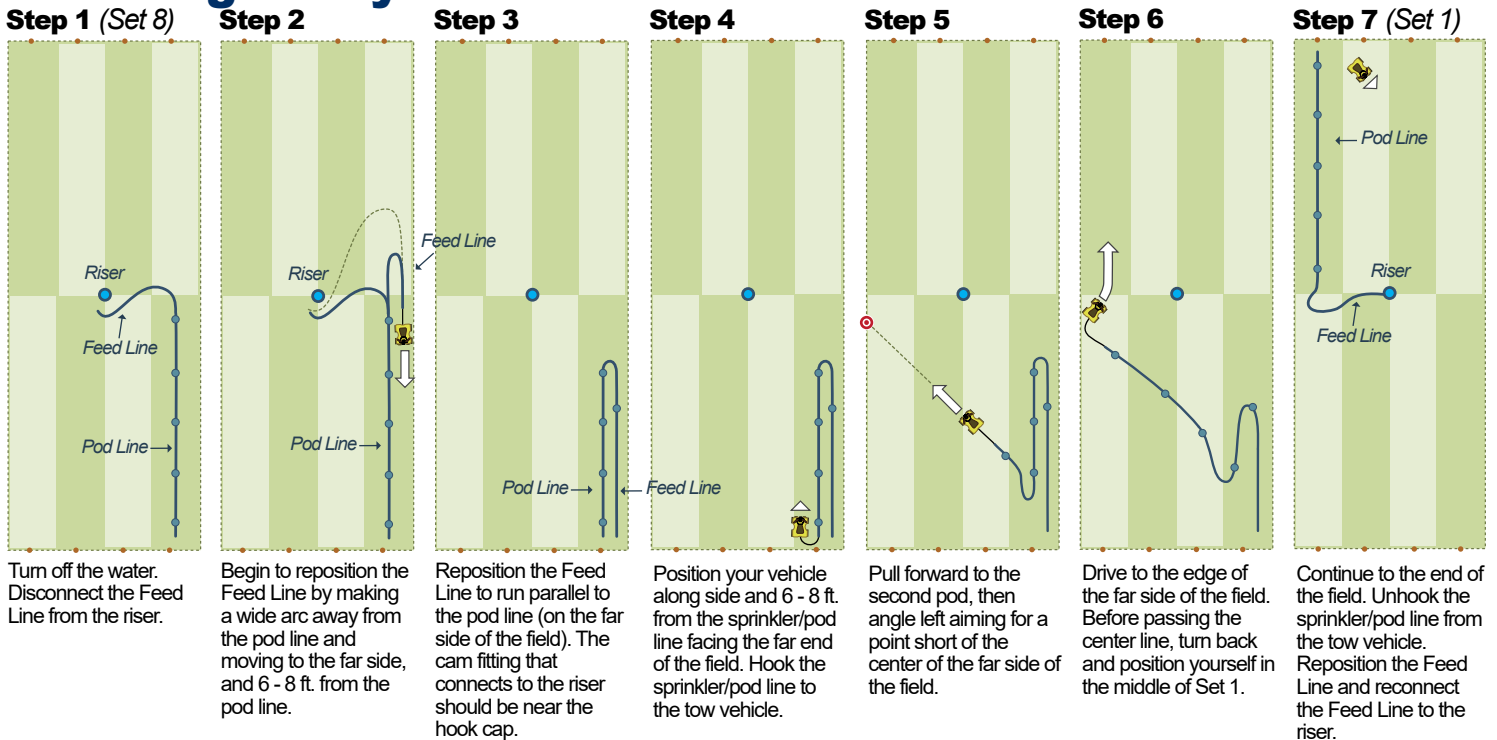

Turn off the water. Disconnect the Feed Line from the riser.

Begin to reposition the Feed Line by making a wide arc away from the pod line and moving to the far side, and 6 - 8 ft. from the pod line.

Reposition the Feed Line to run parallel to the pod line (on the far side of the field). The cam fitting that connects to the riser should be near the hook cap.

Position your vehicle along side and 6 - 8 ft. from the sprinkler/pod line facing the far end of the field. Hook the sprinkler/pod line to the tow vehicle.

Pull forward to the second pod, then angle left aiming for a point short of the center of the far side of the field.

Drive to the edge of the far side of the field. Before passing the center line, turn back and position yourself in the middle of Set 1.

Continue to the end of the field. Unhook the sprinkler/pod line from the tow vehicle. Reposition the Feed Line and reconnect the Feed Line to the riser.

Combining 2 K-Line Kits: Steps 5 through 7

STEP 5: Plan your 10 Pod / 4.4 Acre System Layout

Field shapes and dimensions may not match this ideal layout. K-Line's signature flexibility allows for adaptation to other field dimensions. See the additional "Sample Designs" diagrams found on our website.

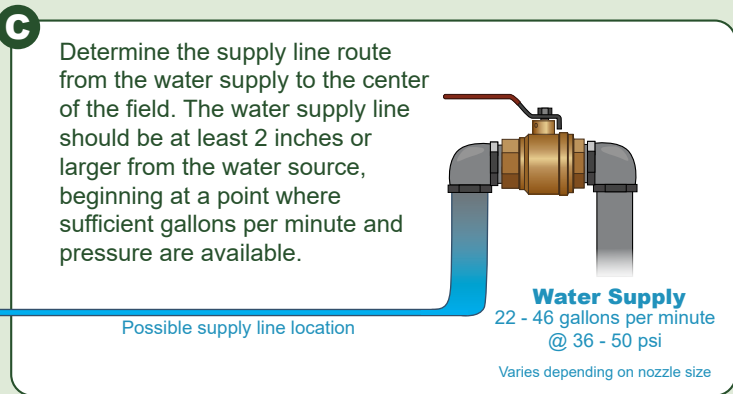
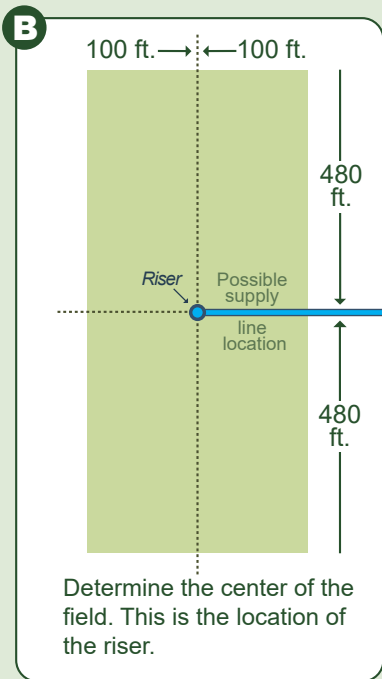
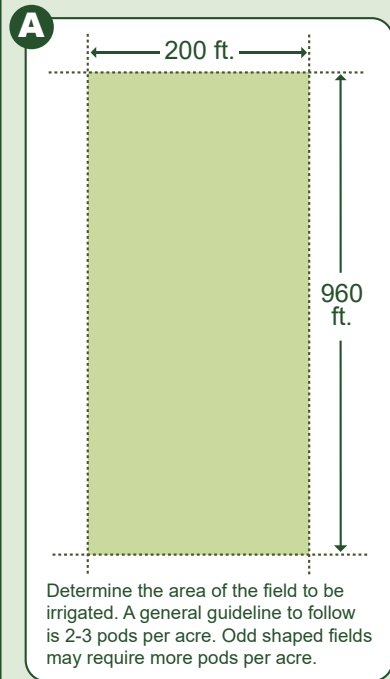

- D**
- Consider your supply line. Supply line options include:
1. Buried (underground) PVC or polyethylene plastic pipe.
 2. Lay-flat tubing (above ground), similar to fire hose, available from your irrigation dealer.
 3. K-Pipe Irrigation tubing (above ground). K-Pipe is highly durable and specifically formulated to remain flexible, is freeze resistant, and has excellent UV resistance.

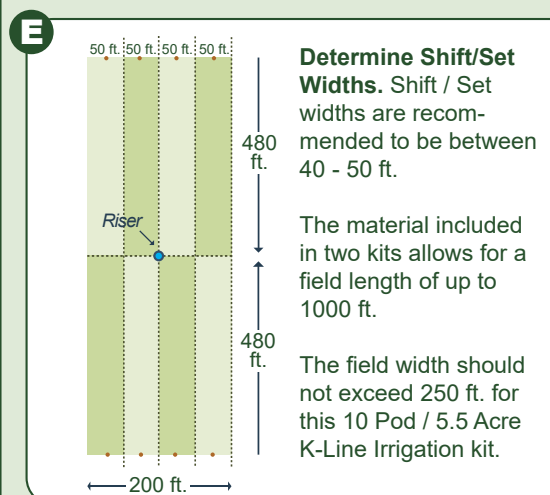

K-Line's adaptability is increased when 2 kits are combined. The example layout in this manual allows 2 Kits to be combined to irrigate a 4.4 acre area, but K-Line's almost limitless flexibility allows you an even greater range of options – from irrigating larger areas with a single 10 sprinkler/pod K-Line, to making two K-Lines of different lengths to irrigate several different sized areas.

The key to K-Line's success is the maneuverability of the sprinkler/pod line, allowing the K-Line to irrigate areas with trees, buildings, ponds, streams, and hilly or irregular shapes to become productive and profitable grasslands. Shifting markers (discussed further on Page 3, Step 5F) allow the operator to become accustomed to shifting and placement of the K-Line from Set to Set.

Follow the "**K-Line Layout Design Process**" on page 11, **Step 6B** to better understand how to develop K-Line layouts for your irrigation opportunities. Our "**Sample Designs**" literature, found on our website, gives many example layouts that may help you identify irrigation opportunities of your own. Call your dealer or K-Line North America at info@K-LineNA.com with any questions.

STEP 6: 10 Pod / 5.5 Acre Layout of the Pod Line

A Measuring pod placement and rolling out the Pod Line

Roll out a measuring tape and place 10 markers/flags, starting at 3 feet then at 50 ft. intervals. Roll out 1 full 40mm roll of tubing for approximately 328 ft. (if the end is kinked, follow the instructions on page 7, step 10E to cut a square end). Continue the line by rolling out the next roll of tubing 20 - 30 ft. past the final marker to keep the end from rolling back during pod installation.

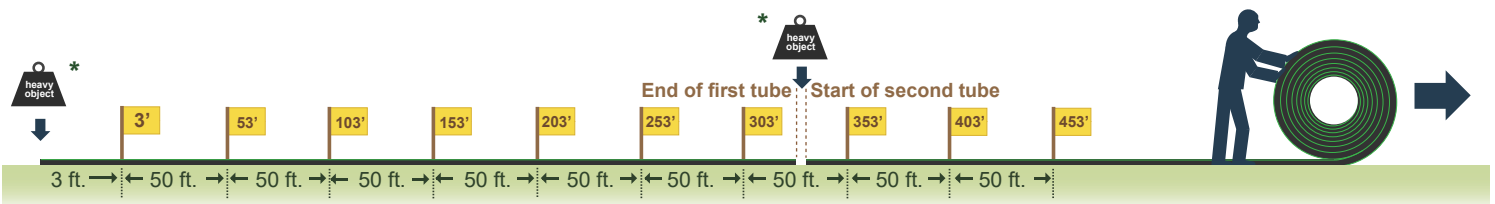

DO NOT ALLOW IT TO TWIST! The green line(s) should face up for the entire length of the tubing. Do not make the end cut until the pods have all been installed.

*Hint: It helps to put a heavy object on the ends of the K-Line Tubing when rolling it out to keep the tubing in place and prevent it from rolling up behind you. The tubing will relax once rolled out and allowed to sit in the sun.

STEP 6: 10 Pod / 5.5 Acre Layout of the Pod Line (continued)

B K-Line Layout Design Process

K-Line recognizes that most areas to be irrigated will differ from the 200 ft. by 1000 ft. dimensions used in this Layout illustration. The process represented in this Installation Manual will guide you through your own application.

In general, you will have 3 ft. of tubing past the final pod, an even spacing between the pods in the line, and prior to the first pod approximately 6 ft. to the feed-line.

Using our sample layout dimensions of 1000 ft. long by 300 ft. wide, you will GENERALLY use these steps, when determining the distance between the pods:

1. Take the length of the field and divide by 2 ($960 \text{ ft} / 2 = 480 \text{ ft}$.)
2. Divide the length by 50 ft. ($480 \text{ ft} / 50 \text{ ft} = 9.6$), always round up ($9.6 \rightarrow 10$), this is the number of pods that you need to use in your K-Line (10 pods).

3. Take the length found in step 1 (480 ft.) and divide by the number of pods that you calculated in step 2 (10 pods) to get the spacing between pods ($480 \text{ ft} / 10 \text{ pods} = 48 \text{ ft. between pods}$).

NOTE: Try not to exceed a 50 ft. spacing between pods.

4. The length of tubing from the first pod of the Pod Line and the beginning of the K-Line feed line tubing should be approximately 2 metres.

This is how we designed this 10 Pod / 4.4 acre layout and you can use this process to develop your own Layout.

NOTE: You will need a length of K-Line tubing for a Feed Line that is $\frac{1}{2}$ (or more) the width (200 ft.) of the area to be irrigated ($200 \text{ ft.} \times \frac{1}{2} = 100 \text{ ft. minimum Feed Line}$).

If you have ANY questions, please contact your K-Line supplier, or contact K-Line North America at info@K-LineNA.com.

STEP 7: Placing the pods

- A** At the break between the two rolls of tubing, slide the 10 pods onto the K-Line tubing. 7 pods on the side with 328 ft. of tubing, 3 pods on the other section of tubing.



- D** Wet and insert the unattached end of the Straight Coupling into the other section of tubing and place your foot (and weight) on the tubing to hold the tubing in place. On the already connected Straight Coupling/tubing side, place the channel locks directly behind the attached collar. Use a rubber mallet to strike the channel locks to drive the Straight Coupling securely into the unattached tubing.



- E** Hand tighten the collar of the Straight Coupling onto the tubing, then finish by using a combination of pipe wrenches and channel locks to securely tighten the collar. This causes the barbs to bite into the interior and exterior of the K-Line tubing for a strong connection.

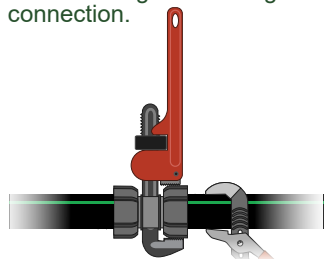

When connecting 2 lengths of tubing, be sure to keep the green lines on the tubing facing up.

- B** Be sure that the tubing ends are square. Moisten the end of the Straight Coupling with water and drive the Straight Coupling into the K-Line Tubing with a rubber mallet.



The "extra set" of Camlocks from combining 2 K-Line Kits can be used in place of a Straight Coupling. See step 10A on page 7 for installation of both Camlocks.

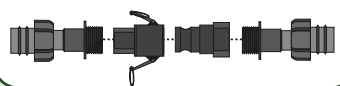

- C** Hand tighten the collar of the Straight Coupling onto the tubing, then finish by using a combination of pipe wrenches and channel locks to securely tighten the collar. This causes the barbs to bite into the interior and exterior of the K-Line tubing for a strong connection.

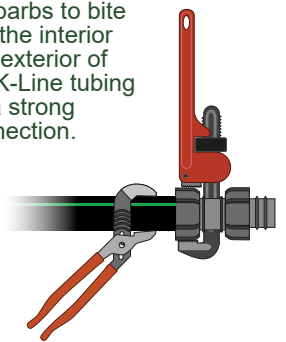

- F** Use the Tow Rope and Hook to pull all pods to the first marker in both directions. Unhook a pod, leaving it at the marker.

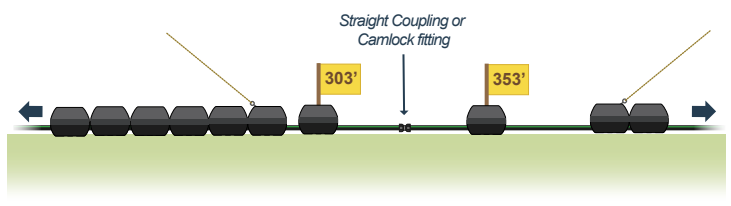

- G** Continue on to the remaining markers, leaving a pod at each.

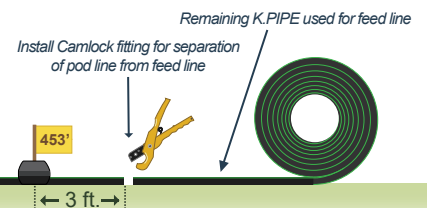





Use $1\frac{1}{2}$ " or 2" Poly Pipe cutters or a Hacksaw to make a square cut at the end of the Pod Line 3 - 5 ft. past the final marker. Make sure that the cut end is square and that any burrs are removed. **RESUME INSTRUCTIONS ON PAGE 5, STEP 8.**

K-LINE® Troubleshooting Guide

Symptom	Possible Cause / Solution
Partial or poor distribution from sprinkler	<ul style="list-style-type: none"> plugged nozzle - remove nozzle, check for obstruction. obstruction in tubing - remove hook cap and flush line improper pump pressure - check pump damaged tubing leaking water - make square cuts to remove the damage, install Straight Coupling. saddle improperly mounted on tubing - remove and mount according to pages 5 and 6, STEP 8
Pods rolling over during shifting	<ul style="list-style-type: none"> towing vehicle is too far from K-LINE® - keep less than 8 ft. from the pod line while shifting
Connectors coming loose	<ul style="list-style-type: none"> improper tightening of the K-LINE® connectors - cut off and discard 3 inches of old scarred tubing when repairing (make sure that you have a square cut), then use pipe wrenches to more firmly tighten the connectors - see page 7, STEP 10A. If this fails, replace fitting with new fitting with sharp edges.
Water Stream hits the inside of the pod	<ul style="list-style-type: none"> tapping saddle is improperly tightened down - reposition tapping saddle and tighten down evenly, see pages 5 and 6, STEP 8
Feed Line loop gets too tight	<ul style="list-style-type: none"> Feed Line needs to be repositioned - see page 8, "Repositioning the Feed Line" Feed Line is too short - add more tubing or narrow the width of the irrigated area
K.PIPE® tubing gets kinked	<ul style="list-style-type: none"> failure to reposition Feed Line – see page 9, "Repositioning the Feed Line" - shifting the K-LINE® without water running when temperatures are hot - -straighten the kinked K.PIPE® tubing and use a rubber mallet to lightly pound the tubing back into shape

Performance Chart

Impact sprinkler nozzle options. Performance based on 50 ft. between sprinklers and a 50 ft. shift width. Sprinkler or shift spacings closer than 50 ft. will result in higher application rates.

Nozzle Color & Size	Operating Pressure	Output per Sprinkler (gal. per min.)	Total Water Required for 5 Sprinklers (gal. per min.)	Water Application Rate (inches / hour)	Total Applied Water in 24 hr. Set	Average Application Rate Per Week <small>Based on 8 Shifts with Continuous Running</small>
 Orange - 2.8mm	35 psi	2.20	11.00	0.075	1.80 in.	1.58 in.
	40 psi	2.30	11.5	0.079	1.90 in.	1.66 in.
	45 psi	2.42	12.10	0.083	2.00 in.	1.75 in.
 Red - 3.0mm	35 psi	2.54	12.70	0.087	2.09 in.	1.83 in.
	40 psi	2.63	13.15	0.091	2.18 in.	1.90 in.
	45 psi	2.77	13.85	0.094	2.26 in.	1.98 in.
 Black - 4.0mm	35 psi	4.24	21.20	0.146	3.50 in.	3.06 in.
	40 psi	4.39	21.95	0.150	3.60 in.	3.15 in.
	45 psi	4.61	23.05	0.157	3.77 in.	3.30 in.
The green and blue nozzles below are optional sprinkler nozzles available from a K-LINE® Dealer						
 Green - 3.2mm	35 psi	2.83	14.15	0.098	2.35 in.	2.06 in.
	40 psi	2.90	14.50	0.100	2.40 in.	2.10 in.
	45 psi	3.10	15.50	0.110	2.64 in.	2.31 in.
 Blue - 3.5mm	35 psi	3.27	16.35	0.110	2.64 in.	2.31 in.
	40 psi	3.39	16.95	0.118	2.83 in.	2.48 in.
	45 psi	3.58	17.90	0.122	2.93 in.	2.56 in.

Make nozzle selection based on desired application rate, water supply, and pressure availability. Optimal operating pressure for all nozzles is between 40 - 50 psi.

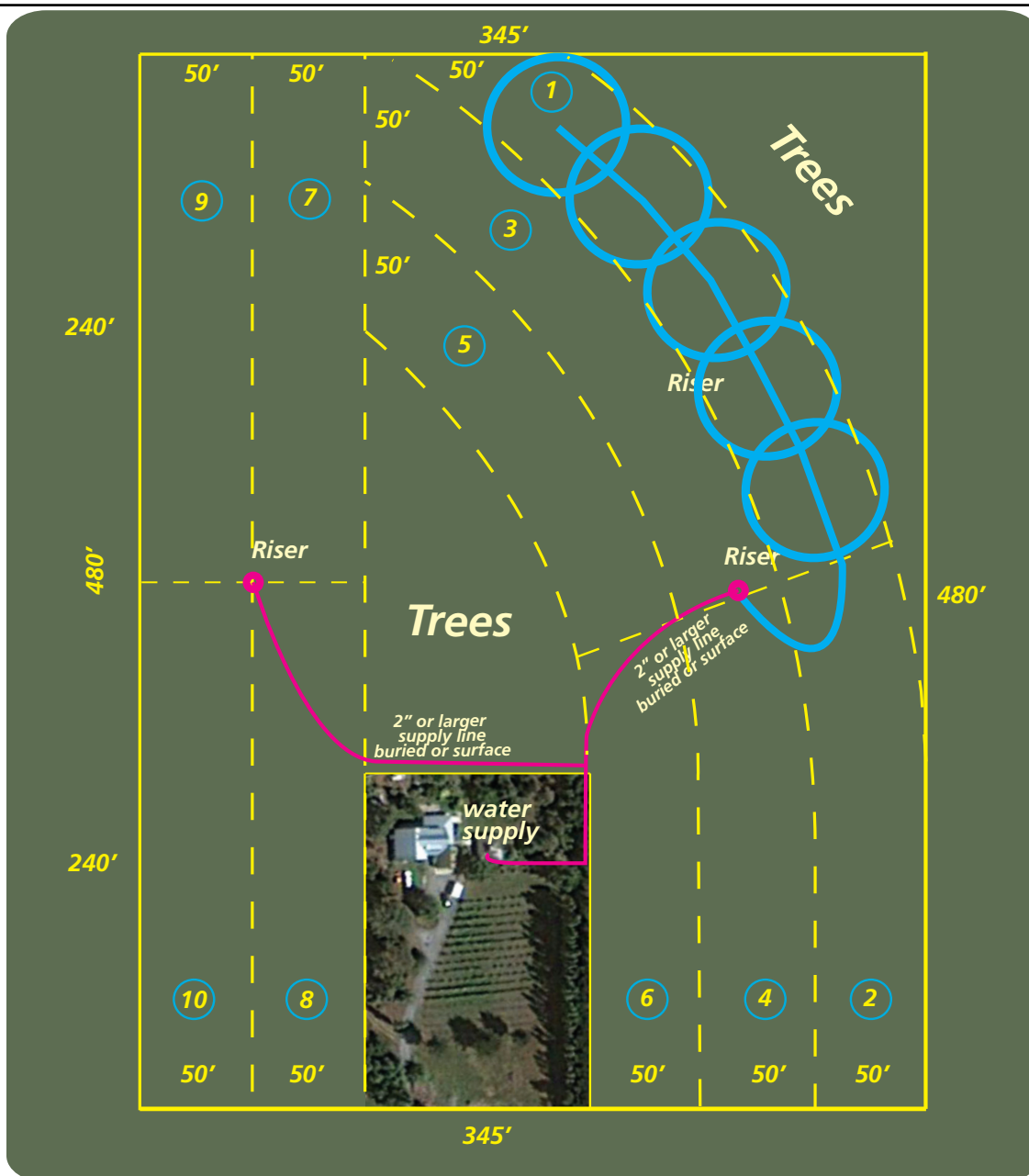

Design Specifications

Size of total area to be irrigated	2.5 Acres
Number of sets or watering days required	10 days
Distance between sprinkler pods	48 ft.
Set widths	50 ft.
Sprinkler nozzle color and size	Orange 2.8mm
Operating pressure available	46.5 PSI
Sprinkler application rate in inches per hour	0.10\" / hr.
Length of watering time per set	12 hours
Total amount of irrigation water applied during each set period	1.18 in.
System capability in inches per week applied	1.65 in.
Number of sprinkler pods per K-LINE®	5
Output per sprinkler	2.5 gal. / min.
Total US gallons per minute needed for this area	12.5 gpm

Notes

K-LINE® works easily around curves or other obstacles. On soil with good water holding capacity, the shift rotations can be increased by using additional riser locations. In the plan, the area irrigated would be completed in 10 day rotations.



Sample Design 5: Two K-LINE® 5 Pod / 2.5 Acre (Ex) Kits Combined Shifting once per day

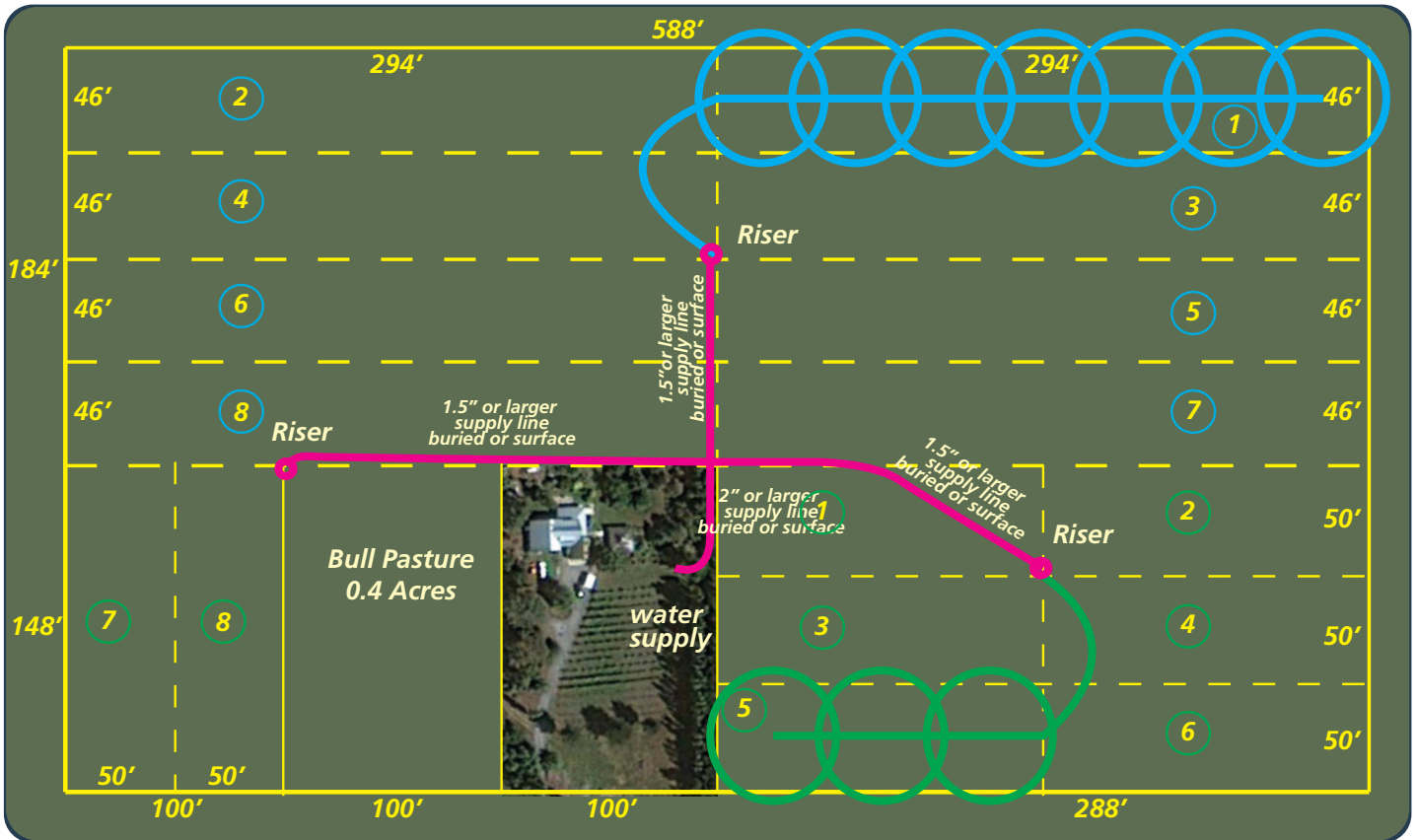

Design Specifications

	1 - 8	1 - 8	Totals
Size of total area to be irrigated	2.7 Ac.	1.4 Ac.	4.1 Ac.
Number of sets or watering days required	8 days	8 days	8 days
Distance between sprinkler pods	42 ft.	50 ft.	
Set widths	46 ft.	50 ft.	
Sprinkler nozzle color and size	Orange 2.8mm	Red 3.0mm	
Operating pressure available	46 psi	46 psi	
Sprinkler application rate in inches per hour	0.11" / hr.	0.12" / hr.	
Length of watering time per set	12 hours	12 hours	
Total amount of irrigation water applied during each set period	1.34 in.	1.38 in.	
System capability in inches per week applied			2.36 in.
Number of sprinkler pods per K-LINE®	7	3	10
Output per sprinkler	2.35 gpm	2.78 gpm	
Total US gallons per minute needed for this area	16.45 gpm	8.34 gpm	24.79 gpm

Notes

This layout can be best irrigated with 2 separate K-LINE® sprinkler pod lines. One line has 7 pods and the other has 3 pods. Because the shift width and pod spacing is different for each K-LINE®, using a red nozzle in one and an orange nozzle in the other will equalize the water application rate.

Sample Design 6: K-LINE® Irrigation for your Sports Field

This design concept can be used for nearly any type of sports field. This particular football field design consists of a 5 pod system with 6 sets (or shifts).

The pods are spaced at 36 ft. intervals, but spacing can be increased up to approximately 50 ft. to accommodate your field. The set or shift widths are 53 ft. wide but should not be increased any further. However, the set width could be made more narrow, and therefore another full set added.

When water is applied at 46 PSI with an impact sprinkler with a black 4.0mm nozzle, the application rate is approximately 0.19 inches per hour. In this design, your total water requirement is approximately 176 ft.³ / hour.

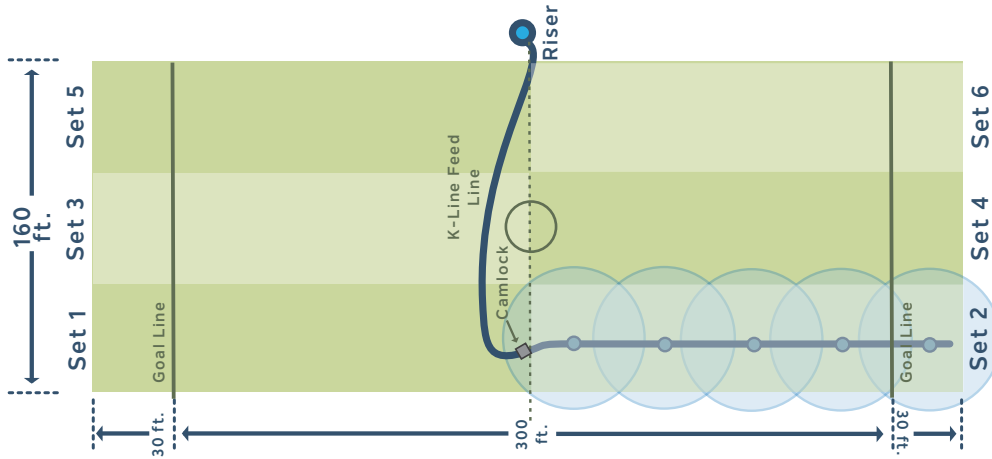

Another shifting alternative is that the operator can either move the line every hour through the course of 6 hours, or every 2 hours over the course of 12 hours.

Application amounts can be altered using different nozzle sizes and/or by adjusting watering time.

How to select an additional pack for your K-LINE® system

Nozzle Color Inches / Hour @ 43.5 PSI	3 (300 ft.)	4 (400 ft.)	5 (500 ft.)	6 (600 ft.)	7 (700 ft.)	8 (800 ft.)	9 (900 ft.)	10 (1000 ft.)
Orange 0.098" / Hr.	3 1 1/4"	4 1 1/4"	5 1 1/4"	3 & 3 1 1/4"	3 & 4 1 1/4"	3 & 5 1 1/4"	4 & 5 1 1/4"	5 & 5 EXTN 1 1/4" - 1 1/2"
Red 0.114" / Hr.	3 1 1/4"	4 1 1/4"	5 1 1/4"	3 & 3 1 1/4"	3 & 4 1 1/4"	3 & 5 1 1/4"	4 & 5 EXTN 1 1/4" - 1 1/2"	5 & 5 EXTN 1 1/4" - 1 1/2"
Green * 0.126" / Hr.	3 1 1/4"	4 1 1/4"	5 1 1/4"	3 & 3 1 1/4"	3 & 4 1 1/4"	3 & 5 EXTN 1 1/4" - 1 1/2"	4 & 5 EXTN 1 1/4" - 1 1/2"	5 EXTN & 5 EXTN 1 1/2"
Blue * 0.146" / Hr.	3 1 1/4"	4 1 1/4"	5 1 1/4"	3 & 5 EXTN (2 spare pods) 1 1/4"	3 & 5 EXTN (1 spare pod) 1 1/4" - 1 1/2"	3 & 5 EXTN 1 1/4" - 1 1/2"	4 & 5 EXTN 1 1/4" - 1 1/2"	5 EXTN & 5 EXTN 1 1/2"
Black 0.189" / Hr.	3 1 1/4"	4 1 1/4"	5 1 1/4"	3 & 5 EXTN (2 spare pods) 1 1/4" - 1 1/2"	3 & 5 EXTN (1 spare pod) 1 1/4" - 1 1/2"	3 & 5 EXTN 1 1/4" - 1 1/2"		
	1 1/4" Feed Line	1 1/4" Feed Line	1 1/4" Feed Line	1 1/4" Feed Line	1 1/4" Feed Line	1 1/4" Feed Line	1 1/4" Feed Line	1 1/2" Feed Line

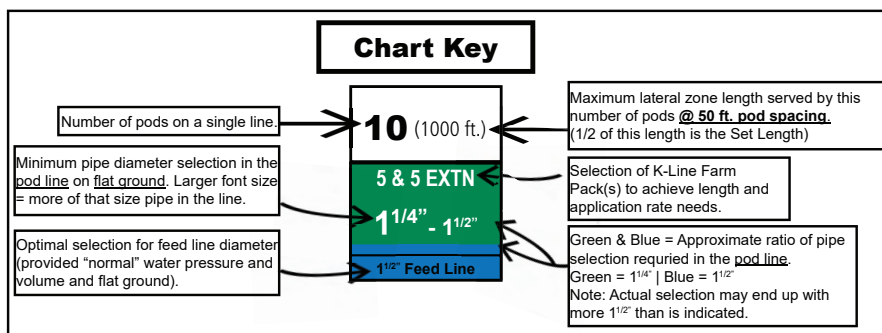

* Green and Blue nozzles not included in Farm Packs but are available for purchase, separately.