



PERDIX

OPERATING INSTRUCTION

MANUAL



SHEARWATER

Powerful • Simple • Reliable

CONTENTS

INTRODUCTION	5
MODELS COVERED BY THIS MANUAL	6
MODES COVERED BY THIS MANUAL	6
FEATURE LIST	7
INSTALLING STRAPS OR BUNGEE CORD	8
BUNGEE CORD	9
TURNING ON	10
COLOUR CODING	12
THE TOP ROW	13
THE CENTER ROW	17
CENTER ROW CONFIGURATION	18
THE BOTTOM ROW	20
INFO SCREENS	23
COMPASS	29
AIR INTEGRATION	32
SIMPLE EXAMPLE DIVE	34
COMPLEX EXAMPLE DIVE	35
GAUGE MODE	39
STOPWATCH	39
RESETTABLE AVERAGE DEPTH	39
DECOMPRESSION AND GRADIENT FACTORS	40
MENU STRUCTURE	43
OPEN CIRCUIT MENU STRUCTURE	43
CLOSED CIRCUIT (INT. PPO2) MENU STRUCTURE	44
GAUGE MENU STRUCTURE	45
MENU REFERENCE	46
TURN OFF	46
SWITCH SETPOINT	47
SELECT GAS	48
RADIO STATION GASES	49
SWITCH TO CC/BO	52
DIVE SETUP	52
LOW SETPOINT	52
HIGH SETPOINT	53
DEFINE GAS	54
DIVE PLANNER	57
NDL DISPLAY	60

CONTENTS

BRIGHTNESS	63
DIVE LOG MENU	64
DISPLAY LOG.....	64
EDIT LOG NUMBER.....	64
RESTORE MODE	65
DELETE ALL LOGS	65
SYSTEM SETUP	66
MODE SETUP.....	67
DECO SETUP	69
OC GASES	69
CC GASES	69
AUTO SP (SETPOINT) SWITCH.....	70
DISPLAY SETUP.....	71
COMPASS SETUP	74
SYSTEM SETUP	76
ADVANCED CONFIGURATION 1.....	77
ADVANCED CONFIGURATION 2.....	78
ADVANCED CONFIGURATION 3.....	79
STARTING BLUETOOTH	80
FIRMWARE UPDATE	80
FIRWARE UPDATE USING SHEARWATER DESKTOP	81
FIRWARE UPDATE USING SHEARWATER CLOUD MOBILE.....	82
DIVE LOG DOWNLOAD.....	83
DIVE LOG DOWNLOAD WITH SHEARWATER DESKTOP.....	83
DIVE LOG DOWNLOAD WITH SHEARWATER CLOUD MOBILE.....	85
CHANGING THE BATTERY	86
BATTERY TYPES	87
BEHAVIOR ON BATTERY CHANGE.....	88
ALERT DISPLAYS.....	91
TROUBLESHOOTING.....	95
STORAGE AND MAINTENANCE	96
SERVICING.....	96
SPECIFICATIONS.....	97
FCC WARNING	98
INDUSTRY CANADA WARNING	98
CONTACT.....	99



DANGER

This computer is capable of calculating deco stop requirements. These calculations are at best a guess of the real physiological decompression requirements. Dives requiring staged decompression are substantially more risky than dives that stay well within no-stop limits.

Diving with rebreathers and/or diving mixed gases and/or performing staged decompression dives and/or diving in overhead environments greatly increases the risk of scuba diving.

YOU REALLY ARE RISKING YOUR LIFE WITH THIS ACTIVITY.



WARNING

This computer has bugs. Although we haven't found them all yet, they are there. It is certain that there are things that this computer does that either we didn't think about, or planned for it to do something different. Never risk your life on only one source of information. Use a second computer or tables. If you choose to make riskier dives, obtain the proper training and work up to them slowly to gain experience.

This computer will fail. It is not whether it will fail but when it will fail. Do not depend on it. Always have a plan on how to handle failures. Automatic systems are no substitute for knowledge and training.

No technology will keep you alive. Knowledge, skill, and practiced procedures are your best defense (Except for not doing the dive, of course).



INTRODUCTION

The Shearwater Perdix is an advanced technical diving computer for open and closed circuit divers.

Although we strive to make the Perdix easy enough to use without reading the manual, please take some time to read this manual to get the best performance from your new computer. Diving involves risk and education is your best tool for managing this risk.

MODELS COVERED BY THIS MANUAL

This manual provides operating instructions for the Perdix and Perdix AI.

Some features presented in this manual only apply to the Perdix AI. These items are clearly identified with a (Perdix AI only) note.

Detailed descriptions of AI features can be found in the [PERDIX AI Operating Instructions manual](#).

MODES COVERED BY THIS MANUAL

This manual provides operating instructions for the Perdix in the following technical operating modes:

- Open Circuit Technical (OC Tec)
- Closed Circuit / Bail Out (CC/BO)
- Gauge

The Shearwater Perdix also has an Open Circuit Recreational mode (OC Rec). For detailed instructions on OC Rec mode operation, please see the Shearwater Perdix [Recreational Nitrox Mode Manual](#).

FEATURE LIST



- Depth, time, and deco info display
- Bühlmann decompression model with gradient factors conservatism
- Optional VPM-B decompression model
- Imperial and metric displays
- Available in Standalone (SA) model only
- A menu system that adapts to diving status
- Automatic turn off after 15 minutes on the surface
- Depth sensor functions past 300msw, crush pressure rating is 260msw (this is due to the case)
- Dive Planner
- Any combination of oxygen, nitrogen, and helium (Air, Nitrox, Trimix)
- Open and closed circuit, switchable during a dive
- 5 CC and 5 OC gases
- Gases can be changed and added during a dive
- CNS tracking
- No lockout from violating deco stops
- Automatic PPO2 set-point switching (configurable)
- Two internal PPO2 set-points for use with a rebreather
- Flexible user replaceable battery. Almost any 'AA' type
- Tilt compensated digital compass
- 1000 hour dive log memory
- Log downloads and firmware upgrades using Bluetooth

YouTube PERDIX INTRODUCTION

To see a video introduction to the Shearwater Perdix visit our YouTube page:

<https://youtu.be/j8MxzI2u7Ow>



INSTALLING STRAPS OR BUNGEE CORD

The Perdix includes mounting points for either two elastic straps or two bungee cords. Both types are included in the box.

STRAPS

Install the elastic straps as shown in the image below. The buckles feature a locking mechanism to prevent them from inadvertently loosening. Press the tab to allow the buckle to slide freely on the straps. Strap width is 3/4" (19 mm).

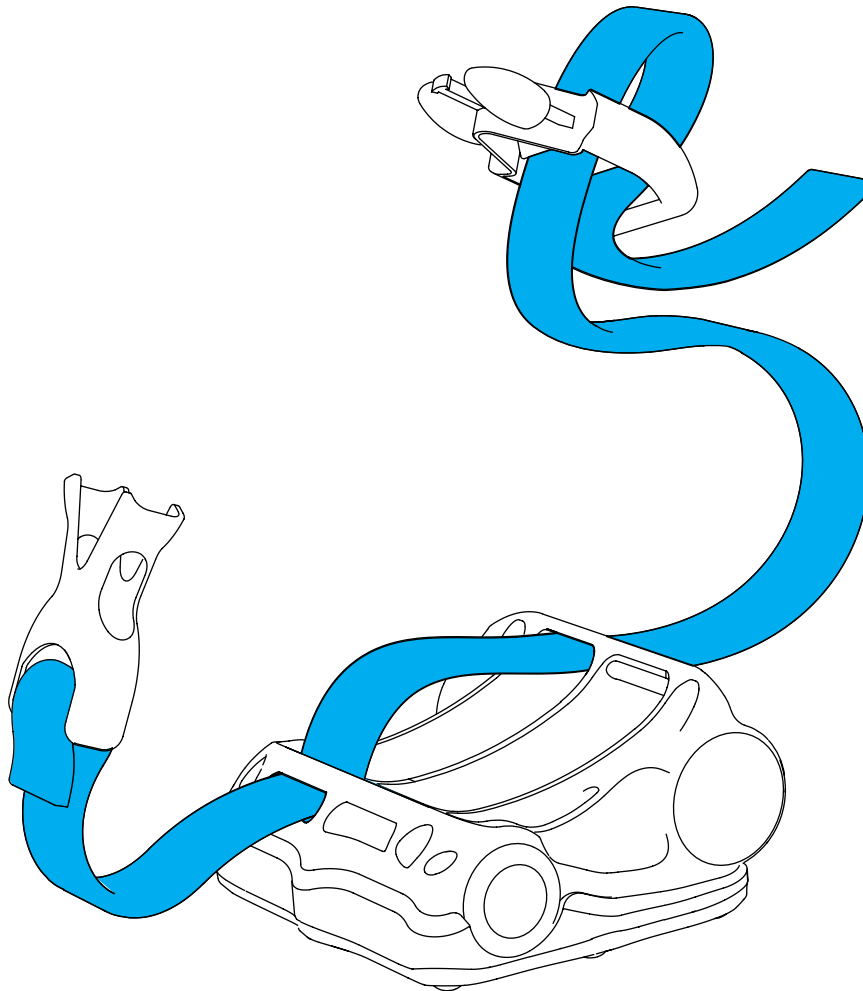

Install the straps and buckles as shown

BUNGEE CORD

Bungee cord can be installed in many ways based on your preference. Two examples are shown. The holes are sized for 3/16" (4.8 mm) diameter cord.



Allergy Alert! The supplied elastic surgical tubing contains LATEX.

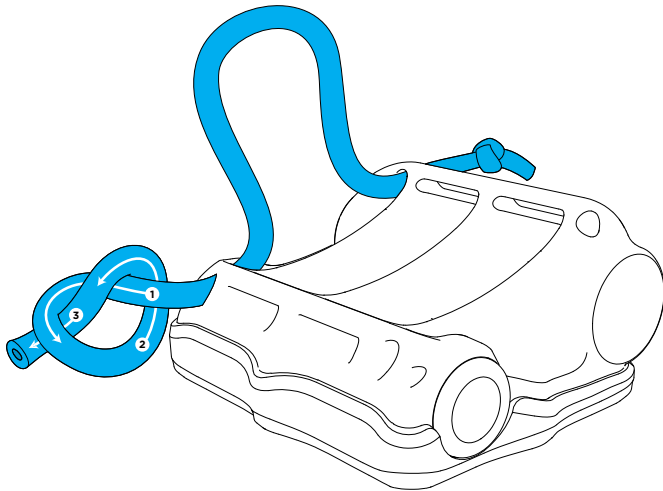

A simple overhand knot (at left) works well to secure the bungee cord.

However, this knot can pull through the mounting holes under very high load.

We find that the knot shown on the right works well.

This knot has the nice feature of creating loops that stay wide open while putting the Perdix on your wrist.

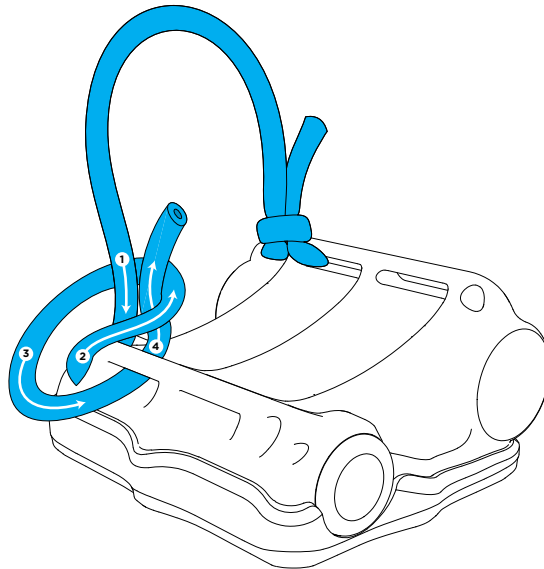

Tip: Use two pieces of cord

When using the bungee cord, always create two independent loops so that a single break does not result in a lost dive computer. If using a single continuous piece of cord, isolate the sides with a knot.

TURNING ON

To turn the Perdix on, press both the MENU (left) and the SELECT (right) buttons at the same time.



Auto-On

The Perdix will automatically turn-on when submerged underwater. This is based on pressure increase and not on the presence of water.



DO NOT RELY ON THE AUTO-ON FEATURE

This feature is supplied as a backup for when you forget to turn on your Perdix. Shearwater recommends turning on manually before each dive to confirm proper operation and to double check battery status and setup.

Auto-On Details

The Perdix turns on automatically when the absolute pressure is greater than 1100 millibar (mbar). For reference, normal sea level pressure is 1013 mbar and 1 mbar of pressure corresponds to approximately 1 cm (0.4") of water.

So the Perdix will automatically turn-on when about 0.9 m (3 ft) underwater when at sea level. If at higher altitude, then the Perdix auto-on will occur at a deeper depth. For example, when at 2000 m (6500 ft) altitude the atmospheric pressure is only about 800 mbar. Therefore, at this altitude the Perdix must be submerged underwater by 300 mbar to reach an absolute pressure of 1100 mbar. This means the auto-on occurs at about 3 m (10 ft) underwater when at an altitude of 2000 m.

BUTTONS

Two piezo-electric buttons are used to change settings and view menus.

 Except for turning the Perdix on, all operations are simple single button presses.

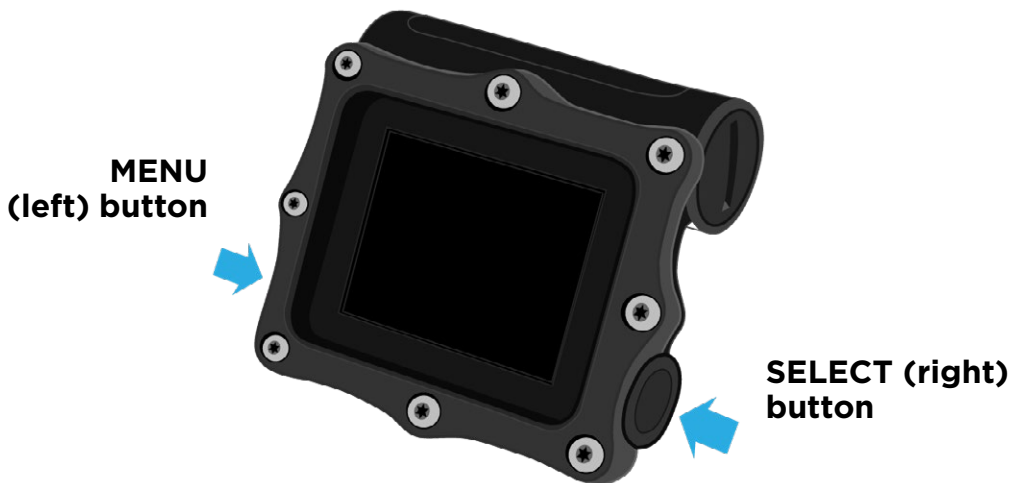

Don't worry about remembering all the button rules below. Button hints make using the Perdix easy.

MENU button (Left)

- From main screen > Brings up the menu
- In a menu > Moves to the next menu item
- Editing a setting > Changes the setting's value

SELECT button (Right)

- From main screen > Steps through information screens
- In a menu > Performs command or starts editing
- Editing a setting > Saves the setting's value

BOTH BUTTONS

When Perdix is off pressing MENU and SELECT at the same time will turn the Perdix on. No other operation requires pressing both buttons at the same time.

BUTTON HINTS

When in a menu, button hints label each button.

For example, the hints to the right tell us:

-  Use MENU to **change** the brightness value.
-  Use SELECT to **save** the current value.

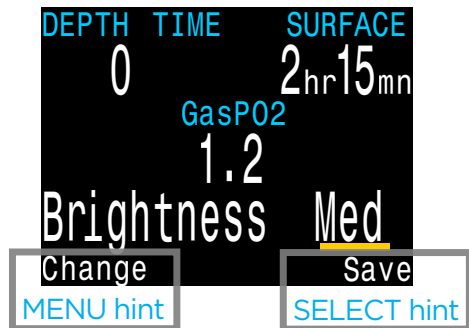

THE MAIN SCREEN

The main screen shows the most important information needed for technical diving.



COLOUR CODING

Colour coding of text draws attention to problems or unsafe situations.

WHITE text indicates normal conditions.

YELLOW is used for warnings that are not immediately dangerous but should be addressed.

FLASHING RED is used for critical alerts that could be life threatening if not immediately addressed.



Sample warning - a better gas is available

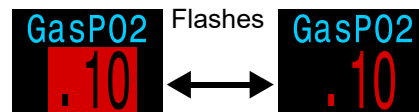

Sample critical alert - continuing to breathe this gas could be fatal

COLOR BLIND USERS

The warning or critical alert states can be determined without the use of color.

Warnings display on a solid inverted background. Warning - doesn't flash.



Critical alerts flash between inverted and normal text. Critical alert - flashes.

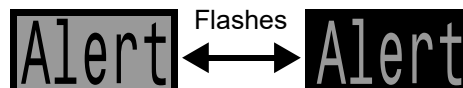

THE TOP ROW

The top row shows depth and time information



Depth

Imperial: In feet (no decimal places).

Metric: In meters (displays with 1 decimal place up to 99.9m)



Note: If the depth shows a Flashing Red zero or shows at depth at the surface, then the depth sensor needs service.

Ascent Bar Graph

Shows how fast you are currently ascending.

Imperial: 1 arrow per 10 feet per minute (fpm) of ascent rate.

Metric: 1 arrow per 3 meters per minute (mpm) of ascent rate.



White when 1 to 3 arrows
30 fpm / 9 mpm



Yellow when 4 to 5 arrows
50 fpm / 15 mpm



Flashes Red when 6 arrows plus
60+ fpm / 15+ mpm

Note: Deco calculations assume 33fpm (10mpm) ascent rate.

Dive Time

The length of the current dive in minutes.

The seconds display as a bar drawn below the word "Time." It takes 15 seconds to underline each character in the word. Does not display the seconds bar when not diving.



in minutes



seconds bar
at about 40s

Battery Icon

The default behavior is that the battery icon is shown on the surface but disappears when diving. If low or critical then the battery icon will appear while diving.

Yellow when the battery needs to be changed.

Red when the battery must be replaced immediately.



OK



low battery



Change battery

Stop Depth and Time

Stop - The next decompression stop depth in the current units (feet or meters). This is the shallowest depth to which you can ascend.

Time - The time in minutes to hold the stop.



Stop at 90ft for 2 min

Will **Flash Red** if you ascend shallower than the current stop.



Alert - depth is shallower than the 90ft stop depth

By default the Perdix uses a 10ft (3m) last stop depth. At this setting, you may perform the last stop at 20ft (6m) with no penalty. The only difference is that the predicted time-to-surface will be shorter than the actual TTS since off-gasing is occurring slower than expected.

There is also an option to set the last stop to 20ft (6m) if you wish.

Surface Interval

When on the surface, the STOP DEPTH and TIME are replaced by a surface interval display.

Shows the hours and minutes since the end of your last dive. Above 4 days, the surface interval is displayed in days.

The surface interval is reset when the decompression tissues are cleared. See the section on Tissues Cleared.

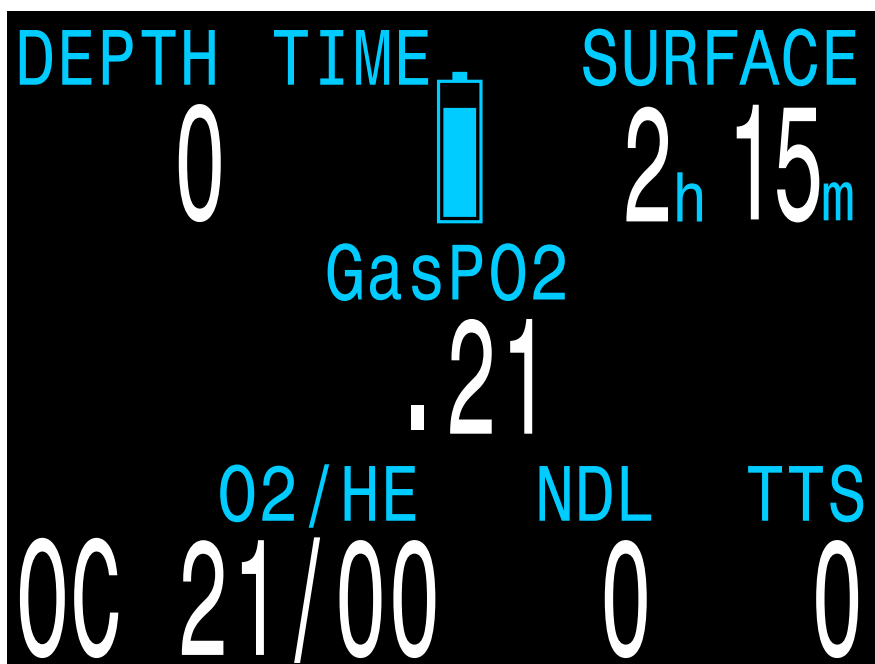





Sample surface main screen showing the surface interval

THE CENTER ROW

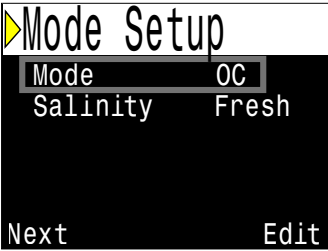
The center row displays PPO2. PPO2 units are absolute atmospheres (1ata = 1013mbar).

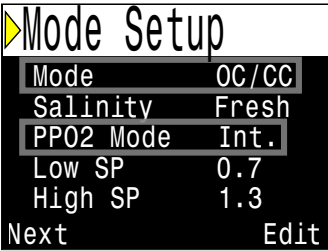
The layout varies depending on the current mode

Mode	Menu Setup	Center Row Display
Open Circuit		
Closed Circuit with Internal PPO2 Setpoints		

In CC mode, PPO2 displays in **Flashing Red** when less than 0.40 or greater than 1.6.

In OC mode, PPO2 displays in **Flashing Red** when less than 0.19 or greater than 1.65.

The above limits can be adjusted in the [Adv. Config 2](#) menu.

CENTER ROW CONFIGURATION

In most modes, the center row displays can be customized.

The center position can only display PPO2. In OC only mode, the PPO2 display can optionally be turned off.

Configure the center row in the System Setup → Center Row Menu.

The left and right positions can be set to display the following:

Centre Row	
Left	Max Depth
Center	Gas PPO2
Right	None
Next	Edit

DEPTH	TIME	STOP	TIME
200	22	130	1
MAX 225 _{ft}	GasP02 1.15		
00	02/HE 15/40	NDL 0	TTS 56

Custom Display

The centre row on the Perdix is configured the same way as on a Shearwater Petrel. See below for a video walkthrough of how to configure the center row.

Watch the video:
[Configurable Center Row](#)

Center Row Options

Option	Description
None	Blank (default value).
Max Depth	The maximum depth of the current or previous dive.
Avg Depth	The average depth of the current or previous dive.
@+5	The TTS if remaining at current depth for 5 more minutes.
Δ +5	The difference between current TTS and @+5.
Ceil	The current decompression ceiling (not rounded to the stop interval).
GF99	The Bühlmann ZHL-16C super-saturation percent gradient.
CNS	Central Nervous System (CNS) toxicity clock as a percentage.
Clock	The time-of-day in 24hr or am/pm format (same as system setting). Does not show "am" or "pm".
DET	Dive End Time. The time-of-day when the dive will end (i.e. Clock plus TTS). In 24hr or am/pm format (same as system setting). Does not show "am" or "pm".
Timer	Timer (stopwatch) display.
Compass	A miniature compass. Works like a regular compass with the red end of the needle always points to North.
TEMP	The current temperature in Celsius or Fahrenheit.
AI T1	The pressure transmitted by transmitter T1. (Perdix AI only)
AI T2	The pressure transmitted by transmitter T2. (Perdix AI only)
AI GTR	The gas time remaining for selected transmitter (Perdix AI only)
AI SAC	The surface Air consumption for the selected transmitter (Perdix AI only)
AI Mini	The pressure transmitted by transmitters T1 and T2 in a compact format. (Perdix AI only)
Dil PPO2	The diluent PPO2 at the current depth (Only available when CC is available).
FiO2	The fraction of inspired O2 as a percentage (Only available when CC or SC is available).

THE BOTTOM ROW

The bottom row displays the current mode, gas and decompression information.



Circuit Mode

The current breathing configuration. One of:

OC

OC = Open circuit

SC

SC = Semi-closed circuit

CC

CC = Closed circuit

BO

BO = Bailout
(when CC available, displays in **Yellow** to indicate bailout condition)

Current Gas (O₂/He)

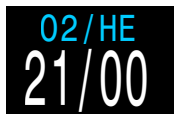

Air

21% O₂
79% N₂

The current gas shown as a percentage of Oxygen and Helium. The remainder of the gas is assumed to be Nitrogen.

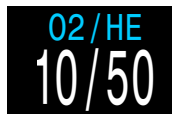

Tx

10% O₂
50% He
40% N₂

In closed circuit mode, this gas is the diluent. In open circuit mode this is the breathing gas.



A better deco gas available

Displays in **Yellow** when there is better deco gas available than the current gas.

No Decompression Limit (NDL)

NDL
20

The time remaining, in minutes, at the current depth until decompression stops will be necessary. Displays in **Yellow** when the NDL is less than 5 minutes.

NDL
5

Once NDL reaches 0 (i.e. deco stops needed), the NDL display is just wasting space. To address this, a few different values can be set to replace the NDL (see [Dive Setup](#) → [NDL Display](#)). The options are listed below.

NDL Replacement Options

GF99
80%

GF99: The raw percentage of the Bühlmann allowable supersaturation at the current depth.

@+5
20

@+5: The predicted time-to-surface (TTS) if you were to stay at the current depth for 5 more minutes.

CEIL
74

CEIL: The current ceiling in the current units (feet or meters). **Flashes Red** if you ascend shallower than the current ceiling.

TTS
35

Time-to-Surface (TTS):
The time-to-surface in minutes. This is the current time to ascend to the surface including the ascent plus all required deco stops.

Assumes:

- ✔ Ascent rate of 33 feet per minute (10 meters per minute).
- ✔ Decompression stops will be followed.
- ✔ Programmed gases will be used as appropriate.

Δ+5
4

Δ+5: The predicted change in time-to-surface if you were to stay at the current depth for 5 more minutes.

The bottom row is also used to show additional information.

By using only the bottom row for this additional information, the critical information contained on the Top and Center Rows is always available during a dive.

The additional information that can be displayed on the bottom row includes:

Info:

Shows additional dive information.

Info Screens:

Press SELECT (right button) to step through info screens.

Menus:

Allows changing settings.

Press MENU (left button) to enter menus.

Warnings:

Provide important alerts.

Press SELECT (right button) to clear a warning.

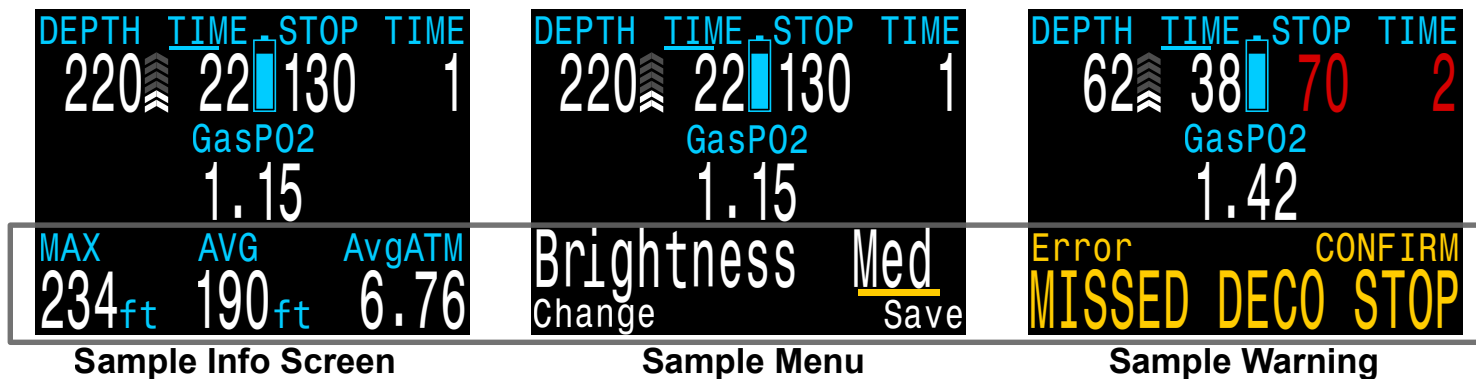

The bottom row is used to display additional information

INFO SCREENS

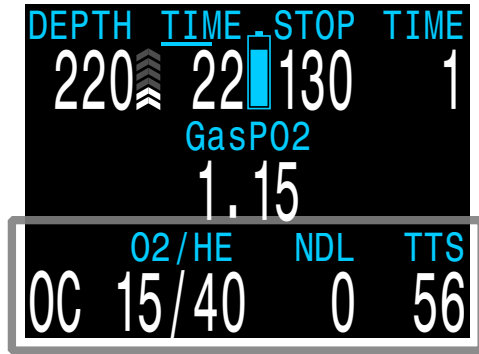

Info screens display on the bottom row.

Press SELECT (right) button to step through the info screens.

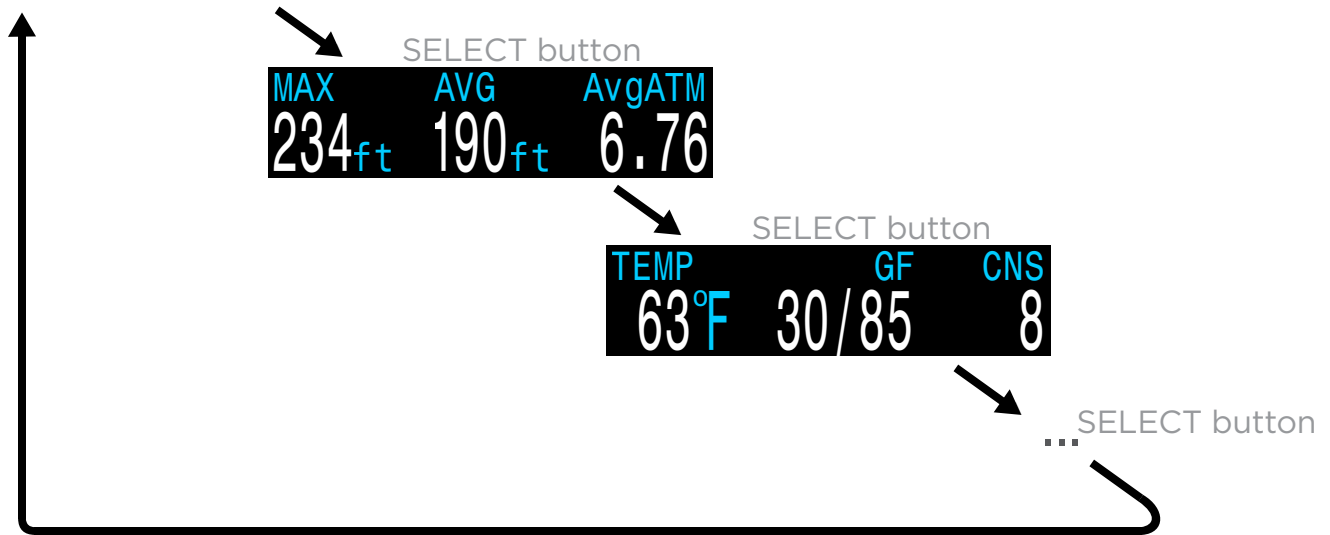

Info screens provide additional information that does not fit on the main screen.

Starting from the main screen, the SELECT (right) button steps through the info screens. If the compass is turned on, two presses of the SELECT button will bring up the first info screen. The example above depicts infoscreen sequencing with the compass turned off.

When all info screens have been viewed, pressing SELECT again will return to the main screen.

With the exception of the compass, tissue bar graph, and AI screens (Perdix AI only), info screens time-out after 10 seconds, returning to the main screen.

Pressing the MENU (left) button will also return to the main screen.

The info screen content is optimized for each mode. Set the Perdix to the mode you will be using (e.g. OC) and step through the info screens to get familiar with the content.

The next section describes the individual values shown on the info screens.

AVG
50 ft

Average Depth

Displays the average depth of the current dive, updated once per second. When not diving, shows the average depth of the last dive.

AvgATM
2.52

Average Depth in Atmospheres (AvgATM)

The average depth of the current dive, measured in absolute atmospheres (i.e. a value of 1.0 at sea level). When not diving, shows the average depth of the last dive.

MAX
260 ft

Maximum Depth

The maximum depth of the current dive. When not diving, displays the maximum depth of the last dive.

CNS
11

CNS Toxicity Percentage

Central Nervous System oxygen toxicity loading percentage. **Flashes Red** when 100 or greater.

CNS
100

The CNS percentage is calculated continuously, even when on the surface and turned off. When deco tissues are reset, the CNS will also be reset.

The CNS value (short for Central Nervous System Oxygen Toxicity) is a measure of how long you have been exposed to elevated partial pressures of oxygen (PPO2) as a percentage of a maximum allowable exposure. As PPO2 goes up, the maximum allowable exposure time goes down. The table we use is from the NOAA Diving Manual (Fourth Edition). The computer linearly interpolates between these points and extrapolates beyond them when necessary. Above a PPO2 of 1.65 ata, the CNS rate increases at a fixed rate of 1% every 4 seconds.

During a dive the CNS never decreases. When back at the surface, a half-life of elimination of 90 minutes is used. So for example, if at the end of the dive the CNS was 80%, then 90 minutes later it will be 40%. In 90 more minutes it will be 20%, etc. Typically after about 6 half-life times (9 hours), everything is back close to equilibrium (0%).

**PPO2**

Redundant PPO2 display. Useful if center row PPO2 has been disabled.

In CC mode, displays in **Flashing Red** when less than 0.40 or greater than 1.6.

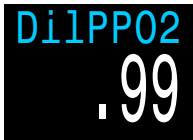

In OC mode, displays in **Flashing Red** when less than 0.19 or greater than 1.65.

**Diluent PPO2**

Only displayed in CC mode. Displays in **Flashing Red** when the partial pressure of the diluent is less than 0.19 or greater than 1.65.

When performing a manual diluent flush, you can check this value to see what the expected PPO2 will be at the current depth.

**Fraction Inspired O2 (FiO2)**

The fraction of the breathing gas composed of O2. This value is independent of pressure.

Tissues Bar Graph



The tissues bar graph shows the tissue compartment inert gas tissue tensions based on the Bühlmann ZHL-16C model. Note that VPM-B also tracks tensions in the same way.

The fastest tissue compartment is shown on the top, and the slowest on the bottom. Each bar is the combined sum of the nitrogen and helium inert gas tensions. Pressure increases to the right.

The vertical black line shows the inert gas inspired pressure. The boundary between the green and yellow zones is the ambient pressure. The boundary between the yellow and red zone is the ZHL-16C M-Value pressure.

Note that the scale for each tissue compartment above the green zone is different. The reason the bars are scaled in this way is so that the tissues tensions can be visualized in terms of risk (i.e. how close they are as a percentage to Bühlmann's original supersaturation limits). Also, this scale changes with depth, since the M-Value line also changes with depth.

The video below demonstrates how to interpret the tissues bar graph on a Shearwater Petrel. The Perdix's tissue bar graph is identical.



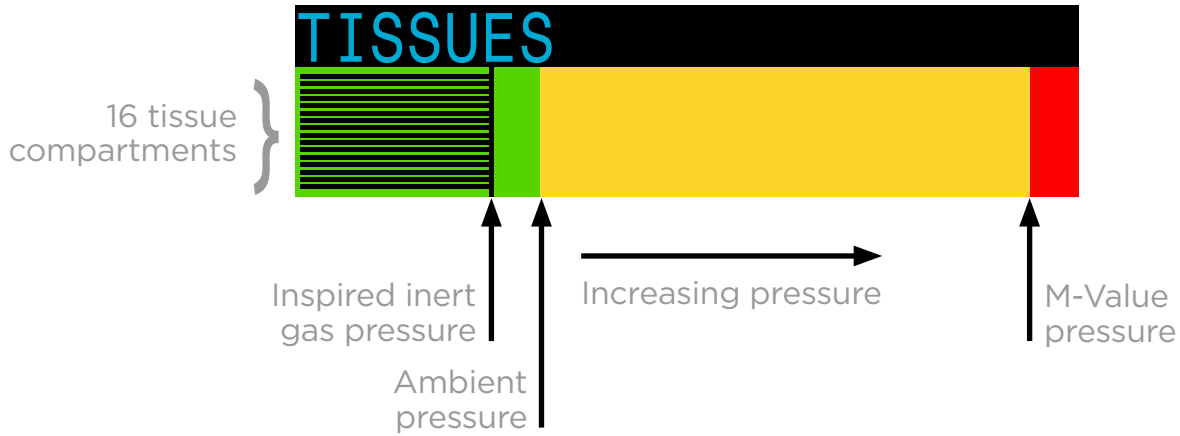

Sample Tissues Graphs



On surface (sat. with air)
 Note: Gas is 79% N₂ (21% O₂, or Air)



After descent



On-gassing



Deep stop



Last deco stop
 Note: Gas is now 50% O₂ and 50% N₂

GF
30/85

Gradient Factor:

The deco conservatism value when the deco model is set to GF. The low and high gradient factors control the conservatism of the Bühlmann GF algorithm. See “Clearing up the Confusion About Deep Stops” by Erik Baker.

VPM-B
+3

VPM-B (and VPM-BG):

The deco conservatism value when the deco model is set to VPM-B.

VPM-BG
+3/90

If the deco model is VPM-B/GFS, also displays the gradient factor for surfacing.

PRESSURE mBar
SURF 1013 NOW 1011

Pressure:

The pressure in millibars. Two values are shown, the surface (surf) pressure and the current (now) pressure. The current pressure is only shown on the surface. The surface pressure is set when the Perdix is turned on. If the Altitude setting is set to SeaLvl, then surface pressure is always 1013 millibars.

TEMP
73 °F

Temperature:

The current temperature in degrees Fahrenheit (when depth in feet) or degrees Celsius (when depth in meters).

BATTERY
3.7V LiIon 3.99V

Battery:

The Perdix’s internal battery voltage. Displays in **Yellow** when the battery is low and needs replacement. Displays in **Flashing Red** when the battery is critically low and must be replaced as soon as possible. Also shows battery type.

DATE TIME DATE TIME
28-Jun-15 16:31 28-Jun-15 4:31pm

Date and Time:

In the format dd-mon-yy
12 or 24 hour clock time.

SERIAL NO VERSION
1234ABCD 2000029

Serial Number & Version:

Each Perdix has a unique serial number.

The version number indicates the available features. The last two numbers are the firmware version (V29 in this image).

COMPASS



The Perdix model contains a tilt-compensated digital compass.

- 🔗 Compass features:
- 🔗 1° resolution
- 🔗 ±5° accuracy
- 🔗 Smooth, high-speed refresh rate
- 🔗 User set heading marker with reciprocal
- 🔗 True North (declination) adjustment
- 🔗 Tilt compensation ±45°

Viewing the Compass

When enabled, the compass is viewed by pressing the SELECT (right) button once. Press SELECT again to continue on to view the regular info screens.

Unlike the regular info screens, the compass never times out back to the main screen. Pressing the MENU (left) button brings up the Mark Heading option. Pressing MENU again returns to the main screen.

A video demonstration of compass operation on the Petrel 2 dive computer can be found below. (operation is the same for Perdix):



Compass

Marking a Heading

To mark a heading, when viewing the compass press the MENU (left) button. This brings up the "Exit Mark" menu. Press the SELECT (right) button to mark the heading.

The marked heading is shown with a green arrow. When within $\pm 5^\circ$ of the heading, the degrees display turns green.

The reciprocal heading (180° from marked heading) is shown with a red arrow. When within $\pm 5^\circ$ of the reciprocal heading, the degrees display turns red.

When more than 5° off the marked heading, a green arrow shows the direction back to the marked heading. Also, the offset degrees to the heading are displayed (16° in the example image). This offset is useful when navigating patterns. For example, a box pattern requires turns at 90° intervals, while a triangle pattern requires 120° turns.

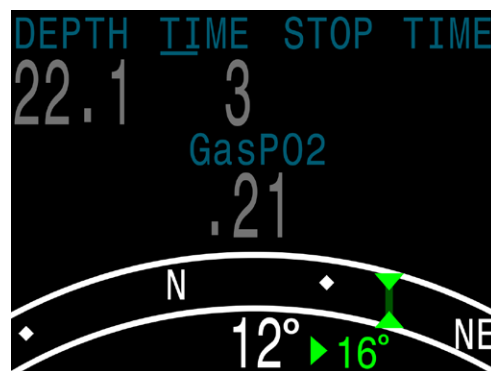
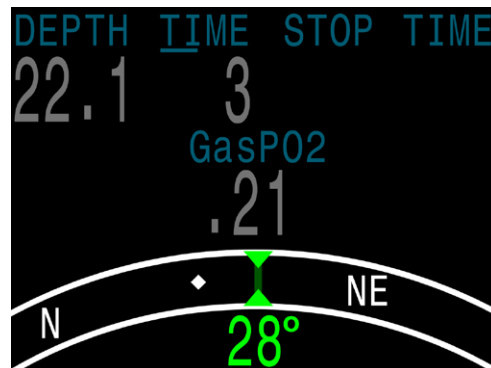
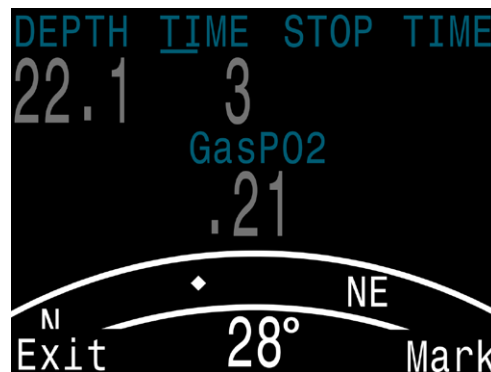

A video demonstration of proper compass calibration on the Petrel 2 dive computer can be found below. (Calibration procedure is the same for Perdix):



Watch the video:
[Compass Calibration](#)

COMPASS

It is important to understand some compass limitations before use.

Calibration:

The digital compass needs occasional calibration. This can be done in the [System Setup](#) → [Compass](#) menu and takes only one minute. See the compass Setup sub-section of the Menu Reference section of this manual for instructions on setting up and calibrating the compass.

Battery Changes:

When the battery is changed, the compass should be calibrated. This is because each battery has its own magnetic signature that interacts with the compass. Fortunately this effect can be removed with proper calibration.

Interference:

Metal objects, permanent magnets, and other sources of magnetic interference such as electric motors should be kept away from the compass. We recommend comparing the compass accuracy to a known good compass with and without the interfering object in place to see if it has an effect.

Shipwrecks may interfere with the compass reading and so the compass function should not be used near or inside of a shipwreck. Use the same discretion and training as you would with a traditional compass.

Magnetic declination (also called magnetic variation) is the difference between magnetic and True North. This can be compensated in the Compass Setup menu using the True North setting. The magnetic declination varies around the world, so will need to be readjusted when travelling.

Magnetic inclination (or magnetic dip) is how much the Earth's magnetic field points up or down. The Perdix compass automatically compensates for this angle. However, in some locations (near the poles) the inclination angle can exceed 80° (i.e. the magnetic field points almost directly up or down), in which case the specified accuracy may not be met.

AIR INTEGRATION



PERDIX AI models are equipped with dual transmitter air integration capability*. For complete information on how to operate the various features of AI, see the [PERDIX AI Operating Instructions manual](#).

Features

- Wireless pressure monitoring of 1 or 2 scuba tanks.
- Units in PSI or Bar.
- Flexible display setup.
- Optional Gas Time Remaining (GTR) and Surface Air Consumption (SAC) rate based on one of the tanks.
- Logging of pressure, GTR, and SAC values at 10 second intervals.
- Average SAC of last dive displayed on surface.
- Warnings when reserve and critical pressures reached.
- Available in all modes
- Can be used to monitor O2 and diluent pressures in rebreathers



USE A BACKUP ANALOG SPG

Always use a backup submersible pressure gauge as a redundant source of gas pressure information.

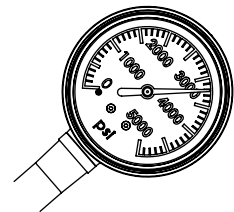

*Air Integration currently unavailable in EU

MENUS

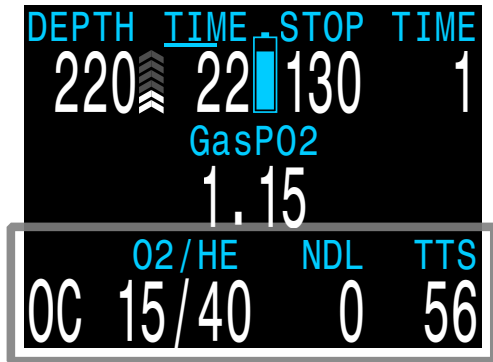

Press MENU (left) button to step through the menus.

Press SELECT (right) button to execute command or enter sub-menu.

Menus display on the bottom row.

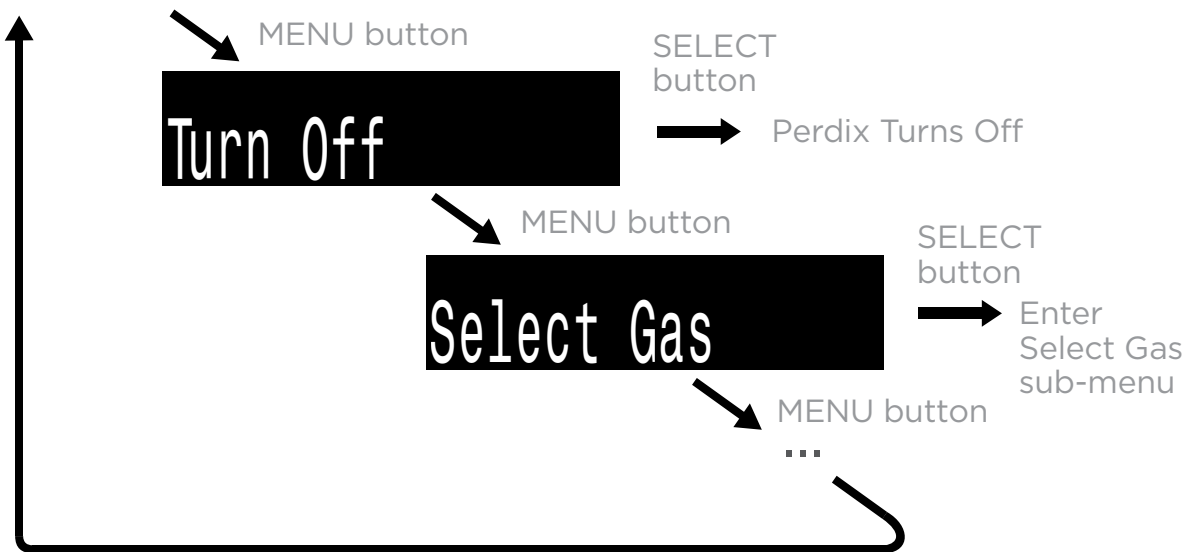

Menus perform actions and allow settings to be changed

Starting from the main screen, pressing the MENU (left) button steps through the menus. When all menus have been viewed, pressing MENU again will return to the main screen.

Pressing the SELECT (right) button when a menu is displayed, either performs that action or enters a sub-menu.

If no buttons are pushed for 1 minute, the menu system will time-out, returning to the main screen. Anything that had been previously saved will be retained. Anything that was in the middle of editing will be discarded.

ADAPTIVE MENUS

Only menus necessary for the current mode are shown. This keeps operation simple, prevents mistakes, and reduces buttons presses.

SIMPLE EXAMPLE DIVE



Watch the video:
[Air - Dive](#)



Here is an example of a simple OC air dive. It will help to introduce the screen displays as the diver progresses, the dive starts, the depth increases. The display is showing the computer programmed for open circuit (OC) air.

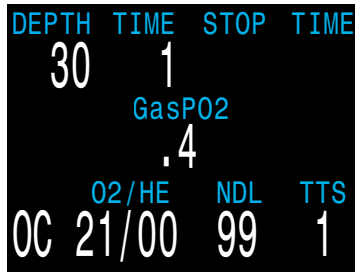

As we pass through 30 feet, the time-to-surface (TTS) shows one minute. This shows that the computer is expecting the diver to ascend at approximately 33 feet per minute or 10 meters per minute. The dive predictions are based on this ascent rate.

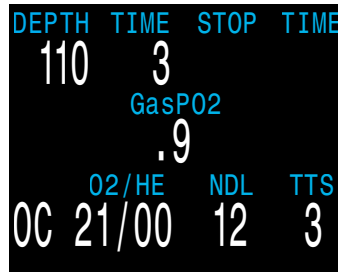

The no-decompression limit (NDL) starts off showing 99, but then starts to show a smaller number as the depth increases. The 3rd screen shows that we will go into deco in 12 minutes.

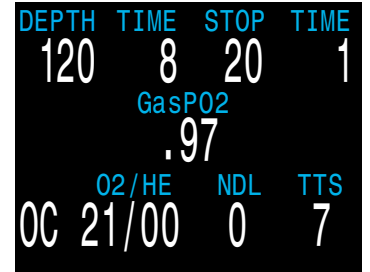

We have now entered decompression. Our first stop, or ceiling, is at 20 feet and we will need to remain there for up to one minute. Although stops are shown in minutes, the computer will calculate and change the ceiling in real time and the stop may be less than a minute.



As we ascend, the ascent rate indicator shows about 20 fpm or 6 mpm.

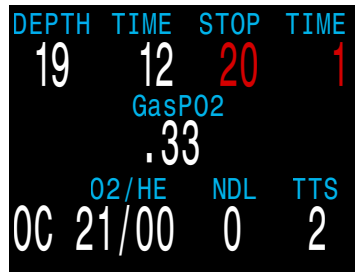

When we go shallower than our first stop, the stop depth starts to flash **red**.

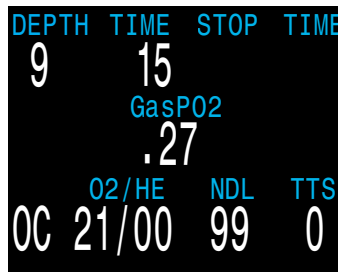

When we clear the last stop, the stop depth and time goes blank, and now we see a NDL of 99 minutes again. Once we surface, the depth is 0 and a minute later when the computer comes out of dive mode, the NDL goes to 0 as well.

COMPLEX EXAMPLE DIVE



Watch the video:
[Deco Dive](#)

This is an example of the displays that might be seen on a dive. This example shows a complicated dive with a trimix gas for Closed Circuit (CC) diluent and multiple Open Circuit (OC) bail-out gases. A normal, single gas CC or OC dive wouldn't have any button pushes at all, so there isn't much to show.

Setup CC Gasses

Best practices include checking your gas lists before each dive. This screen is available in the System Setup menu. For this dive the only CC diluent is trimix 10/50 (10% O2, 50% He, 40% N2).

▶ CC Gasses

A1	CC	On	10/50
2	CC	Off	00/00
3	CC	Off	00/00
4	CC	Off	00/00
5	CC	Off	00/00
Next		Edit	

Setup OC Gasses

For the OC bailout gas list, several gases are needed.

We will verify that we are carrying enough of each gas when we plan the dive.

▶ OC Gasses

1	OC	On	99/00
2	OC	On	50/00
3	OC	On	14/55
4	OC	Off	00/00
5	OC	Off	00/00
Next		Edit	

Verify Settings

It is also prudent to ensure all other settings are correct before starting the dive. We recommend verifying the settings on all system setup pages.

Although gases and some settings can be changed underwater, it is best to have them right from the start.

▶ Deco Setup

Deco Model	GF	ZHL - 16C
Conserv (GF)		30/70
Last Stop		6m
NDL Display		CEIL
Next		Edit

Plan Dive & Bailout

Use the dive planner to check the total runtime, decompression schedule and bailout out gas quantity needed.

For CC dives, both the closed-circuit (CC) and bailout (BO) plans are displayed. The bailout plan also includes how much gas is needed.

The on-board deco planner is limited in functionality, so for complex dives we recommend planning using desktop or smartphone dive planning software.

CC	Depth	Time	RMV	P02
	090	020	15	1.3
Stp	Tme	Run	Gas	
90	bot	20	10/50	
48	asc	25	10/50	
48	1	26	10/50	
45	1	27	10/50	
42	1	28	10/50	
Quit				Next

BO	Depth	Time	RMV	P02
	090	020	15	1.3
Gas Usage, in Liters				
50/00:	2060			
21/00:	729			
10/50:	591			
Quit				Next

Ready to Dive

The dive is now ready to begin



Note on Hypoxic Diluents

Hypoxic diluents such as the 10/50 in this example require special training since they can be deadly near the surface.

DEPTH	TIME	SURFACE
.0		10h58m
	.7	
CC	O2/HE 10/50	NDL 0 TTS 0

DEPTH	TIME	SURFACE
.0		10h58m
	.7	
DilP02	CNS 0	SP .7 AvgP02 .98

Pressing SELECT brings up the first info screen which shows the diluent PPO2. The red indicates it is unsafe to breathe directly.

You can view this info at any time to verify that the diluent is safe or to check what the expected PPO2 will be when flushing with diluent at depth.

Auto Setpoint Switch

The optional auto setpoint switch was enabled with a depth setting of 15m.

So as we cross 15m on the descent, the setpoint automatically switches from 0.7 to 1.3.

DEPTH	TIME	STOP	TIME
16.4	1		
		1.3	
CC	O2/HE 10/50	NDL 95	TTS 2

Decreasing NDL

As we descend deeper, the NDL decreases.

The TTS shows it will take 5 minutes to ascend to the surface at 10m/min (33ft/min).

DEPTH	TIME	STOP	TIME
48.4	3		
		1.3	
	O2/HE	NDL	TTS
CC	10/50	4	5

Bottom Time

We have completed the bottom time.

The TTS indicates we have about 1.5 hours or decompression to do.

The first stop will be at 48m for 1 minute.

DEPTH	TIME	STOP	TIME
90.2	20	48	1
		1.3	
	O2/HE	GF99	TTS
CC	10/50	On Gas	92

Ascending to First Stop

Here we are ascending at 3m/min (each bar beside the depth is 3m/min). This is slower than the expected 10m/min ascent rate.

This slow ascent has caused the TTS to rise, as most tissues are still on-gassing.

DEPTH	TIME	STOP	TIME
61.6	29	48	1
		1.3	
	O2/HE	GF99	TTS
CC	10/50	6%	96

First Deco Stop

The slow ascent has caused the first stop to clear before we reached it. This often happens with slow ascents.

Note that the GF99 value now indicates that the leading tissues are now off-gassing. However, at this deep depth most tissue compartments are still on-gassing.

DEPTH	TIME	STOP	TIME
45.3	34	45	1
		1.3	
	O2/HE	GF99	TTS
CC	10/50	20%	98

A problem has developed

There is a problem with the O2 readings on the rebreather controller and the decision has been made to bail out

After physically switching the BOV or mouthpiece, the computer needs to be set to BO mode for proper deco calculations.

DEPTH	TIME	STOP	TIME
30.4	42	30	2
		1.3	
Switch CC -> BO			

Bailout

Two presses on MENU brings up the "SWITCH CC -> BC" menu. Pressing SELECT makes the change.

Note that "BO" is displayed in yellow to indicate the bailout condition. Additionally, PO2 is not shown in the centre position while in BO mode.

The best BO gas was automatically selected, and the deco schedule has been adjusted based on the BO gases.

DEPTH	TIME	STOP	TIME
30.4	42	30	2
BO	O2/HE 21/00	GF99 45%	TTS 92

Switch Gas

We are now at 21m, having completed a few more deco stops. The gas is now displaying in yellow, indicating a better gas is available.

Pressing MENU twice brings up the "SELECT GAS" menu, and pressing SELECT enters it. With the "new style" gas select menu, the best gas will already be the initial selection, just press SELECT to make it the active gas.

If using the "old style" gas select menu, see the gas select section for instructions.

DEPTH	TIME	STOP	TIME
21.2	53	21	5
BO	O2/HE 21/00	GF99 58%	TTS 80

DEPTH	TIME	STOP	TIME
21.2	53	21	5
▶50/00	21/00	10/50	
Next		Select	

Deco Clear

Follow the deco stops until they have all cleared. Now it is time to ascend and end the dive.

DEPTH	TIME	STOP	TIME
3.1	132	Deco Clear	
BO	O2/HE 50/00	GF99 72%	TTS 1

End of example.

GAUGE MODE

Gauge Mode turns the Perdix into a simple depth and time display (a.k.a. a bottom timer).

Change to Gauge Mode in the [System Setup](#) → [Mode Setup](#) menu.

Since decompression tissues are not tracked in Gauge Mode, changing to or from Gauge Mode resets the deco tissues.

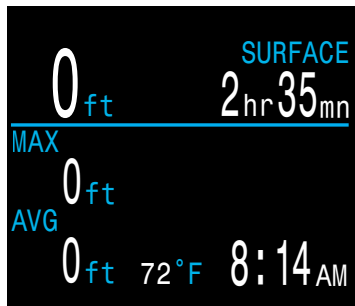

Gauge - Surface Display



Gauge - Dive Display

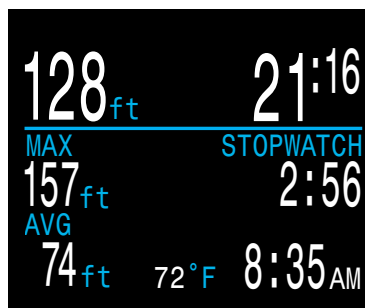

Stopwatch Running

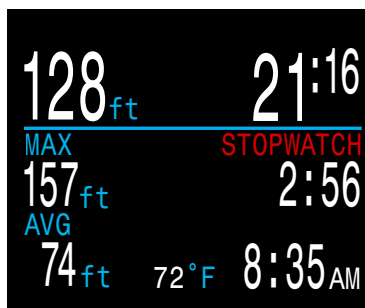

Stopwatch Stopped

Features:

- Extra-Large Depth Display (in feet or meters)
- Extra-Large Time Display (in minutes:seconds)
- Maximum and Average Depth on main screen.
- Stopwatch
- Resettable Average Depth

The Gauge display is organized as:

- Depths along the left.
- Times along the right.
- Most important information (Depth, Dive Time) on the top row.

STOPWATCH

When diving, starting or stopping the Stopwatch is the first menu option.

When stopped, the word “Stopwatch” displays in red.

When non-zero, the stopwatch can be reset. Reset behavior depends on state:

- If running when reset, it continues running, counting up again from 0.
- If stopped when reset, then it is set 0 and remains stopped.

RESETTABLE AVERAGE DEPTH

During a dive, the average depth can be reset.

While on the surface, the MAX and AVG values display the maximum and average depth of the last dive. The AVG depth displayed on the surface is for the entire dive, regardless of whether the reset average depth option was used. The dive log also records the average depth for the entire dive.

DECOMPRESSION AND GRADIENT FACTORS

The basic decompression algorithm used for the computer is Bühlmann ZHL-16C. It has been modified by the use of Gradient Factors that were developed by Erik Baker. We have used his ideas to create our own code to implement it. We would like to give credit to Erik for his work in education about decompression algorithms, but he is in no way responsible for the code we have written.

The computer implements Gradient Factors by using levels of conservatism. The levels of conservatism are pairs of number like 30/70. For a more detailed explanation of their meaning, please refer to Erik Baker's excellent articles: **Clearing Up The Confusion About "Deep Stops"** and **Understanding M-values**. The articles are readily available on the web. You might also want to search for "Gradient Factors" on the web.

The default of the system is 30/70. The system provides several settings that are more aggressive than the default.

Don't use the system until you understand how it works.

Graph from Erik Baker's "Clearing Up The Confusion About Deep Stops"

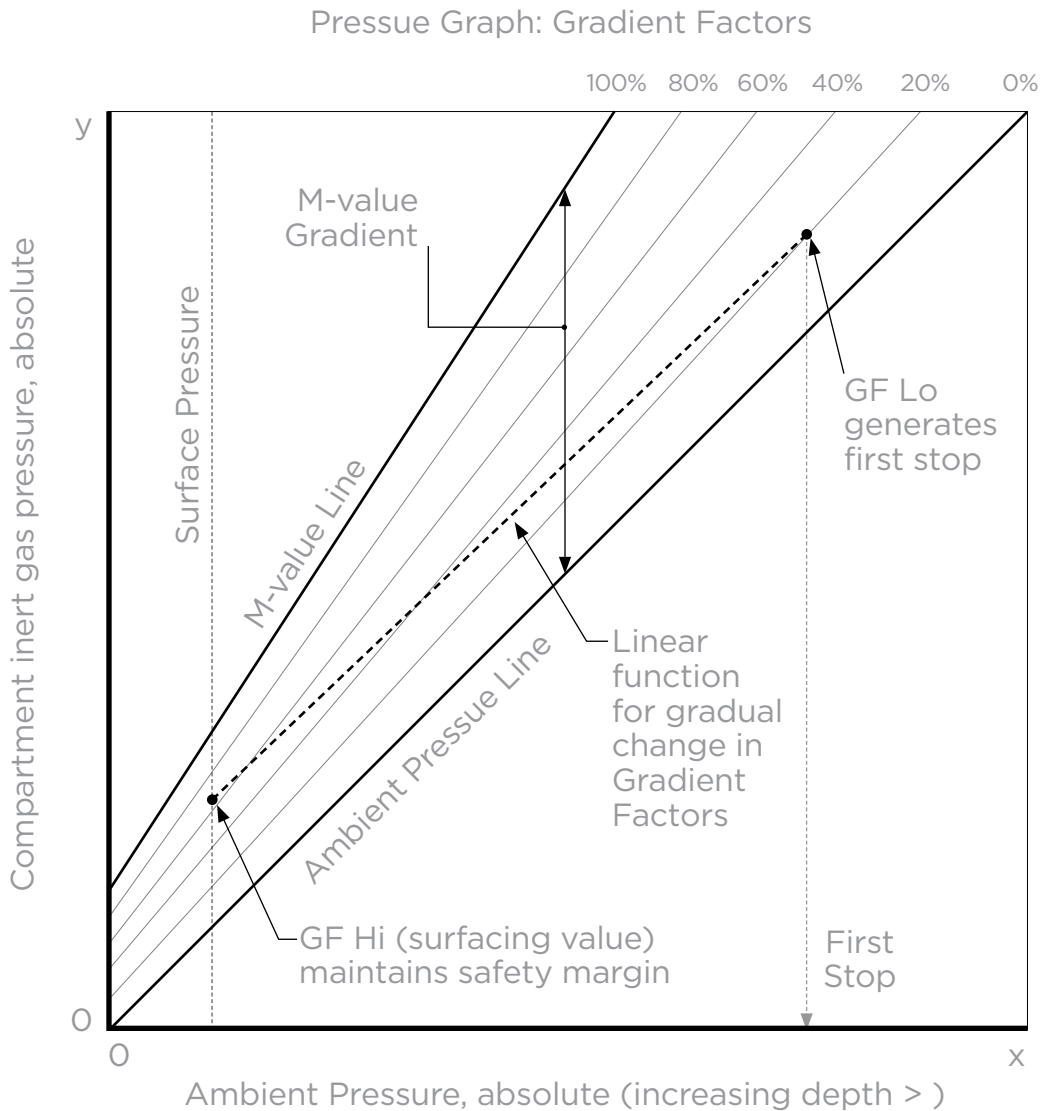

- A Gradient Factor is simply a decimal fraction (or percentage) of the M-value Gradient.
- Gradient Factors (GF) are defined from 0% to 100%.
- A Gradient Factor of 0% represents the ambient pressure line.
- A Gradient Factor of 100% represents the M-value line.
- Gradient Factors modify the original M-value equations for conservatism within the decompression zone.
- The lower Gradient Factor value (GF Lo) determines the depth of the first stop. Used to generate deep stops to the depth of the "deepest possible deco stop"
- The higher Gradient Factor value (GF Hi) determines the surfacing tissue supersaturation.

DECOMPRESSION INFORMATION ACCURACY

Decompression information displayed by this computer, including NDL, stop depth, stop time, and TTS are predictions. These values are continuously recalculated and will change with changing conditions. The accuracy of this information is dependent on several assumptions made by the decompression algorithm. It is important to understand these assumptions to ensure accurate decompression information.

It is assumed that the diver's ascent rate is 33ft/min. Ascending significantly faster or slower than this will impact decompression obligations. It is also assumed that the diver is carrying and plans to use every gas that is currently turned on. Leaving gasses that are not expected to be used turned on will result in inaccurate time to surface, decompression stop and decompression time information being displayed.

On ascent, it is assumed that the diver will perform decompression stops using the gas with the highest PPO₂ below the OC Deco PPO₂ value (default 1.61). If there is a better gas available, the current gas will be displayed in yellow, indicating that a gas change is expected. The decompression prediction displayed always assumes that the best gas will be used. Even if the switch to a better gas has not been completed yet, decompression predictions will be displayed as if the switch is about to occur in the next 5 seconds.

Divers can encounter longer than expected decompression stops as well as inaccurate time to surface predictions if they fail to switch to a better gas when prompted by the computer.

Example: A diver on a decompression dive to 40m/131ft for 40 minutes with GF settings of 45/85 has two gasses programmed into their computer and turned on: 21/00 & 99/00. The diver's decompression schedule will be calculated based on breathing 21% oxygen for the decent, bottom and ascent phases of the dive until the diver ascends to 6m/20ft. At 6m/20ft the PPO₂ of the 99/00 mix is 1.606 (less than 1.61), so it is the best decompression gas available.

Decompression information for the remaining stops will be calculated and displayed assuming the diver is going to switch to this better gas. This dive profile indicates these stops would be 8 minutes at 6m/20ft and 12 minutes at 3m/10ft. If the diver never makes the switch to 99/00, the computer will not allow them to surface until adequate off-gassing has occurred, but it will continue to assume the diver is about to make the gas switch and the decompression times given will be grossly inaccurate. The 6m/20ft stop will take 19 minutes to clear and the 3m/10ft stop will take 38 minutes to clear. That is a total time to surface difference of 37 minutes.

In a lost gas scenario or in the event a diver forgets to turn off a gas they are not carrying before a dive, gasses can be turned off during the dive in the Dive Setup -> Define Gas menu.

MENU STRUCTURE

The following sections show the menu structure in various operating modes.

OPEN CIRCUIT MENU STRUCTURE

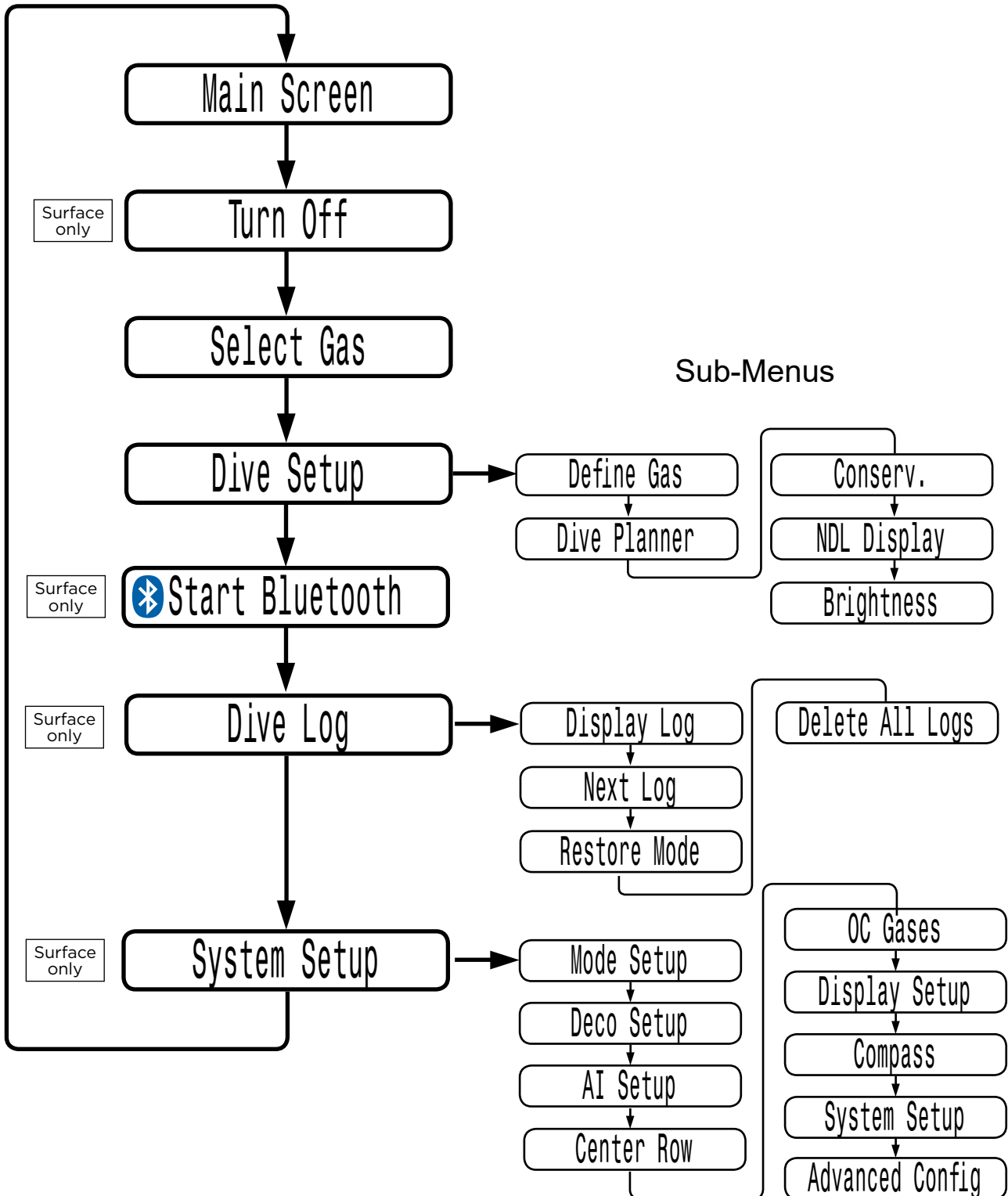

CLOSED CIRCUIT (INT. PPO2) MENU STRUCTURE

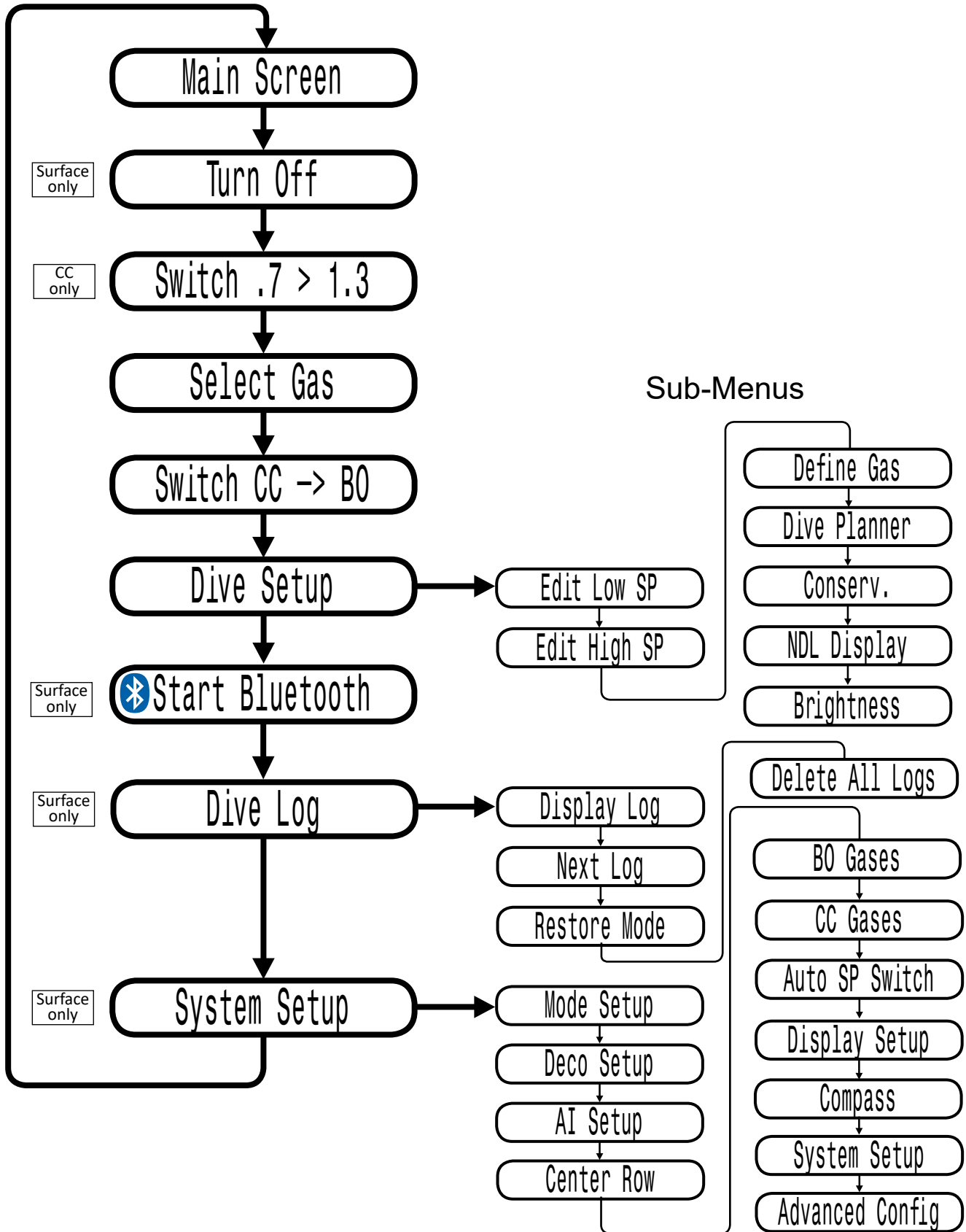

GAUGE MENU STRUCTURE

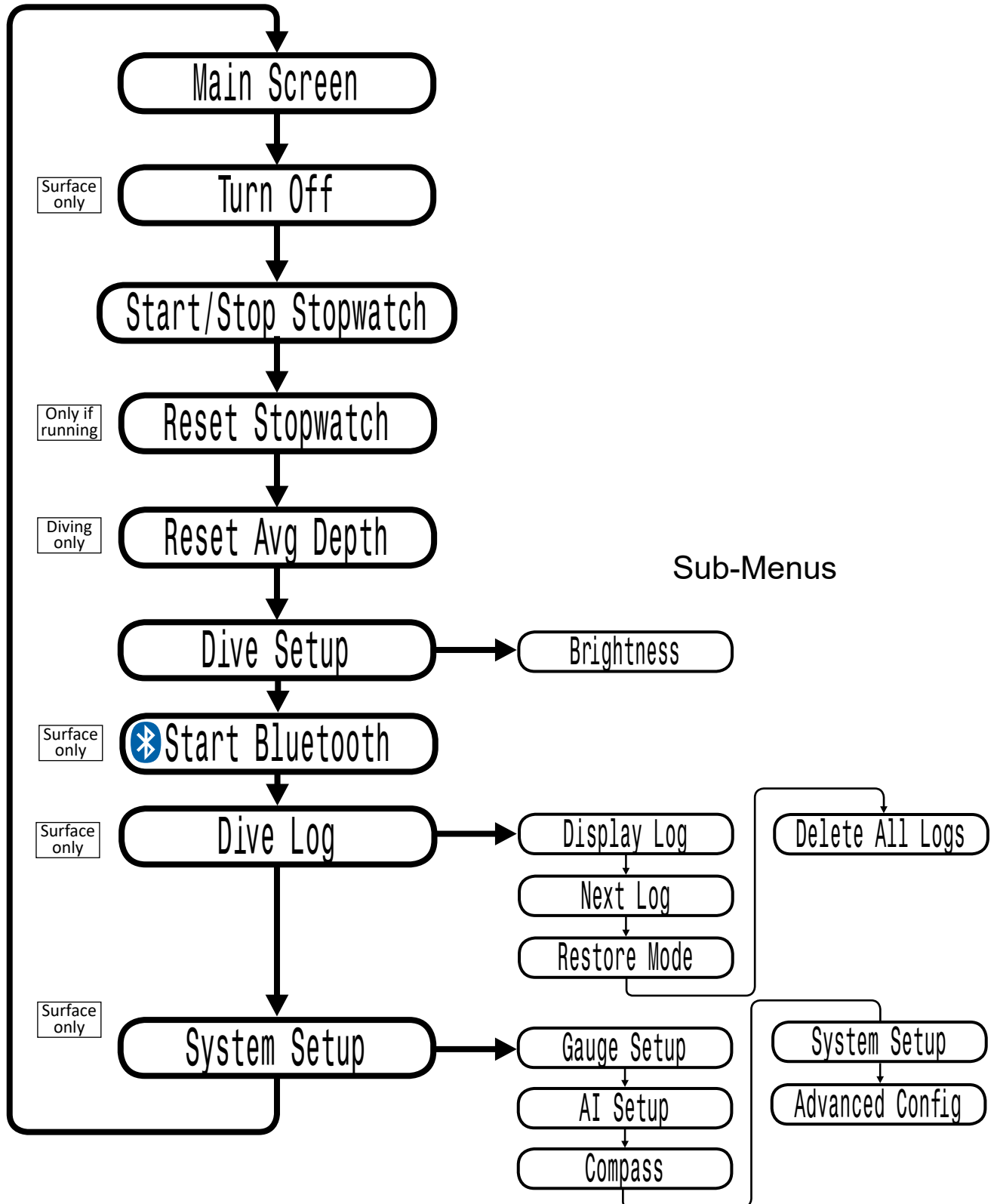

MENU REFERENCE

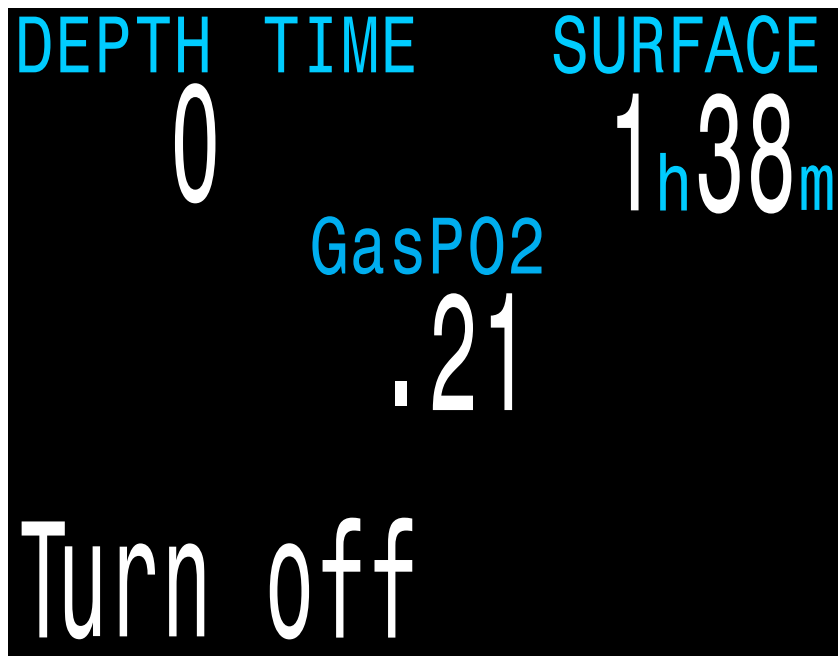

TURN OFF

The “Turn Off” item puts the computer to sleep. While sleeping, the screen is blank, but the tissue contents are maintained for repetitive diving. The “Turn Off” menu item will not appear during a dive on any model. It will also not appear after a dive until the End Dive Delay Time has expired to allow for a continuation dive.

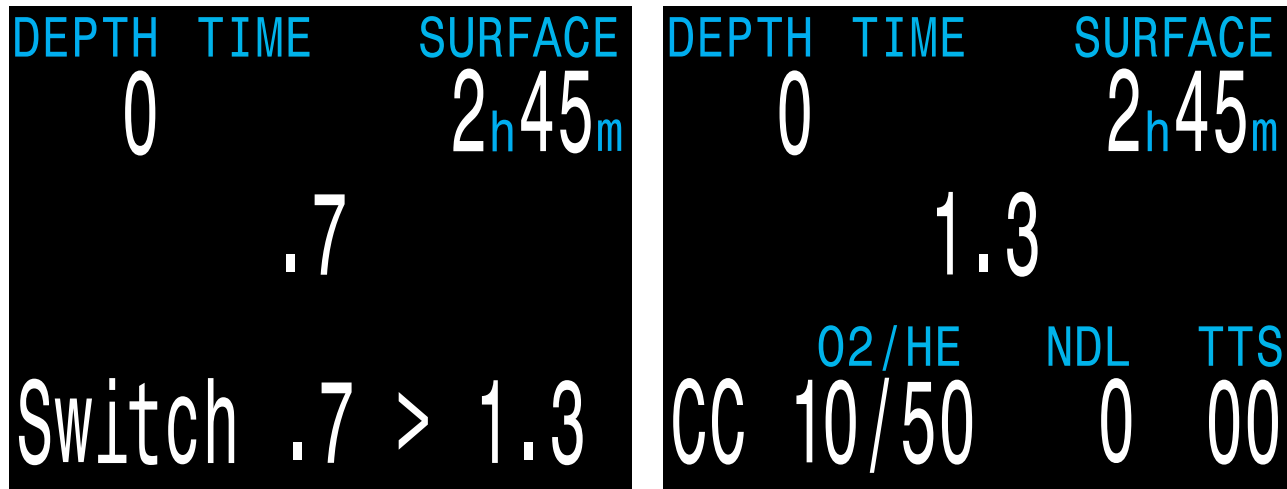

SWITCH SETPOINT

This menu is only available in CC mode.

The internal PPO2 mode is used to calculate decompression for an unconnected rebreather. In this case, the setpoints are switched in the computer to approximate the rebreather setpoint.

During a dive the “Switch Setpoint” menu item will be the first item displayed, since the “Turn Off” displays are disabled when diving.

Pressing SELECT when this menu is displayed changes the PPO2 setpoint from the low setpoint to the high setpoint or vice-versa. To redefine the PPO2 value of a setpoint, use the Dive Setup menu.

This menu item performs a manual switching of PPO2 setpoint. In the [System Setup](#) → [Auto SP Switch](#) menu, the Perdix can be setup to automatically perform setpoint switches at programmable depths. When auto setpoint switches are enabled, this menu item is still available to provide manual control.

SELECT GAS

This menu item allows you to pick a gas from the gases you have created. The selected gas will be used either as the breathing gas in open circuit mode, or the diluent in closed circuit mode.

Gases are always sorted from most to least oxygen content.

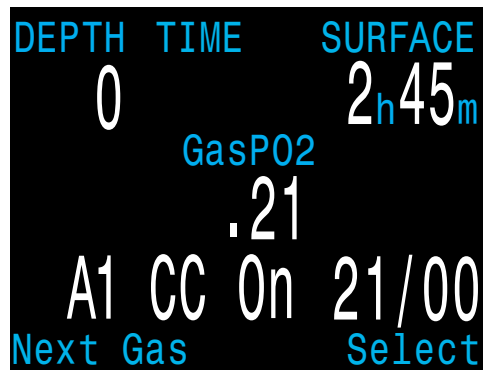
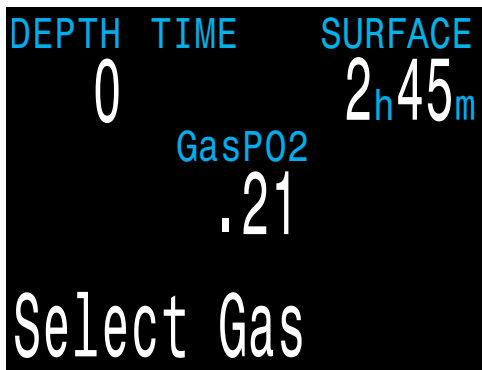

Use the MENU button to increment to the desired diluent/gas, then press the SELECT button to select that diluent/gas.

If you increment past the number of gases available, the display will fall back out of the “Select Gas” display without changing the selected gas.

An ‘A’ will appear next to the currently active gas.

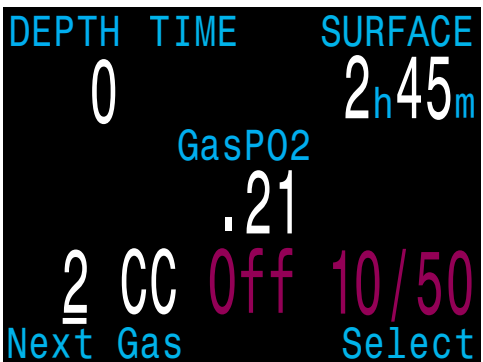
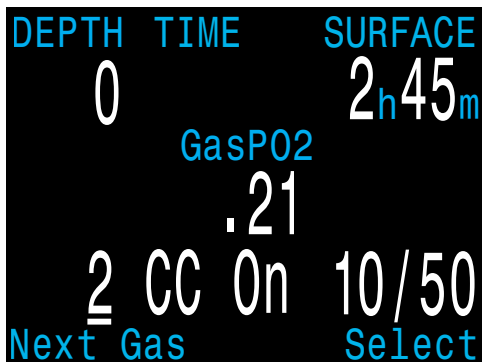

A gas that is off will be shown in **Magenta**, but can still be selected. It will be turned on automatically if it is selected. Off gases are not used in decompression calculations.

Watch the video:
[New Gas Select Style](#)



Radio Station Gases

For computer models that support open circuit and closed circuit operation, the system maintains two sets of gases - one for open circuit and one for closed circuit.

The way they operate is very similar to the way car radios work with AM and FM stations.

When you are listening to an FM station and you push a station selection button, it will take you to another FM station. If you add a new station, it will be an FM station.

Similarly, if you are in the AM mode, adding or deleting a station would add or delete an AM station.

With radio station gases, when you are in open circuit, adding, deleting or selecting a gas will refer to an open circuit gas. Just like the FM stations are selected when your radio is in FM mode, the closed circuit gases are available in the closed circuit mode. When you switch to open circuit, the gases available will be open circuit gases.

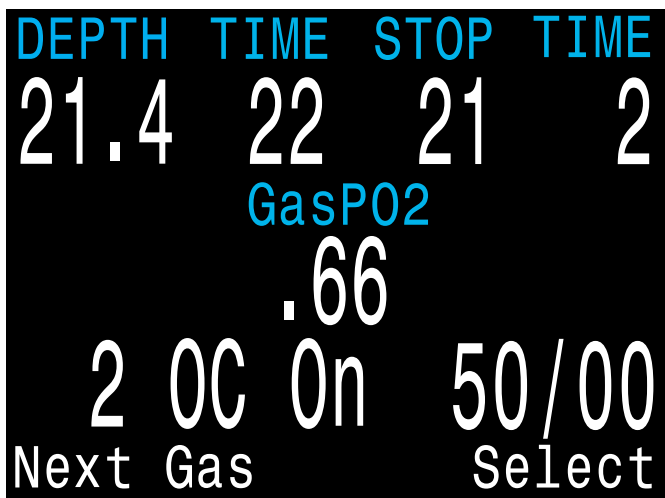
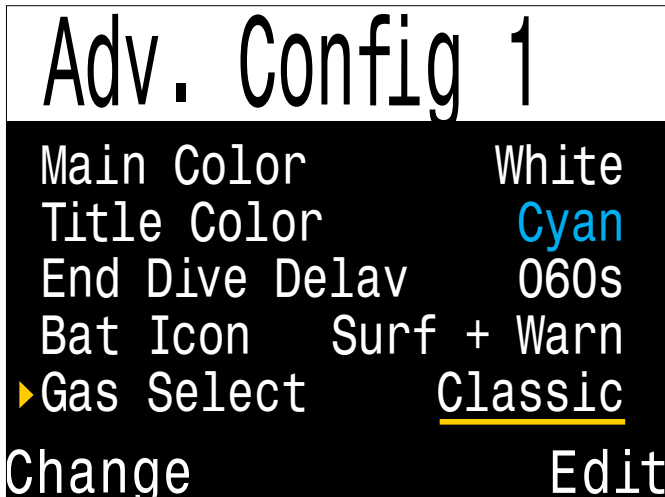

Classic Select Gas

Select Gas Menu Styles

Two styles of Select Gas menus are available, Classic and New.

Change between the two styles in the Adv. Config 1 menu.

Classic Style Select Gas

- The classic Select Gas style is as described on the previous page.
- One gas is shown at a time.
- Press MENU to step through gases, and SELECT to select the shown gas.
- Gases are sorted from highest O2% to lowest O2%.
- Stepping past the last gas will exit the menu without changing the active gas.
- Upon entering the Select Gas menu, the first gas shown is always the highest O2% gas.

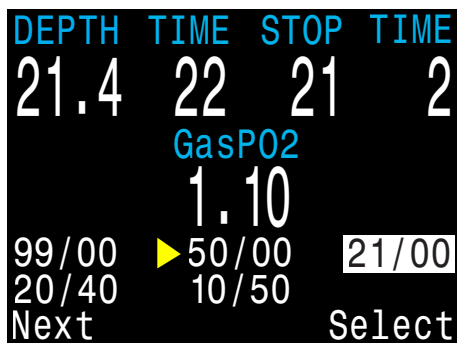

New Style Select Gas

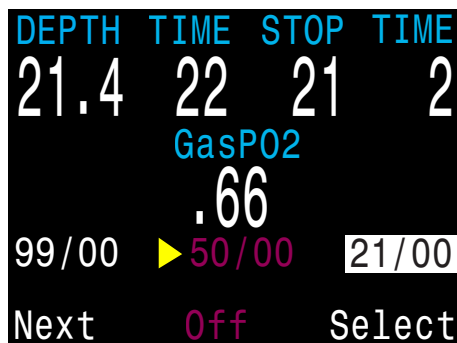

Off Gases are Magenta

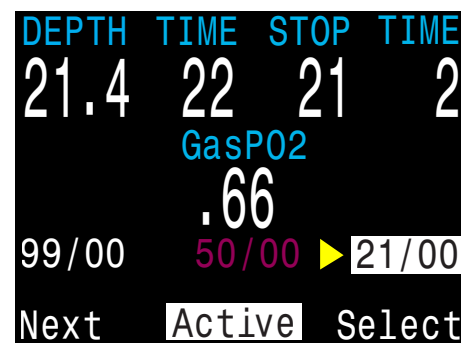

Active Gas is White

New Style Select Gas

The new style makes visualizing the gas list easier. It also reduces button presses for deco gas switches.

- Shows all gases on the screen at once.
- Press MENU to step through gases, and SELECT to select the pointed to gas.
- A gas must be selected to exit the menu (scrolling past last gas wraps back to first gas).
- The active gas is shown with a white background.
- Turned off gases are shown in **Magenta** (purple).
- Gases are sorted from highest O2% to lowest O2%.
- When diving and there is a deco stop, the first gas pointed to will be the most appropriate gas (highest PPO2 less than 1.61). This reduces button presses in most cases.
- On the surface or when no deco stops are needed, the first gas pointed to will be the active gas.

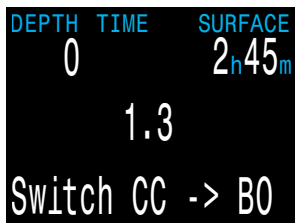

SWITCH TO CC/BO

Depending on the current computer setting, this selection will show as either “Switch CC > BO” or “Switch BO > CC”.

Pressing SELECT will select the displayed mode for decompression calculations. When switching to Bail Out while diving, the most appropriate Bail Out gas will become the breathing gas for calculations.

At this point, the diver may want to switch to a different gas, but since the diver may have other things to deal with, the computer will make a “best guess” of which gas the diver would choose.

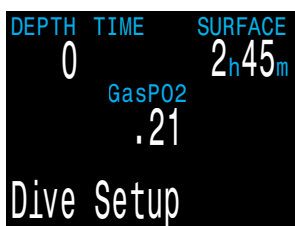
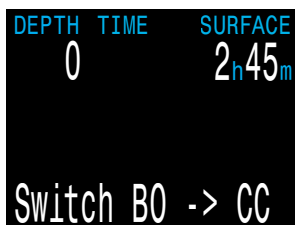

DIVE SETUP

The Dive Setup menus are available both on the surface and when diving.

The values in Dive Setup can also be accessed in the Systems Setup menu, but the System Setup menu is not available when diving.

Pressing SELECT will enter the Dive Setup sub-menu.

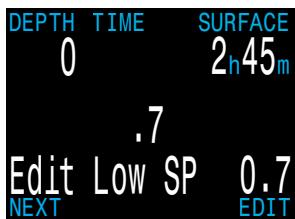

Low Setpoint CC/BO ONLY

This item allows you to set the low setpoint value. It will display the currently selected value. Values from 0.4 to 1.5 are allowed. A press of MENU will increment the setpoint.

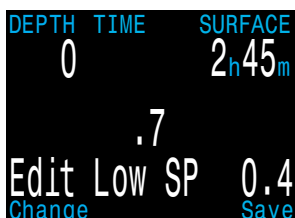

Press the SELECT button when “Edit Low SP” is displayed and the edit display will be shown. It is set at the lowest valid value for setpoint, .4.

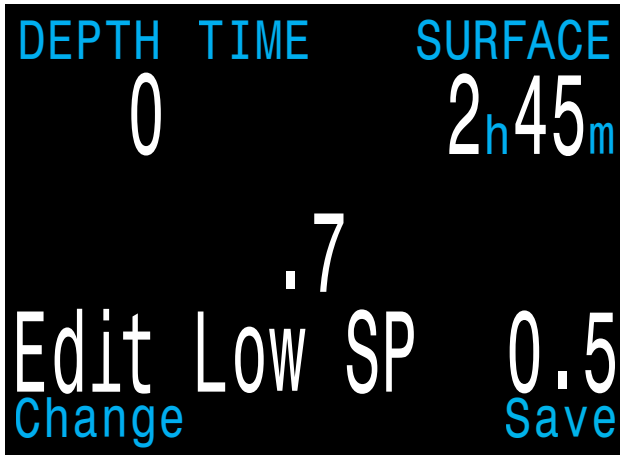

Another press of MENU will increment it again.

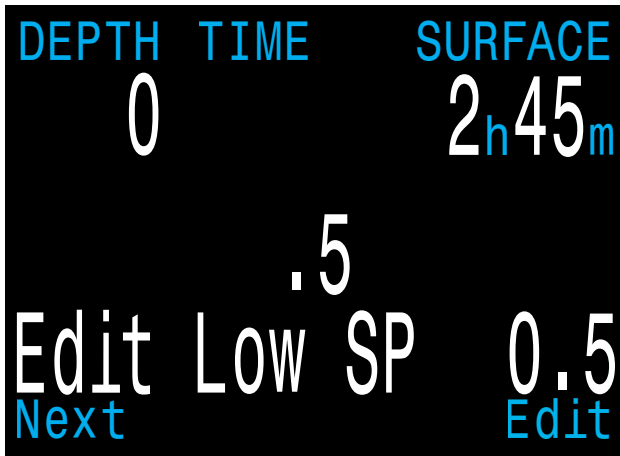

If SELECT is pushed, the currently displayed setpoint will be selected, and the display will return to the “Edit Low SP” menu item.

If the highest allowable value, 1.5, has been passed, the value will return to 0.4.

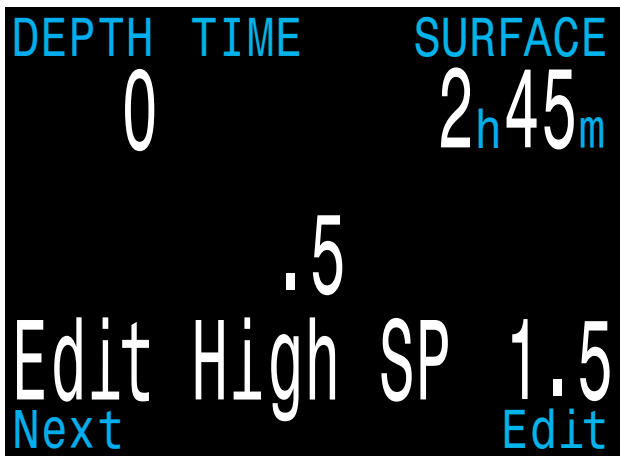

High Setpoint

The high setpoint function works exactly like the low setpoint function.

Define Gas

The define gas function allows you to set up 5 gases in Closed Circuit and 5 gases in Open Circuit. You must be in Open Circuit to edit open circuit gases, and you must be in Closed Circuit to edit closed circuit diluents. For each gas, you can select the percentage of oxygen and helium in the gas. The remainder is assumed to be nitrogen.

```
DEPTH  TIME  SURFACE
  0          2h45m
      GasPO2
      .21
Define Gas
Next      Define
```

Pushing SELECT when “Define Gas” is displayed presents the function to define gas number 1.

```
DEPTH  TIME  SURFACE
  0          2h45m
      GasPO2
      .21
  1 OC 0n  99/00
Next Gas      Edit
```

Pushing the MENU button will display the next gas.

```
DEPTH  TIME  SURFACE
  0          2h45m
      GasPO2
      .21
  2 OC 0n  50/00
Next Gas      Edit
```

Pushing SELECT will allow you to edit the current gas. The gas contents are edited one digit at a time. The underline will show you the digit being edited.

```
DEPTH  TIME  SURFACE
  0          2h45m
      GasPO2
      .21
  2 OC 0n  50/00
Change      Next
```

Each push of the MENU button will increment the digit being edited. When the digit reaches 9, it will roll over to 0.

```
DEPTH  TIME  SURFACE
  0          2h45m
      GasPO2
      .21
  2 OC 0n  50/00
Change      Next
```

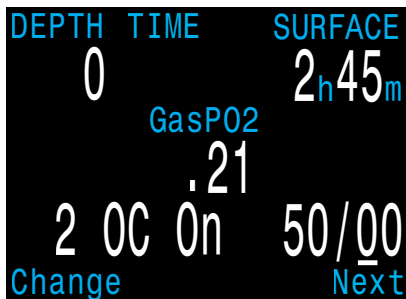

Pushing SELECT will lock in the current digit, and move on to the next digit.

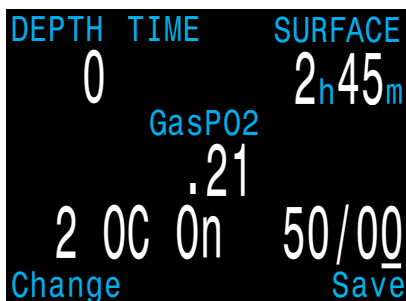

Pushing SELECT on the last digit will finish editing that gas, and bring you back to the gas number.

Any gases that have both oxygen and helium set to 00 will not be displayed in the “Select Gas” function.

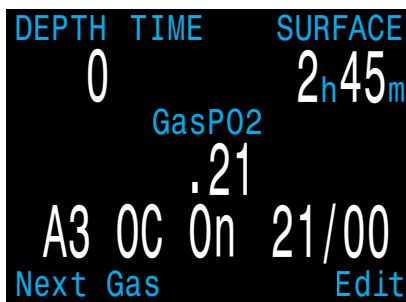

Pushing MENU will continue to increment the gas number.

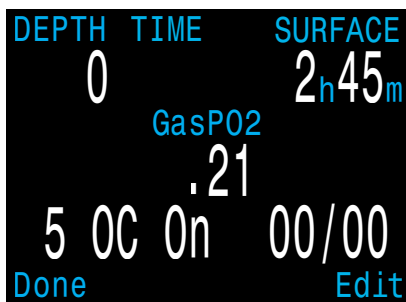

Note: The “A” denotes the active gas. You cannot delete the active gas. If you try, it will generate an error. You can edit it, but cannot set both the O2 and HE to 00.

The computer will display all 5 gas entries available to allow you to enter new gases.

Pressing MENU one more time when the fifth gas is displayed will return you to the “Define Gas” menu item.



WARNING

ONLY TURN-ON GASES YOU ARE CARRYING

Only turn on the gases you are actually carrying and plan to use on the dive. **Failure to abide by this warning may result in inaccurate decompression information being displayed.**

With radio station gases, the computer has a full picture of the OC and CC gases you are carrying and can make informed predictions about decompression times. There is no need to turn gases off and on when you switch from CC to OC, because the computer already knows what the gas sets are. You should only have the CC and OC gases you are actually carrying turned on.

If you often use other gases, you can enter the gas and turn it off. You can turn gases on and off during a dive and you can also add or remove a gas during the dive if needed.

Dive Planner

Introduction

- Calculates decompression profiles for simple dives.
- In closed-circuit (CC) mode, also calculates open-circuit (OC) bail-out (BO).

Setup

Uses the current gases programmed into the Perdix, as well as the current GF low/high settings. VPM-B dive planning is available on units with the optional VPM-B unlock. Deco profile is computed for the current circuit mode (CC or OC).

On the surface

Enter the dive bottom depth, bottom time, respiratory minute volume (RMV) and PPO2 (closed-circuit only).

Note: Residual tissue loading (and CNS%) from recent dives will be used in calculating the profile.

CC	Depth	Time	RMV	P02
	150	030	.25	1.3
Enter Bottom Time in minutes				
Min: 5				
Max: 180				
Change			Next	

During a dive

Computes the decompression profile assuming the ascent will begin immediately. There are no settings to enter. (RMV is last used value)

Dive Plan Setup

Limitations

The Perdix Dive Planner is intended for simple dives. Multi-level dives are not supported.

The Perdix Dive Planner makes the following assumptions:

- Descent rate is 60ft/min (18m/min) and the ascent rate is 33ft/min (10m/min).
- For OC, the gas in use will be the gas with the highest PPO2 less than 1.40 for the bottom gas, and 1.61 for deco gases (the deco gas max PPO2 can be changed in the Adv Config 1 menu).
- For CC, the diluent in use will be the gas with the highest PPO2 less than 1.05.
- The planner will use the configured last stop depth.
- For CC, the PPO2 is constant for the entire dive.
- The RMV is the same while diving as during deco.

The Dive Planner does not provide thorough validation of the profile. For example, it does not check for nitrogen narcosis limitations, gas usage limitations, CNS percentage violations, or isobaric counter-diffusion risks due to sudden helium switches. The user is responsible for ensuring a safe profile is followed.

Result screens

The results are given in tables showing:

- Stp: Stop Depth In feet (or meters)
- Tme: Stop Time In minutes
- Run: Run Time In minutes
- Qty: Gas Quantity in CuFt (or liters). OC and BO only

The first few rows will show the bottom time (bot) and the ascent legs (asc) to ascend to the first stop. Multiple ascent legs may be shown if gas switches are needed.

CC				
Depth	Time	RMV	P02	
150	030	.55	1.3	
Stp	Tme	Run	Gas	
150	bot	30	10/50	
70	asc	32	10/50	
70	1	33	10/50	
60	2	35	10/50	
50	1	36	10/50	
Quit			Next	

BO					
Depth	Time	RMV	P02		
150	030	.55	1.3		
Stp	Tme	Run	Gas	Qty	
30	5	43	36/00	6	
20	6	49	99/00	6	
10	11	60	99/00	8	
Quit			Next		

Example Results Table for Closed-Circuit and Bailout.

If more than 5 stops are needed, the results will be split onto on several screens. Use the right button to step through the screens.

For OC or BO profiles, a total gas consumption report is given.

BO				
Depth	Time	RMV	P02	
150	030	.55	1.3	
Gas Usage. In CuFt				
99/00:		14		
36/00:		14		
21/25:		7		
12/50:		0		
Quit			Next	

Gas Usage Report

The final result screen shows the total dive time, the time spent on deco and final CNS%.

```

CC Depth Time RMV P02
  150  030  .55  1.3
-----
CC Summary
Run:   61 minutes
Deco:  31 minutes
CNS:   34%
-----
Quit           Plan B0
    
```

Results Summary Screen

If no decompression is required, no table will be shown. Instead, the total No-Decompression-Limit (NDL) time in minutes, at the given bottom depth will be reported. Also, the gas quantity required to surface (bailout in CC) will be reported.

```

CC Depth Time RMV P02
  150  030  .55  1.3
-----
No Deco Stops.
Total NDL at 80ft
is 47 minutes
Bailout gas quantity
is 4 CuFt.
-----
Quit           Done
    
```

No Decompression Results Screen

Conservatism

The conservatism settings (GF High and GF Low) can be edited in the Dive Setup menu. While diving, only the GH High value can be edited. This allows changing the surfacing conservatism during a dive. For example, if you worked much harder on the bottom segment than expected, you may wish to add conservatism by reducing the GF High setting

```

DEPTH TIME STOP TIME
  0
.85 .7 .84
Conserv 30/70
Next           Edit
    
```



NDL Display

The NDL Display option allows you to display four different values during the dive. The display can be changed during the dive to provide different information. The value selected here replaces the NDL on the main screen once decompression stops are required.

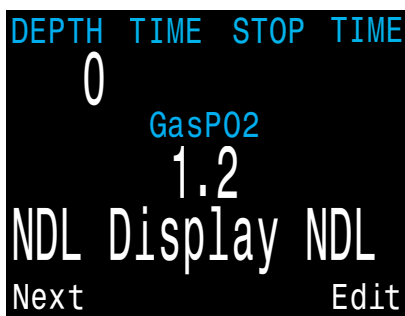
- 1 NDL
- 2 CEIL
- 3 Buhlmann
- 4 @+5
- 5 Δ+5

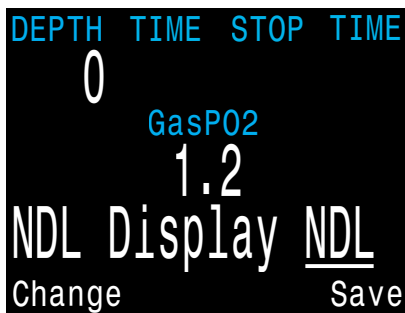

1 Pushing SELECT will make the NDL display editable. The first choice available will be **NDL**. If you select NDL, the NDL will always be displayed during the dive whether or not you have a decompression ceiling.



2 The next selection is **CEIL**. With this setting, as long as the NDL time is 0 (you have a decompression ceiling), the raw ceiling will be displayed instead of the NDL. This is the equivalent of the 'Man on a rope'. It will show your ceiling without it being rounded up to the next even 10 foot or 3 meter stop. Please note that there is very limited information on the effects of following a continuous ceiling instead of stopping at stops and only moving up to the next stop when the stop has cleared.

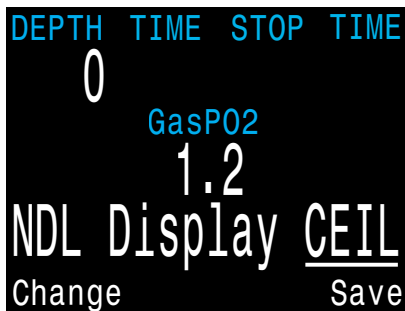

It is the Shearwater's opinion that all stops should be honored. It seems intuitive that if you have bubbles, and you stop, you give the bubbles an opportunity to be resorbed. If you continuously ascend, the ambient pressure is continuously reduced which prevents bubbles from shrinking. Because of this belief, the computer will give one **MISSED DECO STOP** message during the dive and one after the dive, and will flash the stop depth and time in **red** as long as you are above the stop depth. It will use the increased gradient though, and your calculated off-gassing will be faster than staying at the stops.

```

DEPTH TIME STOP TIME
0
GasPO2
1.2
NDL Display GF99
Change Save
    
```

```

DEPTH TIME STOP TIME
34.7 15 24 1
GasPO2
1.2
02/HE GF99 TTS
CC 10/50 12 42
    
```

- 3 The next option is to display the actual supersaturation gradient for a pure Bühlmann (99/99) profile.

The selection is **GF99**. With this setting, as long as the NDL time is 0 (you have a decompression ceiling), the gradient will be displayed instead of the NDL.

The number shown is the percentage of supersaturation. The number is calculated by reference to the Ambient Pressure Line and the M-Value line. It can be thought of as the current GF, but it is different in a couple of ways. First, the current GF generates stops rounded to the nearest 10 feet or 3 meters. So a gradient of 40 may reflect a ceiling of 15 feet, but the computer will show a rounded-up 20 foot stop.

This number can be used in several ways. First, it can be used to calculate an aggressive ascent that still has some justification in decompression science. For example, if a diver were to lose a significant portion of their gas and needed to get shallow fast, they could ascend until they reached a gradient of 90, then stop until it dropped to 80, then ascend to 90 again, etc. That would produce a Bühlmann-like profile with very little conservatism. In an emergency, that may be an acceptable risk.

Another use might be to do a slower ascent on a dive to sightsee, but to stay in the decompression zone by keeping the gradient above 0.

Another use would be to observe the rapidly increasing gradient in the last 10 feet to the surface and slow that ascent.

All of this is based on gradient theory that may be completely false. There is significant disagreement in the decompression research community about the nature and practice of decompression. Any techniques described here should be considered experimental, but the concepts may be useful to the advanced diver.

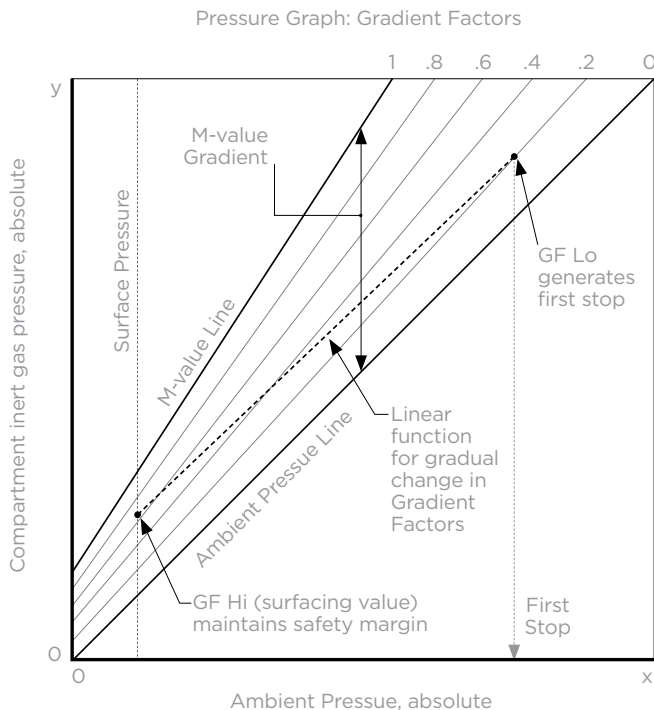

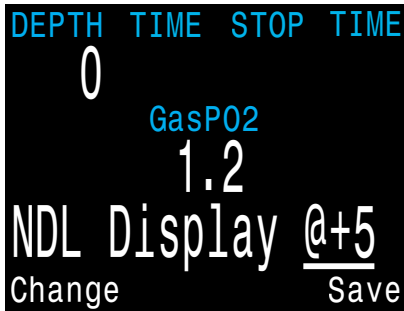

- 4 The last selection is **@+5**. This feature was inspired by Dan Wible's CCR2000 computer (Thanks Dan!) It is the time-to-surface (TTS) if you were to stay at the current depth for five more minutes. This can be used as a measure of how much you are on-gassing or off-gassing.

For example, on a dive on a wreck, you go to the bottom until you accumulate the desired decompression and TTS. After ascending to the second deck, you notice that the **@+5** and TTS are the same. That means that you can spend 5 minutes exploring this deck without incurring more decompression.

Once you get to the top deck, the current has picked up. The line runs from the top of the deck to the surface which is a distance of 30 feet/10 m. You see that your **@+5** is 11 minutes and your TTS is 15 minutes. That means that you can stay down out of the current for 5 minutes and burn off about 4 minutes of deco. You may decide to accept the 80% decompression efficiency and stay out of the current.

When your TTS is 10 minutes, you see that your **@+5** is 9 minutes. Since the decompression is not very efficient now, you go up the line and spend the last 10 minutes in the current.

When your TTS is 10 minutes, you see that your **@+5** is 9 minutes. Since the decompression is not very efficient now, you go up the line and spend the last 10 minutes in the current.

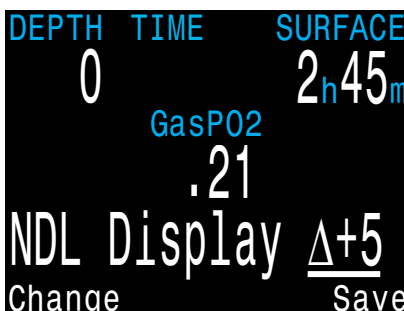

- 5 The last selection option is **Δ+5**. This feature is an expansion on **@+5** where the value displayed is the difference between **@+5** and TTS. This value lets you know at a glance if you are on-gassing or off-gassing without having to compare TTS and **@+5** directly.

If you are on-gassing, **Δ+5** will show a positive time in minutes. If you are off-gassing, **Δ+5** will show a negative time in minutes. This will give you a quick real-time indication of how your decompression schedule is changing.

Brightness



The display brightness has four fixed brightness settings plus an Auto mode.

The fixed options are:

- 🔦 **Cave:** Longest battery life.
- 🔦 **Low:** Second longest battery life.
- 🔦 **Med:** Best mix of battery life and readability.
- 🔦 **High:** Easiest readability, especially in bright sunlight.

Auto will use the light sensor to determine the brightness of the display. The more ambient light there is, the brighter the display will get. At depth, or in dark water, very little brightness is needed to see the display.

The Auto setting works well in most situations.

The brightness of the display is the major determinant of battery life. Up to 80% of the power consumption is to power the display. When a low battery alert occurs, the display brightness is automatically reduced to extend battery life.

DIVE LOG MENU

Display Log

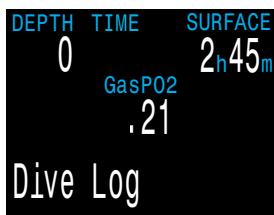

At the “Display Log” prompt, press SELECT to view the most recent dive.

The profile of the dive is plotted in blue, with decompression stops plotted in red. The following information is displayed:



- Maximum and Average depth
- Dive number
- Date (dd/mon/yyyy)
- Start - Time of day dive started
- End - Time of day dive ended
- Length of dive in minutes
- Minimum, maximum, and average temperature
- Dive mode (OC Tec, CC/BO, etc.)
- Surface interval preceding the dive
- Recorded Surface Pressure at the beginning of the dive
- Deco model and gradient factor settings used
- Start and end CNS
- Starting and ending tank pressure (Perdix AI only)
- Average SAC (Perdix AI only)

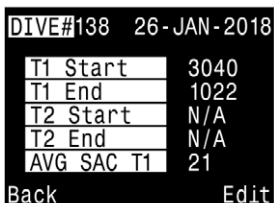
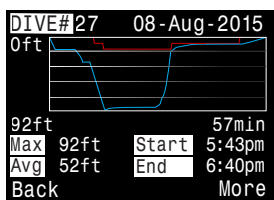

Press MENU to see the next dive, or SELECT to quit viewing logs. Press Back to see the list of dive logs, and next to select the next dive and View.

Edit Log Number

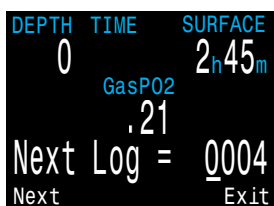

The dive log number can be edited. This is useful if you want the Perdix log numbers to match your lifetime dive count.

At the “Next Log” prompt, press SELECT to begin editing. While editing, use MENU to change the value of the currently underlined digit, and SELECT to move to the next digit.

This number will be applied to the next dive.

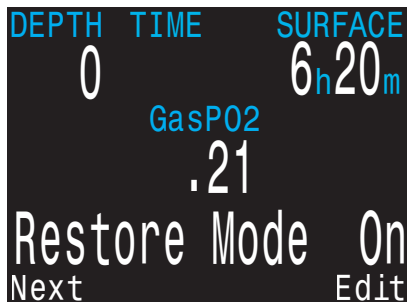

Restore Mode

Restore mode can be toggled on and off. When toggled on, it shows deleted logs, greyed out in the "Display Log" sub-menu. These dives can be restored to the Dive Log.

The Delete All Logs option is also changed to Restore All Logs when Restore mode is enabled.

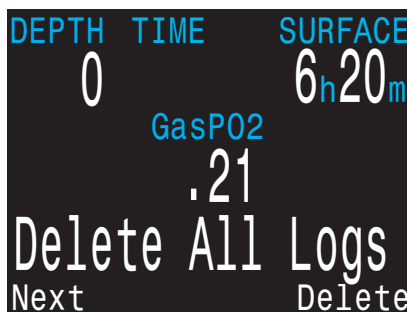

Delete All Logs

Deletes All of the Logs.

Deleted Logs can be restored by toggling Restore Mode to on.

See the Dive Log functionality demonstrated on a Shearwater Petrel here:



SYSTEM SETUP

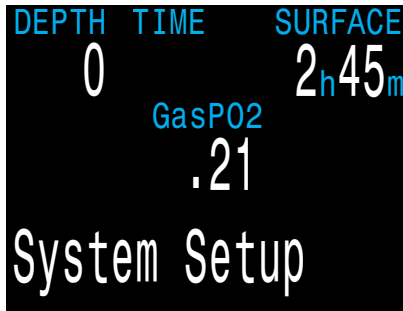

System Setup contains configuration settings together in a convenient format for updating the configuration before a dive.

System setup cannot be accessed during a dive.

However, many of the settings are also available during the dive in a single line interface. Although all of the settings available in Dive Setup are available in System Setup, not all settings in System Setup can be edited in Dive Setup.

The MENU and SELECT buttons are context sensitive to each sub menu and individual setting.

Example Menu		Example Menu	
▶ Example	0.00	▶ Example	<u>0</u> .00
Example	0.00	Example	0.00
Example	0.00	Example	0.00
Example	0.00	Example	0.00
Example	0.00	Example	0.00
Next	Edit	Change	Next

When cycling through the sub-menus, MENU will carry the user to the next sub-menu, while SELECT will allow the user to edit the options in this submenu.

Once the user has pressed SELECT to edit a submenu, MENU will cycle the user through the different submenu listings, while SELECT will let the user edit those listings.

Once the user has pressed SELECT to edit a submenu listing MENU will be used to change the context sensitive variable, while the SELECT button will be used to move to the next field. Once the user has pressed SELECT through all the fields, the new user preferences will be saved.





Mode Setup

The first submenu of System Setup+ is Mode Setup.

Mode Setup	
Mode	CC/BO
Salinity	Fresh
PP02 Mode	Int.
Low SP	0.7
High SP	1.3
Next	Edit

Mode



Mode sets which breathing circuit configurations are available:

-  CC/BO
-  OC Tec
-  OC Rec (default)
-  Gauge (e.g. bottom timer mode)

When changing to or from Gauge mode, the decompression tissues are cleared. This is because when in Gauge mode the Perdix does not know what gas you are breathing, , and therefore cannot track inert gas loading.

Salinity

Water type (salinity) affects how the measured pressure is converted to depth. Settings:

-  Fresh
-  EN13319
-  Salt

Density of freshwater and saltwater differ by about 3%. Saltwater, being denser, will display a shallower depth for the same measured pressure versus the Fresh setting.

The EN13319 value is between Fresh and Salt. It is from the European CE standard for dive computers, and is the Perdix's default value.

PPO2 Mode

▶ Mode Setup	
Mode	OC/CC
Salinity	Salt
PPO2 Mode	Int.
Low SP	0.7
High SP	1.3
Next	Edit

PPO2 mode is only set when CC is enabled.

On the Perdix this value is always Int (internal fixed PPO2).

Low and High Setpoints

The Low and High PPO2 Setpoints are only available when CC is enabled.

Each setpoint can be set from 0.4 to 1.5.

The setpoints can also be edited during a dive, in the Dive Setup menu.

Deco Setup

▶ Deco Setup	
Deco Model	GF
Conserv (GF)	30/70
Last Stop	6m
NDL Display	CEIL
Next	Edit

Deco Model

May just show Bühlmann ZHL-16 with gradient factors model, or it may allow you to switch between GF and various types of VPM-B. The choices will be available if you have unlocked VPM-B.

Conservatism

Can be adjusted in either the GF or VPM model. For a more detailed explanation of their meaning for the GF algorithm, please refer to Erik Baker's excellent articles: **Clearing Up The Confusion About "Deep Stops"** and **Understanding M-values**. The articles are readily available on the web. VPM-B has conservatism settings from 0 to +5, with higher numbers being more conservative.

Last Stop

Allows you to choose where to do your last stop. The choices are 10ft/3m and 20ft/6m. Note that this setting does not affect decompression. It only makes the TTS prediction more accurate.

NDL Display

These options were previously covered in the Dive Setup+ section.

▶ OC Gases		
1 OC	On	21/00
2 OC	Off	00/00
3 OC	Off	00/00
4 OC	Off	00/00
5 OC	Off	00/00
Next	Edit	

OC Gases

The next submenu is OC Gases. This menu allows the user to edit the open circuit gases. The options contained here are the same as those in the "Define Gases" subsection of the "Dive Setup" section contained earlier in this manual. This menu page conveniently displays all five gases simultaneously.

For a description of how to appropriately set each gas, please see the earlier Define Gas section

▶ CC Gases		
A1 CC	On	21/00
2 CC	Off	00/00
3 CC	Off	00/00
4 CC	Off	00/00
5 CC	Off	00/00
Next	Edit	

CC Gases

The next submenu is CC Gases. This menu allows the user to edit the closed circuit diluent gases. The options contained here are the same as those in the "Define Gases" subsection of the "Dive Setup" section contained earlier in this manual. This menu page conveniently displays all five gases simultaneously.

For a description of how to appropriately set each gas, please see the earlier Define Gas section.

```

▶Auto SP Switch
Up:    0.7>1.3  Auto
Up Depth  070ft

Down:   1.3>0.7  Auto
Down Depth 040ft
Next      Edit
    
```

Auto SP (Setpoint) Switch

This menu page is only available in CC mode when PPO2 mode is set to internal (see Dive Setup page).

Auto Setpoint Switch configuration sets up the setpoint switching. It can be set up to auto switch up only, down only, both, or neither.

First, you set whether the “Up” switch occurs automatically or manually. If “Up” is set to “Auto”, then you can set the depth at which the auto switch occurs.

The menu options are the same for the down setpoint switch.

Example:

Up: 0.7 > 1.3 = Auto, Up Depth = 70 ft.
 Down: 1.3 > 0.7 = Auto, Down Depth = 41ft

The dives starts at the 0.7 setpoint. As you descend past 70ft, the setpoint switches “up” to 1.3.

You finish your bottom time, then begin ascending. When you ascend above 41ft, it switches “down” to 0.7.

When a switch is set to “Auto”, you can always manually override the setting at any time during the dive.

The automatic switches only occur when crossing the specified depth. Say for example, the switch up depth is set to 50ft. You start the dive on the low setpoint, then as you descend past 50ft, the setpoint automatically switches up to high. If at say 80ft you then manually switch back to the low setpoint, the setpoint will remain low. If you ascend shallower than 50ft then re-descend deeper than 50ft again, the automatic setpoint switch will occur again. The Perdix enforces a 20ft (6m) gap between switch up and switch down depths to prevent rapid automatic switching between setpoints for small depth changes. The values 0.7 and 1.3 are shown as examples only. Other values for the low and high setpoint can be adjusted in the Dive Setup menu.

```

Auto SP Switch
Up:    0.7>1.3  Auto
▶Up Depth  070ft

Down:   1.3>0.7  Auto
Down Depth 041ft
Change      Next
    
```

```

Auto SP Switch
Up:    0.7>1.3  Auto
Up Depth  070ft

▶Down: 1.3>0.7  Manual
Change      Save
    
```

Display Setup

Display Setup	
▶Depth Units	Feet
Temp Units	°C
Brightness	Med
Altitude	SeaLvl
Flip Screen	
Next	Edit

Depth and temperature units can be set independently.

Depth Units

Two options are available:

Feet: Imperial units

Meters: Metric units

Temp Units

Two options are available:

°F: Imperial units

°C: Metric units

Display Setup	
Depth Units	Feet
Temp Units	°C
▶Brightness	Med
Altitude	SeaLvl
Flip Screen	
Change	Save

Brightness

Screen brightness can be set to fixed levels or an automatic setting.

Fixed options:

Cave: Made specifically for cave conditions. Longest battery life.

Low: Second longest battery life.

Med: Best mix of battery life and readability.

High: Easiest readability, especially in bright sunlight.

The “Auto” option measures ambient light levels and then adjusts the screen brightness to best performance. It provides maximum brightness in bright sunlight, but then lowers brightness to save battery life when the environment gets darker.

Altitude

The altitude setting when set to 'Auto' will compensate for pressure changes when diving at altitude. If all your diving is at sea level, then setting this to 'SeaLvl' will assume that surface pressure is always 1013 mBar (1 atmosphere).

Display Setup		Display Setup	
Depth Units	Feet	Depth Units	Feet
Temp Units	°C	Depth Temp	°C
Brightness	Med	Brightness	Med
▶Altitude	<u>Auto</u>	▶Altitude	<u>SeaLvl</u>
Flip Screen		Flip Screen	
Change	Save	Change	Save

If the Perdix measures the surface pressure to be less than 965 mbar, then the Altitude setting will be forced to "Auto" and cannot be changed.



DETERMINATION OF SURFACE PRESSURE

Accurate depth measurements and decompression calculations require knowing the ambient atmospheric pressure at the surface. Regardless of the turn on method, the surface pressure is determined the same way. While in the off state the surface pressure is measured and saved every 15 seconds. A 10 minute history of these pressure samples is kept. Immediately after turn-on this history is examined and the minimum pressure is used as the surface pressure. The surface pressure is then remembered, and not updated again until the next turn-on.

Flip Screen

This function displays the contents of the screen upside down.

The Flip Screen is of limited use on the Perdix model, but can be used if you wish to wear the Perdix such that the buttons are on the top of the device.

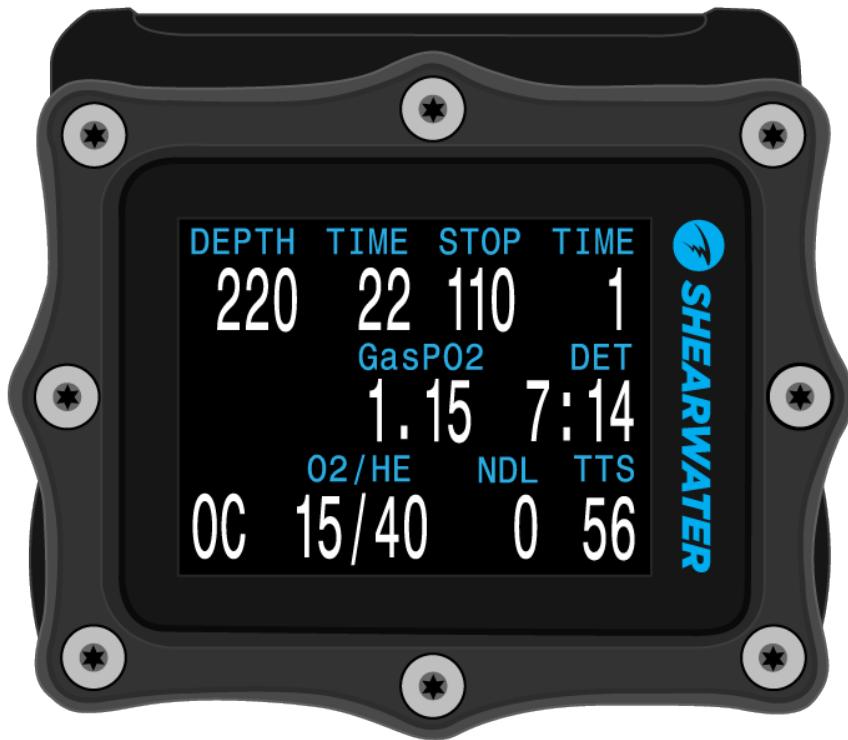
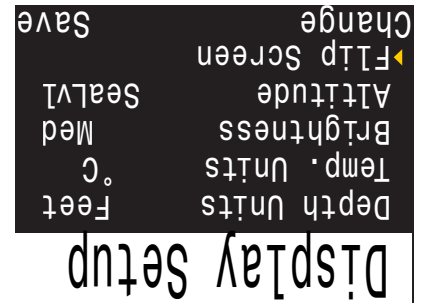

In the normal orientation, buttons are at the bottom of the display. If you flip the display, the buttons will be up top when the Perdix is worn on the wrist.

Compass Setup

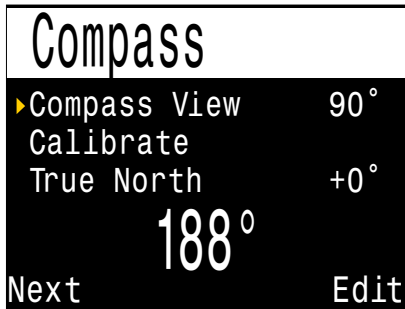

Compass View

The Compass View setting can be set to:

- Off: The compass is disabled.
- 60°, 90°, or 120°: Sets the range of the compass dial that is visible on the main screen. The actual amount of arc that there is room for on the screen is 60°, so this may feel the most natural. The 90° and 120° settings allow a wider range to be seen at once. The default is 90°.

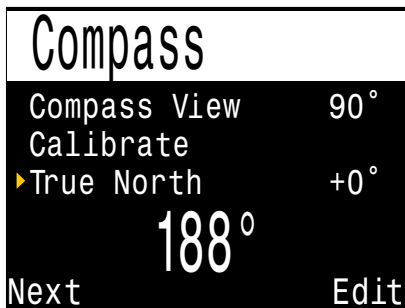

True North

In most places, a compass does not point towards True North, but rather to Magnetic North. The difference in angle between these two directions is called the magnetic declination (also called magnetic variation), and varies around the world. The declination in your location can be found on maps or by searching online.

This setting can be set from -99° to +99°.

If you only need to match an uncompensated compass, or your navigation is all based on relative directions, then this setting is not necessary and can be left at 0°.

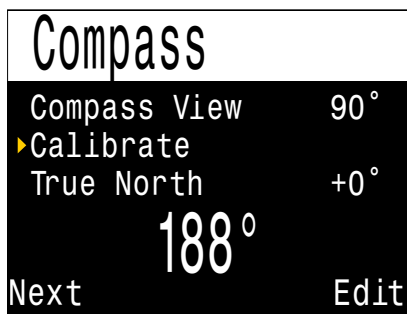

Calibrate

Calibration of the compass may be needed if the accuracy drifts over time or if a permanent magnet or ferromagnetic metal (e.g. iron or nickel) object is mounted very close to the Perdix. To be calibrated out, such an object must be mounted with the Perdix so that it moves along with the Perdix.



BATTERY AFFECTS THE COMPASS CALIBRATION

Each battery has its own magnetic signature, mostly due to its steel case. Therefore, recalibrating the compass when changing the battery is recommended.

Compare the Perdix with a known good compass or fixed references to determine if calibration is needed. If comparing against fixed references, remember to consider the local deviation between Magnetic North and True North (declination).

Calibration is typically not needed when travelling to different locations. The adjustment needed then is the True North (declination).

When calibrating, rotate the Perdix smoothly through as many 3D twists and turns as possible in 15 seconds. Keep metal and magnetic objects away during calibration. The calibration can also be reset back to the factory values. After calibration, it is recommended to compare the compass accuracy with a known good compass or fixed references



TIPS FOR A GOOD COMPASS CALIBRATION

- Stay away from metal objects. For example, wrist watches, metal desks, boat decks, desktop computers, etc. can all interfere with the Earth's magnetic field.
- Rotate to as many 3D positions as possible. Upside down, sideways, on edge, etc.
- Compare with another compass (not a smartphone as those are terrible) to check your calibration.

System Setup

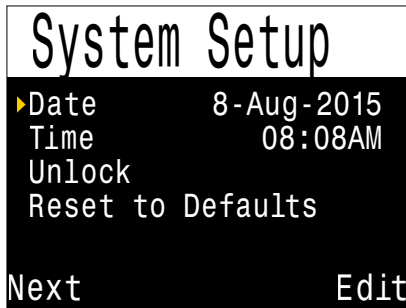

Date

The first 'System Setup' changeable option is 'Date,' which allows the user to set the current date.

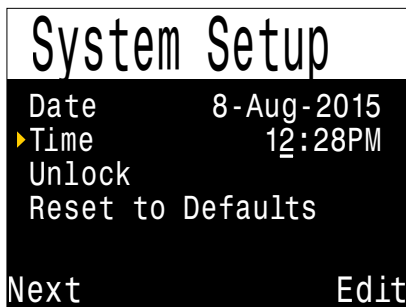

Time

The next 'System Setup' changeable option is 'Time', which allows the user to set the current time. The format can be set to AM, PM or 24 hour time



Unlock Code

The next 'System Setup' changeable option is 'Unlock' which allows the user the VPM-B Unlock in a code in order to add a 2nd decompression algorithm



Reset to Defaults

The final 'System Setup' option is 'Reset to Defaults'. This will reset all user changed options to factory settings and clear the tissues on the Perdix. 'Reset to Defaults' cannot be reversed.

Note: This will not delete dive logs, or reset dive log numbers.

Advanced Configuration 1

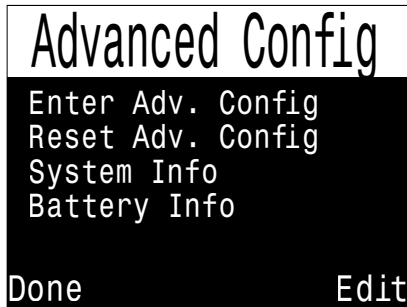

Advanced configuration contains items that will be used infrequently and can be ignored by most users. They provide more detailed configurations.

The first screen allows you to enter the advanced configuration area, or to set the advanced configurations settings to their default.

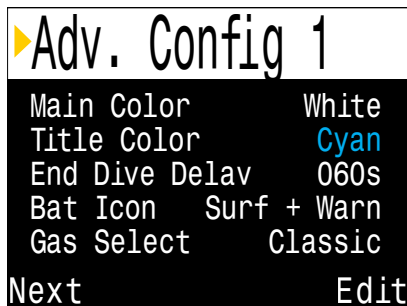

Title Colour

The title colors can be changed for added contrast or visual appeal. Default is Cyan, with gray, white and blue also available.

Main Colour

Main colours can also be changed for added contrast. Default is white but can be changed to green.

End Dive Delay

Sets the time in seconds to wait after surfacing before ending the current dive.

This value can be set from 20 seconds to 600 seconds (10 minutes). Default is 60s.

This value can be set to a longer time if you want brief surface intervals connected together into one dive. Some instructors use a longer end dive delay when teaching courses. Alternatively, a shorter time can be used to exit dive mode more quickly upon surfacing.

Battery Icon

The behavior of the battery icon can be changed here. Options are:

Surf+Warn: The battery icon always displays when on the surface. During dive it displays only if there is a low battery warning.

Always: The battery icon always displays.

Warn Only: The battery icon only appears when there is a low battery warning (this is how the Predator operates).

Gas Select

The style of Select Gas menu. Either Classic or New. Classic style shows one gas at a time in the large font. New style shows all gases at once, but in the small font.

Advanced Configuration 2

This section allows changing of PPO2 limits.



WARNING

Do not change these values unless you understand the effect.

All values are in absolute atmospheres [ata] of pressure (1 ata = 1.013 Bar)

▶ Adv. Config 2		
OC Min.	PP02	0.19
OC Max.	PP02	1.65
OC Deco	PP02	1.61
CC Min.	PP02	0.40
CC Max.	PP02	1.60
Done	Edit	

OC Min. PPO2

PPO2 displays in flashing red when less than this value. (Default 0.19)

OC Max. PPO2

PPO2 displays in flashing red when greater than this value. (Default 1.65)

OC Deco. PPO2

The decompression predictions (TTS and NDL) will assume that the gas in use at a given depth is the gas with the highest PPO2 that is less than or equal to this value. Also, the suggested gas switches (when the current gas is displayed in yellow) are determined by this value. If you change this value, please understand its effect. For example, if lowered to 1.50, then oxygen (99/00) will not be assumed at 20ft/6m. (Default 1.61)

CC Min. PPO2

PPO2 displays in flashing red when less than this value. (Default 0.40)

CC Max. PPO2

PPO2 displays in flashing red when greater than this value. (Default 1.60)

Note: In both OC and CC mode, a “Low PPO2” or “High PPO2” alert is displayed when the limits are violated for more than 30 seconds.



There is no bottom gas setting! Do not set OC Max less than OC Deco. OC Max applies for the entire dive and is only used to alert high PPO2 warnings.

Advanced Configuration 3

▶ Adv. Config 3	
Stack Timer	On
Total Time	1.65
Count When	Diving
Warn at	1:00
Alarm at	0:30
Done	Edit

DEPTH	TIME	STOP TIME
48.4	3	
1.30	1.30	1.29
STACK USED	REMAINING	
1:23	1:37	

Stack Timer

A stack timer is available for tracking the amount of time spent diving with a CO2 absorbent canister.

It can be toggled on and off in the Advanced Config. 3 menu. The total time can be set anywhere between and 1h and 9h 59m. The stack timer can be set to count down either when diving, or when the computer is ON. A warning will alert the diver when the stack timer has 1h remaining and an alarm will be displayed when the stack timer has 30 minutes remaining.

The current stack timer count used and remaining will be available as an info screen when the stack timer is enabled. The stack timer can also be reset from the main level menu. The stack timer cannot be reset during a dive.

STARTING BLUETOOTH

Bluetooth communications are used for both Firmware Uploading and Dive Log Downloading.

To start Bluetooth on your dive computer, simply press the left button 4 times, followed by the right button once.



FIRMWARE UPDATE

It is important to keep the firmware on your dive computer up to date. In addition to new features and improvements, firmware updates address important bug fixes.

There are two ways to update the firmware on your Perdix:

- 1) With Shearwater Desktop
- 2) With Shearwater Cloud Mobile



Upgrading the firmware resets decompression tissue loading. Plan repetitive dives accordingly.



During the update process, the screen may flicker or go blank for a few seconds.

FIRMWARE UPDATE USING SHEARWATER DESKTOP

Ensure that you have the latest version of Shearwater Desktop. You can get it by [clicking here](#)

In Shearwater Desktop, go to **Dive Computer** ➔ **Update Firmware**

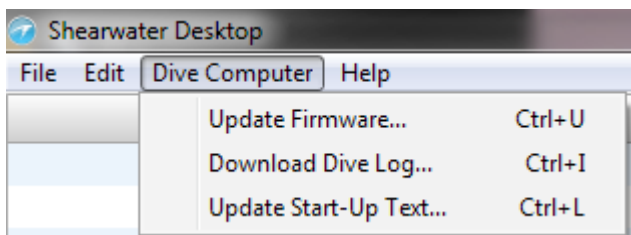

Shearwater Desktop will detect your dive computer once you start Bluetooth and will automatically select the latest available firmware.

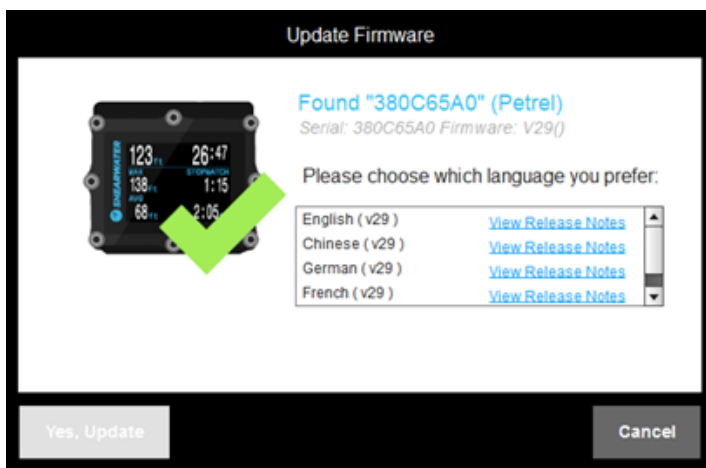

Select your language, confirm the update and Shearwater Desktop will send the firmware update to your Perdix.

The Perdix screen will give percentile updates of receiving the firmware, and then the Personal Computer will read "Firmware successfully sent to the computer" on completion.

After receiving the new firmware, the Perdix will reset and display a message stating either firmware update success or failure.

Changing Languages

If you have chosen a language other than English, you will be asked to select the language you want to use when you start your Perdix the first time.

If you want to change the language, take out the battery briefly, and the next time you start your Perdix, you will be asked to select the language.

FIRMWARE UPDATE USING SHEARWATER CLOUD MOBILE

Ensure that you have the latest version of Shearwater Cloud Mobile. Download it from [Google Play](#) or the [Apple App Store](#).

- 1) Start Bluetooth on your dive computer
- 2) Go to the connect tab on the Shearwater Mobile App
- 3) Connect your dive computer
- 4) Press the UPDATE FIRMWARE button
- 5) Select your language
- 6) Shearwater cloud mobile will send the new firmware version

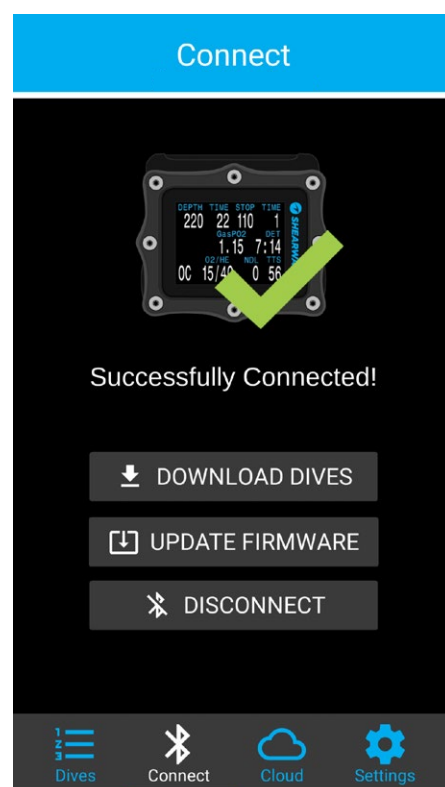
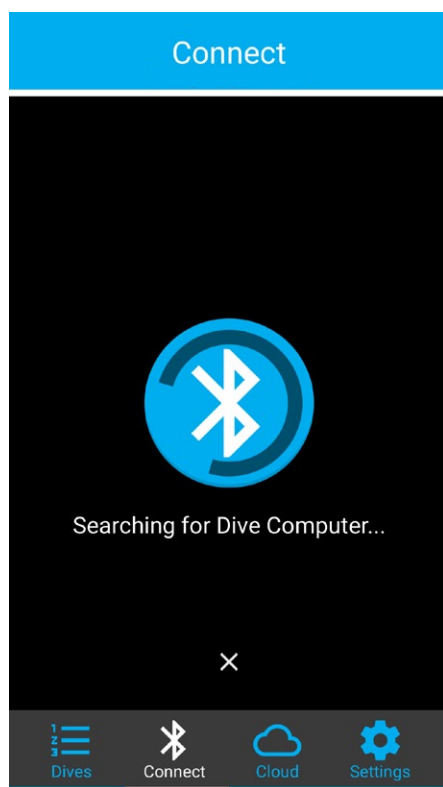
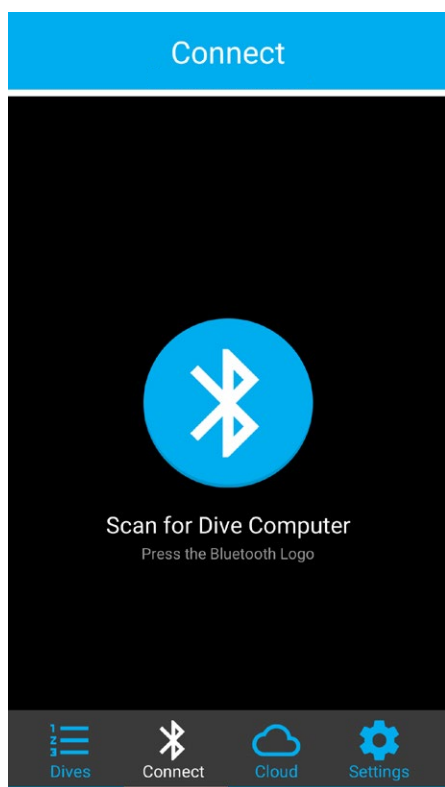

The Perdix screen will give percentile updates while receiving the firmware, and the phone will read “Firmware successfully sent to the computer” upon completion.

After receiving the new firmware, the Perdix will reset and display a message stating either firmware update success or failure.

DIVE LOG DOWNLOAD

DIVE LOG DOWNLOAD WITH SHEARWATER DESKTOP

In Shearwater Desktop, go to Dive Computer → Download Dive Log

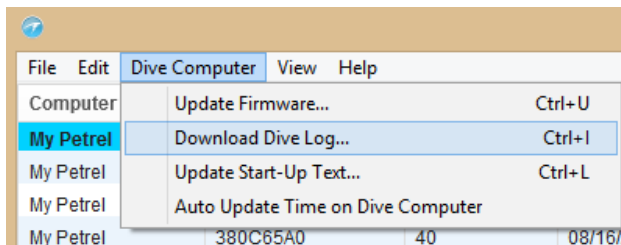

The Download Dive Log window should pop up.

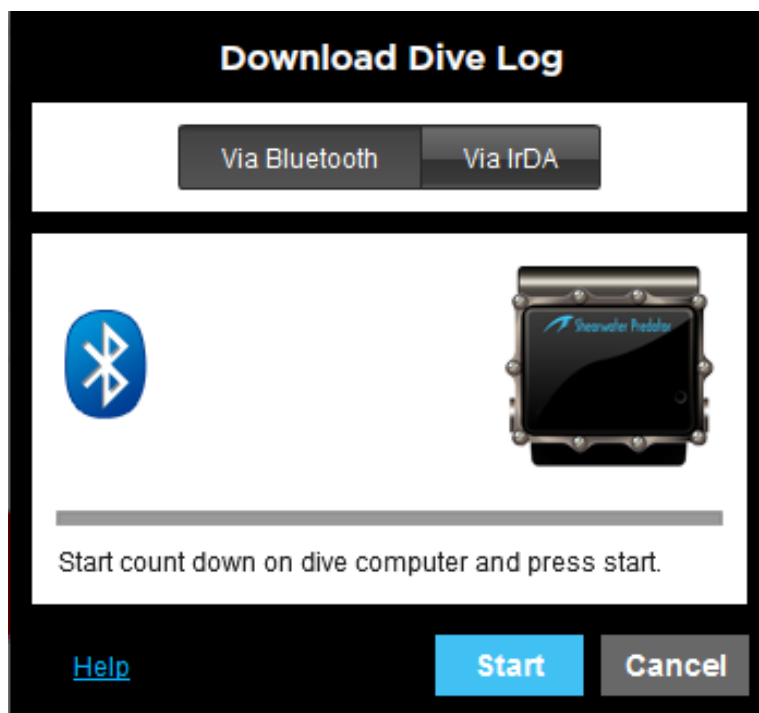

Start Bluetooth on your Perdix

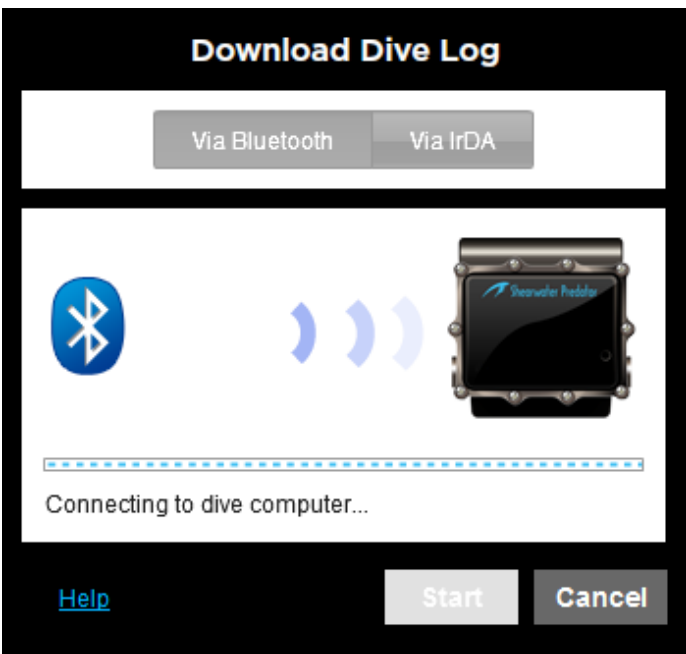

Now go back to Shearwater Desktop. Click start from the open “Download Dive Log” box. The PC will then connect to the Perdix.

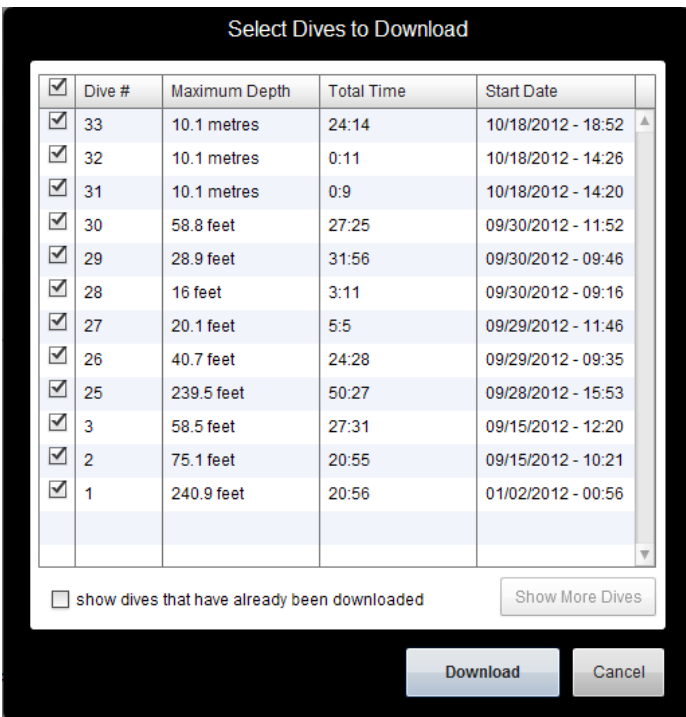

Once connected it will download a list of available dive logs and you will see a screen like this.

You can unselect any dive logs you don't want to download, or you can press “Download” to download all the dives on your Perdix. After that, Shearwater Desktop will transfer the dives to your computer.

The first time you download dives from your Perdix, you will be asked to give the Perdix a name. If you have multiple Shearwater dive computers, you will be able to easily tell which dive was downloaded from which dive computer.

DIVE LOG DOWNLOAD WITH SHEARWATER CLOUD MOBILE

In Shearwater Cloud Mobile, connect to the dive computer, and select download dives.

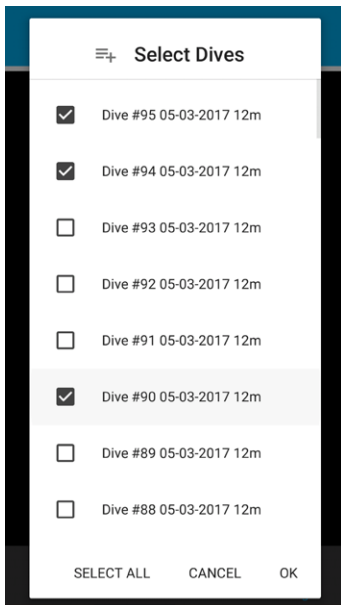
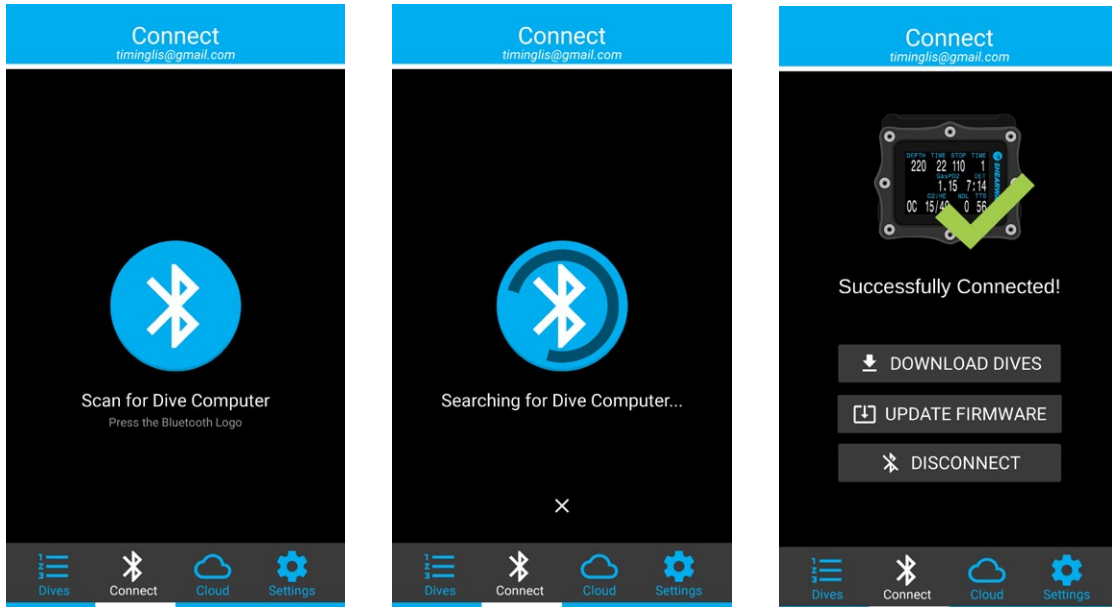

Once connected it will download a list of available dive logs and you will see a screen like this.

Select any dive logs you want to download. After that, Shearwater Cloud Mobile will transfer the dives to your Phone.

CHANGING THE BATTERY

NOTE: A large coin or washer is required for this section.

Remove the battery cap

Insert the coin or washer into the battery cap slot. Unscrew by turning counter clockwise until the battery cap is free. Be sure to store the battery cap in a clean dry space.

Exchange the battery

Remove the existing battery by tilting the Perdix computer. Insert the new battery positive contact first. A small diagram on the bottom of the Perdix shows the proper orientation.

Accepted battery types

The Shearwater Perdix can accept a wide variety of AA sized batteries. The Perdix can accept any AA sized (or 14500 size) battery that outputs a voltage between 0.9V and 4.3V.

Reinstalling the battery cap

It is very important that the battery cap O-rings are clear of dust or debris. Carefully inspect your O-ring for any debris or damage and gently clean. It is recommended that you lubricate your battery cap's O-ring on a regular basis with an O-ring lubricant compatible with Buna-N (Nitrile) O-rings. Lubricating helps ensure that the O-ring seats properly and does not twist or bunch.

Insert the battery cap into the Perdix and compress the battery contact springs. While the springs are compressed rotate the battery cap clockwise to engage the threads. Be sure not to cross thread the battery cap's threads. Tighten the battery cap until snug and the Perdix powers on. Do not over tighten the battery cap.

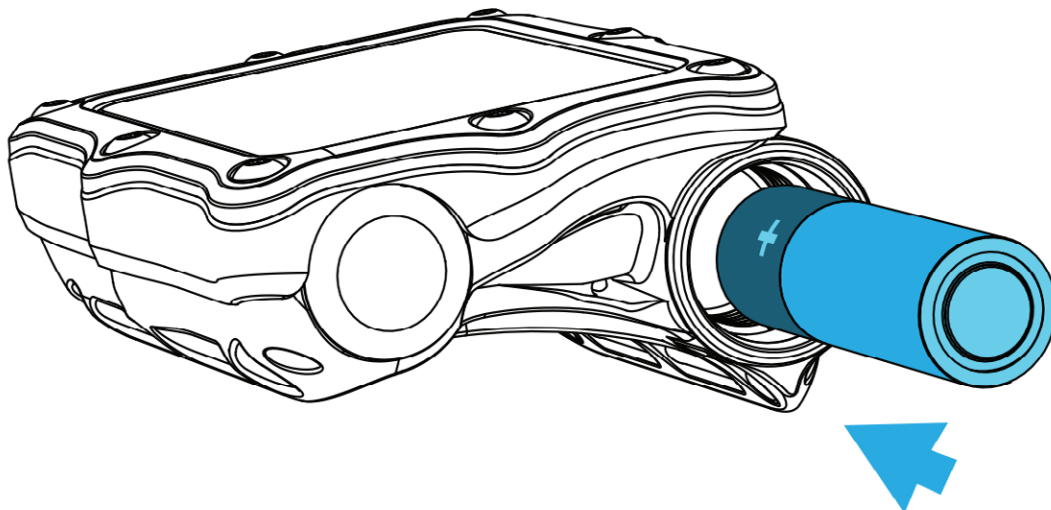

BATTERY TYPES

After changing the battery, a screen will prompt for the battery type to be entered.

The Perdix attempts to guess what type of battery is being used. If the battery type is incorrect, it should be manually edited.

Having the battery type set correctly is important so that the Perdix can give low battery warnings at the proper voltage levels.

Supported battery types are:

1.5V Alkaline: The common AA battery type that can be purchased at most supermarkets and electronics stores around the world. Not rechargeable. Inexpensive and reliable, they provide 45 hours of operation. Recommended.



ALKALINE BATTERIES CAN LEAK!

Alkaline batteries are especially prone to leaking corrosive battery acid when completely discharged. Remove discharged batteries immediately, and do not store your Perdix for more than 2 months with an alkaline battery installed.

1.5V Photo Lithium: Fairly common, but more expensive than alkalines. They provide about 60 hours of operation. Common brand is the Energizer Ultimate Lithium. Not rechargeable. Good for use in very cold water. Recommended.

1.2V NiMH: Common rechargeable batteries used in digital cameras and photo flashes. Can have high self discharge. Provide about 30 hours of operation per charge. Can die quickly, so care should be taken to ensure sufficient charge prior to diving.

3.6V Saft: The Saft LS14500 lithium batteries provide very high energy density. However, their high cost makes other battery types a better choice for most users. Provide about 130 hours of operation. Can die quickly, so care should be taken to ensure sufficient charge prior to diving.

3.7V Li-Ion: Rechargeable 14500 Li-Ion batteries provide about 35 hours of operation per charge. Can be ordered from the internet. Have more gradual voltage drop as discharged, so easier to determine remaining capacity than NiMH rechargeables. Good in cold water.

NOTE: Battery operating lifetimes are given with screen on medium brightness and at room temperature. Higher brightness and lower temperature can reduce life. Lower brightness can increase life.

BEHAVIOR ON BATTERY CHANGE

Settings

All settings are retained permanently. No loss of settings occurs when changing the battery.

Clock

The clock (time and date) is saved to permanent memory every 16 seconds when the Perdix is on, and every 5 minutes when off. When the battery is removed, the clock stops running. Once the battery is replaced, the clock is restored to the last saved value (so it is best to remove the battery while the Perdix is on for lowest error).

Quick battery changes will not require any adjustment, but the time should be corrected if the battery is removed for more than a few minutes.

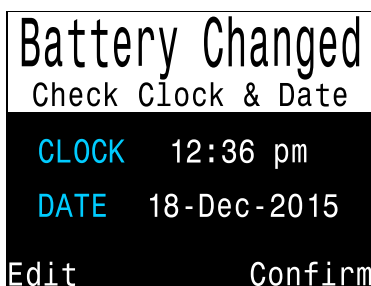

After replacing the battery a screen appears for quick adjustments to the time

The Perdix uses a highly accurate quartz crystal for time keeping. Expected drift is about 1 minute per month. If you notice higher drift, it is likely due to clock stoppage during battery changes, and is easily corrected at the time of a battery change (see image above).

Decompression tissue loading

The battery may be safely changed between repetitive dives.

Like the clock, the decompression tissue loading is saved every 16 seconds to permanent memory when on, and every 5 minutes when off.

When the battery is removed the tissues remain stored in the permanent memory and are restored once the battery is replaced, allowing for battery changes between repetitive dives. However, the Perdix does not know for how long the battery was removed, so no surface interval adjustment is applied for the time that the battery is removed.

For quick battery changes, the un-powered time interval is not significant. However, if the battery is removed shortly after a dive and then remains out for a long period, then residual tissue loading will remain when the battery is replaced. If you have not been diving for more than 4 days, it is safe to reset the tissues to their default levels (System Setup->Reset to Defaults->Tissues Only). Otherwise, just leave the tissues as is and accept the slightly higher conservatism for the next dive.

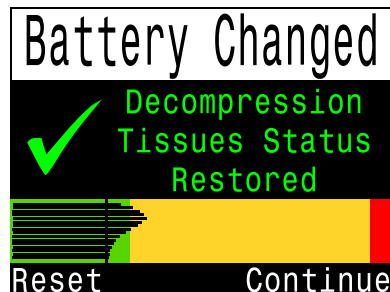

After a battery change the restored tissues are shown (with shortcut to reset)

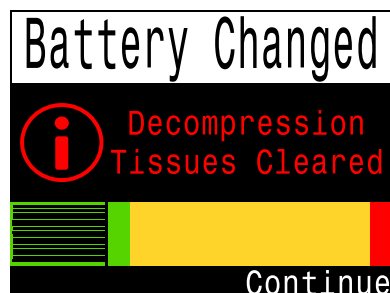

Resetting the deco tissues sets them to saturated with air at the current atmospheric pressure

If at time of battery replacement any tissue is below saturated with air at the current pressure, then that tissue is brought up to being saturated with air. This might happen after a decompression dive that used 100% O₂, where the faster tissues are often completely depleted of inert gas loading. Bringing such tissues back up to saturated with air after a battery change is the most conservative approach.

When deco tissues are reset, the following are reset:

- **Inert gas tissue loadings set to saturated with air at current atmospheric pressure**
- **CNS Oxygen Toxicity set to 0%**
- **Surface Interval time set to 0**
- **All VPM-B values set to default levels**



LIMITATIONS OF ALARMS

All alarm systems share common weaknesses.

They can alarm when no error condition exists (false positive). Or they can fail to alarm when a real error condition occurs (false negative).

So by all means respond to these alarms if you see them, but **NEVER** depend on them. Your judgement, education, and experience are your best defenses. Have a plan for failures, build experience slowly, and dive within your experience.

ALERT DISPLAYS

The system has several displays that alert to warnings, errors, and information alerts.

Each of the alerts will display the message in **yellow** until dismissed. The error is dismissed by pressing the SELECT (right) button.

The highest priority error is listed first. If multiple errors occur simultaneously, the error with the highest priority will be displayed. Clear that error by pressing the SELECT (right) button to see the next error.

Error	Description	Solution
Low PPO2	The PPO2 is below the limit set on the Adv. Config. page (default 0.19)	Change your breathing gas to one safe for the current depth.
High PPO2	The PPO2 is above the limit set on the Adv. Config. page (default 1.65)	Change your breathing gas to one safe for the current depth.
Missed Stop	A required decompression stop was violated.	Descend to deeper than the currently displayed stop depth. Monitor for symptoms of DCS. Use extra conservatism for future repetitive dives.
Fast ascent	The ascent was sustained at faster than 10m/min (33 feet/min).	Use a slow ascent rate. Monitor for symptoms of DCS. Use extra conservatism for future repetitive dives.
Tissues Cleared	The decompression tissue inert gas loading has been set to default levels.	Plan repetitive dives accordingly.
Low Battery Int.	The internal battery is low.	Replace the battery.
High CNS	Central Nervous System (CNS) toxicity clock high exceeded 90%.	Switch to a gas with a lower PPO2 or ascend shallower (decompression ceiling allowing).
Watchdog Reset	The computer has reset to recover from an unexpected software condition.	Please report to Shearwater Research Inc.

Error	Description	Solution
Reset to Defaults	Not really an error, just notification that the reset has been completed.	N/A
New Unlock	Not really an error, just notification that a new unlock has been applied.	N/A
Upgrade Failed	Firmware update failed, possibly due to a communications error or corrupted file.	Try the firmware upgrade again. Contact Shearwater if problem persists.
Various other system level errors	Other messages than those above may be shown for system level failures.	Please report to Shearwater Research Inc.

The center row also shows permanent "Low PPO2" or "High PPO2" messages when the PPO2 is not in a safe range. These message will clear automatically once a safe PPO2 is restored.



Sample Errors on Center Row



CONTACT SHEARWATER

This is not an exhaustive list. Please contact us if you experience any unexpected errors:

info@shearwater.com

ALERT DISPLAY SCREENS

These sample screens correspond to the errors listed above.

Each of the alerts will display the message until dismissed. The error is dismissed by pressing SELECT.

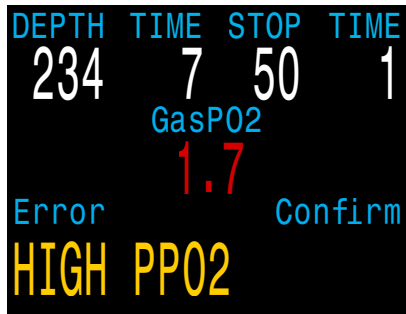

PPO2

This message will appear if the average PPO2 goes above 1.6 for more than 30 seconds.

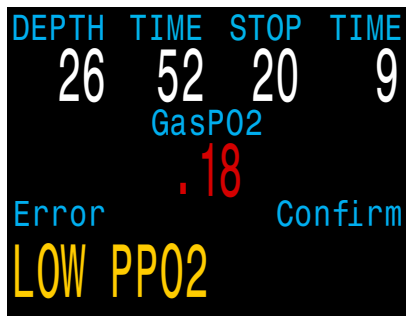

This message will appear if the average PPO2 goes below 0.4 (.19 for OC or SC) for more than 30 seconds.

It is not unusual to get this error immediately after submerging with a manual CCR and a hypoxic mix. The first breath after submerging floods the loop with low PPO2 gas. The situation is usually resolved by increasing depth such that when the error is noticed, the PPO2 is no longer low.

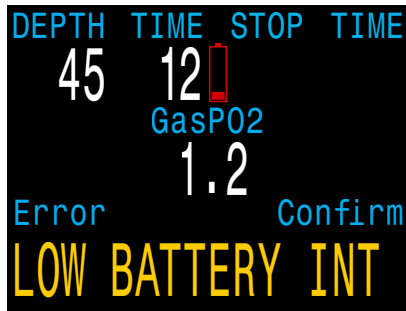

Battery

This message will appear when your internal battery is low for 30 seconds. The battery needs to be changed. The computer will also flash the battery symbol red.

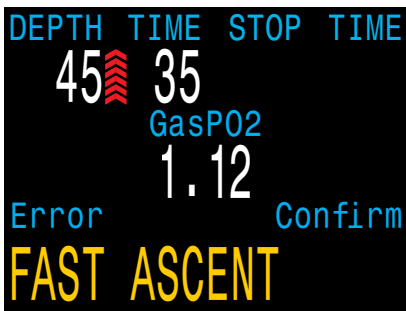

Ascent

This alarm is a notification that there has either been a very fast ascent for a short period of time, or that there has been an ascent of more than 66 fpm / 20 mpm maintained for over a minute. This alarm may return after being dismissed if the condition occurs again.

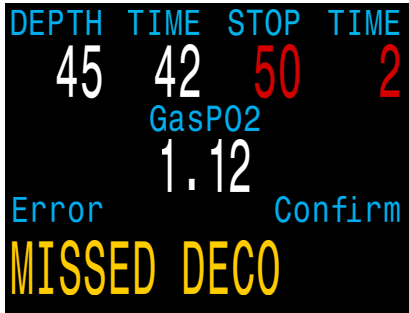

Deco

The alarm occurs when the diver has been above the minimum depth for a decompression stop for more than one minute. This alarm will only appear once during a dive, but it will also appear once on the surface after the dive.

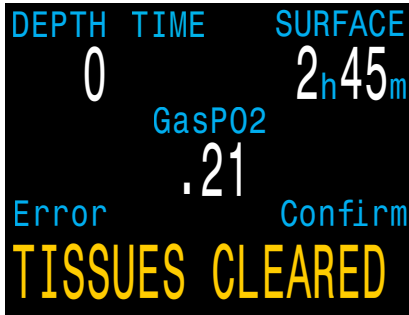

Tissues Cleared

This alarm will show when the decompression tissues are cleared. All decompression information has been lost.



Watchdog Reset

This alarm happens when the computer does not complete all of its tasks in the time allotted. It can happen occasionally from a transient problem like a battery bounce after an impact. It can also be the result of a hardware problem.

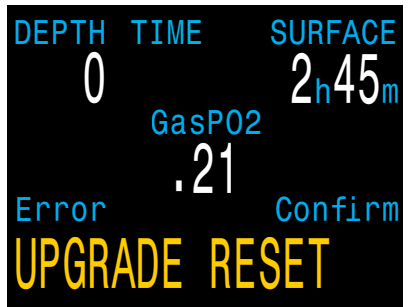

Upgrade Reset

This reset shows up after a software update. This is the normal event that shows the computer has been rebooted after the software update.

TROUBLESHOOTING

Symptom	Troubleshooting
Time of day is not accurate	The Perdix uses a highly accurate quartz crystal for time keeping. Expected drift is about 1 minute per month. If you notice higher drift, it is likely due to clock stoppage during battery changes. Adjust the time in the System menu.
Battery life is short	Ensure the battery type setting is correct. The battery gauge will not function correct if the setting does not match the actual. This can be adjusted when the battery is changed.
Battery dies without warning	Ensure the battery type setting is correct. The battery gauge will not function correct if the setting does not match the actual. This can be adjusted when the battery is changed.

STORAGE AND MAINTENANCE

The Perdix dive computer should be stored dry and clean, and without batteries installed.

Do not allow salt deposits to build up on your dive computer. Wash your computer with fresh water to remove salt and other contaminants. **Do not use detergents or other cleaning chemicals** as they may damage the Perdix dive computer. Allow to dry naturally before storing.

Do not wash under high pressure jets of water as it may cause damage to the depth sensor.

Store the Perdix dive computer **out of direct sunlight** in a cool, dry and dust free environment. Avoid continuous exposure to direct ultra-violet radiation and radiant heat.

Servicing

- ⚡ There are no user serviceable parts inside the Perdix.
- ⚡ Do not tighten or remove the faceplate screws.
- ⚡ Clean with water ONLY. Any solvents may damage the dive computer.
- ⚡ Service of the Perdix may only be done at Shearwater Research, or by any of our authorized service centers.
- ⚡ Your nearest service center can be found at www.shearwater.com/contact

Specifications

Specification	Perdix Model
Operating Modes	OC Tec OC Rec OC/CC (internal PPO2) Gauge
Decompression Model	Bühlmann ZHL-16C with GF VPM-B and VPM-B/GFS (optional)
Display	Full color 2.2" QVGA LCD with always on LED backlight
Pressure (depth) sensor	Piezo-resistive
Calibrated Range	0 Bar to 14 Bar
Accuracy	+/-20 mBar (at surface) +/-100 mBar (at 14bar)
Crush Depth Limit	27 Bar (~260msw)
Surface Pressure Range	500 mBar to 1040 mBar
Depth of dive start	1.6 m of sea water
Depth of dive end	0.9 m of sea water
Operating Temperature Range	+4°C to +32°C
Short-Term (hours) Temperature Range	-10°C to +50°C
Long-Term Storage Temperature Range	+5°C to +20°C
Battery	AA Size, 0.9V to 4.3V User replaceable
Battery Operating Life (Display Medium Brightness)	45 Hours (AA 1.5V Alkaline) 130 Hours (SAFT LS14500)
Communications	Bluetooth Smart Ready
Compass Resolution	1°
Compass Accuracy	35°
Compass Tilt Compensation	Yes, over 345° pitch and roll
Dive Log Capacity	Approximately 1000 hours
Battery cap o-ring	Dual o-rings. Size: AS568-112 Material: Nitrile Durometer: 70A
Wrist Attachment	2 x 3/4" Elastic Straps with Buckles, or 2 x Bungee Cord (3/16" diameter cord)
Weight	152 g
Size (W X L X H)	81mm X 71mm X 38mm

FCC Warning

a) USA-Federal Communications Commission (FCC)

This equipment has been tested and found to comply with the limits for a Class B digital device, pursuant to Part 15 of FCC Rules. These limits are designed to provide reasonable protection against harmful interference in a residential installation. This equipment generates, uses, and can radiate radio frequency energy. If not installed and used in accordance with the instructions, it may cause harmful interference to radio communications. However, there is no guarantee that interference will not occur in a particular installation.

If this equipment does cause harmful interference to radio or television reception, which can be determined by tuning the equipment off and on, the user is encouraged to try and correct the interference by one or more of the following measures:

- Reorient or relocate the receiving antenna
- Increase the distance between the equipment and the receiver.
- Connect the equipment to outlet on a circuit different from that to which the receiver is connected.
- Consult the dealer or an experienced radio/TV technician for help.

Any changes or modifications not expressly approved by the party responsible for compliance could void the user's authority to operate the equipment.

Caution: Exposure to Radio Frequency Radiation.

This device must not be co-located or operating in conjunction with any other antenna or transmitter. **Contains TX FCC ID: T7VEBMU**

Industry Canada Warning

b) Canada - Industry Canada (IC)

This device complies with RSS 210 of Industry Canada.

Operation is subject to the following two conditions:

- (1) this device may not cause interference, and
- (2) this device must accept any interference, including interference that may cause undesired operation of this device.

L'utilisation de ce dispositif est autorisée seulement aux conditions suivantes :

- (1) il ne doit pas produire d'interférence, et
- (2) l'utilisateur du dispositif doit être prêt à accepter toute interférence radioélectrique reçue, même si celle-ci est susceptible de compromettre le fonctionnement du dispositif.

Caution: Exposure to Radio Frequency Radiation.

The installer of this radio equipment must ensure that the antenna is located or pointed such that it does not emit RF field in excess of Health Canada limits for the general population; consult Safety Code 6, obtainable from Health Canada's [website](#).

Contains TX IC: 216QEbzzMU

CONTACT

Shearwater Research Inc.
Headquarters
13155 Delf Place, Unit 250
Richmond, BC
V6V 2A2
Tel: +1.604.669.9958
info@shearwater.com

US Service Center
DIVE-Tronix, LLC.
Snohomish, WA, USA
Tel: +1.858.775.4099
usaservice@shearwater.com

EU Service Center
Narked at 90 Ltd
15 Bentley Court,
Paterson Rd,
Wellingborough,
Northants, UK
NN8 4BQ
Tel: +44.1933.681255
info@narkedat90.com

Asia/Pac Service Center
Rob Edward
Wellington, NZ
Tel: +64.21.61535378
asiapacservice@shearwater.com

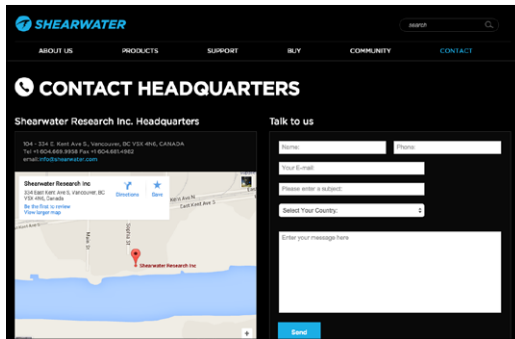

www.shearwater.com

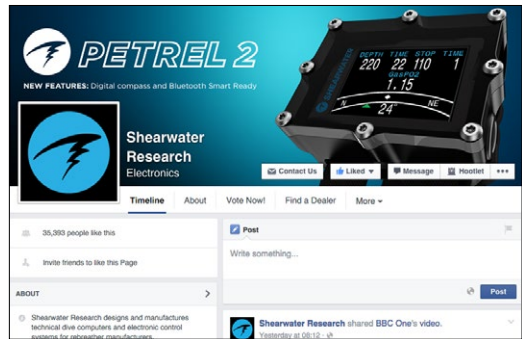

www.facebook.com/DiveShearwater



www.twitter.com/DiveShearwater

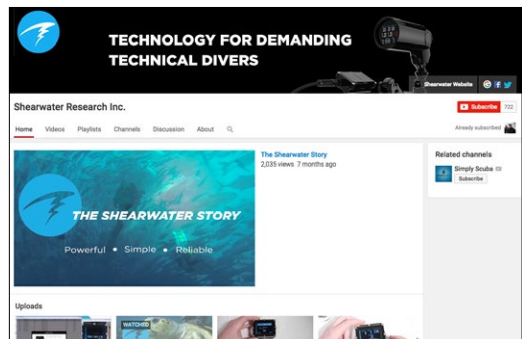

www.youtube.com/shearwaterresearch



OPERATING INSTRUCTION MANUAL

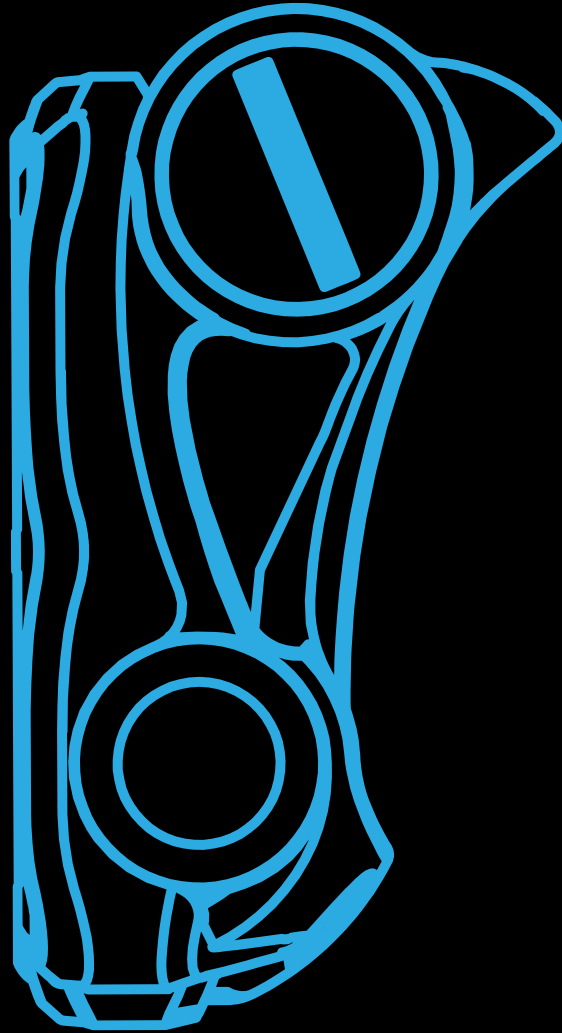

Powerful • Simple • Reliable

www.shearwater.com