

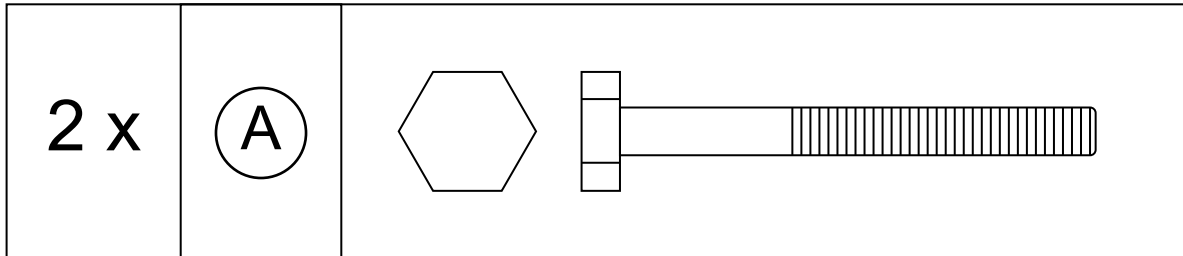

T2 PROFESSIONAL DISC GOLF TARGET
ASSEMBLY INSTRUCTIONS

Bolt



Washer

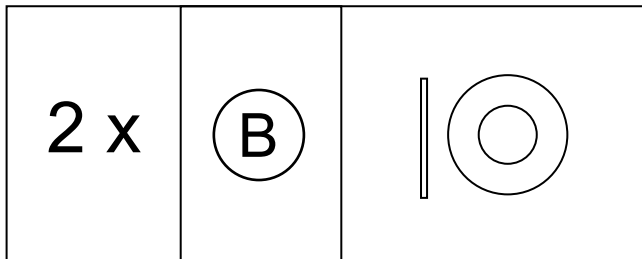

Nut

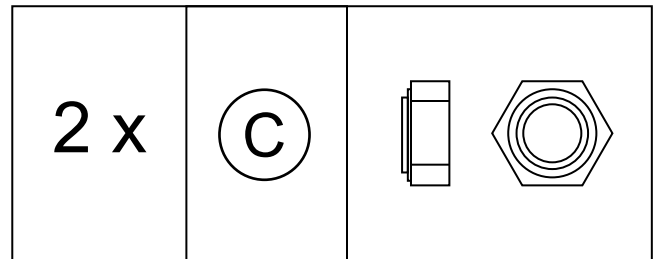

Set Screw

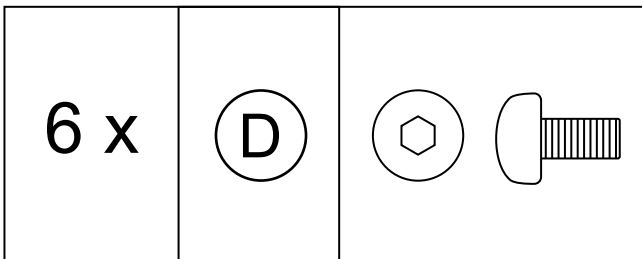

Allen Wrench

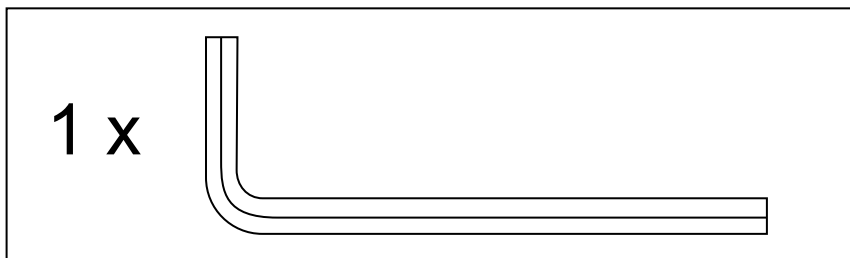



T2 PROFESSIONAL DISC GOLF TARGET ASSEMBLY INSTRUCTIONS

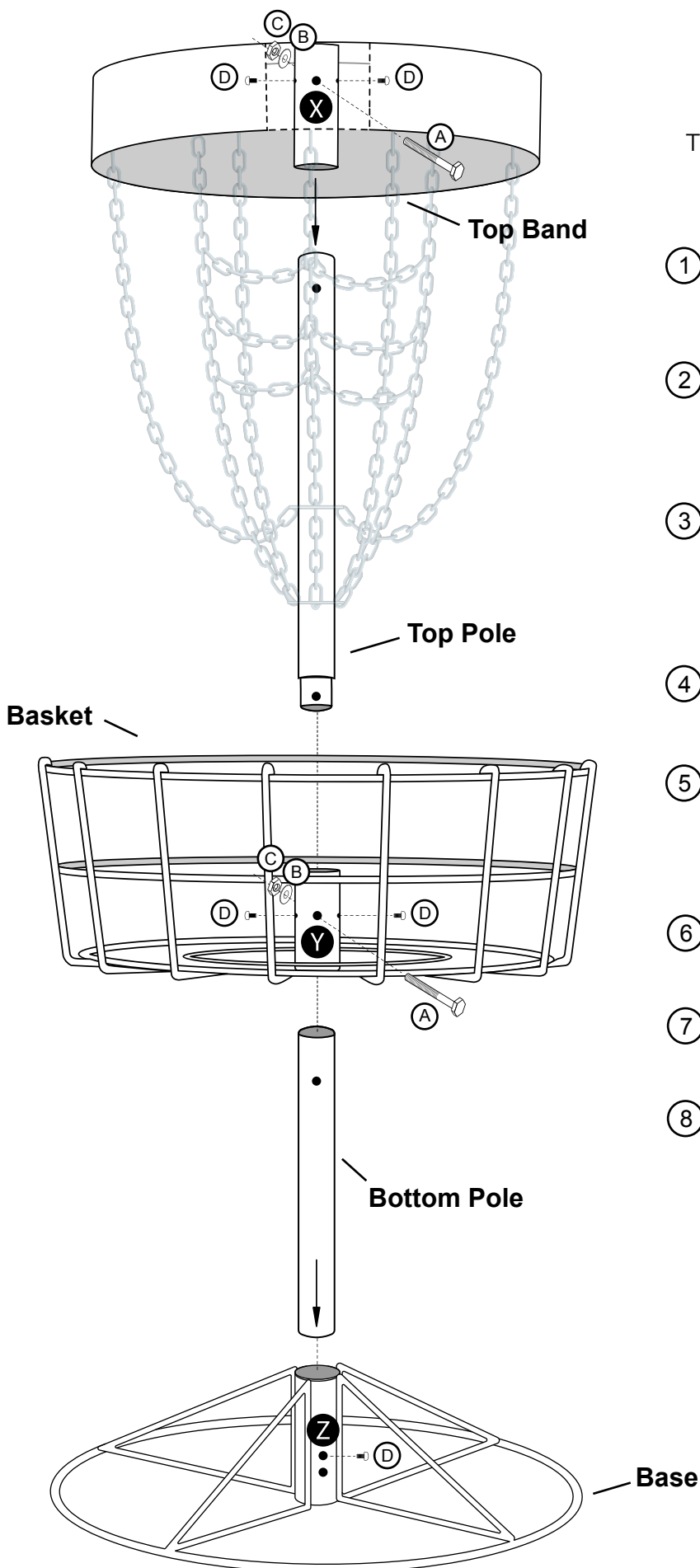

- ① Remove powder-coated set screws from holes (X), (Y) and (Z) and discard.
- ② Place base on flat ground. Insert bottom pole with no holes in the base. Insert 2 new set screws (D) and tighten.
- ③ Insert top pole into bottom pole. Line up holes on both poles. Slide basket over top pole, and down until basket and pole holes line up.
- ④ Insert bolt (A) through basket and pole holes.
- ⑤ Level the basket, then screw in two of the set screws (D) using the provided allen wrench to tighten the poles and basket into place.
- ⑥ Add washer (B) and nut (C) to bolt (A) then tighten.
- ⑦ To install top assembly, slide center ring of chains over top pole followed by top band.
- ⑧ Insert bolt (A) through the large hole on top band assembly, then screw on washer (B) and nut (C). Secure top band in place by screwing in two set screws (D).