



# *Greenline* *C, D and E*



## **Guide to installation, commissioning and maintenance**

Article nr: 290407-9

Version: 5.1



## Important information

This guide was designed to describe the operation, connection and maintenance of the heat pump as comprehensively as possible. As far as possible, the description has been written so that it can be followed step by step.

Please note that the guide consists of three separate series so it is especially ***important that the installation contractor reads the entire*** manual before commencing installation.

The guide is in two parts, one for the user and one for the installer. The table of contents sets out clearly the various sections of the manual.

**Warning!** The Rego600 control unit contains an advanced settings level which should only be accessed by the installer. The end user must never change any settings on this level, since this might have serious consequences for the operation of the heat pump.

- Before the heat pump is commissioned, the heating system and the heat transfer fluid system, as well as the heat pump itself, must have been filled and vented. The heat transfer fluid system must be filled with antifreeze (-15°C).
- Hot and cold connections might need checking after delivery.
- If the heat pump has to be carried down steps or stairs it can be leaned temporarily with the compressor downwards, but never for longer periods.
- The heat transfer fluid system must be in operation when venting the system. See chapter on refilling the heat transfer circuit.
- The control unit measures the phase sequence and alarms if the power is connected wrongly (only 3-phase units).

IVT Industrier AB

June 2003

# Table of Contents

## **PAGES FOR THE HOUSE OWNER**

<b><i>This is how your heat pump works:</i></b> _____	<b>7</b>
Heat pump technology _____	7
<b><i>Heat pump components</i></b> _____	<b>8</b>
C series components _____	8
D and E series components _____	9
<b><i>Principle</i></b> _____	<b>10</b>
Principle of heating and hot water control _____	10
Power failures _____	10
<b><i>Three different operating modes</i></b> _____	<b>10</b>
Operating mode A (not for C, D and E series) _____	10
Operating mode B (D series only) _____	10
Operating mode C (D series only) _____	10
<b><i>Controls</i></b> _____	<b>11</b>
Curve control (operating modes A and B) _____	11
Room sensor (operating modes A and B) _____	11
Fixed temperature (operating mode C only) _____	11
<b><i>Control panel</i></b> _____	<b>12</b>
Control panel buttons and displays _____	12
How to use the control panel _____	13
Examples of scrolling information _____	13
<b><i>Basic functions at customer level 1</i></b> _____	<b>14</b>
Heating and extra hot water _____	14
Temperatures _____	14
<b><i>Extra functions</i></b> _____	<b>15</b>
<b>Line 1</b>	
Room sensor affect _____	15
Holiday function _____	15
Remote control _____	15
Summer mode _____	15
<b>Line 2</b>	
Interval for hot water peak _____	15
<b>Line 4</b>	
Clock settings _____	16
<b>Line 7</b>	
Display, operating times _____	17
<b>Line 10</b>	
Setting the clock _____	17
<b>Line 11</b>	
Alarm logging of all alarms _____	17
<b>Line 12</b>	
Reset to factory settings _____	17

<b>Setting the heating</b>	<b>18</b>
How to increase or reduce the heating in your house	18
<b>Fixed temperature (D series only)</b>	<b>20</b>
Setting the heating at fixed temperature	20
<b>Simple tips for saving</b>	<b>20</b>
Utilising the heat pump in the right way	20
<b>All sensor temperatures</b>	<b>21</b>
Description of all temperatures	21
<b>If something is wrong</b>	<b>22</b>
Alarm examples and what to do	22
If the control panel is dark	22
All alarms	23
<b>Maintaining your heat pump</b>	<b>27</b>
Working on the heat pump	27
Normal maintenance	27
Control safety anode	28
<b>Where the various parts are located</b>	<b>28</b>
The various parts in the C series	28
The various parts in the D and E series	29
<b>Notes</b>	<b>64</b>

## PAGES FOR THE INSTALLER

<b>What the shipment includes</b>	<b>30</b>
Standard components	30
Accessories	30
<b>General</b>	<b>30</b>
Temperatures	30
Particle filter	30
Transportation	30
Positioning the heat pump	30
<b>Dimensions and connections</b>	<b>31</b>
Dimensions and connections, C series	31
Dimensions and connections, D and E series	32
<b>Collector</b>	<b>33</b>
Collector hose	33
Bending diameter	33
Maximal lengths	33
Connecting the collector to the heat pump	34
<b>Switching to side mounting of the fluid transfer system</b>	<b>35</b>
Ground water system	37
<b>Connecting to the heating system</b>	<b>37</b>
General	37
Connecting the C series to the heating system and operating mode A	38
Connecting the D series to the heating system and operating mode A	39
Connecting the E series to the heating system and operating mode A	40
Connecting the D series to the heating system and operating mode B	41
Connecting the D series to the heating system and operating mode C	42
Connecting the 3-way valve	43

<b>Filling</b>	<b>43</b>
Filling the radiator system	43
Filling of heat transfer fluid	43
<b>Electrical connections</b>	<b>45</b>
Circuit diagram Greenline C series. Factory connections	45
Circuit diagram Greenline D series. Factory connections	46
Circuit diagram Greenline E series. Factory connections	47
Working switch	48
Earth fault breaker	48
External connections in the C and E series.	48
External connections in the D series	49
Connecting the general alarm	50
Connecting the external input	50
Connecting the load guard	50
<b>Control unit Rego600</b>	<b>51</b>
Installer/service settings	51
<b>Installer/service menu</b>	<b>51</b>
Joint displays for operating modes A, B and C	51
Adapting the heat curve	51
Clock setting of additional heat	51
Manual control	51
Quick restart of heat pump	52
Selecting external controls	52
Choice of language	52
Selecting operating modes for heat carrier pump, P2	52
Selecting operating modes for heat transfer pump, P3 (natural cooling)	52
Version number display	52
Extra sensor acknowledgement	52
Timer reading	53
Status of the timers when checking the plant	53
Setting additional timers	53
Reset to factory settings	53
<b>Commissioning the heat pump</b>	<b>54</b>
Navigating the menu list	54
General	55
Manual testing	55
Operation with additional heat only	55
Putting into operation, operating mode A (C, D and E series)	55
Putting into operation, operating mode B (D series only)	57
Putting into operation, operating mode C (D series only)	59
Important points to check	60
Table of factory settings	60
<b>Technical information</b>	<b>60</b>
Table of selected output in display 5.2	60
Technical specifications	61
Sensor table	61
<b>Service journal</b>	<b>62</b>

# This is how your heat pump works:

## Heat pump technology

The compressor, which is driven by an electric motor, forces the refrigerant into the heat pump condenser as a gas at about 100°C. The gas and the water from the radiator system pass through the condenser, which is a fully-welded stainless steel heat exchanger. When the hot gas is cooled by the circulating water, it condenses (changes to liquid). As it does so, it provides energy for the heating system or the hot water. After the condenser, the refrigerant, which is now in liquid form, continues through a drying filter and a tank. The filter collects any moisture in the system and the tank is used as an expansion vessel for the refrigerant to ensure there is always the correct amount in the condenser.

After the filter, the refrigerant passes through a sight glass. The sight glass is used to check the amount of refrigerant in the system. In normal operation there should be no bubbles in the sight glass. However, bubbles may appear for short periods, mainly on rapid changes between hot water and radiator operation and when the heat pump starts or stops.

After the sight glass the refrigerant goes to an expansion valve. The valve acts as a flow restrictor between the high and low pressure sides of the system. The valve, which has a sensor (bulb) just before the compressor, releases the right amount of liquid into the next heat exchanger, the evaporator. In the evaporator, the liquid meets the circulating heat transfer fluid coming from the energy source in the ground or bore hole. In this process, the liquid turns to gas (evaporates) under low pressure, which uses heat. The heat is extracted from the the ground or bore hole free of charge.

After passing through the evaporator, the refrigerant is once more in the form of a gas (vapour). The expansion valve sensor constantly checks that the evaporator is performing optimally, in order to use as much free energy as possible. The gaseous refrigerant then goes to the suction side of the compressor, where it is compressed again. This completes the refrigerant circuit.

To protect the heat pump, pressure switches are fitted on the high and low-pressure sides of the system. These shut down the heat pump if the pressure in the system reaches an abnormal value. This is dealt with in more detail in the section on troubleshooting.

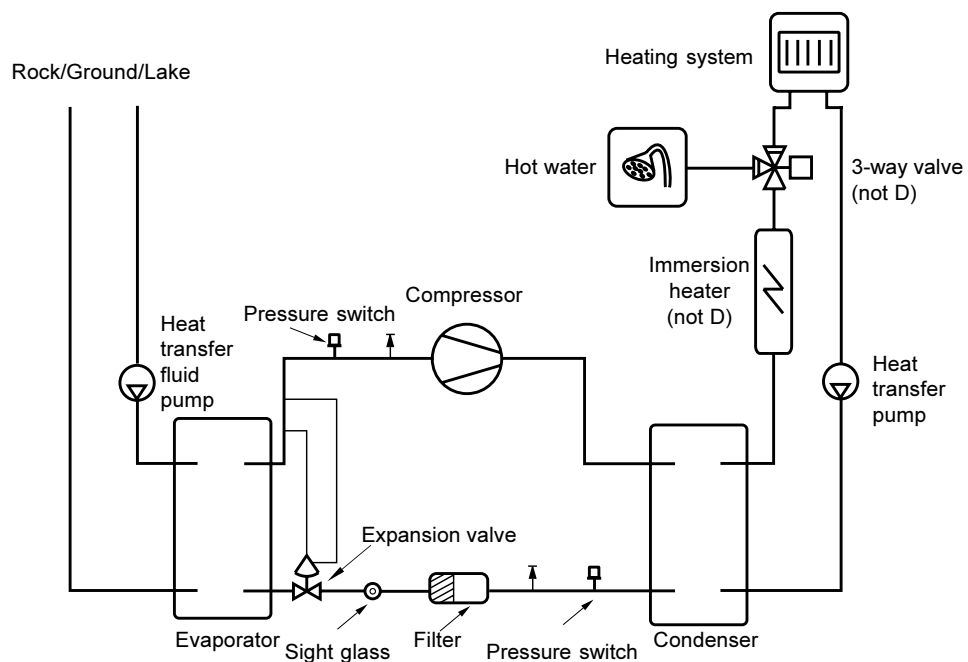

# C series components

**Please note: The picture shows a 1-phase unit.**

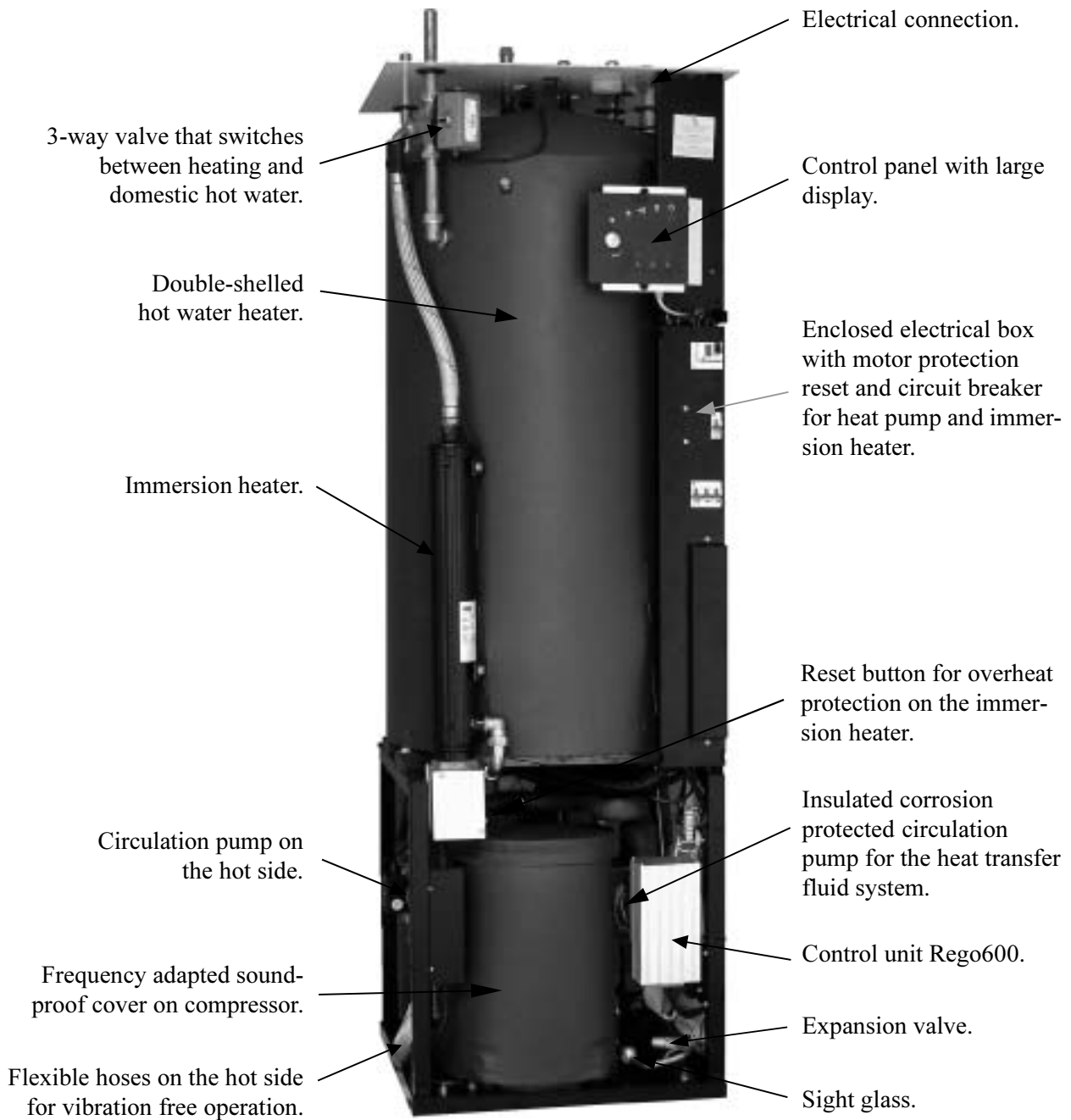

# D and E series components

**Please note: The picture is of the E series, 1-phase.**

The D series has two connections on the hot side and does not include a 3-way valve and immersion heater. The particle filter is supplied separately and is mounted outside the heat pump.

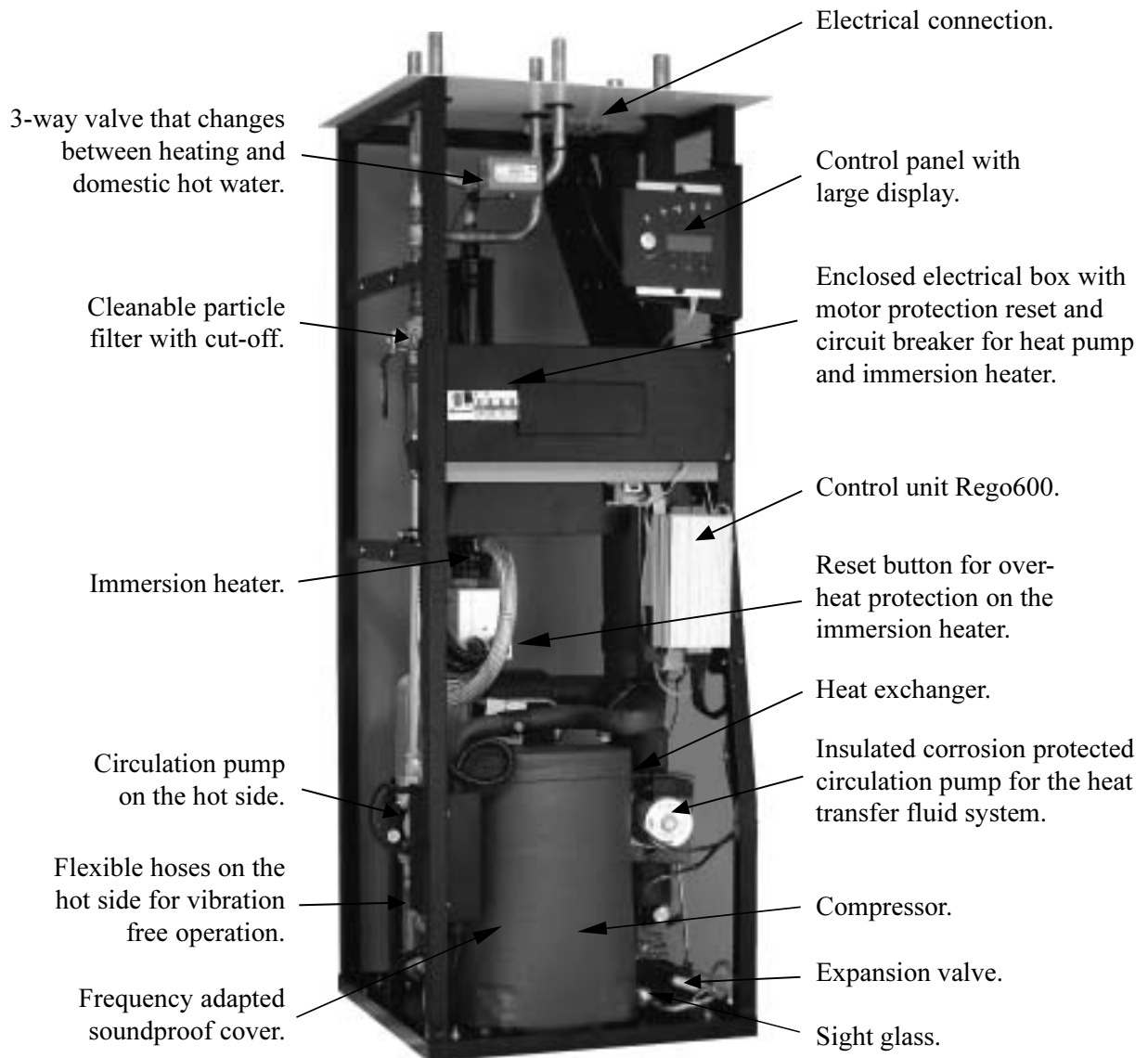



# Principle

## **Principle of heating and hot water control**

Your heat pump is fitted with a Rego600 control unit to guarantee you maximum savings and many years of service. The unit, which has advanced monitoring functions, controls the heating and hot water in your home. This ensures that all vital functions are monitored and that, if problems arise, the heat pump is shut down before it is damaged.

When the heat pump is not able to meet the heating requirements, additional heat is connected that together with the heat pump provides the required temperature. The Greenline C and E series has a built-in immersion heater that can be connected in three steps. Factory setting is 2/3 electrical output. The additional heat only provides the output that the heat pump cannot generate and in this way can never take over heating the house completely. When the heat pump is once more able to meet the heating demand, the additional heat is automatically switched off. An oil-fired boiler is normally used to provide additional heat for the Greenline D series. In which case Rego600 controls the oil-fired boiler and the existing mixing valve.

The heat pump is connected to the heating system's return flow. The water is heated in the heat pump and is then fed back to the heating system. While the heat pump is heating the water in the immersion heater, the heating system is disconnected temporarily through the 3-way valve. A sensor in the hot water cylinder makes sure that priority is always given to heating the hot water. When the water in the cylinder reaches the required temperature, heat is once more supplied to the heating system.

## **Power failure**

If the power supply fails, the control unit remembers all its settings and re-starts the heat pump when the power returns.

## Three different operating modes

The control unit can be used for three different operating modes: A, B and C. Please note that the C series *can* only utilise operating mode A. The three operating modes are also outlined under Installer.

### **Operating mode A (C, D and E series)**

This is the factory set operating mode based on an outdoor sensor that sends signals to the heat pump control unit and controls it through an adjustable control curve. Water heating takes priority over space heating. As well as operating the heat pump, Rego600 can also regulate other heat curves with a mixing valve, e.g. through a combination of radiator and floor heating systems. An immersion heater is used for additional heat.

### **Operating mode B (D series only)**

Used when additional heat is from an oil-fired boiler. Operation is the same as for operating mode A. Rego600 cannot control other heat curves in this operating mode.

### **Operating mode C (D series only)**

Used in exceptional cases, it does not provide optimal operation for the heat pump because it always works with a high temperature, or Fixed Temperature. This is most commonly used together with existing electric boilers. This mode of operation is based on the existing electric boiler's heater being kept warm by the heat pump and by utilising the existing immersion heater in the boiler.

# Controls

The control unit operates the heat pump in three ways. We call them Curve Control, Room Sensor and Fixed Temperature. Below follows a brief description.

## **Curve control (operating modes A and B)**

This is the most common mode and is also the factory setting. This means that the heat pump adjusts the heat in the house based on the outdoor temperature so that the radiator temperature increases as the outdoor temperature reduces. An outside sensor sends signals to the control unit, which automatically adjusts the supply of heat to the radiators. To set the temperature of a radiator for a certain outdoor temperature, you can choose between a number of different curves on the control unit. This maximises savings, since the heat pump never needs to work at a higher temperature than necessary. The heat pump only delivers the maximum temperature when heating the hot water. Normally, hot water heating accounts for 20% of the total annual requirement.

## **Room sensor (operational modes A and B)**

A room sensor can be connected to the heat pump. It sends signals to the control unit and in this way affects the curve control. The amount of affect the room sensor has on the curve control can be set on the control panel. The room sensor is normally only used in combination with an outdoor sensor; when a fan-assisted radiator is used in houses with electric radiators or a fire place, or in houses that are wind sensitive.

## **Fixed temperature (operating mode C only)**

This control technique is rarely used, and does not offer optimum savings from the heat pump. The principle is that the heat pump is switched on and off by the built-in return sensor and always works up to its maximum working temperature. The most common use for this control technique is when there is a relatively new electric boiler and the heat pump is connected to it. The heat pump heats the hot water cylinder in the boiler, and any additional heat required is provided by the boiler's immersion heater. There are unfortunately not many electric boilers on the market that are suitable for use in conjunction with a heat pump.

# Control panel

## Control panel buttons and displays

The control panel is the heart of your heat pump installation. From the control panel, instructions are sent to the Rego600 control unit, which ensures that the house is uniformly heated. All settings are carried out here and the display shows the settings that have been set.

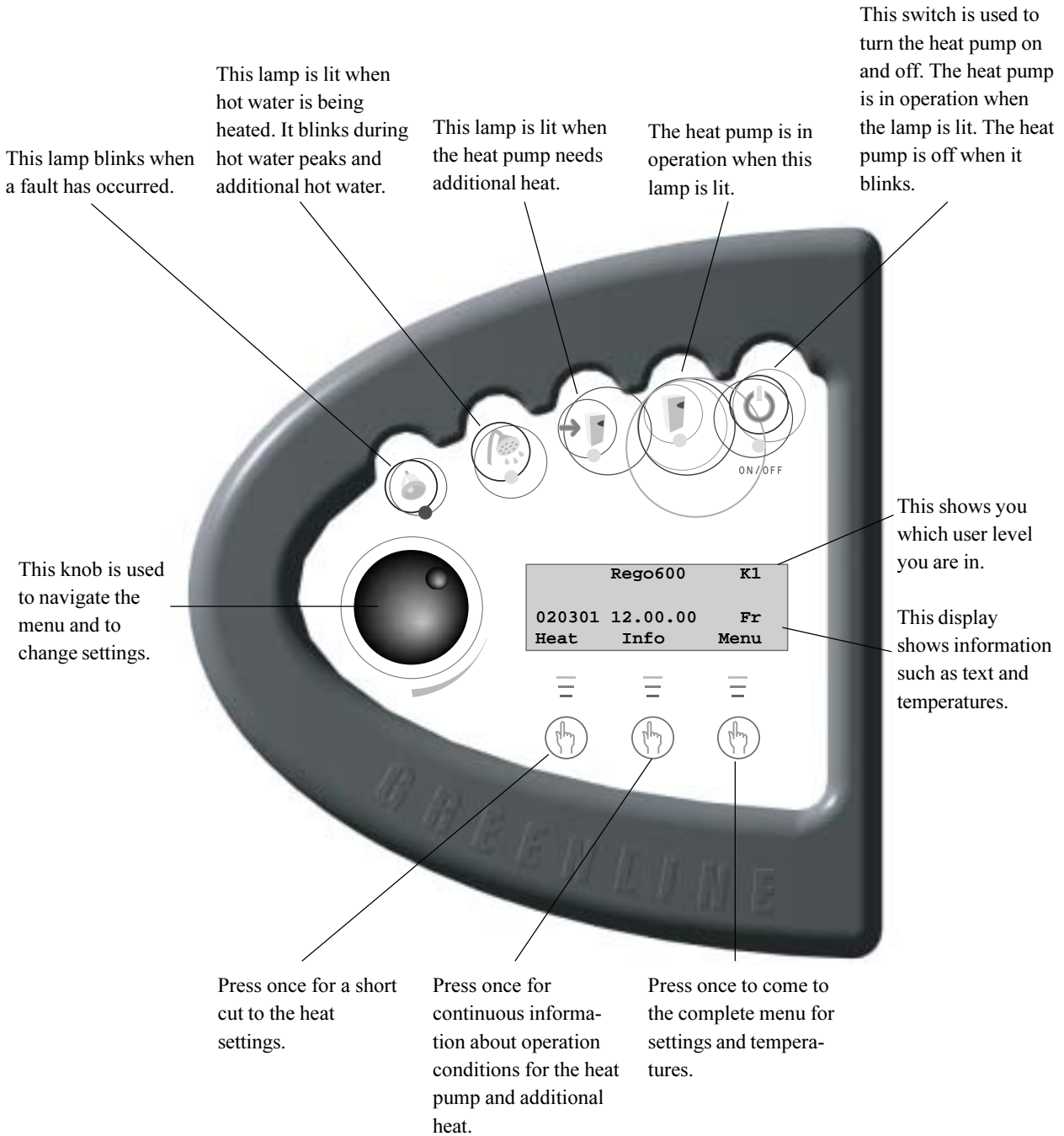

## How to use the control panel

With three buttons and a knob you can navigate to the various displays for settings and readings. The last line at the bottom of the display contains information about the functions of the buttons in the current display. If you choose Heat or Info the display you have chosen to stay in will always remain.

With the knob you navigate up and down between the displays or change the settings.

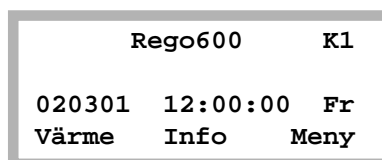
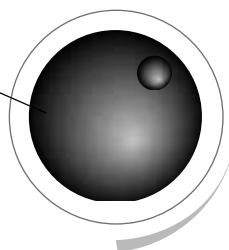

Press "Heat" once and you come to the shortcut for heat settings. You can choose to stay in which display you want.



Press "Menu" once and you come to the main menu for settings or temperature readings.

Press "Info" once and you receive continuous information about what the heat pump is doing and at which temperature it stops. You can choose to remain in this display and always receive this information. Press the middle button again to return to the first display.

## Examples of scrolling information

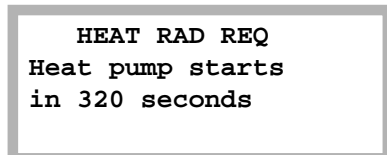
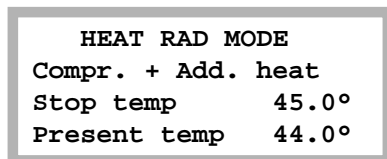
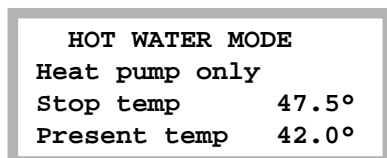
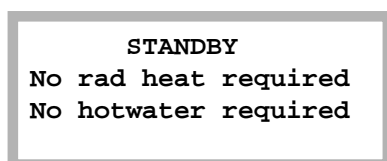

Here are some of the displays you see if you choose scrolling information with the Info button:

Heat pump is not operating.

The heat pump is producing hot water and you see the current temperature and the temperature it stops at.

The heat pump and additional heat is in operation.

A need for heat has arisen and the heat pump is waiting for the reset time to count down to zero.

# Basic functions (at customer level 1)

	Rego600	K1
020312	12.00.00	Ti
Heat	Info	Menu

## Heating and extra hot water

Press Heat to come to the short cut to the heat settings. These displays are then available.

Temp. incr. / decr.

■ ■ ■ ■ ■ ■ □ □ □ □ □ □

0                      4                      10

Return                      Adjust

Temp. fine-tune

■ ■ ■ ■ ■ ■ □ □ □ □ □ □

-10°                      0,0°                      10°

Return                      Adjust

Mix. valve incr/decr

■ ■ ■ ■ ■ □ □ □ □ □ □ □

0                      4                      10

Return                      Adjust

With extra sensor only

Mix. valve fine-tune

■ ■ ■ ■ ■ □ □ □ □ □ □ □

-10°                      0,0°                      10°

Return                      Adjust

With extra sensor only

Room temperature

■ ■ ■ ■ ■ □ □ □ □ □ □ □

10°                      20°                      30°

Return                      Adjust

With extra sensor only

Extra DHW:

□ □ □ □ □ □ □ □ □ □ □ □

1hr                      20hrs                      48hrs

Return                      Adjust

Operating mode A only

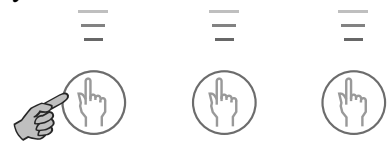

House heating settings in areas 0 to 10. See more detailed description in Heat Settings chapter.

Fine adjustment settings in areas -10 to +10. See more detailed description in Heat Settings chapter.

Here you can set the heat in areas 0 to 10 if you use an extra heat curve with a mixing valve.

Here you set the fine adjustment of the mixing valve curve in -10°C to 10°C.

If a room sensor is connected you can set the required room temperature here. At customer level 2 you can set how much you want the sensor to affect the heating system.

You can temporarily increase the hot water temperature with the electric water heater here. The heat pump first increases it to around 50° and then the electric water heater to around 65°. The electric heater starts again at 60° and increases the temperature to 65° in set time. The area is 1-48 hours and when the set time has passed, the normal operation is resumed.

## Temperatures

Press “Menu” to come to the main menu. Where you can also carry out heat settings and see the temperatures. These displays are then available.



Main menu

Indoor temperature settings                      1

Return                      Select

Main menu

Monitor all temperatures                      3

Return                      Select

The radiator temperature settings you make in the short cut to Heat you can also make in line 1 and hot water setting in line 2.

In line 3 you can see all the temperatures where sensors are connected.

# Enhanced functions

As user you have access to extra functions. Keep the Heat button pressed down for five seconds and go into Menu to gain access to these displays. You will automatically return to level 1 again after 30 seconds.

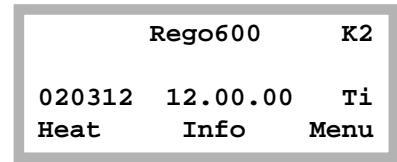

Keep the button pressed down for 5 seconds.

## Line 1

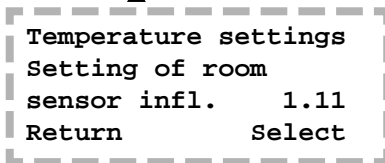
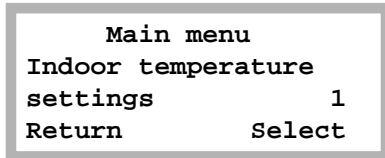

With extra sensor only

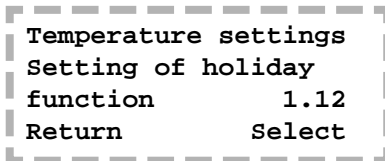

Only with extra sensor and at operating mode A only

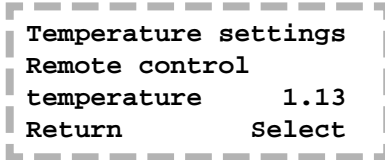

With extra sensor, remote control and at operating mode A only

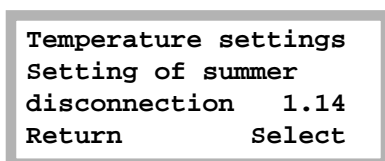

At operating modes A and B only

## Line 2

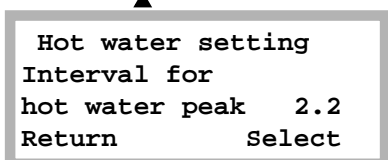
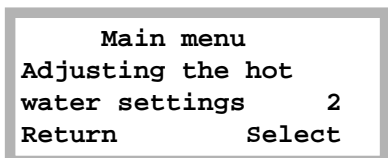

At operating mode A only

You have pressed Menu and are on row 1. Press “Select” and turn the knob and the displays scroll up. You can then choose to enter the display you require. Each display has a number.

With a room sensor installed you can set the value of how much you want it to affect the outdoor sensor. A high value gives more affect from the room sensor. *Please note the room sensor only **fine tunes** the heat curve. It is therefore important that you set the basic settings for the heat curve and fine tuning from the start.*

If a room sensor is installed you can set the number of days that the room temperature is lowered to 15°C here. The temperature is not adjustable and it does not affect the hot water. Normal operation is resumed when the period is over.

If a room sensor and remote control is installed you can set the required room temperature here. You can then use the telephone to increase the temperature to normal. This equipment is available as an accessory.

At this set temperature the heat pump only produces hot water.

Using the knob you have moved to the hot water settings in row 2.

Setting for intervals for the continual raising of the hot water temperature. If you choose for example 7 days, the temperature is raised using the electric water heater once a week to around 65°C (Operating mode A with electric water heater only).

## Line 4

```
    Main menu
Timer control
settings          4
Return          Select
```

```
    Clock setting
Clock setting HP
accord. to clock 4.1
Return          Select
```

```
    Clock setting HP 1
Mo             00:00-00:00
Return        Adjust
```

```
    Clock setting HP 1
Mo             00:00-
00:00         ^^
Cancel        ->
```

```
    Clock setting HP 1
Mo             22:00-06:00
              ^^
Cancel        <- ->
```

```
    Clock setting HP 1
Mo             22:00-06:00
Return        Adjust
```

```
    Clock setting
Setting level
heat pump +/-  4.1.1
Return        Select
```

```
    Clock setting
Clock setting DHW
accord. to clock 4.3
Return        Select
```

Not  
operating  
mode C

You have now moved to timer control settings line 4.

Here you can set the times day for day that you want to utilise the clock settings. You can set all the weekdays independent of each other. Press "Select".

The example describes how you set Monday between 22:00 and 06:00. Press "Adjust".

There is now a cursor under Monday. Turn the knob and mo becomes Mo. Monday is now activated.

Now set the clock setting for between 22:00 and 06:00 in the morning. Press the right arrow button until the cursor is under the first 00. Turn the knob until 22:00 appears. Press the button twice more (the cursor moves two steps to the right) and turn the knob until 06:00 appears. Press the right arrow button once more and the arrow is replaced by Save. Press "Save" to set the timer controls.

You can now do the same for all the other days of the week you want to timer control. Use the knob in this display to come to the other days.

In display 4.1.1 you set how much you want the temperature to be raised or lowered in the above time zone settings. If you choose for example -5°C, the heating system temperature is lowered by 5°C.

In display 4.3 you can disconnect the hot water completely during e.g. peak rate times. This is done in the same way as with the heat pump time controls.

## Line 7

```
Main menu
Op. time readings on
HP and add. heat 7
Return          Select
```



```
Op. time readings
Heat pump in operat.
number of hours? 7.1
Return          Select
```

```
Op. time readings
Distribution HP
DHW-Rad in %    7.2
Return          Select
```

Not  
operating  
mode C

```
Op. time readings
Add. heat in operat.
number of hours? 7.3
Return          Select
```

```
Op. time readings
Distribut. add. heat
DHW-Rad in %    7.4
Return          Select
```

Not  
operating  
mode C

In line 7 you can read the running times for the heat pump and additional heat. Press “Select” to enter these menus.

Here you can see how many hours the heat pump has been in operation.

This shows the distribution of the heat pump between hot water and heating in percentage.

Here you can see how many hours the additional heat has been in operation.

This shows the distribution of the additional heat between hot water and heating in percentage.

## Line 10

```
Main menu
Clock, setting
time and date 10
Return          Select
```

You can set the clock to the correct time if it is wrong.

## Line 11

```
Main menu
Alarm logging
of all alarms 11
Return          Select
```

Line 11 shows a record of the alarms that may have occurred on your heat pump. You can see the type of alarm and when it occurred. An \* in the display means the alarm is still active.

## Line 12

```
Main menu
Return to
factory settings 12
Return          Select
```

If you want to change your settings at customer levels 1 and 2 you can return to factory settings on line 12.

**Please note:** If you at the level for installer/service when you choose factory settings, **the** installer must carry out a new start-up of the plant with new settings. The installer/service level is for installer only. As end-user you must never go into this level!



# Setting the heating

In the Temperature increase/decrease display you use the knob to change the heat curve. The lines show how the return temperature varies with the outdoor temperature for different settings. The colder the weather the warmer the heating system. Curve 4 is the factory setting and in the example you can see that this gives a return temperature of around 35°C at an outdoor temperature of 0°C.

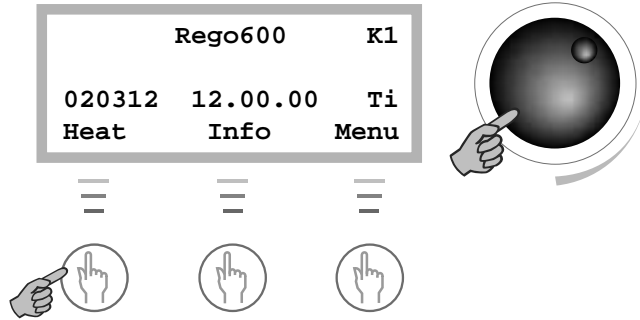

**Please note** that the flow temperature is then around 7-10°C warmer. During the first winter, the heat curve must be set up so that the temperature in the house is pleasant whatever the weather. The heat curve should preferably be adjusted at a low temperature under 3°C. You should wait two days after adjusting before carrying out any readjustments. Also note that a lower curve setting gives a lower running cost.

## The appearance of the heat curve

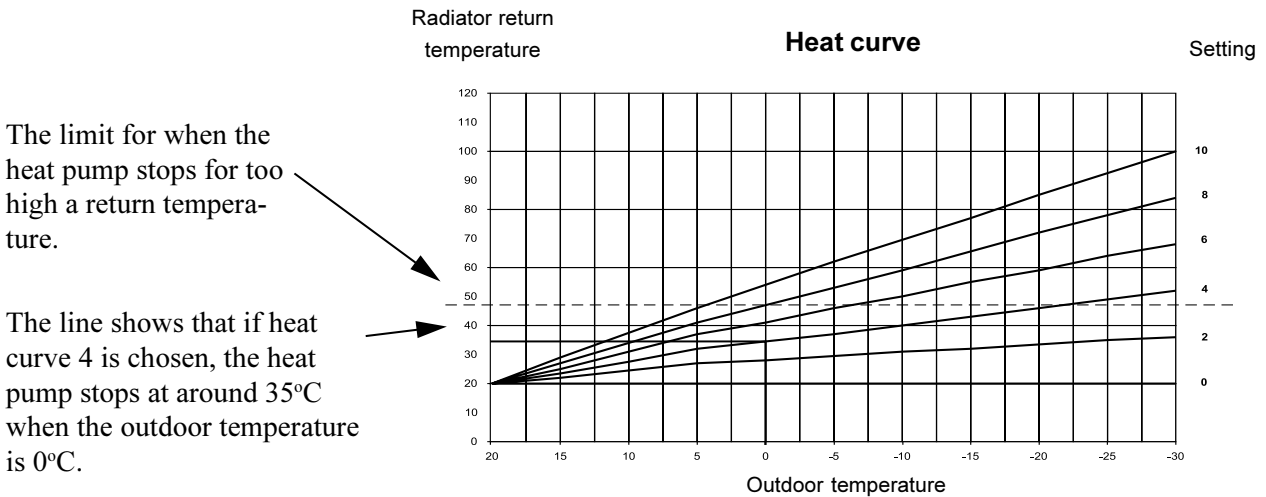

The limit for when the heat pump stops for too high a return temperature.

The line shows that if heat curve 4 is chosen, the heat pump stops at around 35°C when the outdoor temperature is 0°C.

The example describes how to change the heat curve in the Heating increase/decrease menu. **Please note** that a high value could cause the heat pump to stop if the return temperature is too high.

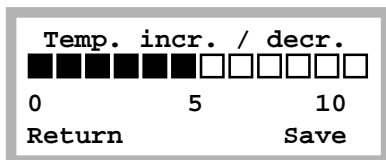
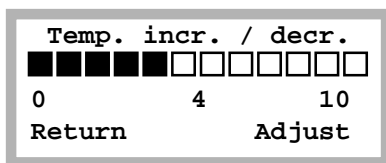
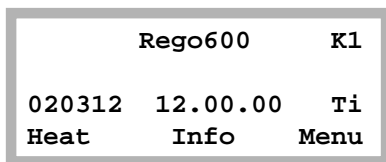

### Cold weather:

If the indoor temperature is too low or too high during cold weather, you use Temp. incr./decr. to change it. Press "Heat".

The set value is shown in the display. In the shape of a bar but also as a digit. The area is between 0 and 10. Press "Adjust".

Turn the knob to the right to increase, to the left to decrease. The example shows how you increase the value to 5. Turn the knob until 5 appears in the display. The new value now appears in the display. Press "Save" to save the new value.

The heat curve can also be fine tuned. You do this in the Temp. fine tune display. The dotted line illustrates how the parallel offset has been turned towards plus. The *entire curve* moves upwards, in contrast to increasing the slope, when only the slope changes.

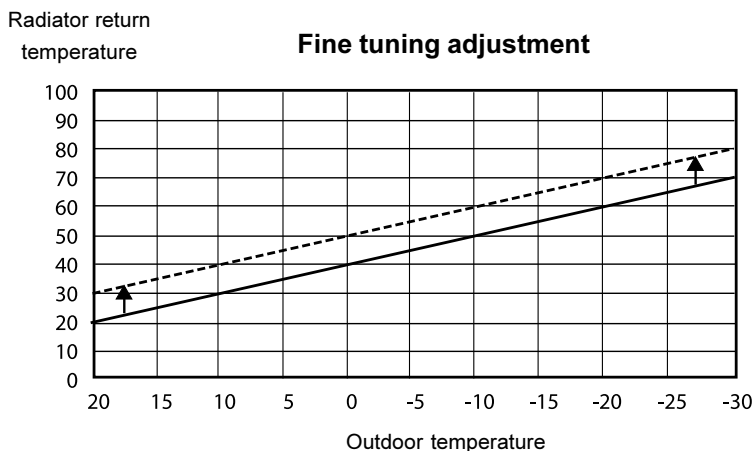

The dotted line illustrates how the fine tuning adjustment has been turned towards plus.

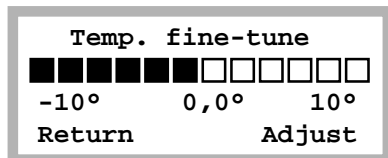
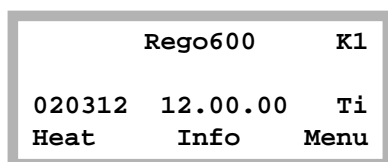

#### Warm weather:

If the indoor temperature is too low or too high during warm weather, you use fine tuning to change it. You come to “Temp. fine-tune” by pressing “Heat” and turning the knob to the right.

Fine tuning can be set in areas  $-10^{\circ}\text{C}$  to  $10^{\circ}\text{C}$ . You change the fine tuning in the same way as “Temp. increase/decrease” as described on the previous page.



# All sensor temperatures

Below are the various sensor temperatures that are visible under line 3 in the control panel. Note that not all the sensors are standard but are available as accessories for different areas of use. To get there press "Menu" in the control panel and then turn the knob to line 3. Then press "Select".

## Line 3

<p>Temperature readings Return radiator GT1 Off ##,#° Now ##,#° Return</p>	Standard	Shows the temperature of the heating system return flow. This varies depending on the outdoor temperature.
<p>Temperature readings Out GT2 ###,#° Return</p>	Standard	Shows the outdoor temperature.
<p>Temperature readings Hot water GT3 Off ##,#° Now ##,#° Return</p>	Only in C-serie	Shows the temperature in the outer container of the electric water heater's bottom part. This temperature is around 5°C lower than the temperature in the hot water tank.
<p>Temperature readings Shunt, flow GT4 Tgt ##,#° Now ##,#° Return</p>	Accessories	If an extra mixing valve is used for e.g. floor heating then the flow pipe is visible on the circuit. It varies with the outdoor temperature.
<p>Temperature readings Room GT5 Tgt ##,#° Now ##,#° Return</p>	Accessories	If a room sensor is used, you see the temperature of the room where the sensor is located.
<p>Temperature readings Compressor GT6 ###,#° Return</p>	Standard	The sensor shows the working temperature of the compressor. It varies between around 70°C and 125°C.
<p>Temperature readings Heat trfluid out GT8 ###,#° Return</p>	Standard	The sensor shows the outgoing temperature from the heat pump. It varies depending on the outdoor temperature and if the heat pump is in hot water production mode.
<p>Temperature readings Heat tr fluid in GT9 ###,#° Return</p>	Standard	The sensor shows the ingoing temperature to the heat pump. It varies as mentioned above. Please note that for safety reasons the heat pump stops when this shows a temperature of more than 48°C.
<p>Temperature reading Ht trfld(coll)inGT10 ###,#° Return</p>	Standard	The sensor shows the temperature from the bore hole or the ground. It normally varies between -5°C and 8°C throughout the year.
<p>Temperature reading Httrfld(coll)outGT11 ###,#° Return</p>	Standard	The sensor shows the temperature to the bore hole or the ground. It is normally 1.5°C till 5°C lower than heat transfer in.

# If something is wrong

The control unit provides a lot of information about faults and how to remedy them. The control unit incorporates advanced functions to monitor and protect your heat pump. This means there is no risk involved in resetting an alarm. If a fault persists, you should contact the installer.

## Alarm examples and what to do

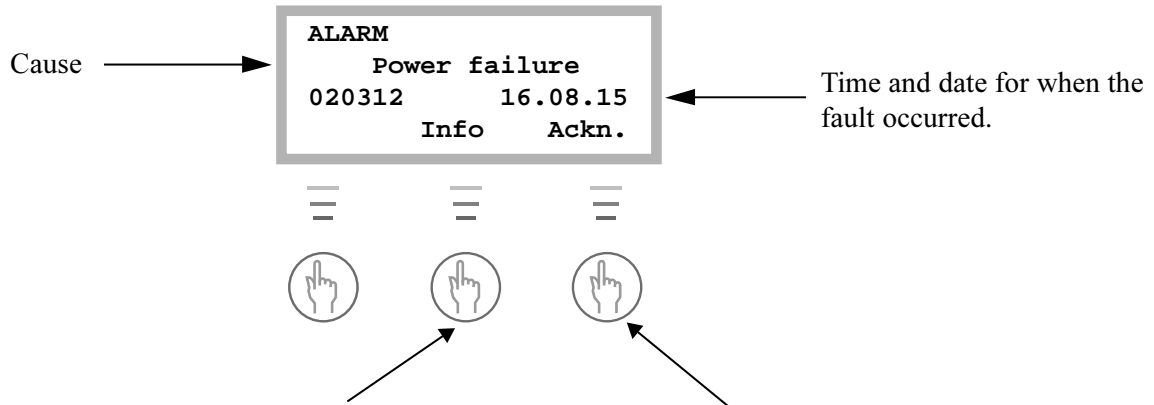

If you press "Info" and then turn the knob you will see information about the possible causes and how you can remedy the fault yourself.

Press "Ackn" and the fault is remedied, the alarm lamp goes off and the heat pump starts again within 15 minutes. If the lamp is lit with a steady glow then the alarm is remedied but the fault remains. If several alarms have triggered, use the knob to navigate to them.

---

## If the control panel is dark

### Possible faults:

- The fuses or MCBs (miniature circuit-breakers) in your fuse box.

**This is what to do:** Check the fuse (or MCB) for your heat pump. If the small plate at the bottom of the fuse has come off, the fuse has blown and must be replaced. If you have MCBs, and they have tripped, move the switch to the up position.

*Note that the heat pump cannot restart until after 15 minutes. This delay is needed for technical reasons!*

- If the heat pump MCB has tripped, this is what to do:

### The C series

Reset by pushing the toggle to the up position.

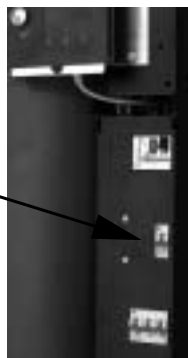

### On D and E series:

Reset by pushing the toggle to the up position.

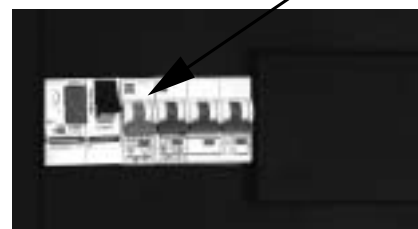

# All alarms

Below is a description of the alarms that can appear in the menu display. The description gives an idea of what the fault is and what you yourself can check and remedy. An alarm can sometimes occur temporarily so there is never any risk with resetting it. If a fault persists, you should contact the installer.

The description sometimes refers to a heat pump component. Pages 28 and 29 have details of where to find the components.

ALARM	(MB1)
Compr. circ. switch	
020312	16.08.15
Info	Ackn.

## COMPRESSOR MOTOR CUTOFF SWITCH ALARM

### To reset the alarm:

Reset the motor cutout by pressing in the black button (position 2) Then press "Ackn". *NOTE:* The lamp goes out even if the motor cutout has not been reset. (Model C4 have built-in temperature protection in the compressor that resets automatically when the temperature has reduced).

### Probable causes and actions:

- Sporadic fault or overloading of the power supply.  
**Action:** Reset the motor cutout and wait and see. (Not model C4)
- The current setting of the motor cutout is too low. The compressor's current intensity varies during summer/winter operation. (Not model C4)  
**Action:** Contact the installer.
- Contactor or cutout faulty, or loose electrical connections to the compressor.  
**Action:** Contact the installer.
- Compressor faulty.  
**Action:** Contact the installer.

ALARM	(MB2)
HTF circ-pump switch	
020312	16.08.15
Info	Ackn.

## HEAT TRANSFER FLUID CIRCULATION PUMP SWITCH ALARM

**To reset the alarm:** Press "Ackn". (11 kW-models have built-in motor cutout in the pump that resets automatically after a period of time. The MB2-alarm is not shown in other models). Note that the lamp goes out even if the motor cutout has not been reset.

### Probable causes and actions:

- The pump has stopped because of contaminants.  
**Action:** If the pump has an air vent screw it can be loosened and the pump restarted with a screwdriver.
- Fault in the pump's electric motor.  
**Action:** Contact the installer.
- Temporary fault.  
**Action:** If the fault persists, contact the installer.

ALARM	(LP)
Low pressure switch	
020312	16.08.15
Info	Ackn.

## ALARM ON PRESSURE SWITCH LOW

To reset the alarm: Press "Ackn".

### Probable causes and actions:

- Air in the heating system.  
**Action:** Check the expansion vessel and fill if required. If air is heard continuously in the system, contact the installer.
- Heat transfer pump has stopped or is set at too low a speed.  
**Action:** Check the pump has not stopped or is set at the wrong speed.
- Particle filter on the cold side has clogged.  
**Action:** Check the filter and clean if required.
- Not enough refrigerant in the circuit.  
**Action:** Check that bubbles do not appear continuously in the sight glass. Contact the installer.
- Not enough antifreeze in the heat transfer circuit creating ice in the heat exchanger.  
**Action:** Contact the installer.
- Expansion valve faulty (alarms occur at long intervals, about every three or four weeks).  
**Action:** Contact the installer.

ALARM	(HP)
High pressure switch	
020312	16.08.15
Info	Ackn.

## HIGH PRESSURE SWITCH ALARM

To reset the alarm: Press "Ackn".

### Probable causes and actions:

- Air in the heating system.  
**Action:** Check the system and vent the radiators if necessary.
- Not enough flow over the heat pump.  
**Action:** Check that the circulation pump has not stopped and that a valve in the system is not shut.
- Hot side particle filter clogged.  
**Action:** Check the filter and clean if required.
- Refrigerant circuit over-filled.  
**Action:** Contact the installer.
- Drying filter clogged.  
**Action:** Contact the installer.

```
ALARM (GT6)
Compressor superheat
020312 16.08.15
Info Ackn.
```

### ALARM ON COMPRESSOR SUPERHEAT

To reset the alarm: Press “Ackn”.

#### Probable causes and actions:

- The working temperature of the compressor is too high.  
**Action:** If the fault persists, contact the installer.
- Sporadic temperature rise due to abnormal operating conditions.  
**Action:** Wait and see.

```
ALARM
3-phase incorrect
020312 16.08.15
Info Ackn.
```

### PHASE SEQUENCE FAULT ALARM

(Only 3-phase units)

To reset the alarm: The alarm does not reset until the phase sequence has been changed. Then the heat pump starts automatically.

#### Probable causes and actions:

- Phase sequence to the heat pump is incorrect.  
**Action:** The phase sequence to the incoming supply must be changed.

```
ALARM
Power failure
020312 16.08.15
Info Ackn.
```

### POWER FAILURE ALARM

To reset the alarm: The alarm resets itself and the heat pump starts automatically when the fault has been corrected.

#### Probable causes and actions:

- One or two phases are missing to the heat pump.  
**Action:** Check the fuse (or MCB) for your heat pump. If the small plate at the bottom has come loose then the fuse is broken and must be replaced. If you have circuit breakers that have tripped, reset by pushing the switch upwards.

```
ALARM (EK)
Electrical cassette
020312 16.08.15
Info Ackn.
```

### ELECTRIC WATER HEATER ALARM

To reset the alarm: Reset water heater’s MCB (pos 4) or overheat protection (pos 5). Press “Ackn”.

#### Probable causes and actions:

- The electric water heater MCB has tripped  
**Action:** Reset the MCB by pushing the switch upwards. If the MCB trips again then the water heater is probably faulty, contact the installer.
- The electric water heater overheat protection has tripped  
**Action:** Reset by pressing the button on heater’s protective cover until it clicks. It could depend on a bad flow over the heater caused by the circulation pump standing still or clogged particle filter. Check the filter and circulation pump.



ALARM	(GT9)
High return HP	
020312	16.08.15
Info	Ackn.

### ALARM, HIGH RETURN TO THE HEAT PUMP

**To reset the alarm:** The alarm resets itself and the heat pump starts automatically when the temperature has dropped.

#### Probable causes and actions:

The heat pump has a sensor that stops the heat pump for safety reasons when the return temperature is too high, about 48°C.

- The temp. incr/decr knob is set so high that the heating system return temperature goes too high.  
**Action:** Reduce the temp. setting.
- The hot water temperature is set too high.  
**Action:** Contact the installer.
- The radiator or underfloor heating system valves are closed.  
**Action:** Open the valves.
- The flow across the heat pump is greater than the flow in the heating system.  
**Action:** Reduce the speed of the circulation pump in the heat pump or increase the speed of the mainpump in the heating system. Contact the installer.

ALARM	(GT8)
Heat tran. fluid out	
020312	16.08.15
Info	Ackn.

### HEAT TRANSFER FLUID SYSTEM OUT MAX ALARM

**To reset the alarm:** The alarm resets itself and the heat pump starts automatically when the temperature has dropped.

#### Probable causes and actions:

The heat pump has a sensor that stops the pump for safety reasons when the outgoing temperature is too high at around 75°C.

- Not enough flow over the heat pump.  
**Action:** Check that the circulation pump has not stopped and that a valve in the system is not closed.
- Hot side particle filter clogged.  
**Action:** Check the filter and clean if required.

ALARM	(GT1)
Sensor return rad.	
020312	16.08.15
Info	Ackn.

### SENSOR ALARM

**To reset the alarm:** The alarm resets itself and the heat pump starts automatically when the fault has been corrected.

#### Probable causes and actions:

Alarm if a sensor fault can be indicated for all sensors that are connected to the heat pump. The example shows the alarm for the Return radiator, GT1 sensor. The principle is the same for all sensor alarms.

- Temporary fault.  
**Action:** Wait and see.
- Short circuit or disconnected to sensor.  
**Action:** If you have an instrument that can measure resistance, you can check the resistance of the circuit and compare with the table for sensors in Technical spec. If not, contact the installer.
- Faulty sensor or faulty connection.  
**Action:** Contact the installer.

# Maintaining your heat pump

Your heat pump normally requires little maintenance, but we recommend occasional checking to ensure that your heating installation give the best possible performance. The description sometimes refers to a heat pump component. You find these on the following pages.

## Working on the heat pump

- Switch off the electrical supply before commencing work on the heat pump. Usually there is an isolating switch on the wall before the heat pump.
- Only an accredited refrigeration company is permitted to work on the refrigerant circuit. The installation contains gases that may form toxic fumes when combined with discharges and naked flames. The gas that forms may cause choking even at low concentrations. If it should leak, evacuate the room until it has been thoroughly aired.

## Normal maintenance

Points to check a few times a year:

- **Sight glass** (pos 6). When the heat pump starts, and during rapid temperature changes, you can sometimes see bubbles in the liquid in the refrigerant circuit for a minute or so. This is normal. If there are always bubbles in the sight glass: Contact the installer.



- **Expansion vessel.** A plastic expansion vessel is connected to the heat pump heat transfer fluid circuit. The level of the vessel must not fall below 1/3 (the vessel is mounted outside the heat pump).  
**Too low fluid level:** With the pump working, remove the lid to the valve at the top of the vessel and open the valve. Fill with antifreeze or clean water (simplest with a watering can). Shut the valve again and screw on the lid.

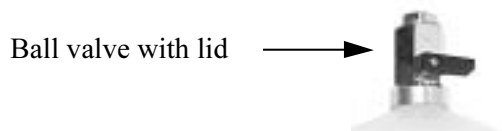

- **Particle filter** (pos 1, only built-in in the E series on the hot side). The particle filter, which is connected on both the hot and cold sides of the heat pump protect the heat exchangers from dirt. Sometimes these filters may get clogged and cause malfunctions.

Do this when checking: Shut down the heat pump with the on/off button on the control panel. Close the valve and unscrew the sealing cover. Check for dirt in the filter. If necessary, remove the circlip that retains the filter. The simplest way to do this is by using pliers. Remove the filter and flush it clean with water. Refit the filter, circlip and cover. Open the valve and start the heat pump. Note that the particle filter in the E series is mounted inside the heat pump. On the cold side and in the C and D series the filters are outside the heat pump.



## Control safety anode

(Only for models with stainless hot water cylinder)

At the top of the hot water cylinder, under the insulation, there is an electronic protection anode (standard feature) Its purpose is to prevent corrosion. The cylinder must be full of water for the anode to work.

If the heat pump is equipped with a magnesium anode, the anode can corrode depending on the water quality. If its diameter has been reduced to a minimum it must be replaced. This is how you check the magnesium anode:

1. Shut off the main cold water feed.
2. Turn on a tap to reduce the pressure in the water cylinder.
3. Unscrew the anode and check it.

If the anode is electronic there is a control panel with LEDs where you can see the status of the anode. It shows a red or a green light. If the LED shows green, the anode is operating and working normally. If large amounts of hot water are drawn off (when filling a bath for instance) the LED may show a red light for a short time even though there is no fault. If the LED shows red for more than 10 hours, the anode is faulty and a service engineer must be called.



*Electronic anode*



*Control panel with LEDs*



*Magnesium anode*

## The various parts in the C series

**Please note: The picture shows a 1-phase unit.**

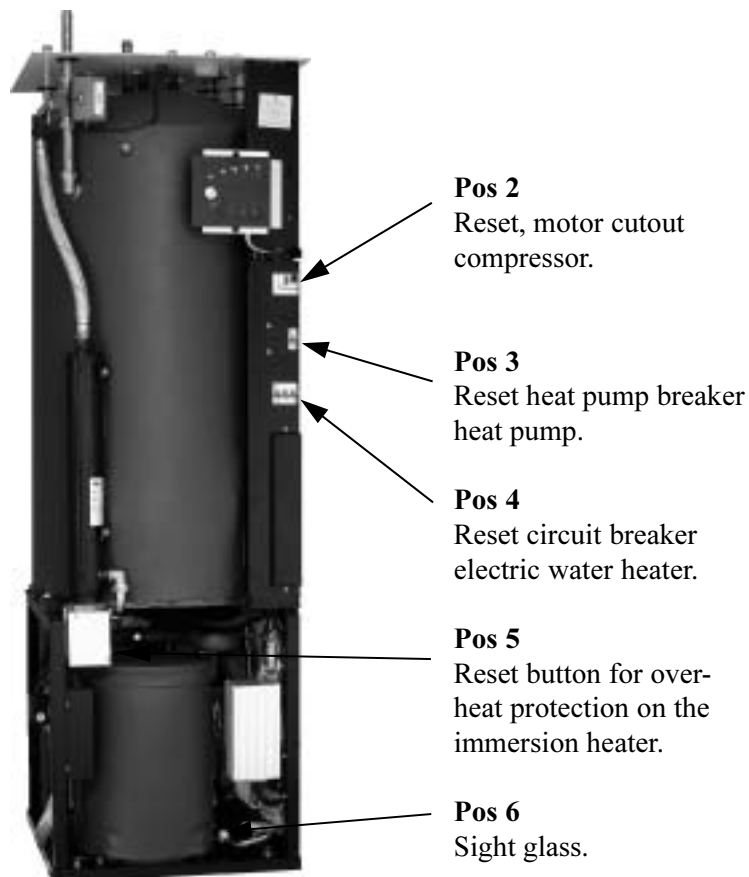

# The various parts in the D and E series

Please note: The picture is of the E series, 1-phase.

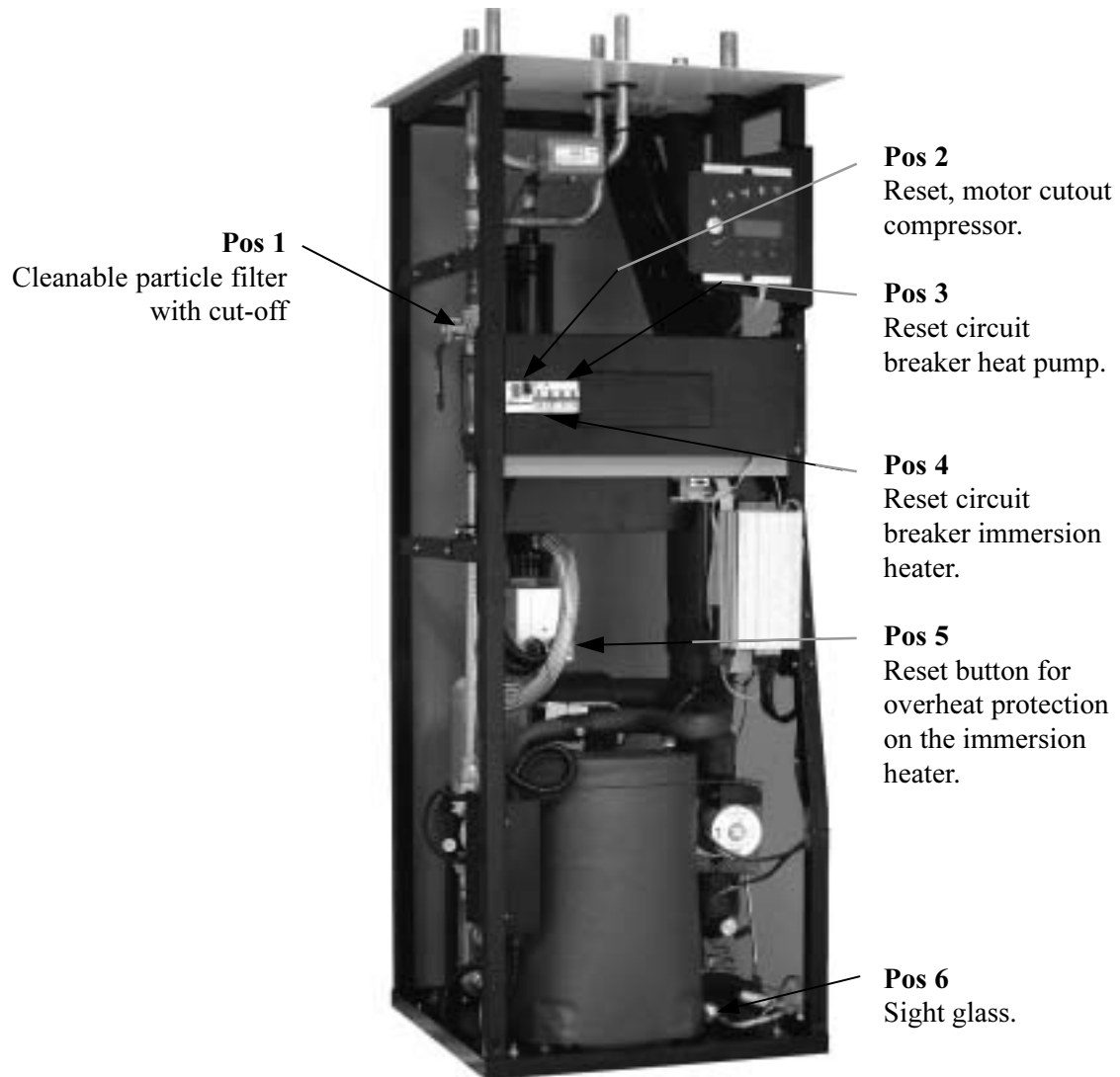

# What the shipment includes

## **Standard components**

- heat pump unit with the necessary safety functions and electrical components
- factory mounted control unit Rego600. Rego600 can be used for simultaneous operation together with an immersion heater or oil-fired or electric boiler with mixing valve.
- sensor radiator return, GT1 (packed separately).
- sensor hot water, GT3 (C series).
- sensor out, GT2 (packed separately).
- sensor, compressor, GT6.
- sensor heat transfer fluid out, GT8.
- sensor heat transfer fluid in, GT9.
- sensor heat transfer fluid (collector ) in, GT10.
- sensor heat transfer fluid (collector ) out, GT11.
- pump for heat transfer fluid and heat transfer circuits.
- built-in, flexible hoses on the heat transfer circuit.
- particle filter with shut off for heating and heat transfer fluid side (packed separately in C and D series).
- expansion vessel and safety valve for heat transfer fluid circuit (packed separately).
- soundproof cover on compressor

## **Accessories**

- sensor hot water, GT3 (D and E series).
- sensor flow duct mixing curve, GT4.
- room sensor, GT5.

# General

## **Temperatures**

Note that the heat pump can work to a maximum return temperature of around 48°C. Anything over this and the heat pump stops for safety reasons. The maximum outgoing temperature from the heat pump is around 55°C. A higher temperature can be achieved using an immersion heater.

## **Particle filter**

The particle filter supplied must *always* be fitted in the input pipe of the hot side as close as possible to the heat pump, and horizontally. The filter is mounted on the heat transfer side in the E series. The filters is separately packed on the heat transfer fluid side.

## **Transportation**

The heat pump must always be transported and stored upright and dry. The heat pump can be placed on its back temporarily for moving into place of installation.

## **Positioning**

Place the heat pump on a flat base and adjust the rubber feet until it is level. Avoid installing the heat pump close to sensitive walls such as bedroom walls, since the pump produces a certain amount of noise when running. The room must have a floor drain. Installation must comply with local construction regulations.

# Dimensions and connections, C series

Dimensions are given in mm

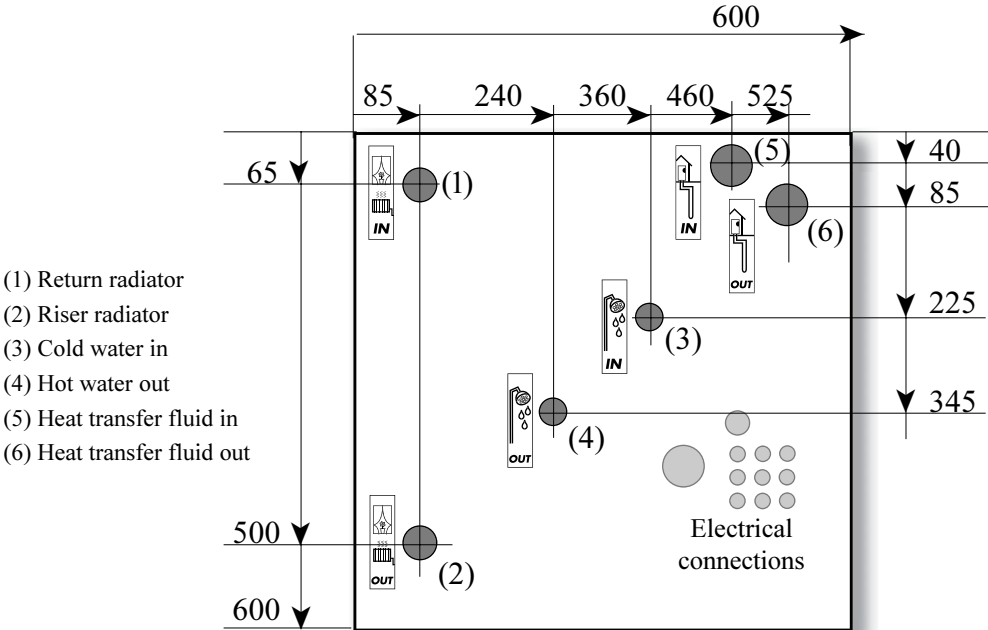
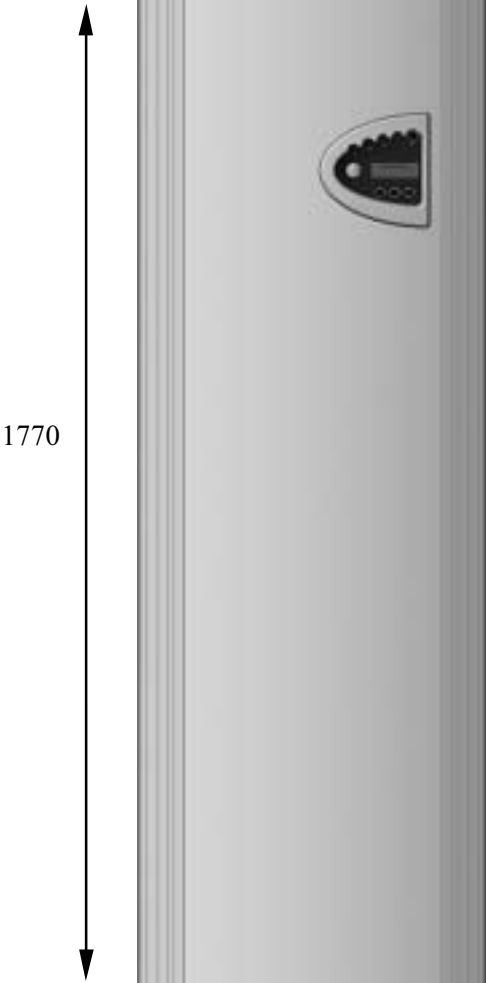

- (1) Return radiator
- (2) Riser radiator
- (3) Cold water in
- (4) Hot water out
- (5) Heat transfer fluid in
- (6) Heat transfer fluid out

Front

# Dimensions and connections, D and E series

Dimensions are given in mm

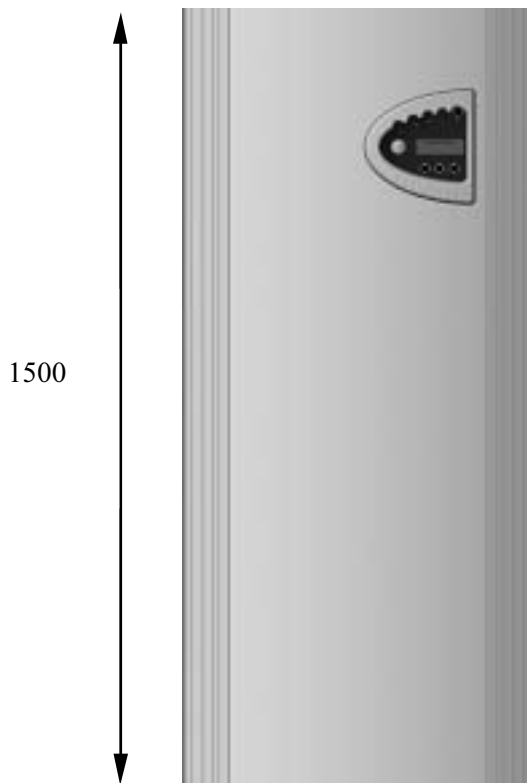

- (1) Return radiator
- (2) Riser radiator
- (3) Return DHWC
- (4) Riser DHWC
- (5) Heat transfer fluid out
- (6) Heat transfer fluid in

The D series does not have Pos. 3 and 4

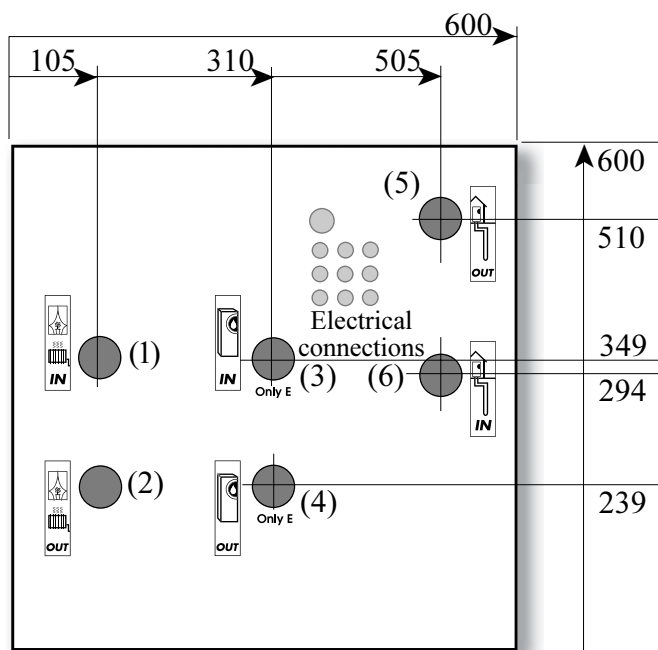

Front

# Collector

## Collector hose

The collector hose consists of a thin-walled plastic hose of make Pem 40 x 2.4 DN 6.3. Length and depth as in IVT:s dimensioning program.

Install the hose rising towards the heat pump to avoid air pockets.

It is vitally important that the filling around the ground coil does not contain stones or other objects that could damage the coil. The final filling is best carried out after the ground collector has been pressure tested. Avoid chips or dirt getting into the coil when cutting.

Installation and filling around the collector hose must comply with local regulations.

## Bending diameter

Minimum bending diameter permitted is 1 metre. Always use an elbow coupling for sharper bends. If you damage the hose by bending it too sharply you can repair it with a pipe joint.

## Maximal lengths

Specified pressure drop and hose lengths are based on heat transfer fluid containing 29 volume percent ethanol. Other heat transfer fluids are not recommended because they give high pressure drop at low temperatures. The table shows the maximum hose length for each heat pump model. The coils can be parallel connected if the collector's length exceeds that permitted for a circuit. Note that maximum hose length per coil is specified for parallel connecting. The table specifies that e.g. a Greenline 11 has a maximum coil length of 400 metres and for 2 parallel coils the length is 800 metres a coil, a total of 1,600 metres.

Heat pump:	Max. hose length with one loop	Max. hose length per coil with two loops
Greenline C4 (hose 32 x 2.5)	180 metres	360 metres
Greenline C4	500 metres	1,000 metres
Greenline C5/D5/E5	500 metres	1,100 metres
Greenline C7/D7/E7	400 metres	800 metres
Greenline C9/D9/E9	400 metres	800 metres
Greenline D11/E11	400 metres	800 metres



## Connecting the collector to the heat pump

The sketch shows the connection of a collector with two parallel coils. Both coils are connected to two distributors. Each coil should have a gate valve and a control valve. The control valve is adjusted so that the flow is the same in both coils.

The joint pipe to the heat pump is fitted with a filling unit, a particle filter and an expansion vessel. A safety valve is fitted to the outgoing duct. When refilling with the heat transfer fluid circuit, a coil at a time is filled by shutting both valves completely.

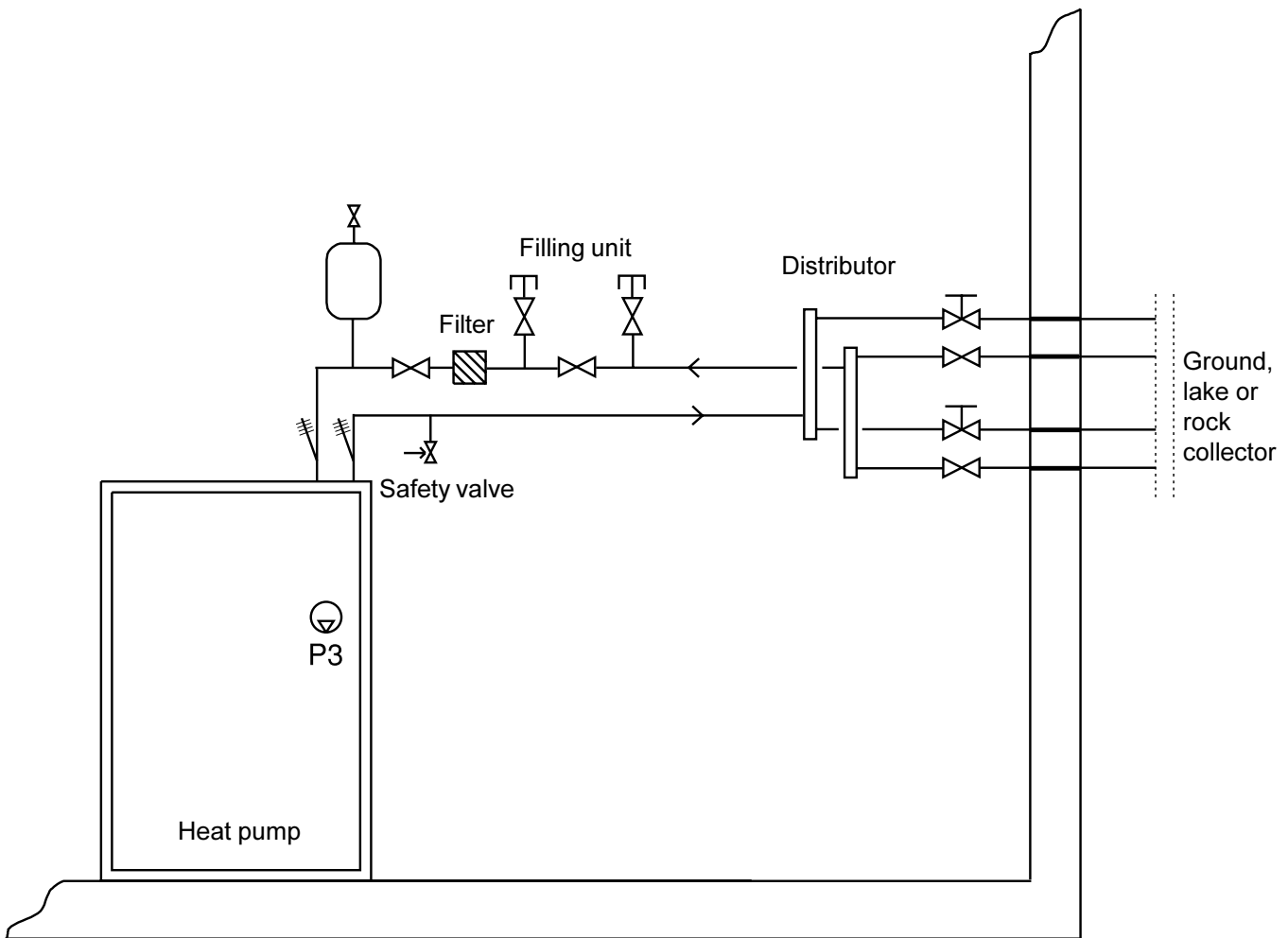

## Switching to side mounting of the heat transfer fluid system

When delivered Greenline Compact is designed for top mounting on the heat transfer fluid (collector) side. This can be changed to side mounting on the right or left side. The following instructions describe the process step by step. We recommend that rebuilding is completed before placing the heat pump in its place of installation.

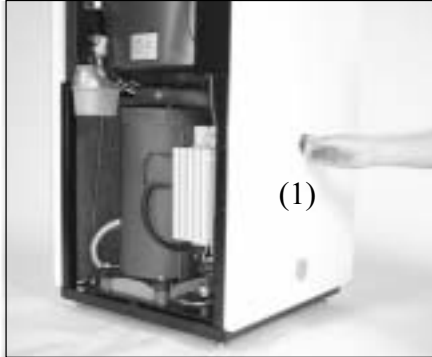

The right side plate has two connection points. Swap right and left side plates if you want to connect on the left side. Remove the plastic plugs from the sideplate (1) and put them in the holes on the roof cover panel (2).

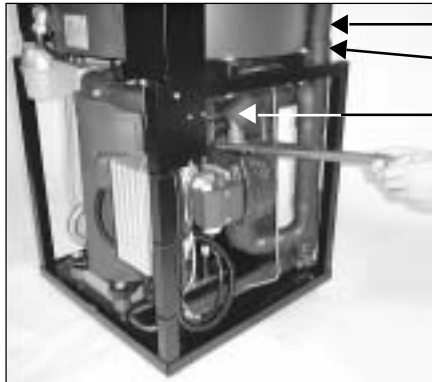
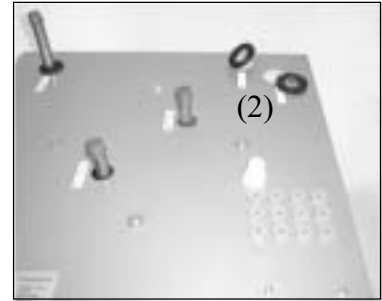

Heat transfer fluid out  
Sensor removed  
Heat transfer fluid in

Remove both the heat transfer fluid pipes that go to the top of the top plate. Heat transfer fluid in is equipped with a connector on top of the heat transfer fluid pump. Heat transfer fluid out is connected to the bottom of the heatexchanger. **Note** that the sensor on heat transfer fluid out must first be removed.



The Armaflex insulation is removed from both pipes when removing the heat transfer fluid pipe from the heat pump.



Both heat transfer fluid pipes are cut to suit left or right mounting. The following series of pictures provide the exact measurements. The pipes are cut the same whether they are left or right mounting.

Heat transfer fluid in

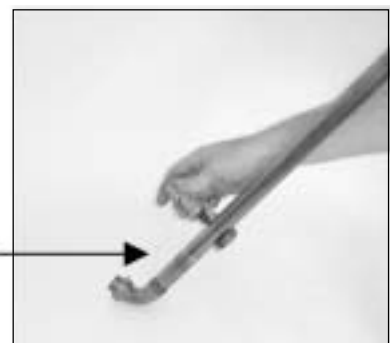

Heat transfer fluid out

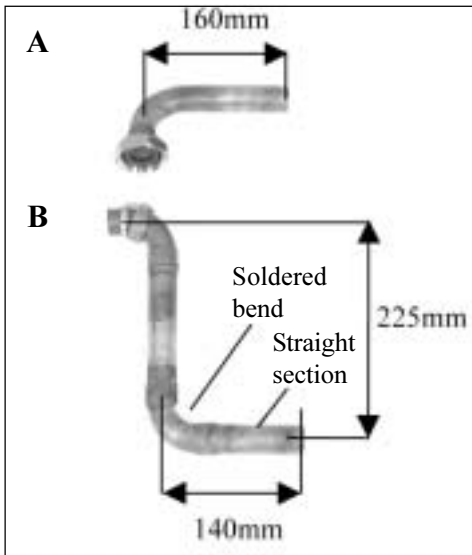

**RIGHT MOUNTING**

- Heat transfer fluid in is cut as shown in figure A.
- Heat transfer fluid out can be cut as shown in figure B then a bend and a straight piece of copper pipe can be soldered in.

The piece of pipe can be taken from the piece that was over when the pipe was cut.

Do not use compression fittings because of the lack of space in the heat pump.

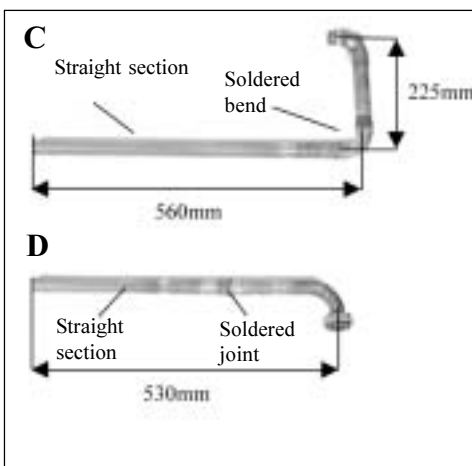

**LEFT MOUNTING:**

- Heat transfer fluid out is cut as shown in figure C then a bend and a straight piece of pipe are soldered in.
- Heat transfer fluid in is cut as shown in figure D then a joint and a straight piece of pipe are soldered in.

You can use material that was over when the pipe was cut.

Do not use compression fittings because of the lack of space in the heat pump.

**Right mounting**



- When the pipes have been adjusted they are mounted in place again.
- The sensor is mounted back on the heat transfer fluid out with a piece of aluminium tape.
- The armafex insulation is pushed back onto both pipes. Use a piece of armafex tape to cover the pipe properly to avoid condensation.

The picture on the left shows the heat transfer fluid pipe mounted on the right before the armafex insulation is mounted.

**Left mounting**



View from left and right





## Connecting the C series to the heating system and operating mode A

### Application:

The principle for operating mode A is based on liquid condensation and additional heat from an electric water heater. The built-in control unit Rego600 controls the heat pump with an outdoor sensor GT2 and return sensor GT1 according to outdoor compensated control curve. When the heat pump is not able to meet the heating requirements, additional heat starts that together with the heat pump provides the required temperature. Hot water is prioritised and controlled by a sensor, GT3 in the hot water heater. While the heat pump is heating the water in the immersion heater, the heating system is disconnected temporarily through the three-way valve. Radiator operation continues when the immersion heater is hot enough.

Rego600 can also control other curves together with a mixing valve. The mixer curve must be set lower than the curve for the rest of the heating system. This extra function is used e.g. for floor heating systems that demand a lower temperature.

### Connecting the sensors:

External sensors GT1 and GT2 must *always* be connected. Sensor GT4 is connected if the mixer curve is used and GT5 if the room sensor is required.

### \*Acc. tank:

A 100-300-litre accumulator tank is recommended for systems with separate controls for e.g. floor heating, to ensure good operational times for the heat pump. For this solution, GT1 is mounted in accordance with \*GT1.

(X) The distance between both cut offs must not be more than 10 times the dimension of the pipe.

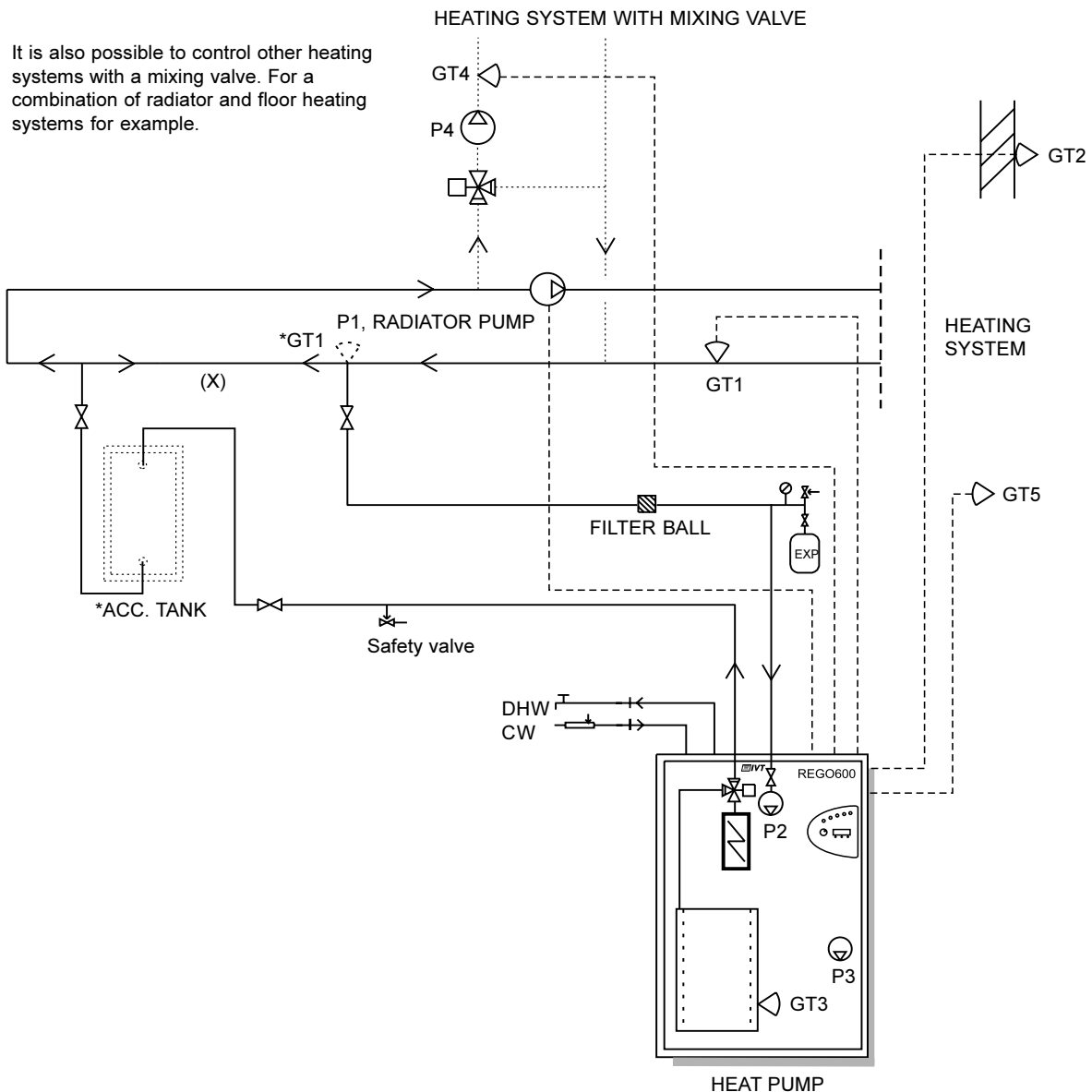

## Connecting the D series to the heating system and operating mode A

### Application:

The principle for operating mode A is based on liquid condensation and additional heat from an immersion heater. The built-in control unit Rego600 controls the heat pump with an outdoor sensor GT2 and return sensor GT1 according to outdoor compensated control curve. When the heat pump is not able to meet the heating requirements, the water heater starts automatically and together with the heat pump provides the required temperature. Hot water is prioritised and controlled by a sensor, GT3 in the hot water heater. While the heat pump is heating the water in the immersion heater, the heating system is disconnected temporarily through the 3-way valve. Radiator operation continues when the immersion heater is hot enough.

Rego600 can also control other curves together with a mixing valve. The mixer curve must be set lower than the curve for the rest of the heating system. This extra function is used e.g. for floor heating systems that demand a lower temperature.

### Connecting the sensors:

External sensors GT1 and GT2 must *always* be connected. GT3 is connected if the heat pump is to produce hot water. Sensor GT4 is connected if the mixing valve curve is going to be used and GT5 if the room sensor is required.

### \*Acc. tank:

A 100-300-litre accumulator tank is recommended for systems with separate controls for e.g. floor heating to ensure good operational times for the heat pump. For this solution, GT1 is mounted in accordance with \*GT1.

(X) The distance between both cut offs must not be more than 10 times the dimension of the pipe.

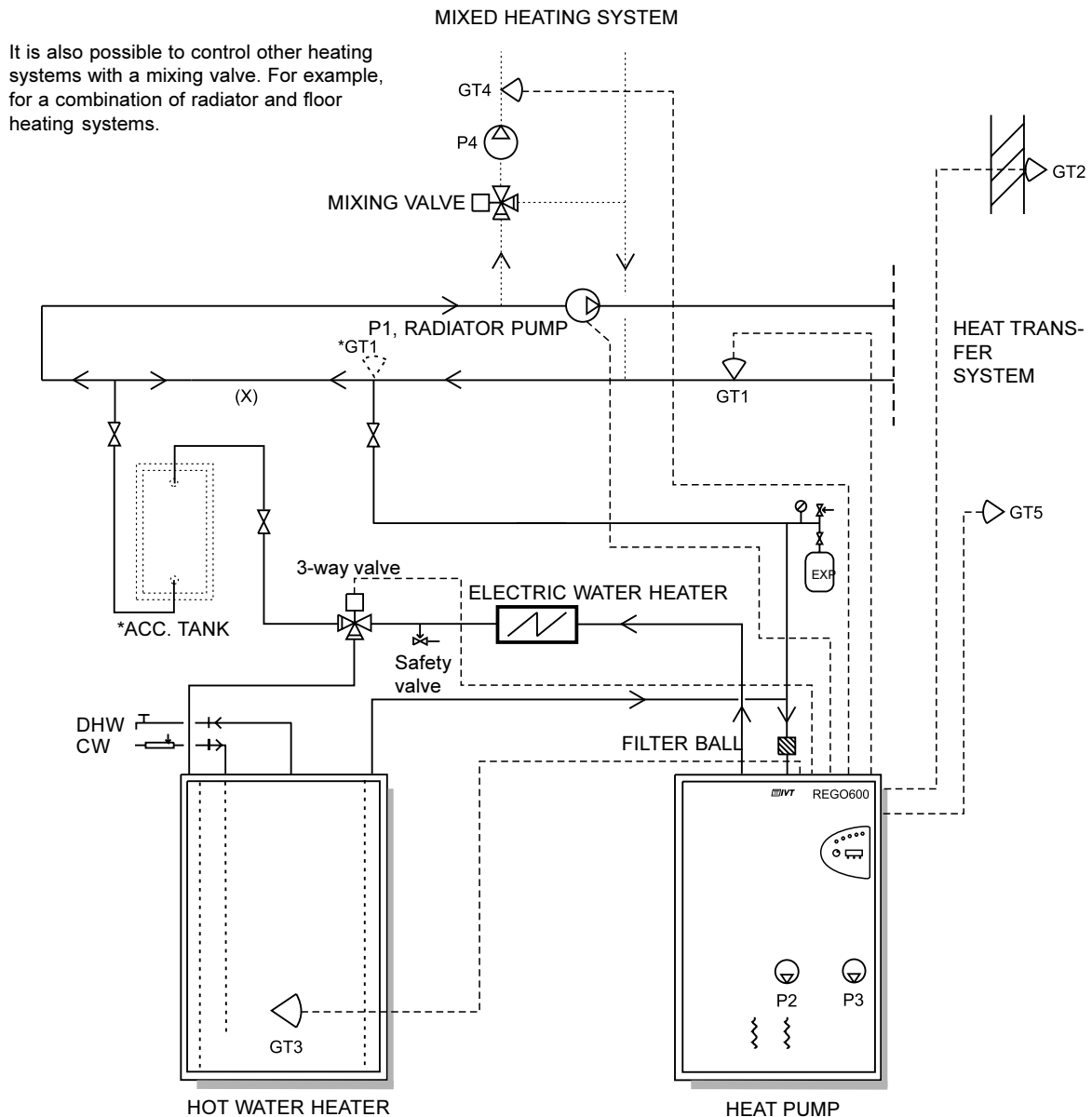

## Connecting the E series to the heating system and operating mode A

### Application:

The principle for operating mode A is based on liquid condensation and additional heat from an immersion heater. The built-in control unit Rego600 controls the heat pump with an outdoor sensor GT2 and return sensor GT1 according to outdoor compensated control curve. When the heat pump is not able to meet the heating requirements, the water heater starts automatically and together with the heat pump provides the required temperature. Hot water is prioritised and controlled by a sensor, GT3 in the hot water heater. While the heat pump is heating the water in the immersion heater, the heating system is disconnected temporarily through the 3-way valve. Radiator operation continues when the immersion heater is hot enough.

Rego600 can also control other curves together with a mixing valve. The mixer curve must be set lower than the curve for the rest of the heating system. This extra function is used e.g. for floor heating systems that demand a lower temperature.

### Connecting the sensors:

External sensors GT1 and GT2 must *always* be connected. GT3 is connected if the heat pump is to produce hot water. Sensor GT4 is connected if the mixer curve is used and GT5 if the room sensor is required.

### \*Acc. tank:

A 100-300-litre accumulator tank is recommended for systems with separate controls for e.g. floor heating to ensure good operational times for the heat pump. For this solution, GT1 is mounted in accordance with \*GT1.

(X) The distance between both cut offs must not be more than 10 times the dimension of the pipe.

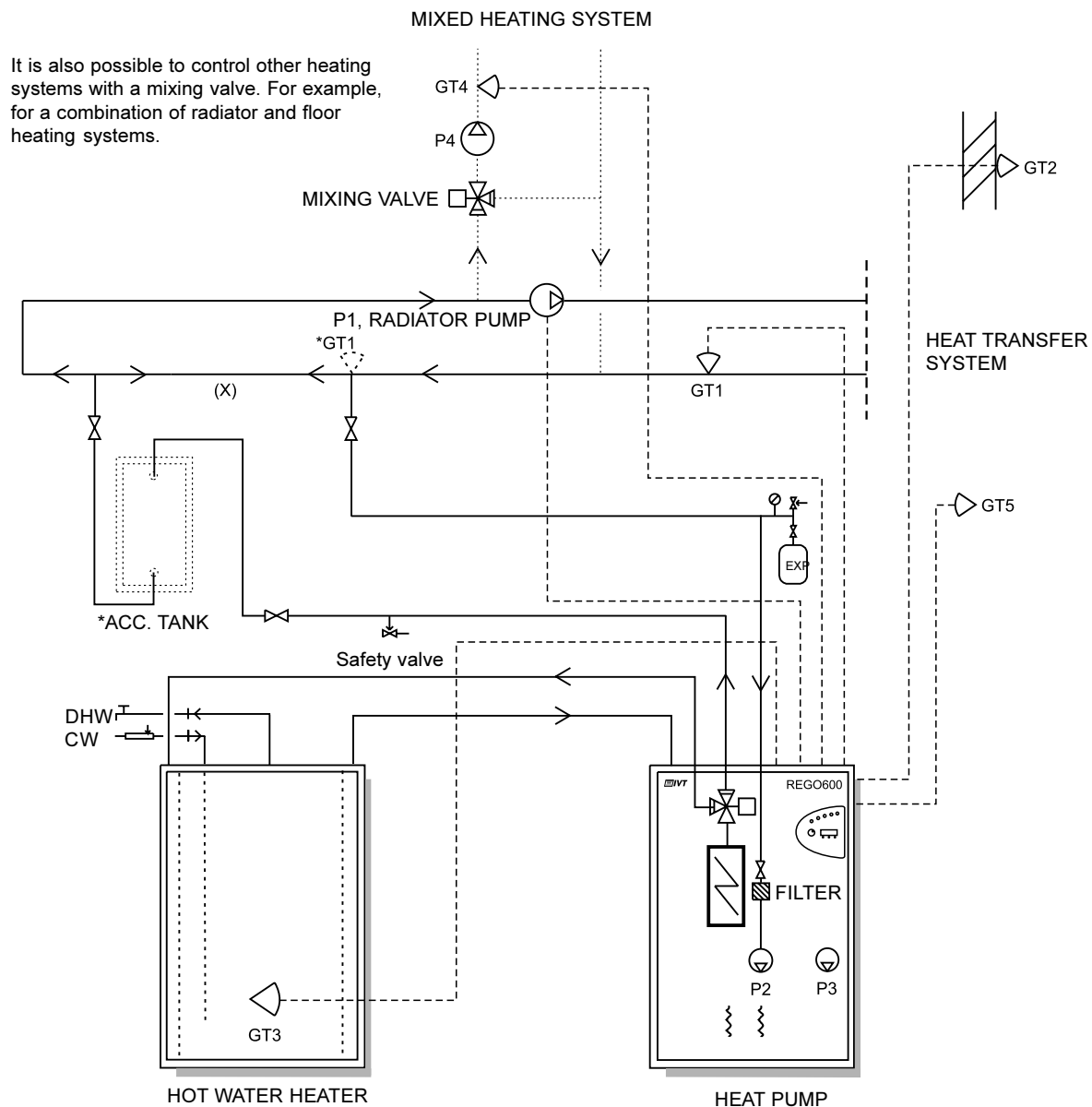

## Connecting the D series to the heating system and operating mode B

### Application:

The principle for operating mode B is based on liquid condensation and additional heat from an oil-fired boiler using a mixing valve. The built-in control unit Rego600 controls the heat pump with an outdoor sensor GT2 and return sensor GT1 according to outdoor compensated control curve. When the heat pump is not able to meet the heating requirements, the oil-fired boiler starts automatically and together with the heat pump provides the required temperature. Hot water is prioritised and controlled by a sensor, GT3 in the hot water heater. While the heat pump is heating the water in the immersion heater, the heating system is disconnected temporarily through the 3-way valve. If the oil-fired boiler is in operation it provides the required temperature to the radiator system. Radiator operation continues when the immersion heater is hot enough.

### Connecting the sensors:

External sensors GT1 and GT2 must *always* be connected. GT3 is connected if the heat pump is to produce hot water. GT5 if use of a room sensor is required.

### \*Acc. tank:

A 100-300-litre accumulator tank is recommended in systems with separate controls for e.g. floor heating to ensure good operational times for the heat pump. For this solution, GT1 is mounted in accordance with \*GT1.

(X) The distance between both cut offs must not be more than 10 times the dimension of the pipe.

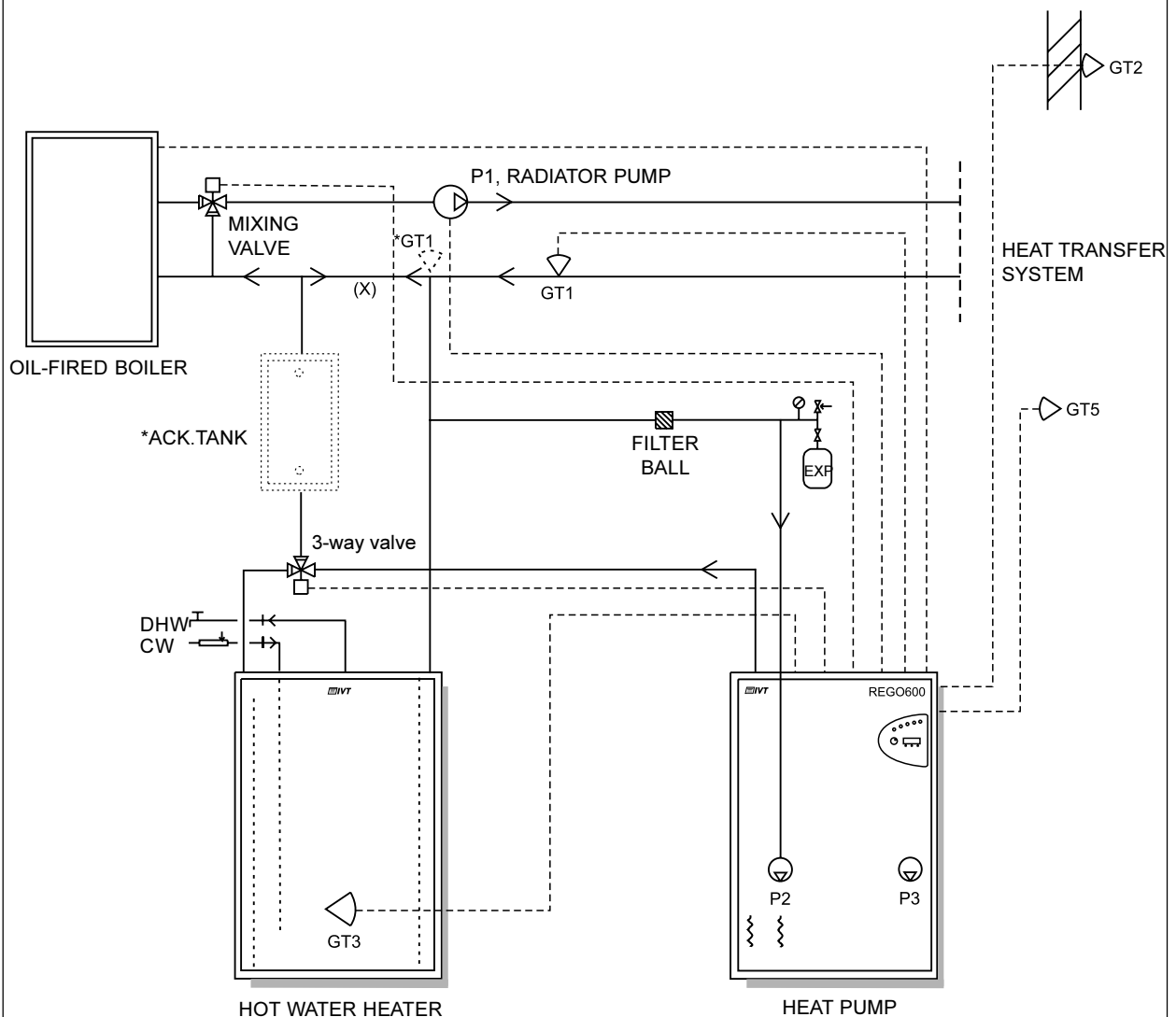



## Connecting the D series to the heating system and operating mode C

### Application:

The principle for operating mode C is based on a fixed temperature and additional heat from an immersion heater. Rego600 controls the heat pump with a built-in return sensor, GT9. When the heat pump is not able to meet the heating requirements, the water heater starts automatically and together with the heat pump provides the required temperature. The hot water is produced in an external double shelled heater. The heating is controlled by a mixing valve controlled by a flow sensor GT4 and an outdoor sensor GT2. This is not an optimal solution for the heat pump because the heat pump works up to its max temperature all year round with inferior efficiency as a result.

### Connecting the sensors:

External sensors GT1 and GT2 must *always* be connected. GT5 if use of a room sensor is required.

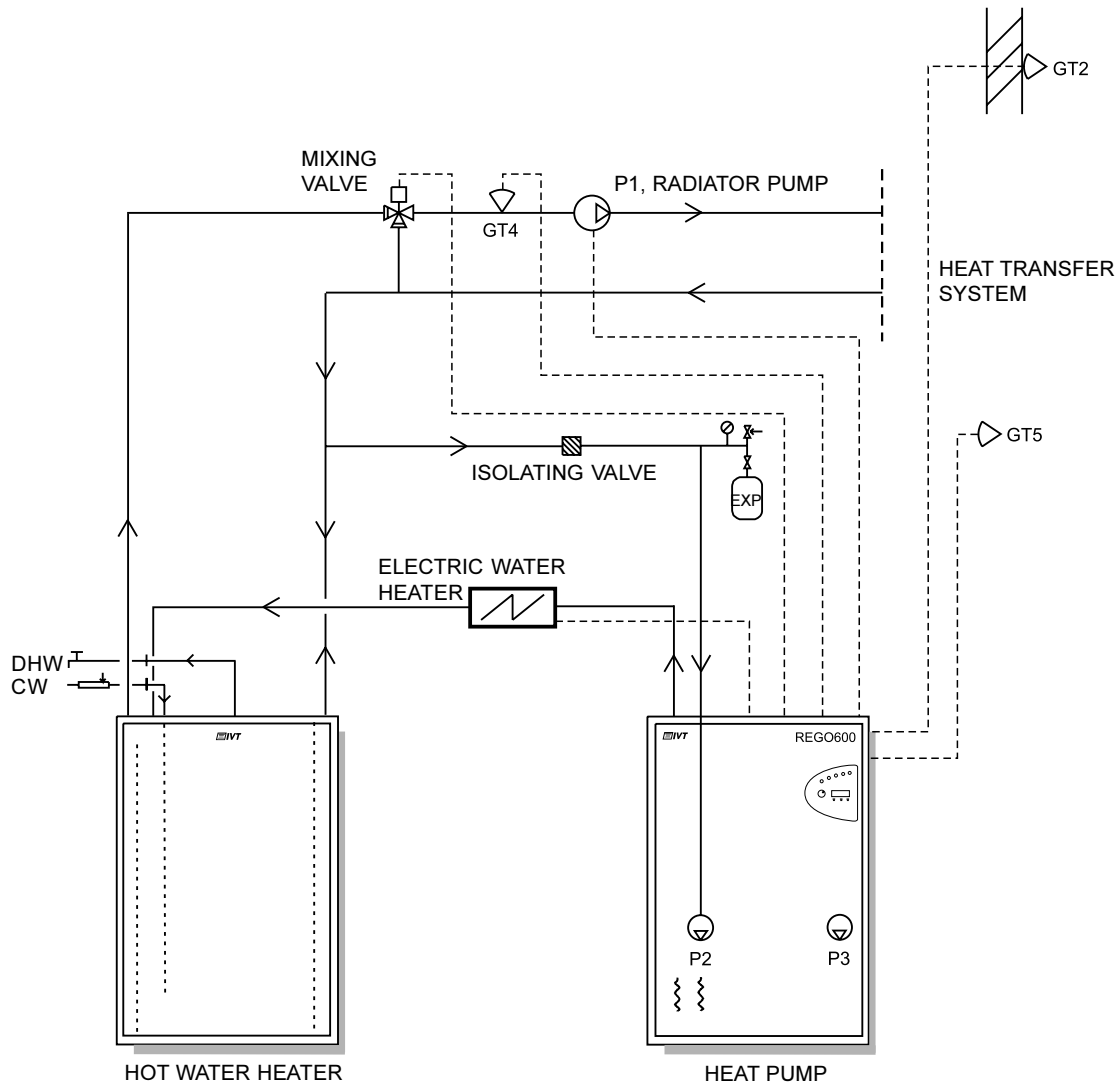

## Connecting the 3-way valve

Connecting a Honeywell 3-way valve to hot water cylinder.

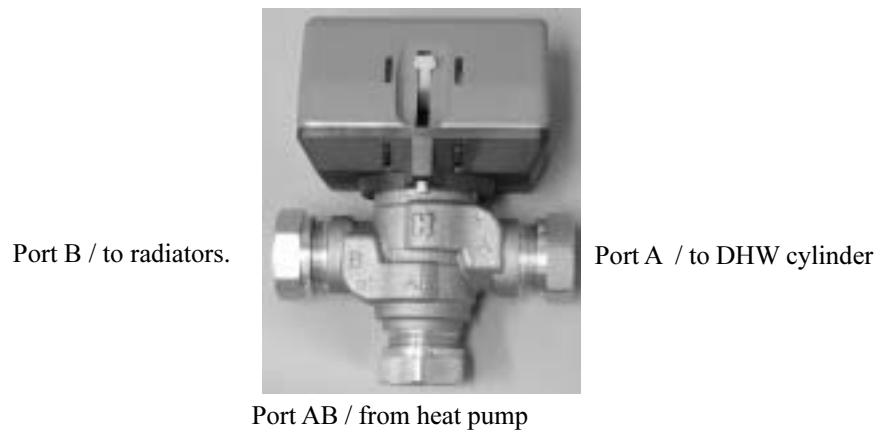

## Filling the radiator system

Note that the radiator system must have its own expansion vessel. Open the valve between the cold water system and the heating system in short bursts and then close it and note the pressure gauge reading. When the system is full or the right pressure has been reached, vent the system and top it up if necessary.

## Filling of heat transfer fluid

The ground coil or well coils must be filled with a mixture of water and heat transfer fluid until a freeze protection level of around  $-15^{\circ}\text{C}$  is reached as shown in the following table.

Procedure when filling is (compare with the picture on the next page)

- Connect two one inch hoses to both filling valves 1 and 2. One hose has a submersible pump (min  $6 \text{ m}^3/\text{h}$ ) connected at the other end.
- Both hoses are placed in a barrel with a volume of at least 100 litres. The barrel is filled with a mixture of antifreeze and water. As shown in the table on the next page. Always fill water before antifreeze.
- Open valves 1 and 2, shut valve 3. Start the submersible pump (that is equipped with a particle filter!), and the system fills with liquid. *Note* that the first litres in the return pipe are usually contaminated. So collect the first litres in a separate vessel.
- Open the expansion vessel valve until the vessel fills to around  $2/3$ .
- When the level in the barrel has sunk to 25% the submersible pump stops and the barrel fills with the antifreeze mixture.
- When the system is full and air is no longer coming from the return pipe the system is for a further 30 minute at least. You can start the heat pump's heat transfer fluid pump to speed up the air venting. Go into manual operation in display 5.3 and start pump P3.
- When venting is ready open valve 3, shut valve 2, and shortly after valve 1. Disconnect the hoses and the transfer fluid side is ready for operation. *Note* that a little overpressure in the transfer fluid circuit is beneficial.

**The table shows the mixture in volume litre/ metre**

Hose type / Antifreeze type	40/35		32/28	
	Litres of water	Litres of antifreeze	Litres of water	Litres of antifreeze
Ethanol	0.71	0.29	0.42	0.18
Propylene	0.65	0.35	0.39	0.21

**The table shows the mixture in weight percent**

Hose type	40/35	32/28
Ethanol	25%	
Propylene	35%	

**Example** 200 metres of hose type 40/35 with Brinol gives  $200 \times 0.29$  litres Brinol/ metre = 58 liter Brinol and  $200 \times 0.71$  litres water/ metres = 142 litres water.

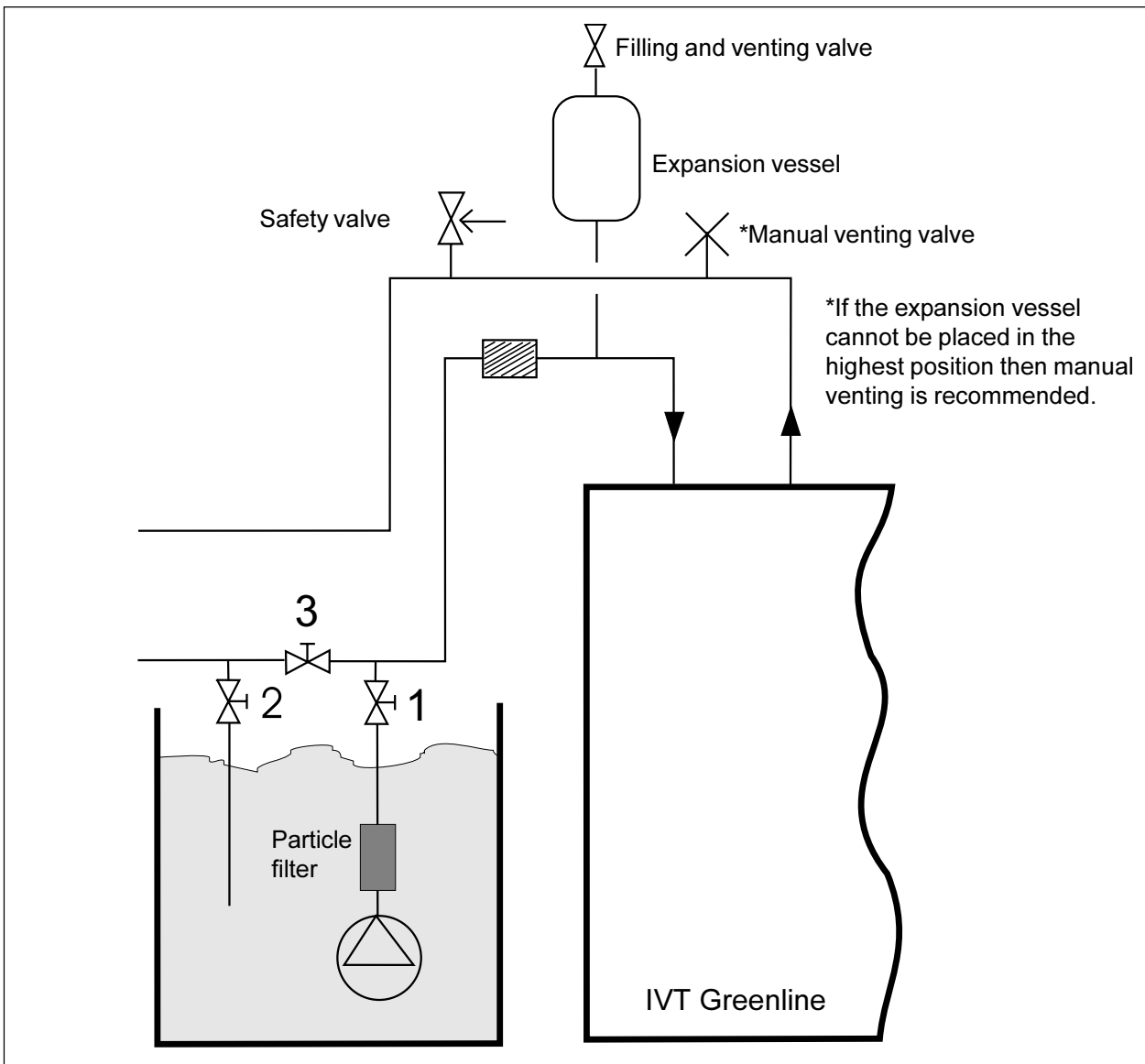

# Circuit diagram Greenline C4 3x400V

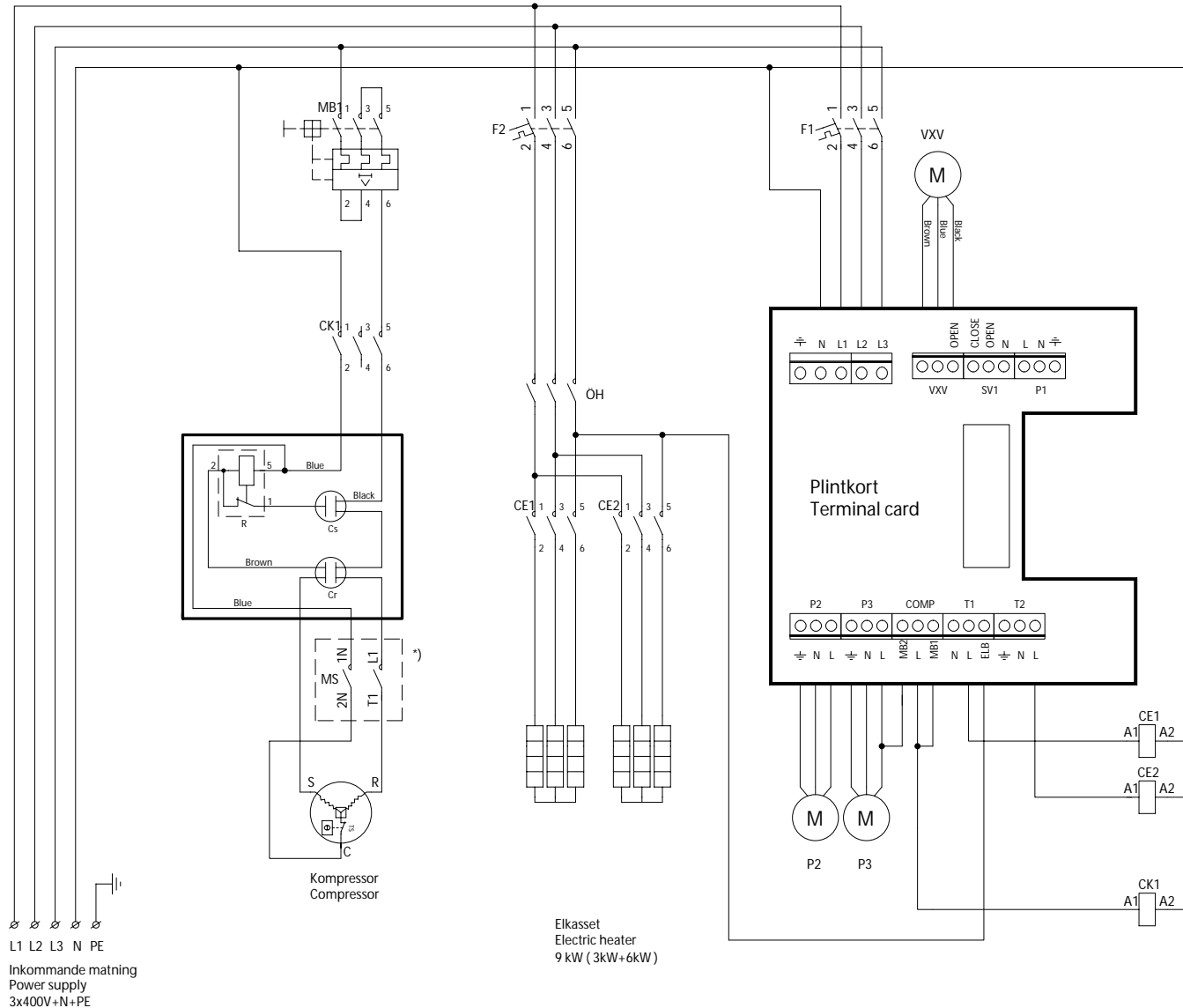

## Givarkort interna kopplingar Sensor Board internal couplings

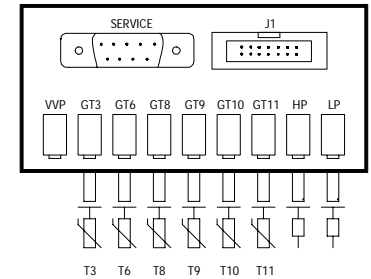

- T3: Varmvatten/ Hot water
- T6: Kompressor/ Compressor
- T8: Värmebärare ut/ Heat transfer fluid out
- T9: Värmebärare in/ Heat transfer fluid in
- T10: Köldbärare in/ Heat transfer fluid (coll) in
- T11: Köldbärare ut/ Heat transfer fluid (coll) out
- HP: Pressostat hög/ High pressure switch
- LP: Pressostat låg/ Low pressure switch

- MB1: Motorskydd kompressor/  
Motor cutout compressor
- CK1: Kontaktor kompressor/  
Contactor compressor
- CE1: Kontaktor Elkasset 1/  
Contactor electric heater 1
- CE2: Kontaktor Elkasset 2/  
Contactor electric heater 2
- F1: Automatsäkring värmepump/  
Circuit breaker heatpump
- F2: Automatsäkring elkasset/  
Circuit breaker electric heater
- OH: Överhettningsskydd elkasset/  
Overheat cutout electric heater
- Cr: Driftkondensator / Run capacitor
- Cs: Startkondensator / Start capacitor
- R: Startrelä / Potential relay

\*) MS: Mjukstart, tillbehör  
Softstarter, accessories

# Circuit diagram Greenline C5-C9 3x400V

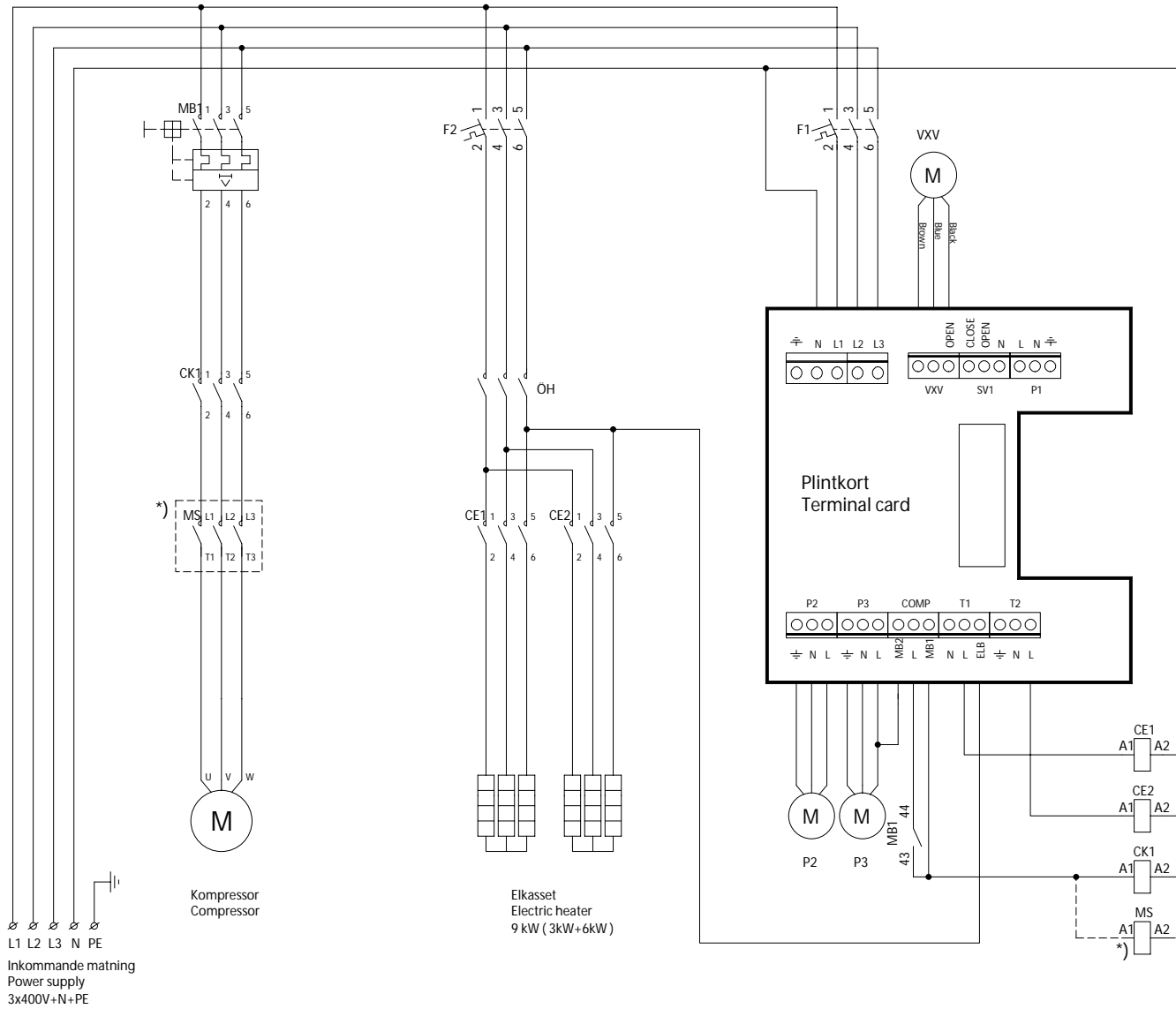

## Givarkort interna kopplingar Sensor Board internal couplings

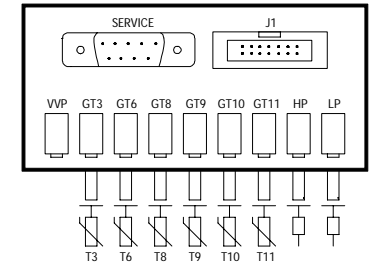

- T3: Varmvatten/ Hot water
- T6: Kompressor/ Compressor
- T8: Värmebärare ut/ Heat transfer fluid out
- T9: Värmebärare in/ Heat transfer fluid in
- T10: Köldbärare in/ Heat transfer fluid (coll) in
- T11: Köldbärare ut/ Heat transfer fluid (coll) out
- HP: Pressostat hög/ High pressure switch
- LP: Pressostat låg/ Low pressure switch

- MB1: Motorskydd kompressor/  
Motor cutout compressor
- CK1: Kontaktor kompressor/  
Contactor compressor
- CE1: Kontaktor Elkassett 1/  
Contactor electric heater 1
- CE2: Kontaktor Elkassett 2/  
Contactor electric heater 2
- F1: Automatsäkring värmepump/  
Circuit breaker heatpump
- F2: Automatsäkring elkassett/  
Circuit breaker electric heater
- OH: Överhettningsskydd elkassett/  
Overheat cutout electric heater
- \*) MS: Mjukstart, tillbehör  
Softstarter, accessories



# Circuit diagram Greenline E5-E11 3x400V

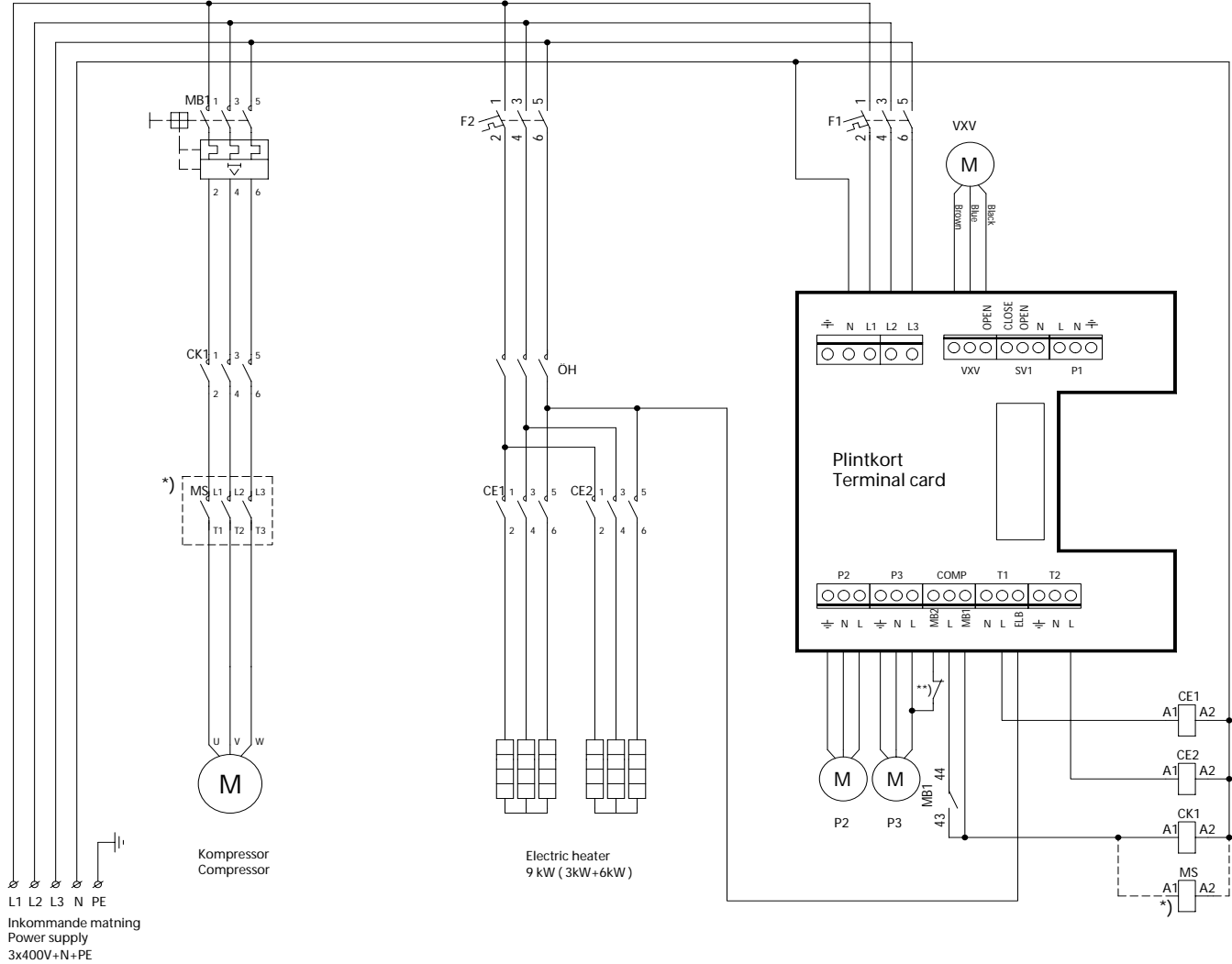

Givarkort interna kopplingar  
Sensor Board internal couplings

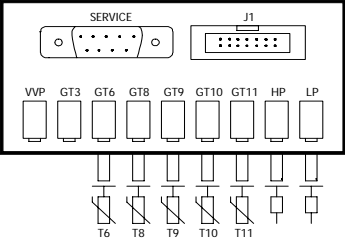

- T6: Kompressor/ Compressor
- T8: Värmebärare ut/ Heat transfer fluid out
- T9: Värmebärare in/ Heat transfer fluid in
- T10: Köldbärare in/ Heat transfer fluid (coll) in
- T11: Köldbärare ut/ Heat transfer fluid (coll) out
- HP: Pressostat hög/ High pressure switch
- LP: Pressostat låg/ Low pressure switch

- MB1: Motorskydd kompressor/ Motor cutout compressor
- CK1: Kontaktor kompressor/ Contactor compressor
- CE1: Kontaktor Elkassett 1/ Contactor electric heater 1
- CE2: Kontaktor Elkassett 2/ Contactor electric heater 2
- F1: Automatsäkring värmepump/ Circuit breaker heatpump
- F2: Automatsäkring elkassett/ Circuit breaker electric heater
- OH: Overhettningsskydd elkassett/ Overheat cutout electric heater
- \*) MS: Mjukstart, tillbehör Softstarter, accessories

\*\*) I modell 11 finns ett inbyggt motorskydd i pumpen, i modellerna 5-9 är en bygel monterad mellan L och MB2.  
Model 11 has a built-in motor cutout in the pump, models 5-9 have a clamp fitted between L and MB2.

# Circuit diagram Greenline D5-D11 3x400V

49

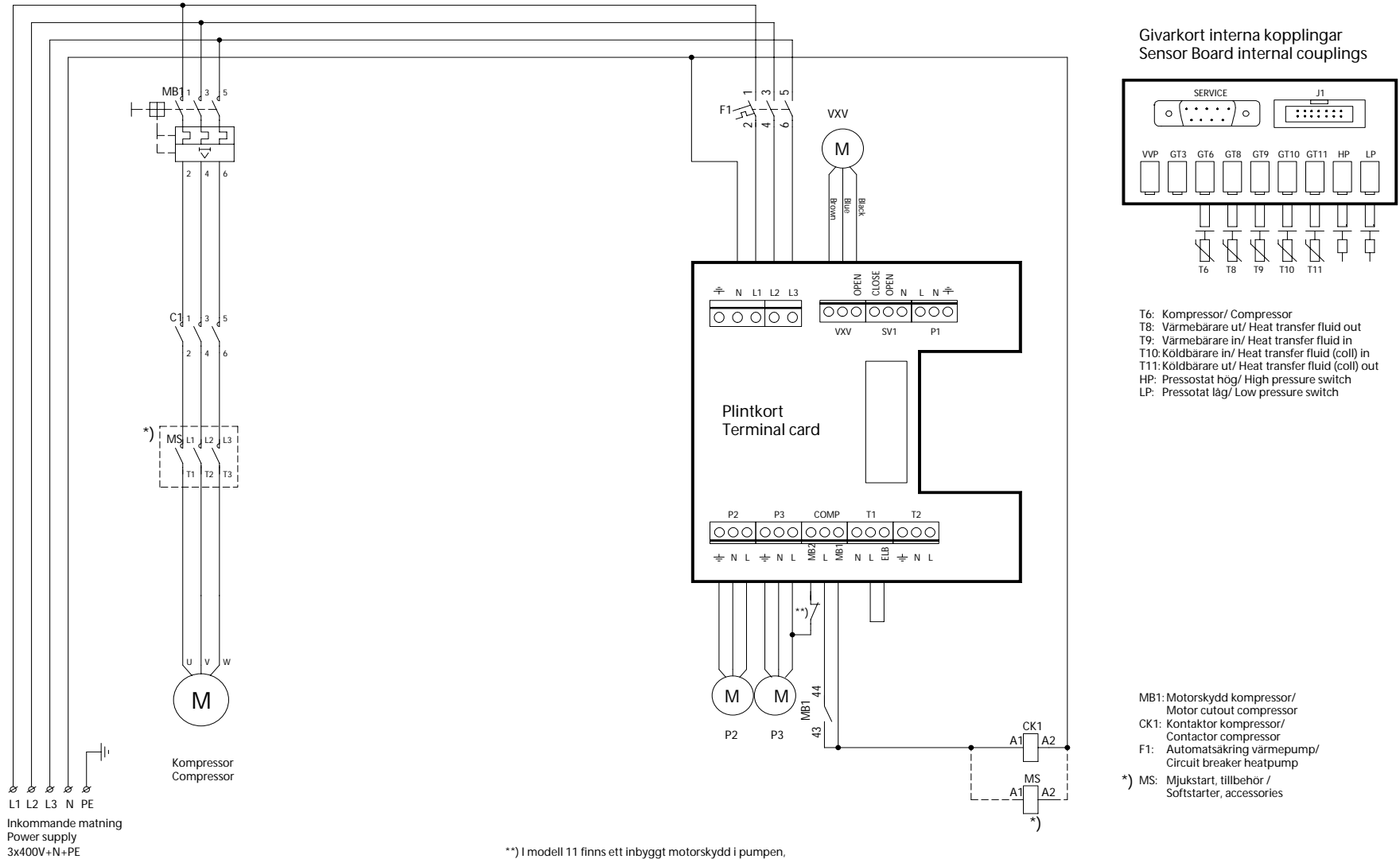



## Disconnection switch

- The heat pump must always have a main switch connected.

## Earth leakage circuit breaker

- If the heat pump is connected over a leakage circuit breaker then a separate leakage circuit breaker is recommended for the heat pump.

## External connections in the C and E series.

- Power supply:** Connect to terminals L1, L2, L3, N and PE. Alarm triggers if phases connected wrongly.
- Heating circuit with mixing valve:** If a second heat curve with mixing valve is to be used, the mixing valve is connected to terminals SV1.
- P1, external main pump in the heating system:** Must always be connected. Connected to terminals P1.
- Return sensor radiator GT1:** Must always be connected. Connected to terminals GT1.
- Outdoor sensor GT2:** Must always be connected. Connected to terminals GT2.
- Hot water sensor GT3:** GT3 is connected if the heat pump is to produce hot water. Connected to terminals GT3 X. (the C series is connected at factory).
- Mixing valve sensor GT4:** Connected if the mixing valve for the second heat curve is used. Connected to terminals GT4.
- Room sensor GT5:** Connected if room sensor influence is required. Connected to terminals GT5. If room sensor alarm is required it is connected to terminals ALARM LED.

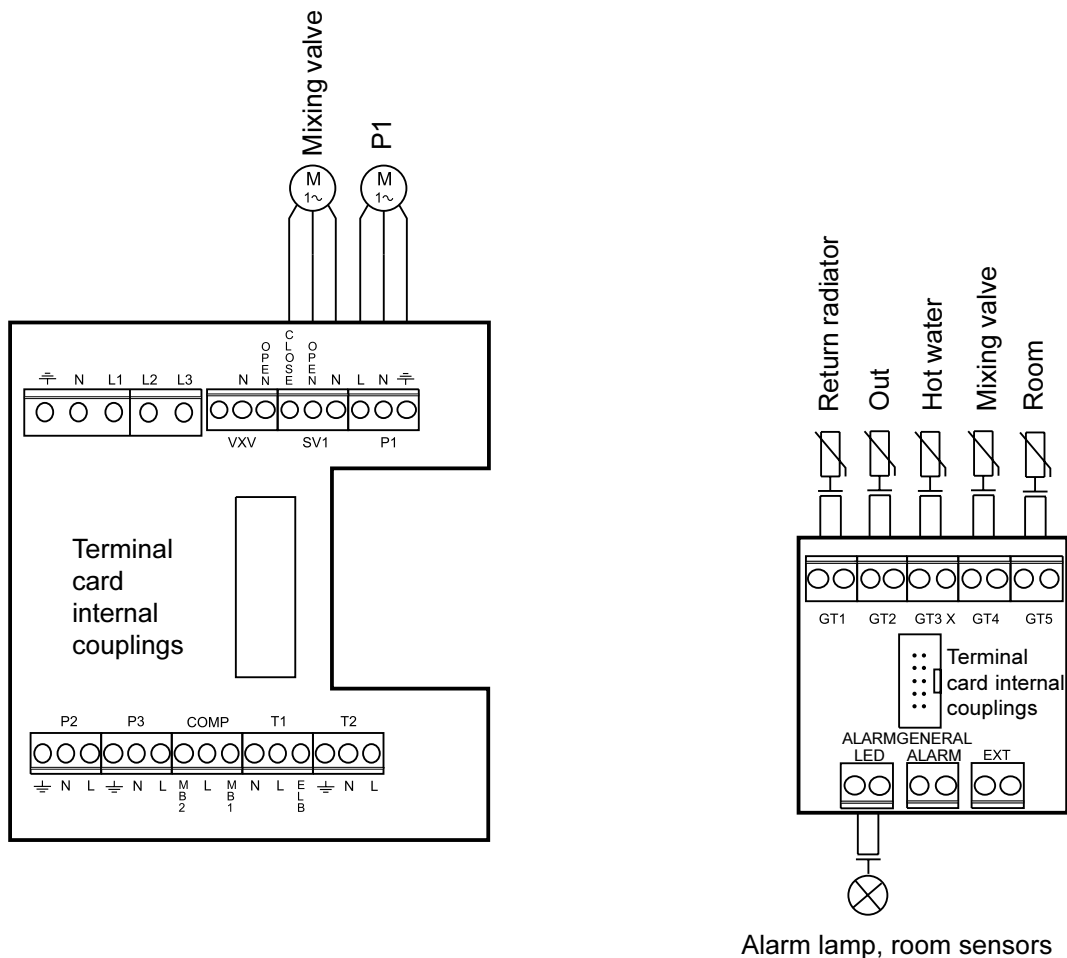

## External connections in the D series

- **Power supply:** Connect to terminals L1, L2, L3, N and PE. Alarm triggers if phases connected wrongly.
- **3-way valve:** Connected if the heat pump is to produce hot water. Connected to terminals VXV.
- **Mixing valve for oil-fired boiler:** If a mixing valve is required for the oil-fired boiler then it is connected to terminals SV1.
- **P1, external main pump in the heating system:** Must always be connected. Connected to terminals P1.
- **Return sensor radiator GT1:** Must always be connected. Connected to terminals GT1.
- **Outdoor sensor GT2:** Must always be connected. Connected to terminals GT2.
- **Hot water sensor GT3:** Connected if the heat pump is to produce hot water. Connected to terminals GT3 X
- **Room sensor GT5:** Connected if room sensor influence required. Connected to terminals ALARM LED.

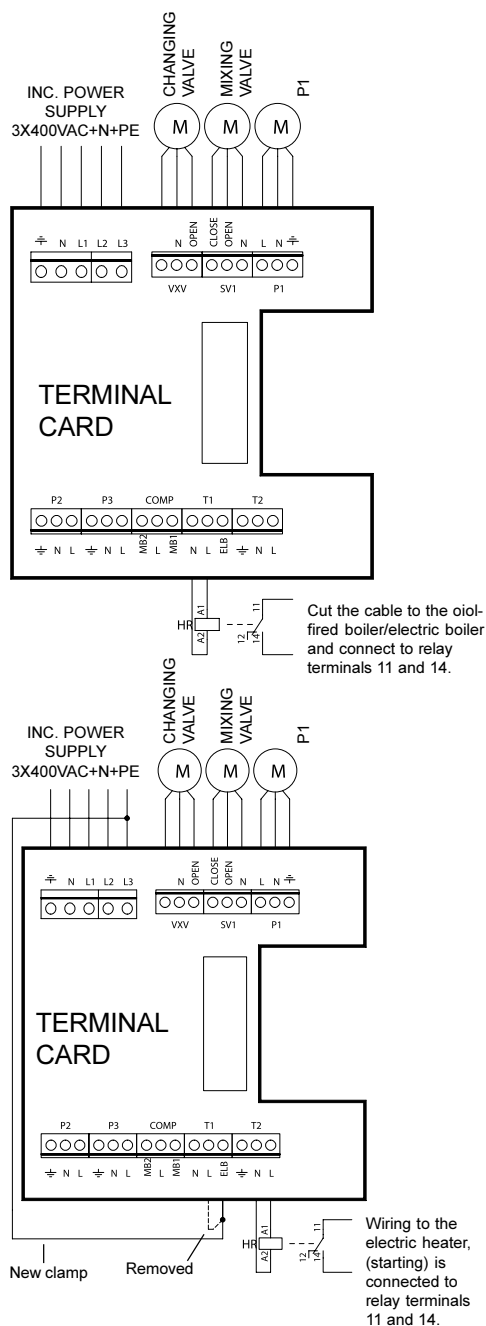
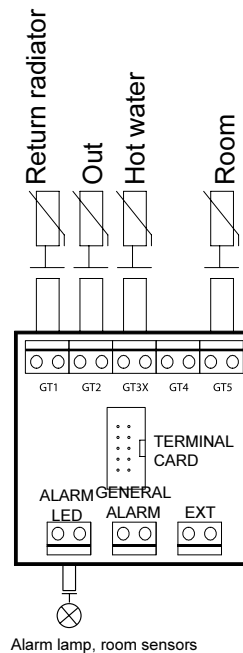

### Connection of additional heat to oil and electric boiler, operating mode B

When additional heat is from an oil-fired or electric boiler with a mixing valve the wiring to the burner or contactor is connected to terminals N and L on contact T1 via a help relay HR. L1 provides 230Vac.

If the electric boiler has an inlet for telecontrol it is connected to the help relay.

### Connecting additional heat to electric heater, operating modes A and C

If the additional heat is an electric heater it is connected in the following way: Remove the clamp between L and ELB on contact T1. Mount a new clamp between terminal L3 and ELB on contact T1. Mount the wire on help relay HR to N and L to contact T2. The electric heater's on/off is connected to the help relay terminals 11 and 14. Concerns both contactors and telecontrol function in the electric heater.

Connecting power is set at 2/3 in the 5.2 menu display

If alarm function is required for the electric heater's overheat protection the clamp between L3 and ELB should not be removed but the clamp between L and ELB. A clamp is mounted instead to ELB from the overheat protection, PLEASE NOTE! Must be phase 3. (see Circuit diagram E series)

## Connecting the general alarm

A general alarm is connected according to the sketch. The contact for the general alarm outlet is floating. Max 24 volt, 100mA. The contact shuts at joint alarm.

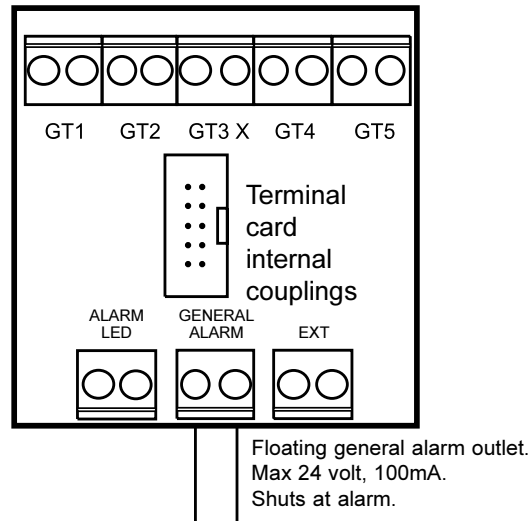

## Connecting the external input

The heat pump can be controlled by external control and be programmed in Rego600 for different functions. Function choice is available in menu display 1.13 (remote control heating) and menu display 5.7 (select external controls). The inlet is short-circuited to activate the function. You can choose between more than one alternative in display 5.7 or 1.13.

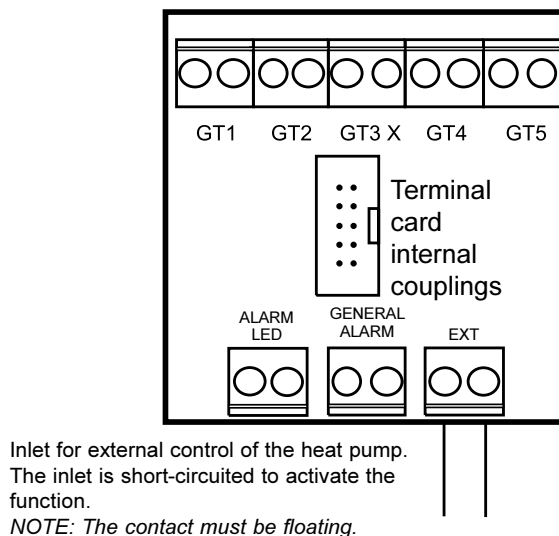

## Connecting the load monitor

A load guard can be connected to the external control input and in this way break the additional heat. You programme function 3 in menu display 5.7. When the external inlet short circuits the additional heat is broken. Heat pump operation is not affected. Connection as above. When this function is chosen no other external controls can be used.

# Control unit Rego600

If you are an installer, note that you can find certain information about the operation of the control unit in the sections that are intended for the end user. It is therefore important for installers to read the *entire* guide before putting the heat pump into service.

## Installer/service settings

As installer Installer / Service gives you access to all the menu displays that the end user has at customer levels 1 and 2. Note that the menu display is connected to the selected operating mode. You will never see displays that concern anything else but the selected operating mode.

## Installer/service menu

By keeping down Menu for 10 seconds and then enter Menu you will come to settings for installers or service companies. The Menu display is divided into lines and each display has a number to make it easy to find. You will automatically return to level 1 again after 30 seconds.

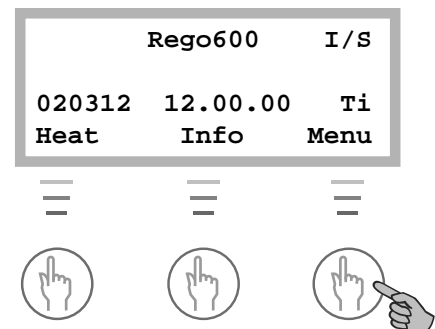

### WARNING!

Installer only. As end-user you must never go into this level!

## Joint displays for operating modes A, B and C

### Line 1

```
Temperature settings
Heat curve
adjust. (break) 1.3
Return          Select
```

Here you can “break” the heat curve up or down for each fifth degree outdoor temperature. You can e.g. do a temporary increase on the curve at 0°C outdoor temperature.

### Line 4

```
Clock setting
Clock sett. add heat
accord. to clock 4.2
Return          Select
```

You can block the additional heat totally during certain times of day. Instructions are found under the chapter on clock controls at increased customer level.

### Line 5

```
Commiss./Service
Manual operation of
all functions    5.3
Return          Select
```

When controlling functions you can here manually start and stop pumps and valves etc.

```
Commiss./Service
Fast restart
of heat pump      5.6
Return           Select
```

```
Commiss./Service
Select external
controls          5.7
Return           Select
```

```
Commiss./Service
Selection of
language meny    5.8
Return           Select
```

```
Commiss./Service
Select operation
alt. for P2      5.10
Return           Select
```

```
Commiss./Service
Select operation
alt. for P3      5.11
Return           Select
```

```
Commiss./Service
Display software
version number   5.12
Return           Select
```

```
Commiss./Service
Connected extra
sensor in op.    5.13
Return           Select
```

You can shorten the time for restarting the heatpump here. If there is a need for heating or hot water the heat pump starts within 20 seconds. The settings must be repeated each time you require quick restart.

Selecting external control of heat pump, additional heat and hot water loading. When the external inlet on Rego600 is short-circuited you can make the following choices:

0: No affect (factory setting).

1: HP, additional heat and hot water stop.

2: HP no affect, additional and hot water stop (this position must not be chosen in operating mode C).

3: HP, and hot water no affect, additional heat stops.

4: HP and additional heat no affect, hot water stops (this position must not be chosen in operating mode C).

Note that if you choose any of the above alternatives you cannot use any of the functions in 1.13 (remote control heating).

You choose language in display 5.8. "Svenska" is the factory setting.

Here you can choose to always have the heat transfer fluid pump in operation or start and stop with compressor. Continuous operation is the factory setting. This choice does not exist in operating mode C for technical reasons.

The heat transfer fluid pump should normally always start and stop with the compressor. 5.11 you can choose to let it go in continuous operation or during e.g. use of natural cooling. Factory setting is start and stop with compressor.

Display 5.12 shows you the version number of Rego600.

In display 5.13 you Ackn the extra sensors GT3, GT4 and GT5 that are connected externally. With Confirm, Rego600 memorises that the sensors are used and the heat pump then produces hot water when GT3 is selected.

## Line 6

```
Timer readings
Read
DHW peak timer    6.1
Return           Select
```

Only in  
operating  
mode A

```
Timer readings
Read
add. heat timer  6.2
Return           Select
```

```
Timer readings
Read
alarm timer      6.3
Return           Select
```

```
Timer readings
Read
start delay      6.4
Return           Select
```

```
Timer readings
Read delayed mixing
valve opening    6.5
Return           Select
```

Only in  
operating  
mode B

```
Timer readings
View delayed
OP stop          6.6
Return           Select
```

Only in  
operating  
mode B

To help you when checking the installation, line 6 allows you to read the timer status.

If hot water peak is selected you can see that in status. If it is down at nought the peak is activated at the next need for hotwater.

Shows time remaining before additional heat is activated. If it is not counting downward there is no need for additional heat.

If an alarm is generated an alarm timer is activated. When the alarm has counted down to 0 seconds, additional heat is activated.

Shows the time remaining before the heat pump restarts after previous stop. The heat pump does not start unless there is a need.

Shows time remaining before the mixing valve opens after the boiler has started.

Shows time remaining before the oil-fired boiler stops after a need for its use expires. When the boiler has been taken out of operation completely the additional timer must be restarted.

## Line 8

```
Additional heat
Setting additional
heat timer       8.1
Return           Select
```

Setting the time before additional heat is allowed to start when the heat pump no longer copes with the demand. One hour is the factory setting. If electricity is used as additional heat 1 hour is recommended and 2-3 hours for oil-fired boiler operation.

## Line 12

```
Main menu
Return to
factory settings 12
Return           Select
```

You can always reset to factory settings. If you are at customer levels 1 or 2 when resetting factory settings, only the settings in the displays available at customer levels 1 and 2 are reset. If you are at Installer/Service level, only the displays available for Installer/Service are reset.

# Commissioning the heat pump

## Navigating the menu list

- The example shows you how to navigate menu display 5.13.

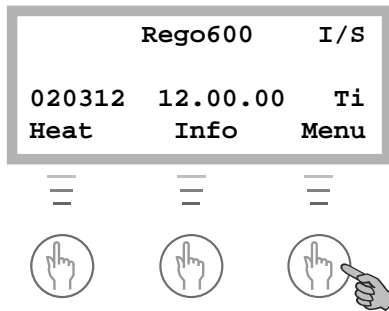

Keep the “Menu” button pressed down for 10 seconds until I/S appears in the top right hand corner. Press “Menu” again...

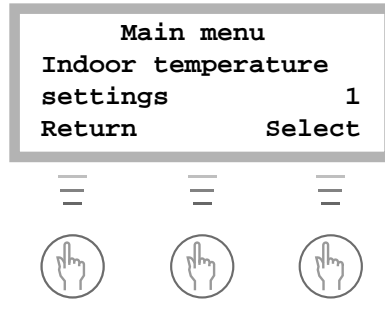

... to arrive at line 1, which is about heating settings. Then turn...

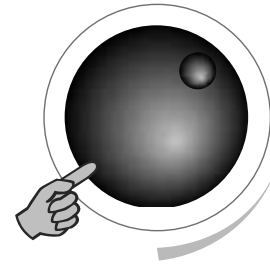

... the knob to the right to go down in the menu to line 5. It should...

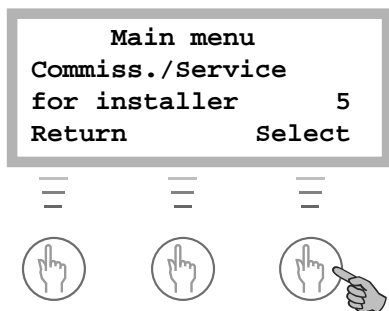

... look like this when you move to line 5. Press “Select” to come into the Commiss/Service menu...

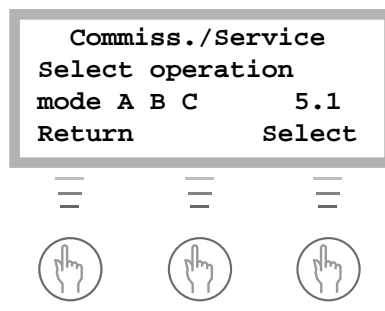

... you then see this display. Now turn the knob to the right until you come down to display 5.13...

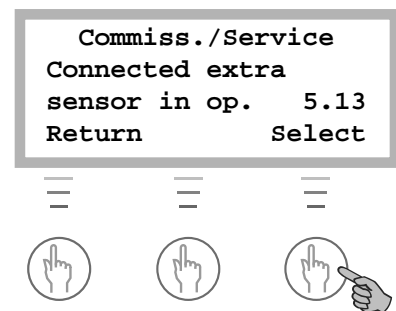

... it should look like this. Press “Select” to enter these menus. You can now...

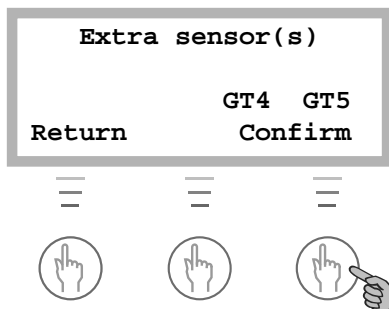

... confirm the extra sensors you have connected by pressing “Confirm”. After a short time...

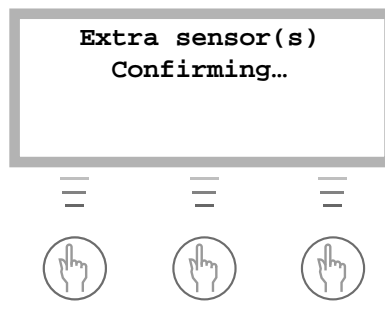

... “Confirming...” appears in the display so you know your settings have been registered. You then see this display...

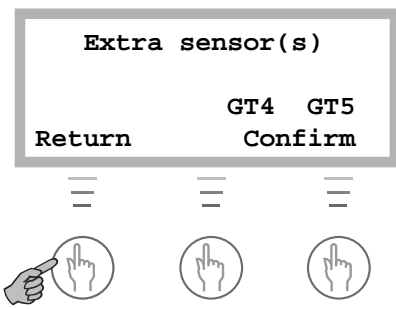

... again. Press “Return” **twice** to return to the main display again.

## General

The heating and heat transfer fluid collector systems must be filled and vented before commissioning the heat pump. Check also that there are no leaks in the systems.

When connecting to an existing water system, check that at least two of the radiators are always open. With underfloor heating, at least two of the circuits must be open. When connecting a fan radiator system, start the fans in the radiators and fully open the valves to the fan radiators.

If the pump stops during testing, refer to the section headed “If something goes wrong”.

## Manual testing

You can manually test pumps, valves etc. by going into display 5.3 and choosing manual operation for each function. The heat pump returns to normal operation as soon as you leave display 5.3.

## Operation with additional heat only

You may want to use the additional heat in the heat pump before with the heat transfer fluid system is ready. If the heating system is filled and vented you can activate the operation with additional heat only. Go into display 5.4 and select Select. Point at Normal Operation, select Adjust. Turn the knob until the arrow points at Only Additional. Press Save. The additional heat will now heat both the hot water and heating system. Do not forget to restore this function to normal operation.

Commiss./Service
Select function
only add. heat 5.4
Return Select

Go into display 5.4 to choose operation with additional heat only. *Note* that this is not available in operating mode B with oil-fired boiler.

# Commissioning operating mode A (C, D and E series)

## Starting the heat pump

Connect the mains voltage to the heat pump and press the ON/OFF button on the control panel.

Rego600 measures the phase sequence so that the compressor does not go the wrong way, so if you receive a phase sequence alarm the main supply is cut to the heat pump and two of the phases are shifted.

Press “Menu” for 10 seconds to come into the Installer / service menu. I/S should be visible at the top right hand corner.

Heating setting Heating incr/decr can temporarily be set at max. So as to avoid waiting for the heat pump restart timer you can go in to display 5.6 and quick start the heat pump. If the pump does not start press Info to see what the reason is. When the heat pump starts, check the sight glass in the heat pump. On starting there may be bubbles in the sight glass for a minute or so, after which they should disappear. Bubbles present all the time the heat pump is running are a fault symptom. They are probably due to air in the collector hose or insufficient heat transfer fluid.

Check that the operational condition of the heat pump corresponds to the information supplied in the Info menu.

Operating mode A is factory setting so most settings are already preset so there are not many you need to check or adjust. **WARNING!** You must never choose another operating mode the A for the C and E series. The *only necessary* settings you have to carry out is Ackning the extra sensors in display 5.13 and choosing the output of the electric heater you have fused the heat pump for.



## Displays you must always check

```

Commiss./Service
Select operation
mode A B C 5.1
Return Select
    
```

Always check that operating mode A is set.

```

Commiss./Service
Connected extra
sensor in op. 5.13
Return Select
    
```

If you have connected any of the external sensors GT3, GT4 or GT5 you must Ackn then so that Rego600 memorises them.

```

Commiss./Service
Select conn capacity
electrical cass. 5.2
Return Select
    
```

Setting maximum output to be used by the electric heater. You can choose 1/3, 2/3 or 3/3. **NOTE!** The heat pump must be fused for the set ouput. Factory setting is 2/3. See description below in technical specifications.

## Displays you might need to adjust or check settings

```

Temperature settings
Heat curve
hysteresis 1.4
Return Select
    
```

Setting of hysteresis on the heat pump's on and off for the return sensor radiator GT1. A low value gives closer intervals between start and stopp.

```

Temperature settings
Mixing valve curve
neutral zone 1.8
Return Select
    
```

Only  
with  
GT4

If you use a second heat curve with a mixing valve you can set the neutral zone for the mixing valve. In the neutral zone nobody can open or shut the signal.

```

Temperature settings
Mixing valve curve
max at GT4 1.9
Return Select
    
```

Only  
with  
GT4

Setting the maximum temperature in the mixing valve circuit. You can set e.g. a max temperature for the floor heating system. Factory setting is 60C.

```

Hot water setting
Setting of hot water
temperature 2.3
Return Select
    
```

Only  
with  
GT3

Setting the temperaturer in the immersion heater's outer shell. Note that the temperature does not correspond to the temperature in the immersion heater itself. Set too high the heat pump can blow on a high return or high pressure.

```

Hot water setting
Setting of
DHW hysteresis 2.4
Return Select
    
```

Only  
with  
GT3

Setting of hysteresis for the hot water temperature. The value measures under and over the set value in 2.3

```

Commiss./Service
Select function
add.heat yes/no 5.5
Return Select
    
```

Factory setting allows the additional heat to enter when required. In systems with only fan-assisted radiators the additional heat can be turned off, in all other cases the settings should be Yes. If you choose No, the additional heat only goes in during alarms, extra hot water and hot water peaks.

```

Additional heat
Show connected elec.
capac. in op. 8.5
Return Select
    
```

This shows you the additional steps in and out in %. See description below in technical specifications.

## Commissioning operating mode B (D series only)

Connect the mains voltage to the heat pump and press the ON/OFF button on the control panel. Rego600 measures the phase sequence so that the compressor does not go the wrong way, so if you receive a phase sequence alarm the main supply is cut to the heat pump and two of the phases are shifted.

Press "Menu" for 10 seconds to come into the Installer / service menu. I/S should be visible at the top right hand corner.

Go into display 5.1 and choose operating mode B. This is described further down in the text.

Heating setting Heating incr/decr can temporarily be set at max. So as to avoid waiting for the heat pump restart timer you can go in to display 5.6 and quick start the heat pump. If the pump does not start press Info to see what the reason is. When the heat pump starts, check the sight glass in the heat pump. On starting there may be bubbles in the sight glass for a minute or so, after which they should disappear. Bubbles present all the time the heat pump is running are a fault symptom. They are probably due to air in the collector hose or insufficient heat transfer fluid.

Check that the operational condition of the heat pump corresponds to the information supplied in the Info menu.

There are always some settings you *have* to check or adjust and some you might need to change if they require another setting than the factory setting.

### Displays you must always check

```
Commiss./Service
Select operation
mode A B C      5.1
Return          Select
```

```
Commiss./Service
Connected extra
sensor in op.   5.13
Return          Select
```

```
Mixed add. heat
Setting of
SV1 runtime    8.3.6
Return          Select
```

Choose operating mode B so that Rego600 memorises the operation with oil-fired boiler and mixing valve.

If you have connected any of the external sensors GT3, GT4 or GT5 you must Ackn then so that Rego600 memorises them.

When you use a mixing valve to the oil-fired boiler it is important to set the running time of the motor. The time it takes for the mixing valve to go from closed to fully open. It is often marked on the mixing valve motor.

## Displays you might need to adjust or check settings

Temperature settings  
Heat curve  
hysteresis 1.4  
Return Select

Hot water setting  
Setting of hot water  
temperature 2.3  
Return Select

Only  
with  
GT3

Hot water setting  
Setting of  
DHW hysteresis 2.4  
Return Select

Only  
with  
GT3

Mixed add. heat  
Time delay for  
mix. valve SV1 8.3.1  
Return Select

Mixed add. heat  
Time delay for  
stop boiler 8.3.2  
Return Select

Mixed add. heat  
Setting of  
ramp time open 8.3.4  
Return Select

Mixed add. heat  
Setting of ramp  
time close 8.3.5  
Return Select

Additional heat  
Show mixing valve  
opening 8.6  
Return Select

Setting of hysteresis on the heat pump's on and off for the return sensor radiator GT1. A low value gives closer intervals between start and stop.

Setting the temperature in the hot water cylinder's outer shell. Note that the temperature does not correspond to the temperature in the hot water cylinder itself. Set too high and the heat pump can shut down on a high return or high pressure.

Setting of hysteresis on the hot water temperature. The value measures under and over the set value in 2.3

Mixing valve's opening is delayed after the boiler starts so that cold water is mixed into the system before the boiler has heated up. You can change the time here.

For safety reasons for the boiler, there is a time delay from the mixing valve not receiving an open signal and the boiler closing down completely. When the boiler closes down completely the additional timer must go down to zero again.

Ramp time open and close is the time the mixing valve shall take to go from closed to fully open and from fully open to closed. In some cases the ramp time can open, 8.3.4 needs to be adjusted to eliminate overexciting the system.

Here you can see if the mixing valve to the oil-fired boiler opens or shuts.

# Commissioning operating mode C (D series only)

Connect the mains voltage to the heat pump and press the ON/OFF button on the control panel. Rego600 measures the phase sequence so that the compressor does not go the wrong way, so if you receive an phase sequence alarm the main supply is cut to the heat pump and two of the phases are shifted.

Press "Menu" for 10 seconds to come into the Installer / service menu. I/S should be visible at the top right hand corner.

Go into display 5.1 and choose operating mode C.

Heating setting Heating incr/decr can temporarily be set at max. To avoid waiting for the heat pump restart timer you can go in to display 5.6 and quick start the heat pump. If the pump does not start, press Info to see what the reason is. When the heat pump starts, check the sight glass in the heat pump. On starting there may be bubbles in the sight glass for a minute or so, after which they should disappear. Bubbles present all the time the heat pump is running are a fault symptom. They are probably due to air in the collector hose or insufficient heat transfer fluid.

Check that the operational condition of the heat pump corresponds to the information supplied in the Info menu.

There are always som settings *youhave* to check or adjust and some you might need to change if they require another setting than the factory setting.

## Displays you must always check

```
Commiss./Service
Select operation
mode A B C      5.1
Return          Select
```

Choose operating mode B so that Rego600 memorises the operation with oil-fired boiler. and mixing valve.

```
Commiss./Service
Select conn capacity
electrical cass. 5.2
Return          Select
```

Setting maximum output to be used by the electric heater. You can choose 1/3, 2/3 or 3/3. **NOTE!** The heat pump must be fused for the set output. Factory setting is 2/3. See description below in technical specifications.

```
Commiss./Service
Connected extra
sensor in op.   5.13
Return          Select
```

If you have connected any of the external sensors GT4, or GT5 you must Ackn then so that Rego600 memorises them.

## Displays you might need to adjust or check settings

```
Temperature settings
Mixing valve curve
neutral zone    1.8
Return          Select
```

Only  
with  
GT4

If you use another heat curve with a mixing valve you can set the neutral zone for the mixing valve. In the neutral zone nobody can open or shut the signal.

```
Temperature settings
Mixing valve curve
max at GT4     1.9
Return          Select
```

Only  
with  
GT4

Setting the maximum temperature in the mixing valve circuit. Factory setting is 60C.

## Important points to check

During the first period after commissioning you should pay special attention to the pressure levels in the heating system and heat transfer circuit. It might need filling up.

The factory setting of the motor cutout is based on a value under the hot water pressure and stable voltage. Because of the various voltages in the electric network the recommended settings are not always suitable and can therefore need adjusting from time to time. This is best achieved using a clip-on ammeter during hot water operation.

For the heat pump to perform at its best, it is important to check the flow on the hot and cold side of the heat pump. Usually, the heat transfer fluid pumps each have a speed selector switch. These must be set correctly for the pressure drop in the systems. A recommended temperature difference over the heat pump on the cold side is between 2-3°C and on the hot side between 7-10°C. The nominal flows specified in *Technical Specifications* give a difference of 3°C to 7°C at operating mode 0/45°C. You can check this with the help of the sensor temperatures in line three of the control panel.

It is also important that the flow in the radiator system exceeds the flow across the heat pump. If this is not the case, the heat pump flow goes back via the bypass to the heat pump return, which may cause the heat pump to trip for high return temperature. The flow through the radiator system must be high enough to ensure that the entire surface of the radiators is kept hot. This maximises the heat-radiating surface and so keeps down the flow temperature from the heat pump.

After testing, vent the system again and top up with cold water if necessary.

## Table of factory settings

The table shows the factory settings of all the settings that can be changed by the installer.

Position	Setting	Factory setting
P1.1	Temp incr/decr	4
P1.2	Temp fine-tune	0°
P1.3	Heat curve adjust	0°
P1.4	Heat curve hysteresis.	5°
P1.5	Mix. valve incr/decr	4
P1.6	Mix. valve fine-tune	0°
P1.7	Mix. valve curve adjusting	0°
P1.8	Mix. valve curve neutral zone	3°
P1.9	Mixing curve max temp.	60°
P1.10	Room temperature	20°
P1.11	Room sensor influence	5
P1.12	Holiday function	0 days
P1.13	Remote control heating	not active
P1.14	Summer disconnection	18°
P1.16	Return thermostat setting	48°
P1.17	Return thermostat hysteresis	5°
P2.1	Additional hot water	0 hours
P2.2	Interval for DHW peak	not active

Position	Setting	Factory setting
P2.3	Setting of DHW temp.	45°
P2.4	Setting of DHW hysteresis	5°
P4.1	Clock setting HP	not active
P4.1.1	Setting level HP	0°
P4.2	Clock sett. add. heat	not active
P4.3	Clock setting DHW	not active
P5.1	Select operating case	A
P5.2	Conn. cap. electric add. heat.	2/3
P5.4	Only add. heat	Off
P5.5	add. heat yes/no 5.5	yes
P5.7	External controls	0
P5.10	Operating option, P2	On
P5.11	Operating option, P3	Off
P8.1	Add. heat timer	60 minutes
P8.3.1	Time delay SV1	30 minutes
P8.3.2	Time delay for stop boiler	60 minutes
P8.3.6	Delay time interval SV1	1 minute

## Technical information

### Table of selected output in display 5.2

The table shows the output available for various selections in display P5.2. If e.g. have chosen 2/3 the output is in two steps. The first step is 3.0kW and the second is 6.0kW.

Model	Max output at 1/3	Max output at 2/3	Max output at 3/3
C4/E5-C11/E11	3.0 kW	6.0kW	9.0 kW

## Technical spec.

Model		C4	C5/D5/E5	C7/D7/E7	C9/D9/E9	D11/E11
Emitted /Supplied output at 0/35°C <sup>1</sup>	kW	4.0/1.0	5.6/1.3	7.7/1.7	8.6/1.9	11.2/2.6
Emitted /Supplied output at 0/50°C <sup>1</sup>	kW	3.3/1.1	4.8/1.5	6.6/2.0	8.2/2.8	10.9/3.8
Nominal flow heating medium	l/s	0.13	0.18	0.26	0.29	0.38
Nominal flow cooling medium	l/s	0.22	0.31	0.46	0.50	0.64
Permitted ext. pressure drop heating medium	kPa	28	24	21	25	25
Permitted ext. pressure drop cooling medium	kPa	32	47	41	45	79
Max pressure radiator system	bar	1,5				
Max pressure cooling medium system	bar	4				
Highest outgoing heating medium temp.	C	55				
Operating temperature heat transfer system	C	-5 to +20				
Integrated heat / HTF pump		Yes				
Electrical connection		400V, N3-phase				
Add. heat reconnectable C/E-model	kW	3.0 / 6.0 / 9.0				
Fuse size D-model	AT	-	10			
Fuse size C/E-model. Depends on electrical additional heat						
Electric water heater 6 kW	AT	16	16	16	20	20
Electric water heater 9 kW	AT	20	20	20	25	25
Electric element 15.75	AT	-	-	-	-	-
Compressor		Piston			Scroll	
Refrigerant R407C	kg	1,0	1,2	1,3	1,4	1,6
Connection, heating medium	Cu/DN	22				
Connection cooling medium	Cu/DN	28				
Dimensions D/E-model (WxDXH)	mm	-	600x450x600			
Weight D/E-model	kg	-	160		180	
Dimensions C-model (WxDXH)	mm	600x600x1770				-
Weight C-model	kg	180/150	220/190			-
Copper/Stainless hw-cylinder						
Integrated double-shelled hw-cylinder on C-models Copper or stainless*		Yes				-
Domestic hot water C-model	litres	165				-
Control unit		Rego 600				

<sup>1</sup> Output data at 0/35°C and 0/50°C are stated in accordance with the European standard EN 255. Additional heat is not included.

\* Anode included with C-models with stainless hw-cylinder.

## Sensor table

The table shows the resistance of all sensors at different temperatures.

Temperature °C	kΩ	Temperature °C	kΩ	Temperature °C	kΩ
-40	154.30	5	11.900	50	1.696
-35	111.70	10	9.330	55	1.405
-30	81.70	15	7.370	60	1.170
-25	60.40	20	5.870	65	0.980
-20	45.10	25	4.700	70	0.824
-15	33.95	30	3.790	75	0.696
-10	25.80	35	3.070	80	0.590
-5	19.77	40	2.510	85	0.503
0	15.28	45	2.055	90	0.430









# Notes

A large rectangular area for writing notes. It features a solid black border at the top and bottom, and a series of horizontal dotted lines for writing. The area is currently blank.

# Notes

A large rectangular box designed for taking notes. It features a solid black border at the top and bottom, and a series of horizontal dotted lines running across the width of the box, creating a ruled area for writing.