

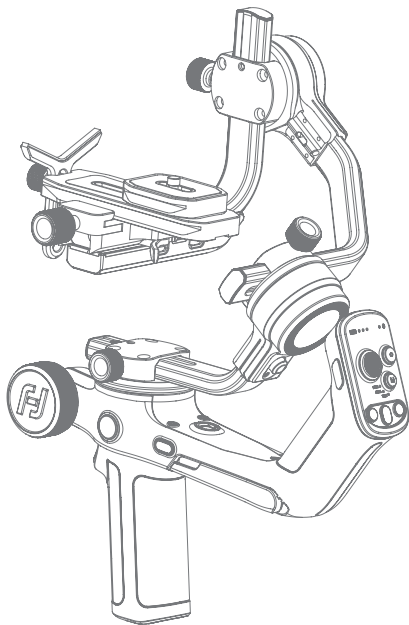

# SCORP-C

Instructions V1.1



Tutorial Videos



# Catalogue

<b>1. Overview</b>	<b>1</b>
<b>2. Getting started</b>	<b>2</b>
2.1 Charging	2
2.2 Adjust the gimbal position to gimbal balancing position	3
2.3 Using support stand	3
<b>3. Mounting the Camera</b>	<b>4</b>
3.1 Attach the quick release plate and camera backing base(Optional)	4
3.2 Install lens holder (Optional)	4
3.3 Mount camera on gimbal	5
<b>4. Gimbal Balancing</b>	<b>6</b>
4.1 Balancing the tilt axis	6
4.2 Balancing the roll axis	7
4.3 Balancing the pan axis	7
4.4 Using the memory slider	8
<b>5. Power ON/ OFF</b>	<b>9</b>
<b>6. Function/Modes introduction</b>	<b>9</b>
6.1 Follow modes introduction	9
6.2 Other function introduction	10
<b>7. App Connecting</b>	<b>11</b>
7.1 Connect with Feiyu SCORP APP	11
7.2 Function introduction of APP	11
<b>8. Operation</b>	<b>14</b>
8.1 Button operation	14
8.2 Indicator	18
8.3 Control ports	18
<b>9. Specifications</b>	<b>19</b>

## Introduction

Feiyu SCORP-C is a professional 3-axis stabilized handheld gimbal for DSLR and mirrorless camera which developed by Guilin Feiyu Technology Incorporated Company. It is compatible with popular DSLR and mirrorless cameras on the market.

Feiyu SCORP-C is designed with button area, multifunction knob and touch screen, which can switch follow modes, control the rotation, image transmission transmitter and the parameters settings by one hand. The camera shutter cable is equipped for controlling the photo taking, video recording and focusing directly at handle.

Feiyu SCORP-C also come with camera control port, image transmission port and 2 extension ports, which support to connect focus motor and other extension device at the same time.

## Tutorial

·The tutorial videos can be watched at FeiyuTech official website or scan the QR code.  
<https://www.feiyu-tech.com/play/>



# 1. Overview

\* Not include camera.

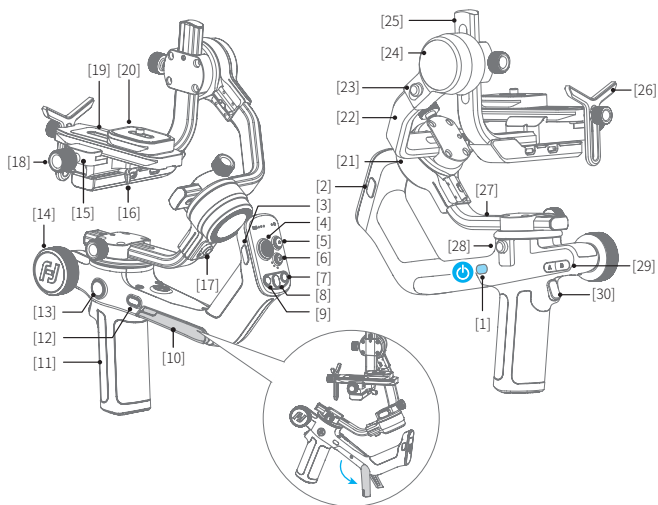

- |                            |                                      |                     |
|----------------------------|--------------------------------------|---------------------|
| [1] Power button           | [13] Knob function switching button  | [25] Slide arm      |
| [2] Motor auto tune button | [14] Multifunction knob              | [26] Lens holder    |
| [3] Portrait button        | [15] Fixed plate slider              | [27] Cross arm      |
| [4] Joystick               | [16] Slider lock                     | [28] Pan lock       |
| [5] Shutter button         | [17] Roll lock                       | [29] A/B button     |
| [6] Mode button            | [18] Quick release plate safety lock | [30] Trigger button |
| [7] R button               | [19] Quick release plate             |                     |
| [8] Auto rotation button   | [20] Arca quick release plate        |                     |
| [9] L button               | [21] Roll axis                       |                     |
| [10] Kickstand             | [22] Cross arm                       |                     |
| [11] Handle                | [23] Tilt lock                       |                     |
| [12] FPV button            | [24] Tilt axis                       |                     |



## Download the App

Scan the QR code to download the app, or search for "**Feiyu SCORP**" in the App Store or Google Play.

\* Requires iOS 9.0 or above, Android 6.0 or above.



iOS



Android

## 2. Getting started

### 2.1 Charging

Please fully charge the battery before power on the gimbal for the first time. Charging with USB 2.0 to Type-C cable, supports quick charge.

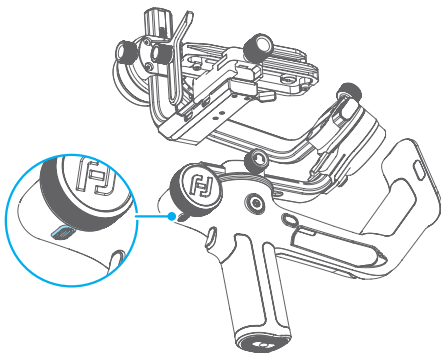

## 2.2 Adjust the gimbal to gimbal balancing position

The gimbal is folded by default, please unlock all the three axes and adjust the gimbal to **gimbal balancing position**, and then lock the three axes.

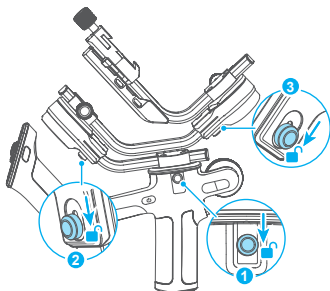

Gimbal folded position

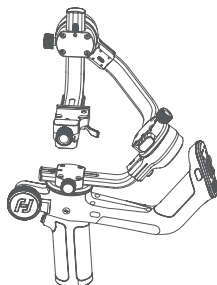

Gimbal balancing position

## 2.3 Using support stand

Users can use the built-in kickstand or install tripod to place the gimbal on a flat surface.

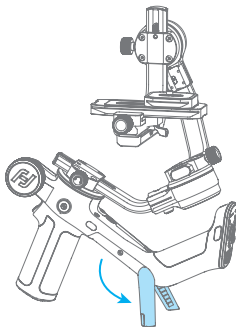

Unfold the built-in kickstand

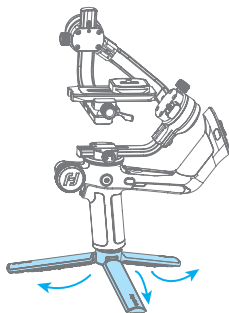

Unfold the tripod

### 3. Mounting the Camera

Before mounting the camera, make sure the camera is ready for shooting (Install the camera lens, and the lens cover should be removed, the memory card and battery needs to be inserted to the camera, and battery is fully charged) , complete all the steps which mentioned in chapter "2. Getting started" and the gimbal is adjusted to **gimbal balancing position**. Make sure the gimbal is powered off or in sleep mode before mounting the camera.

#### 3.1 Attach the quick release plate and camera backing base(Optional)

Attach the quick release plate to camera by tightening the screw.

User can choose to attach the camera backing base if needed ( For example, when using a long or heavy lens). Attach the camera backing base to camera, then attach it to quick release plate by tightening 2 screws.

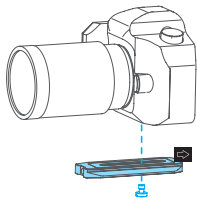

Attach with quick release plate only

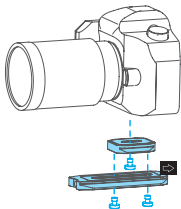

Attach with camera backing base and quick release plate

#### 3.2 Install lens holder (Optional)

Install the lens holder on the quick release plate if needed, the rubber of the lens holder must be directly under the lens. It is recommended to use the lens holder when using a long or heavy lens.

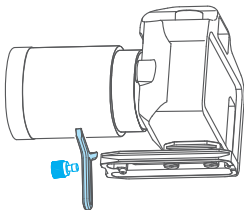

### 3.3 Mount camera on gimbal

Unlock the quick release plate safety lock ①, install the plate with the mounted camera into the slot ② in direction of icon, lock the safety lock ① once the camera is roughly balanced. It is recommended to push the camera against the tilt axis. Unlock the slider lock ③ to move the camera left or right according to camera's width, then lock the slider lock ③.

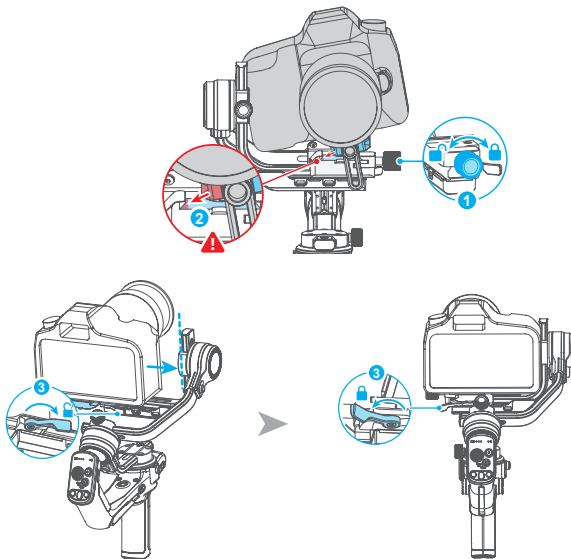

## 4. Gimbal Balancing

Please balance the gimbal before shooting. Make sure the camera and lens are ready for shooting, and the gimbal is powered off or in sleep mode before balancing. **It is recommended to hold up the camera first, then move the slide arm, cross arm and vertical arm.**



Tutorial Videos

### 4.1 Balancing the tilt axis

#### 4.1.1 Balancing the vertical tilt

- Unlock the tilt lock ①, and loosen the slide arm lock knob ②.
- Rotate the tilt axis so that the camera lens is pointing upward. Check the direction which the lens tilts to.
- If the lens tilts to one side, then the camera is that side heavy, move the slide arm ③ to the opposite direction, until the camera is steady pointing upward.
- Tighten the slide arm lock knob ② while holding the camera.

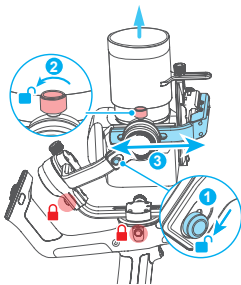

#### 4.1.2 Adjust depth for the tilt axis

- Rotate the tilt axis so that the camera lens is pointing forward. Check the direction which the lens tilts to.
- If the lens tilts to one side, then the camera is that side heavy, unlock the quick release plate safety lock ① and then move the quick release plate to the opposite direction, until the camera is steady pointing forward.

- c. Lock the quick release plate safety lock ① while holding the camera.  
The tilt axis is balanced when the camera is steady while tilted up or down by 45° .

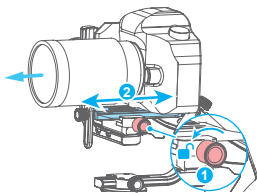

## 4.2 Balancing the roll axis

- a. Unlock the roll lock ① , check the direction which the camera tilts to.  
b. If the camera tilts to one side, then the camera is that side heavy, loosen the cross arm lock knob ② and then move the cross arm to the opposite direction, until the camera can stay still and horizontal to the ground.  
c. Tighten the cross arm lock knob ② .

The roll axis is balanced when the camera can stay still and horizontal to the ground.

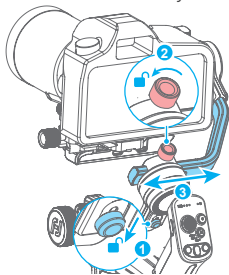

## 4.3 Balancing the pan axis

- a. Unlock the pan lock ① . Hold the tripod, and tilt the gimbal forward until it is horizontal to the ground.  
b. If the camera tilts to one side, then the camera is that side heavy, loosen the vertical arm lock knob ② and then move the vertical arm ③ to the opposite

direction, until the camera can stay still and horizontal to the ground.

c. Tighten the vertical arm lock knob ② .

The pan axis is balanced when the camera can stay still and horizontal to the ground.

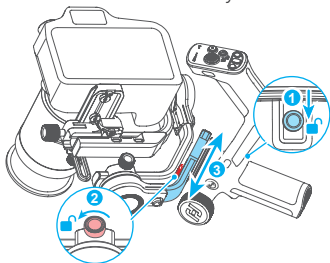

#### 4.4 Using the memory slider

Feiyu SCORP-C come with the memory slider which can make balancing easier. After balancing the gimbal, move the memory slider to the hole in axis, and make the red dot on the memory slider exposing from the hole, in order to mark the current position.

Next time, If the objects which users mount on are the same, users can just move the axis to the position which can make the red dot exposing from the hole to make the gimbal balanced.

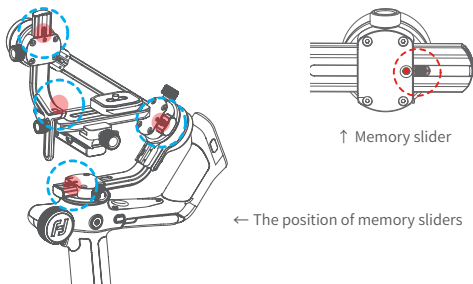

## 5. Power ON/ OFF



(1) Before power on the gimbal, make sure you have balanced gimbal, and unlocked all the three axes.

(2) If you haven't unlocked all the 3 axes, gimbal will enter sleep mode to protect itself. Please single tap power button to wake up gimbal after unlocked all the 3 axes.

**! Please set motor power first after powering on gimbal for the first time or after changing a new camera/lens.**

Long press the power button and release it when you hear the beep sound to power on/ off.

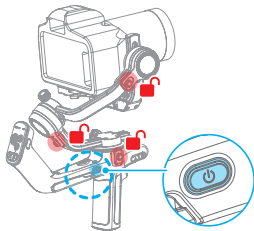

## 6. Function/Modes introduction

### 6.1 Follow modes introduction

① **PF** (Default mode)

Pan follow, only the pan axis follows the movement of user's hand.

② **PTF**

Pan and tilt follow, where both the pan and tilt axes follow the movement of user's hand, but roll axis does not.

③ **FPV**

Pan, tilt and roll follow, where all 3 axes follow the movement of user's hand.

④ **Lock**

All 3 axes do not follow the movement of user's hand, gimbal keeps the direction of the camera fixed.



## 5 FFW

Flash follow, where all 3 axes follow the movement of user's hand in high follow speed.

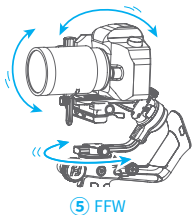
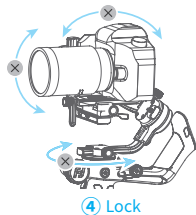
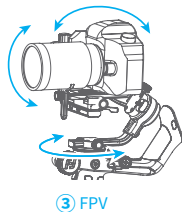
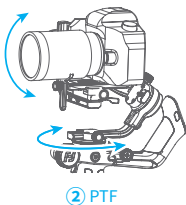
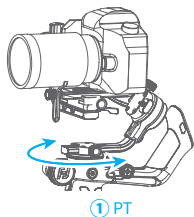

## 6.2 Other function introduction

### Auto rotation

Camera will auto rotate to shoot according to the rotation speed and direction that set by users. It can be used to achieve the image rotating scene which been used frequently in movie Inception.

### Portrait mode

Enter portrait mode for recording portrait video or live streaming.

### Selfie mode

The camera turns 180° horizontally, selfie shooting is available.

### Track video

Record track video according to the waypoints which has been set (via Feiyu SCORP App) .

## Manual lock

Manually move camera to desired position, and hold for half a second. New tilt /pan positions are automatically saved.

# 7. App Connecting

## 7.1 Connect with Feiyu SCORP APP

(1) Turn on the gimbal  
(2) Turn on the smartphone Bluetooth, run Feiyu SCORP APP, tap the top of the home page to connect gimbal.  
After the connection succeeds, it's easy to control gimbal via APP, including control the pan and tilt axis angle with the virtual joystick, switch modes, set motor power/camera parameters/follow speed, set other functions, parameters, and update firmware.

## 7.2 Function introduction of APP

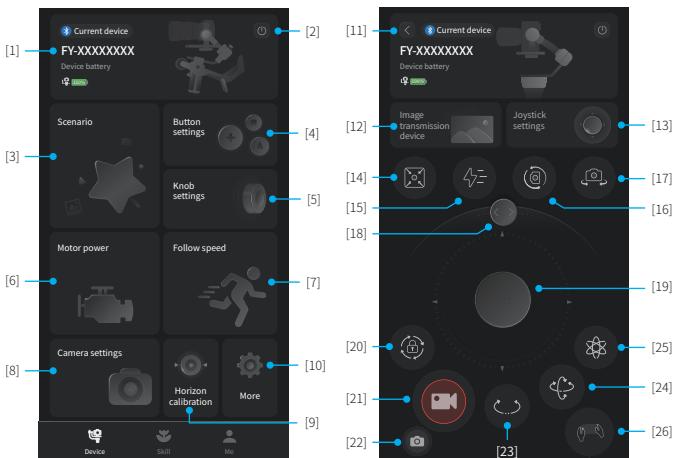

### [1] Gimbal control access

Display the product name and device battery of current connecting gimbal, tap to enter gimbal operation interface, which allows user to use virtual joystick to control gimbal, switch follow modes, recenter gimbal, adjust horizontal angle manually. When not connected to gimbal, prompt user to connect with gimbal.

### [2] Disconnect device

Tap to disconnect current connecting device.

### [3] Scenarios

Provide auto rotation (can be used to achieve the image rotating scene which been used frequently in movie Inception), panorama, timelapse (Motionlapse/Static timelapse/Hyperlapse), track video and other usage scenarios for user.

### [4] Button settings

Set the function when press and hold the trigger button.  
Set auto focus time, attitude change time for A/B button.

### [5] Knob settings

Set the control object for multifunction knob, can be set as control axes, control electronic focus, control focus motor.  
Set damp, speed, smooth, sound and indicator light for two knobs in "More".

### [6] Motor power settings

Adjust tilt, roll, pan axes motor power manually or use auto tune function to tune the motor power automatically (Recommended).



Please set motor power first after power on gimbal for the first time or after change a new camera/lens.

### [7] Follow speed

Select different preset gimbal follow speed profiles: Slow/Med/Fast, or custom follow speed and dead zone.

### [8] Camera settings

Can set camera aperture, shutter speed and ISO parameters after connecting with camera.

### **[9] Horizon calibration**

Calibrate the gimbal with the auto calibration function(Recommended) or adjust it manually (When not in FPV or FFW mode).

### **[10] More**

Set boot silent, disable selfie, manual lock, check firmware information and update firmware, restore the default settings.

### **[11] Back**

Tap to return to home page.

### **[12] Connect with image transmission device**

Tap to connect image transmission device.

### **[13] Joystick settings**

Can set the joystick speed for controlling pan/tilt axis, and joystick as pan axis/tilt axis inverted.

### **[14] Recenter**

Tap to recenter the gimbal.

### **[15] Flash follow(FFW)**

Tap to enter Flash follow.

### **[16] Portrait mode**

Tap to enter portrait mode.

### **[17] Selfie mode**

Tap to enter selfie mode.

### **[18] Adjust horizontal angle**

Slide the slider to control roll axis to adjust the current horizontal angle.

### **[19] Virtual joystick**

Use virtual joystick to control pan and tilt axis.

## [20] Lock mode

Tap to enter lock mode.

## [21] Shutter

Tap to start/stop recording or take photo.

## [22] Switch between photo/video mode

Tap to switch between switch between photo/video mode

## [23] Pan follow (PF)

Tap to enter pan follow (PF) mode.

## [24] Pan and tilt follow (PTF)

Tap to enter pan and tilt follow (PTF) mode.

## [25] FPV

Tap to enter FPV mode.

## [26] Motion sensing mode

Tap to enter motion sensing mode which can control the pan and tilt axis to follow the movement of smartphone, can not switch follow modes in motion sensing mode (PF/PTF/FPV/Lock).

# 8. Operation

## 8.1 Button operation

### 8.1.1 Power button

**Long press:** Power on/off

**Single tap:** Wake up

**Double tap:** Enter sleep mode

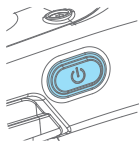

### 8.1.2 Mode button

**Single tap:** Switch among Lock/PF/PTF/ FPV/ FFW mode (Switch in turn)

**Tap five times:** Horizon calibration(Single tap to wake up after calibration completed)



### 8.1.3 Trigger button

**Double tap:** Recenter

**Triple tap:** Enter/Exit selfie mode (Pan axis turn 180°)

**Press and hold:** PTF (Release to exit)

You can custom the function via APP

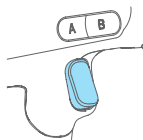

### 8.1.4 Joystick

**Push:** Control the movement of the tilt and pan axes.



### 8.1.5 Shutter button\*

**Press half way:** Focus

**Single tap (Fully):** Start/stop recording

**Long press (Fully):** Take photo



### 8.1.6 Auto rotation button

**Single tap:** Enter auto rotation mode

**Single tap again:**

(1) Exit auto rotation mode (When gimbal is not rotating)

(2) Pause the rotation (When gimbal is rotating)



### 8.1.7 L button

**Single tap:** Turn left continuously

**Single tap again:** Switch rotating speed (Switch cyclically among Slow/Med/Fast orderly, the preset speed is Med)

Active in auto rotation mode



### 8.1.8 R button

**Single tap:** Turn right continuously

**Single tap again:** Switch rotating speed (Switch cyclically among Slow/Med/Fast orderly, the preset speed is Med)

Active in auto rotation mode



### 8.1.9 Portrait button

**Double tap:** Enter/Exit portrait mode



### 8.1.10 Motor auto tune button

**Long press for 5s:** Enter motor power auto tune process

Gimbal start auto tune motor power after a long beep, and the long beep sound ring again after auto tune completed.



### 8.1.11 button

**Single tap:** Enter/Exit FPV mode



### 8.1.12 A/B button

**Long press:** Mark the current position as A/B

**Single tap:** Return to the position A/B that you have marked

Can be used to mark axes/focus position.

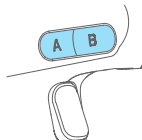

### 8.1.13 Knob function switching button

**Single tap:** Switch the control object while controlling the movement of the 3 axes (Tilt/Pan/Roll)

**Long press:** Switch the control options of Multifunction knob in turn (The movement of the 3 axes/Electronic focus/Focus motor)



### 8.1.14 Multifunction knob

**Turn:**

- (1) Control the movement of the roll, tilt and pan axes.
- (2) Control focus.
- (3) Control focus motor.

Set current control option as option (1) or (2) or (3) through long press the knob function switching button or swipe up in home page.

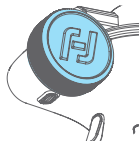

\*Need to connect with camera. Refer to the camera compatibility list on: <https://www.feiyu-tech.cn/feiyu-scorp-c/>

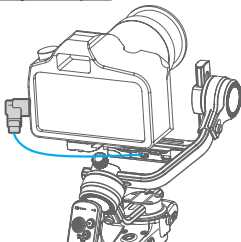

Connect camera with shutter cable



## 8.2 Indicator

[1] Battery indicator A/  
B/C

[2] Camera/Bluetooth  
indicator

[3] Follow status  
indicator

TILT = Tilt axis  
ROLL = Roll axis  
PAN = Pan axis

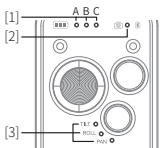

The indicator is on which means the corresponding axis follows the movement of user's hand.

### Camera/Bluetooth indicator instruction

Camera connection	Bluetooth connection	Indicator
✓	✓	●●■■■■ ●●■■■■
✓	X	●●■■■■ ○●■■■■
X	✓	●
X	X	○

### Follow status indicator instruction

Mode	Follow status indicator		
	TILT	ROLL	PAN
Lock	○	○	○
PF	○	○	●
PTF	●	○	●
FPV	●	●	●
FFW	●●●	●●●	●●●
Auto rotation	●	●	●

### Battery indicator instruction

Battery level	Battery indicator		
	A	B	C
100%	●	●	●
80%	●	●	●
60%	●	●	○
40%	●	●	○
20%	●	○	○
10%	●	○	○
Low power, will auto power off	●	○	○

Icon:

- / ● / ● / ● Light of corresponding color is on
- Light is off
- Blue light flashes quickly
- Blue light keeps flashing twice
- Blue light flashes twice then grows solid blue for 1.5s, keeps repeating

## 8.3 Control ports

There is a camera control port, an image transmission port, and 2 extension ports on the fixed plate, to connect focus motor and other extension devices.

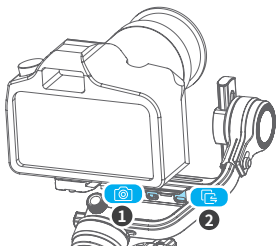

- ① Camera control port
- ② Image transmission port

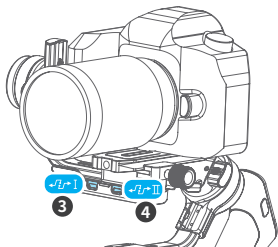

- ③ Extension port 1/Focus motor port 1
- ④ Extension port 2/Focus motor port 2

## 9. Specifications

Product name	Feiyu SCORP 3-Axis Camera Handheld Stabilizer
Product model	Feiyu F2
Max. Tilt Range	+120° ~ -201°
Max. Roll Range	+215° ~ -106°
Max. Pan Range	360°
Weight	About 1200g
Payload Capability	About 2500g (Well-balanced)
Battery life	13 Hours
Battery	2500mAh
Operating Voltage	6.8V-8.4V
Compatible Cameras	Sony, Canon, Nikon, Panasonic camera etc. ( Please download the detailed manual for the specific compatible camera and lens )

## Accessories



USB 2.0 to Type-C  
×1



Type-C to Micro(A03)  
×1



Type-C to Type-C (C02)  
×1



Type-C to TRS2.5 (T02)  
×1



Type-C to Multi  
Sony shutter cable  
×1



Type-C to 2.5mm Panasonic  
shutter cable (DC2.5mm)  
×1



Tripod  
×1



Quick release plate  
×1



Camera backing base  
×1



Lens holder  
×1



Lens holder screw  
×1



Camera fixed screw  
×3

## **Notice**

1. Make sure motor spinning is not blocked by external force when the product is power on.
2. The product DO NOT contact water or other liquid if the product is not mark waterproof or splash-proof. Waterproof and splash-proof product DO NOT contact sea water or other corrosive liquid.
3. DO NOT disassembly the product except marked detachable. It need send to FeiyuTech after-sales or authorized service center to fix it if you accidently disassembly and cause abnormal work. The relevant costs are borne by user.
4. Prolonged continuous operation may cause the product surface temperature to rise, please operate carefully.
5. DO NOT drop or strike the product. If the product is abnormal, contact Feiyu After-sales support.

## **Storage and Maintenance**

1. Keep the product out of the reach of children and pets.
2. DO NOT leave the product near heat sources such as a furnace or heater. DO NOT leave the product inside of a vehicle on hot days.
3. Please storage the product in dry environment.
4. DO NOT overcharge or overuse the battery, otherwise it will cause damage to the battery core. If does not use the product for a long time, please charge it at least once within one month.
5. Never use the product when the temperature is too high or too low.

## FCC regulatory conformance:

This device complies with Part 15 of the FCC Rules. Operation is subject to the following two conditions:

- (1) This device may not cause harmful interference.
- (2) This device must accept any interference received, including interference that may cause undesired operation.

### **NOTE**

This equipment has been tested and found to comply with the limits for a Class B digital device, pursuant to part 15 of the FCC Rules. These limits are designed to provide reasonable protection against harmful interference in a residential installation.

This equipment generates uses and can radiate radio frequency energy and, if not installed and used in accordance with the instructions, may cause harmful interference to radio communications. However, there is no guarantee that interference will not occur in a particular installation. If this equipment does cause harmful interference to radio or television reception, which can be determined by turning the equipment off and on, the user is encouraged to try to correct the interference by one or more of the following measures:

- Reorient or relocate the receiving antenna.
- Increase the separation between the equipment and receiver.
- Connect the equipment into an outlet on a circuit different from that to which the receiver is connected.
- Consult the dealer or an experienced radio/TV technician for help.

### **NOTE**

The manufacturer is not responsible for any radio or TV interference caused by unauthorized modifications to this equipment. Such modifications could void the user's authority to operate the equipment.

### **RF Exposure**

This equipment complies with FCC radiation exposure limits set forth for an uncontrolled environment.



Website



Facebook



Youtube



Twitter



Instagram

This document is subject to change without notice. If you have any questions about this document, please contact us by the following ways.

Manufactured by: Guilin Feiyu Technology Incorporated Company  
Website: [www.feiyu-tech.com](http://www.feiyu-tech.com)  
E-mail: [support@feiyu-tech.com](mailto:support@feiyu-tech.com)  
Tel: +86 773-2320865

