

AK4500

3-Axis Stabilized Handheld Gimbal for Camera

Quick Start Guide

EN V1.2

AK4500 Overview

The AK4500 is divided into a standard kit and an essentials kit. The standard kit comes with extension rod, AK series brushless follow focus, and hyperlink remote controller. You can choose the most suitable one for your needs.

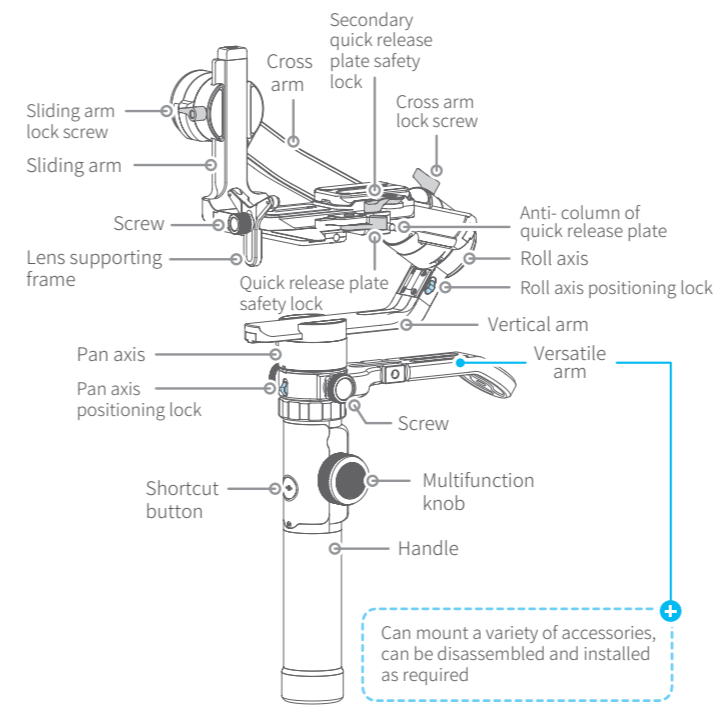
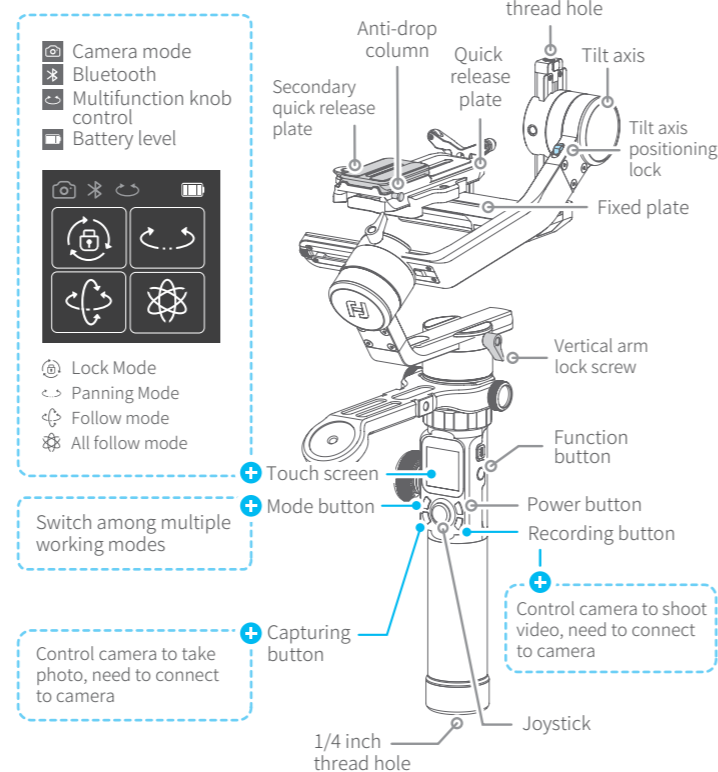

Can mount a variety of accessories, can be disassembled and installed as required



* This product does not include the camera.
* Scan QR codes to download detailed manual for more usage of the gimbal.

User Guide

⚠ Read the detailed manual before using it.

TIPS

- (1) Please install the camera before powering on the gimbal.
- (2) When the battery is low, please charge the gimbal.
- (3) When not in use, turn off the gimbal and then remove the batteries.
- (4) Follow the steps to quickly experience the basic features of the AK4500.

1 Battery Installation

Remove the tail cap, open the batteries compartment, and install the batteries correctly.



⚠ Please fully charge the batteries before powering on the gimbal for the first time.

2 Handle Installation

Align the handle positioning screw with the corresponding positioning holes under the pan axis machine and then tighten the fixing ring.

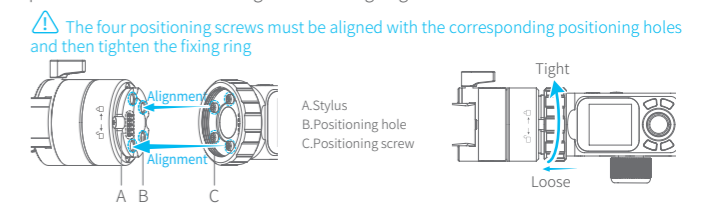

3 Positioning Lock

Each of the three rotating axis has one positioning lock for convenient positioning and storage purposes. Be sure to unlock them before using the gimbal.

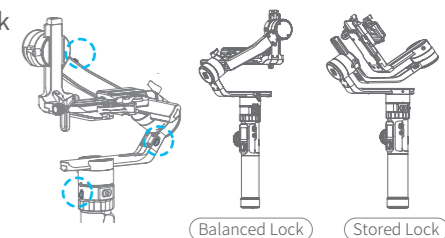

For More



More Downloads



Operation Tutorial

Specifications

Max. Tilting Range	230°
Max. Rolling Range	360°
Max. Panning Range	360°
Tilting Speed	2°/s ~ 75°/s
Panning Speed	3°/s ~ 150°/s
Operation Time	12 Hours
Weight	About 1656g (Not including the batteries)
Payload	4600g (In center of gravity balanced state)
Adapter Camera	Some of the camera like Canon, SONY, Panasonic and etc. (Please download the detailed manual for the specific compatible camera and lens)



Guilin Feiyu Technology Incorporated Company

For more information, please visit our official website www.feiyu-tech.com

E-mail: service@feiyu-tech.com Tel: +86 (0) 773 2320865

Due to software and hardware improvements, your actual product might differ from the descriptions and pictures in this user manual. You can get the latest user manual from the official website.

4 Camera Installation

⚠ Make sure the battery and memory card are loaded before installation.

- (1) Install the quick release plate to the fixed plate and take out the secondary quick release plate.
- (2) Fix the secondary quick release plate to the bottom of the camera.
- (3) Insert the secondary quick release plate tilted and press down. The secondary quick release plate safety lock automatically locks and locks the secondary quick release plate safety lock.
- (4) Install the lens support frame to ensure that the lens holder can hold the lens firmly.

5 Gimbal Balancing

⚠ Before balancing the gimbal, lock the gimbal to the balance lock state at first, unlock each axis positioning lock in stages during the balancing process.

- (1) Before balancing the gimbal, the lens cover should be removed from the camera and the memory card needs to be inserted to the camera to complete all the connections to ensure that the camera is ready for shooting.
- (2) During balancing the gimbal, make sure the camera is powered off and the gimbal is turned off.
- (3) If add accessories after the balancing is completed, need to re-balance.

TIPS

5.1 Balance Adjustment of the Tilting Axis

- (1) a. Unlock the tilt axis positioning lock ①, place the camera lens vertically upwards, determine the camera's center of gravity.
- b. Loosen the sliding arm lock screw ②, slide the sliding arm ③ to balance the camera position.
- c. Tighten the sliding arm lock screw ②, if the camera lens can stay vertically upwards that means balanced.

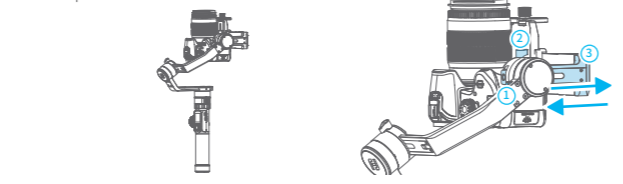

- (2) a. Place the camera lens vertically upwards, determine the camera's center of gravity.
- b. Unlock the quick release plate safety lock ①, balance the camera position.
- c. Tighten the quick release plate safety lock ① and tilt the camera up or down, if it stays stable, it means balanced.

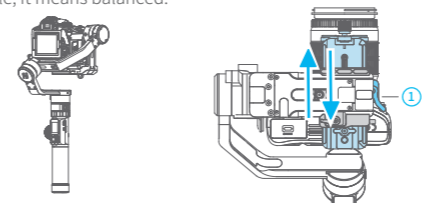

5.2 Balance Adjustment of the Rolling Axis

- a. Tighten the tilt axis positioning lock ①, release the roll axis positioning lock ②, and observe the camera tilt state.
- b. Loosen the cross arm lock screw ③, slide the cross arm ④ to balance the camera position.
- c. Tighten the cross arm lock screw ③ and tilt the camera to the left or right, if it stays stable, it means balanced.

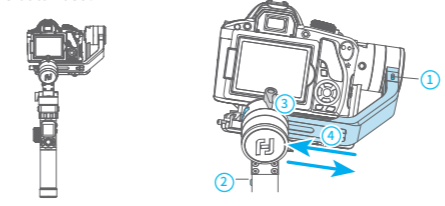

5.3 Balance Adjustment of the Panning Axis

- a. Tighten the pan axis positioning lock ①, loosen the pan axis positioning lock ②, keep the handle part of the gimbal parallel to the ground and the vertical arm parallel to the ground, and observe the camera rotation after the releasing.
- b. Loosen the vertical arm lock screw ③, slide the vertical arm ④ to balance the camera position.
- c. Tighten the vertical arm lock screw ③ to rotate the pan axis to any angle, if it stays stable, it means balanced.

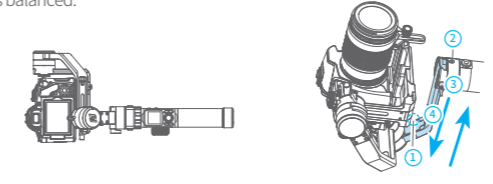

6 Power on / off

⚠ Before powering on the gimbal, need to unlock all the axis positioning lock.

Long time press the power button, release it when the display show **FJ**



7 Download the Feiyu ON App

Scan QR codes to download and install Feiyu ON App.

* Requires iOS 9.0 or later, Android 6.0 or later.



iOS Version



Android Version

8 Connecting App

- (1) Turn on the mobile phone Bluetooth and start the gimbal.
- (2) Open the App, and connect to AK4500 according to the App prompts. After the connection is successful, you can control AK4500 on the App.

DISCLAIMER

Prohibit any user for any illegal purpose. Users will be responsible for all behaviors of purchase and use of products. The Company assumes no liability for any risks related to or resulting from the debug and use of this product (including the direct, indirect or third-party losses). For any unknown sources of using, we will not be at any services. The updating and changes of product firmware and programme may cause changes in function descriptions in this user manual, please read the instructions carefully before upgrading the firmware and use the corresponding user manual. You can get the latest user manual from the official website: www.feiyu-tech.com FeiyuTech reserves the right to amend this manual and the terms and conditions of use the gimbal at any time.