

Instructions for the use and care of the accessories

MELAtherm® 10

from software version 1.311

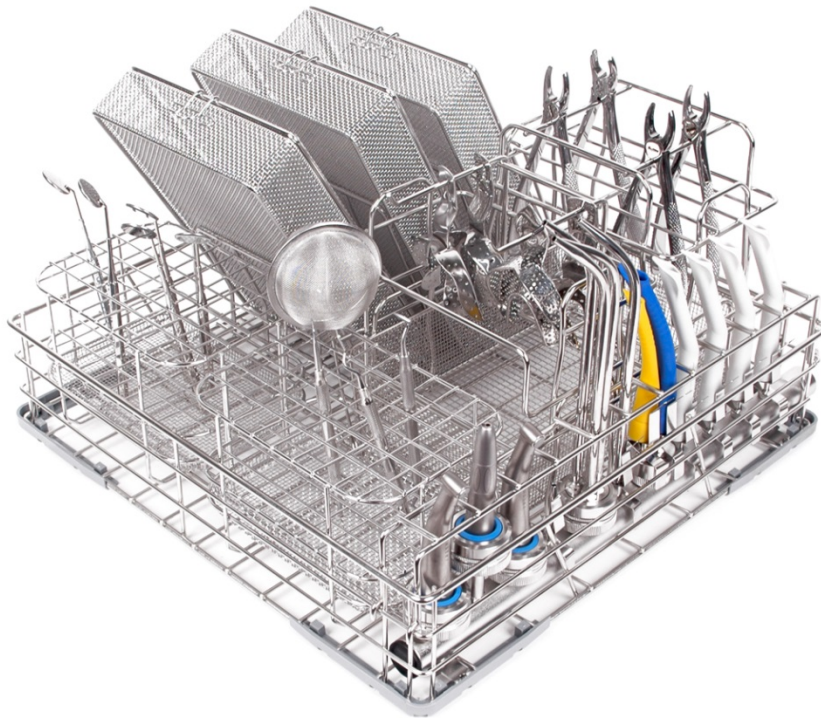

Dear doctor,

We thank you for your confidence demonstrated by the purchase of this MELAG product.

As an owner-run and operated family concern founded in 1951, we have a long history of successful specialization in hygiene products for practice-based use. Our focus on innovation, quality and the highest standards of operational reliability has established MELAG as the world's leading manufacturer in the instrument treatment and hygiene field.

You, our customer are justified in your demand for the best products, quality and reliability. Providing "**competence in hygiene**" and "**Quality – made in Germany**", we guarantee that these demands will be met. Our certified quality management system is subject to close monitoring: one instrument to this end is our annual multi-day audit conducted in accordance with ISO 13485. This guarantees that all MELAG products are manufactured and tested in accordance with strict quality criteria.

The MELAG management and team.

General guidelines

Please read these accessories usage advice very carefully before using the accessories in the MELAtherm 10. They include important safety information.

Please store this document carefully and in close proximity to the washer-disinfector. They represent a component of the product.



Validity

The information contained in this document applies to the accessories which it describes and which are designed exclusively for use in conjunction with the MELAtherm 10 washer-disinfector.

The most up-to-date accessories usage advice is found on the MELAG download center under www.melag.com.

About this document

Symbols used

Symbol	Explanation
	Indicates a dangerous situation, which if not avoided, could entail slight to life-threatening injuries.
	Draws your attention to a situation, which if not avoided, could result in damage to the instruments, the practice fittings or the device.
	Draws your attention to important information.

Formatting rules

Accentuation	Explanation
see ...	Reference to another text section within this document

Contents

Optimizing the cleaning performance and value-retention of the instruments.....	7
Principles of the load configuration	9
The 6 segment principle	9
The Flex System.....	10
Accessories for exterior cleaning	11
Basis baskets	11
Basis basket without injector rail	11
Basis basket with injector rail (incl. 11 blind screws).....	11
Basis basket with injector rail (incl. 11 nozzles and clamp springs).....	12
Basis basket with injector rail (inc. Cleanfinity filter / plastic central filter)	12
Insert racks	18
Insert rack for 3 MELAstore-Trays/ sieve cassettes	18
Insert rack for 4 MELAstore-Trays/sieve cassettes	18
Insert rack for MELAstore-Tray 50 (12 pcs.)/MELAstore-Tray 100 (6 pcs.)	19
Insert rack for 5 trays / 10 half-trays.....	20
Instruments and washing baskets	21
Instrument basket compact	21
Instrument basket standard.....	21
Instrument basket >G<.....	21
Needle tip plate for instrument basket.....	22
Small parts container	23
Stackable insert racks and baskets (flex system)	24
Flex basket 1.....	24
Flex basket 2.....	24
Flex basket 3.....	24
Flex basket 6.....	25
Injector basket Flex 1.....	26
Insert rack for impression trays, scissors and clamps	28
Insert rack for hinged instruments.....	29
Flex basket specula	30
Attachments for stackable baskets (Flex system).....	31
Ear speculum attachment Flex 1.....	31
Ear speculum attachment Flex 2.....	32
Ear speculum attachment Flex 3.....	33
Attachment for flex basket with brackets.....	34
Bracket for Flex attachment	35
Instrument holder for flex baskets (60 pcs.)	36
Sieve cassettes and inserts	37
Sieve cassette.....	37
Dividing insert for sieve cassette.....	38
Protrusion guard for the sieve cassette.....	38
Protective insert for the sieve cassette.....	39
MELAstore-Tray 50	40
MELAstore-Tray 100	40
MELAstore-Tray 200	40
Accessories for interior cleaning	42
Connectors and adapters for instruments.....	42
Injector nozzle	42
Clamp spring for injector nozzle	43
Irrigation sleeve for instruments with Ø 2-11 mm	43
Adapter (male) for Luer-Lock	46
Adapter (female) for Luer/Luer-Lock	46
Adapters for tips	47
Adapter for tips M3.0 x 0.5 mm, external thread	47
Adapter for tips M3.6xPH1.5 P0.5, internal thread	47
Adapter for tips M3.0 x 0.35 mm, external thread	47
Marking discs for adapters for tips	48
Adapters for transfer instruments.....	50
Selection aid for the use of adapters for transfer instrument	50
Adapters for ISO connector (INTRA coupling)	51
Adapter for KaVo turbines (MULTIflex connection)	51
Adapter for Sirona Classic.....	52
W&H turbine adapter.....	54
Filter disc housing with ceramic filter disc	54
Universal adapter (incl. 3 inserts and ceramic filter disc)	56
Distance sleeve.....	58
Adapter for exterior spray channels	59
Double distributor.....	60
Triple distributor (incl. ceramic filter disc)	61
Filter inserts	63
Ceramic filter disc (10 pcs.).....	63
Metal filter disc	64
Plastic central filterl	65
Cleanfinity filter (inc. cleaning brush)	66
Sealing elements	68
Silicone sealing cap, green (10 pcs.)	68
Silicone sealing cap, blue (10 pcs.).....	69
White silicone sealing cap (10 pcs.).....	69
Sealing screw for injector rail and distributor.....	70
Seal (male) for Luer-Lock.....	70
Seal (female) for Luer/Luer-Lock.....	71
Hoses and hose connections.....	72

Connection for hoses with interior Ø 6 mm, external thread.....	72
Connection for hoses with interior Ø 6mm, internal thread.....	73
Silicon hose Ø 10/6 mm, running metre.....	73
Hose extension with screw connections.....	74
Examples for basic configurations.....	75
Basic configuration for the ENT practice.....	75
Basic configuration for the gynaecological practice	75
Basic configuration for the dental practice.....	76
Basic configuration for the OMF surgery	76

Safety instructions

When using the MELAtherm 10 accessories, please ensure that you observe the following safety instructions as well as those outlined in the following chapters.

Instruments/accessories

- For your own safety and to avoid injuries when loading the instrument and washing baskets, always wear gloves or other suitable hand protection.
- Please note that instruments, instrument and washing baskets and other accessories can still be hot after the decontamination process.
- Use only those instruments designed by their manufacturer for automatic treatment in a washer-disinfector. Please ensure that you observe the information provided by the instrument manufacturers ISO 17664. It is especially important to observe the manufacturer's information when treating newly purchased instruments for the first time.
- Use original accessories from MELAG. We cannot provide a guarantee for non-MELAG accessories, even if they are in possession of validation.
- When using additional accessories from other manufacturers to secure instruments, especially hollow-bodied instruments, it is necessary to observe the information contained in the manufacturer's operating manual.
- If using accessories from other manufacturers, above all hoses, please ensure that they are heat-resistant up to 95 °C. This applies above all to hoses.
- Use only those process agents approved by MELAG. Observe the operating and safety information from the process agent manufacturer. MELAG does not accept any liability for the use of any process agents not approved by MELAG.
- Take care when arranging sharp and pointed instruments and do so in a manner that prevents all danger of injury. Loading should best be performed from back to front. Wear suitable protective gloves.
- Comply with pre-determined loading patterns established within the scope of the validation procedure.

Load

- Ensure the correct arrangement of the instruments. Avoid spray shadow and repeated stacking of the instruments.

Storage

- Store all accessories in a dry atmosphere protected from corrosive objects or media.

Disposal

- Accessory parts which display strong signs of wear e.g abrasion, cracks or corrosion must be disposed of correctly.

General instructions for preparation and treatment

1 Hollow-bodied instruments

- 1.1 The automatic decontamination of hollow-bodied instruments requires that they be arranged in the washer-disinfector on adapters on the injector rail or via suitable load elements to ensure sufficient throughflow. Universal dental aspirator tips with 11 mm and 16 mm connections can be treated in instrument baskets in a standing position. The distal end must point upwards. This must be considered separately during validation.
- 1.2 After decontamination, complex hollow bodies such as transfer instruments must be dried using medical compressed air to remove residual moisture. Comply with all relevant national specifications.
- 1.3 Before and after decontamination, check the instruments for a secure position on the adapters, the hose connections or the injector nozzles. The instruments must not be able to become detached during the program run. If this happens, they require further decontamination in the washer-disinfector.
- 1.4 When using the basis basket in conjunction with an injector rail, please ensure that you always push the basis basket against the rear wall of the chamber to the fullest extent, so that the injector rail locks on to the connection fitting on the inner wall of the washing chamber.
- 1.5 Observe the treatment instructions provided in the user manual of the washer-disinfector regarding transfer instruments and ophthalmological instruments.
- 1.6 The operator is responsible for validating the procedure in combination with special load accessories. Especial attention is to be accorded to the feed line to the hollow-bodied instruments.
- 1.7 Treat only those hollow-bodied instruments which guarantee sufficient and reproducible rinsing. Before treatment, check the hollow-bodied instruments for passage by rinsing them with water of a minimum quality equal to drinking water.

2 Injector rails and distributor

- 2.1 Sufficiently high rinse pressure is important for the cleaning. Always place instruments on the adapter. If possible, seal non-used adapters with the suitable silicone sealing cap. Seal the unused connections on the injector rail with sealing screws (art. no. 80140).

3 Adapters for transfer instruments

- 3.1 Please note that leading manufacturers of transfer instruments recommend drying the spray/air/water channels immediately after treatment using medical compressed air. In doing so, it is necessary to maintain the patency of the channels.
- 3.2 This must then be followed by maintenance using maintenance and care products/oils approved by the instrument manufacturer.

Optimizing the cleaning performance and value-retention of the instruments

The following important treatment instructions ensure that your washer-disinfector achieves the best possible cleaning performance and ensures the value-retention of your instruments. Further information is to be found in the brochure "Instrument Reprocessing" from the Arbeitskreis Instrumentenaufbereitung AKI (download from www.a-k-i.org) or from your instrument manufacturer.

1 Wet/dry storage



- 1.1 Wetted instruments should be stored dry. Ensure that they are stored protected from light and heat. Keep the period of storage as short as possible.
- 1.2 Instruments which present organic residue (e.g. blood) after patient treatment could benefit from pre-soaking in a suitable treatment solution. Please ensure the correct process agent chosen for prior soaking is compatible with the washer-disinfector process agents. Otherwise, we recommend dry storage.
- 1.3 If pre-soaking is to be performed, the instruments must be rinsed thoroughly with running water before insertion in the washer-disinfector (WD) to prevent the solution from entering the device.
- 1.4 Instruments may not be soaked overnight in water. Storage in demineralized/distilled water is also associated with negative effects connected with treatment residue (blood etc.).

2 Preparation and pre-cleaning

- 2.1 If instruments are to be subject to manual preparation for cleaning, please ensure that no media or tools/resources are deployed which could damage the surface of the instruments. Never use any aggressive cleaning fluids, wire brushes or metal scourers. Information regarding correct instrument reprocessing is available from your instrument manufacturer.
- 2.2 Insoluble treatment substances (e.g. dental cement, root canal disinfectants, alginates, silicon etc.) must be cleaned manually directly after use. Consult the product data sheets of the treatment substances.
- 2.3 Other substances can also necessitate manual pre-cleaning. These include ultrasound gels and other auxiliary substances.
- 2.4 Hollow body articles (transfer instruments, cannulas etc.) are to be checked for passage. Please observe the specialist information in the user manual.
- 2.5 Instruments must be dismantled for treatment in accordance with the manufacturer's specifications.
- 2.6 Corroded Instruments must be separated. Crusted instruments must be subject to a basic cleaning/servicing.
- 2.7 The KRINKO/BfArM (2012) recommends that instruments of the risk class "Semi-critical B" and "Critical B" should be subject to pre-cleaning directly after use.
- 2.8 The complete cleaning and disinfection of surgical aspirators requires manual pre-cleaning of the interior lumen. Subsequent suction (e.g. using the dental unit) of a minimum of 200 ml water through the surgical aspirator immediately or 10 minutes (at the latest) after treatment will achieve sufficient pre-cleaning. A comparable or more intensive pre-cleaning is permissible.

3 Loading instructions

- 3.1 Generally, ensure that the pattern of loading does not cause any spray shadow. When using wash trays from other manufacturers, ensure that their design (large-scale covered areas) do not generate spray shadow.
- 3.2 Instruments with non-dismountable joints or closable instruments (e.g. tweezers) must be open for treatment.
- 3.3 Easily scratched instruments (e.g. dental mirrors) must be inserted separately with sufficient clearance between the objects. Preparation in a wash tray can cause damage e.g. to the mirror surface.
- 3.4 When using sieve cassettes, ensure that instruments are separated and do not drop masse to the bottom. "Loose material" should be avoided as a matter of course. To do so, you can use the dividing inserts from the MELAG accessories range.

- 3.5 Treat only those instruments in the washer-disinfector which have been expressly authorized for this purpose by the manufacturer. As a rule, these instruments are marked with this symbol,  either directly or in the treatment instructions.
- 3.6 If required, order the treatment instructions from the respective manufacturer in accordance with EN ISO 17664.
- 3.7 Comply with the treatment instructions provided by the instrument manufacturer, especially those pertaining to computability with process agents.
- 3.8 Do not treat any disposable instruments. Disposable instruments are usually marked with this symbol: 
- 3.9 Observe the information provided in the user manual regarding special instruments (dental transfer instruments, ophthalmological instruments, instruments with interior lumen).
- 3.10 If you use non-MELAG accessories to treat instruments in the device, ensure that the compatibility of the accessories with the device and instruments.

4 Routine checks

- 4.1 Check the filters (e.g. in the adapters for transfer instruments) and sieves (coarse and fine filter) regularly and clean/replace where necessary.
- 4.2 Perform the routine controls in accordance with the user manual. The coarse and fine filters should be checked for soiling and cleaned where necessary.
- 4.3 Check the plastic parts (e.g. inserts) for wear at regular intervals and replace them if necessary.

5 Selecting suitable programs

- 5.1 Normal up to strongly soiled instruments: Universal-Program.
Use the Intensive-Program if the Universal-Program does not provide sufficient cleaning power.
- 5.2 Particularly heavily soiled instruments: Intensive-Program.
- 5.3 Un-soiled or only lightly-soiled instruments Quick-Program.
- 5.4 Ophthalmologic instruments: Ophthalmo-Program. DI water required!

6 Process agents

- 6.1 In order to avoid cleaning problems, we have specified the use of process agents adapted to each other. These were set on the machine during installation. Information regarding the product settings is to be found in the installation record or on the container labels.

7 General guidelines

- 7.1 Please note that no common household agents developed for use with a dishwasher cleaner, aroma tabs etc. or indeed any other form of household agents - aluminium foil to prevent the development of stains, vinegar, soda etc. - are used in the cleaning and disinfection device for any purpose whatsoever. These substances impair the treatment process and can cause damage to both the device and the instruments being treated. When metered correctly, the process agents specified for the washer-disinfector achieve the best possible cleaning effects and render superfluous the use of additional agents.
- 7.2 Ensure that the coarse and fine sieves are inserted before removing the rinse arms. This prevents the entry of particles of dirt or rinse arms fastening parts into the pump pit.
- 7.3 Before the coarse and fine filters can be removed for cleaning, it is necessary to check for the presence of any small particles in the filter. These must be removed before the sieve can be removed so that they do not enter the device interior (observe the risk of injury).
- 7.4 After filling with regenerating salt, a short rinsing program should be started to remove any residual salt from the washing chamber.
- 7.5 Avoid long stand times after the rinse-program.
- 7.6 The metering hose should be de-aerated with water before longer pauses (>2 weeks). Please read and observe the information regarding these steps contained in the cleaning and disinfection device user manual.

Principles of the load configuration

The 6 segment principle

All accessories are placed in the basis basket with or without an injector rail. The surface of the basis basket is divided into six segments to ensure the optimal use of space.

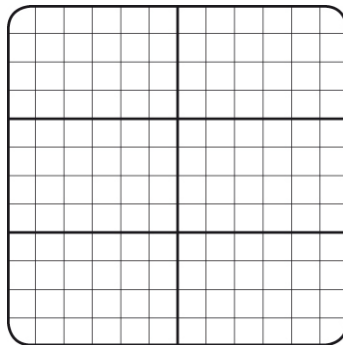

The size of all insert racks, instrument baskets, washing baskets and flex baskets correspond to one or more segments of the basis basket. To this end, the next pages provide one of the following diagrams for each accessory.

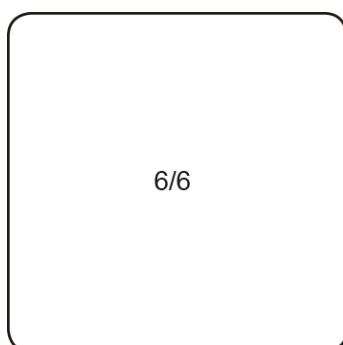
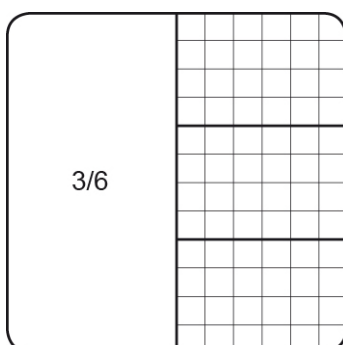
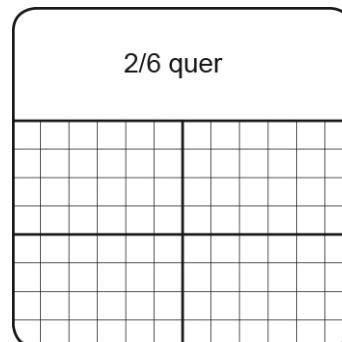
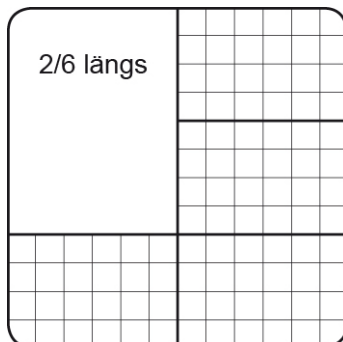
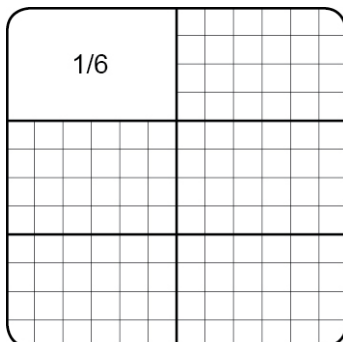

The Flex System

The so-called Flex System was developed on the basis of the 6 segment principle. The flex system consists of instrument baskets of various sizes. The flex baskets can be subject to variable combinations and stacked. This system ensures the optimal use of space in the washing chamber of the washer-disinfector.

Flex baskets may be stacked in max. 2 levels. Attachments for stackable flex baskets can also be used.



WARNING

Stacking more than two flex baskets increases the danger of spray shadow. We can no longer guarantee a successful cleaning performance.

- Stack no more than a max. of two flex baskets.
 - If more than two flex baskets are stacked over each other, the cleaning run requires validation.
-

The following example shows one of a number of many further possible combinations:

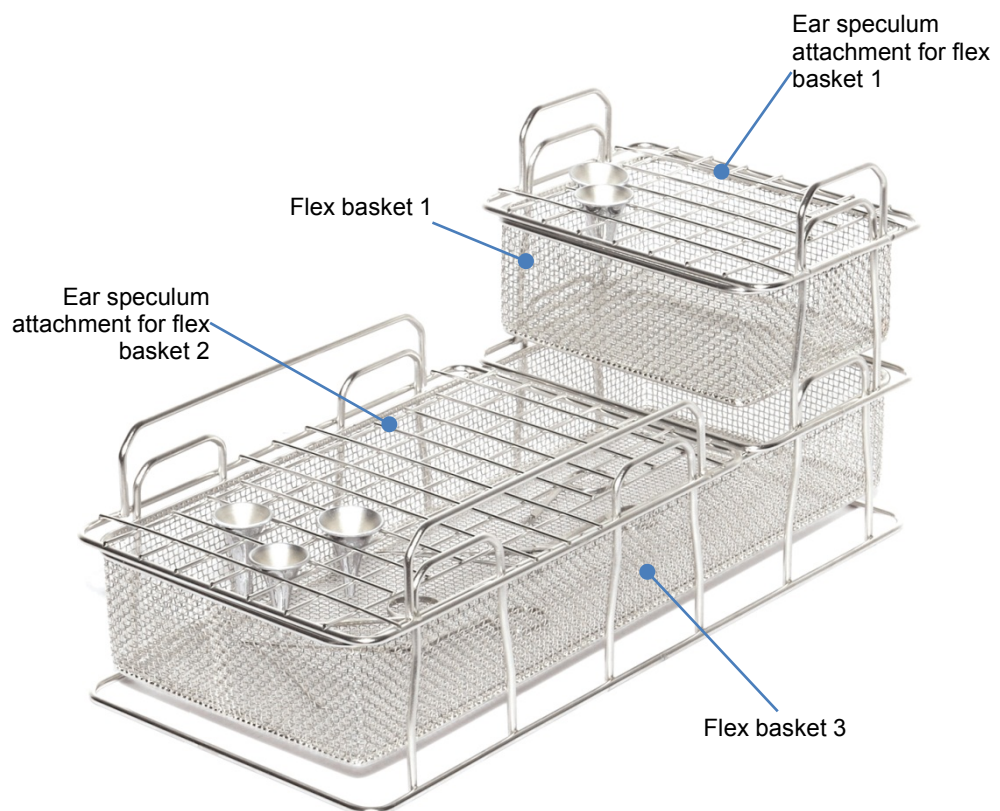

Accessories for exterior cleaning

Basis baskets

The basis of every loading variation is provided by one of the basis baskets. All accessories are placed in the basis basket. Depending on the area of application, loading with insert racks, baskets etc. can be subject to any combination. Loading examples are provided from page 75.

Basis basket without injector rail

Art. no. 00188

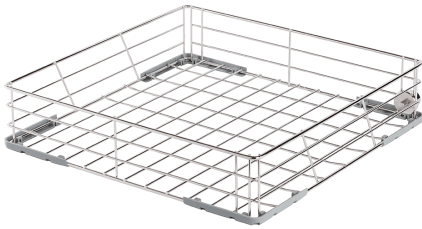

Intended use

If no hollow-bodied instruments are to be rinsed, use the basis basket without injector rail.

Basis basket with injector rail (incl. 11 blind screws)

Art. no. 00200

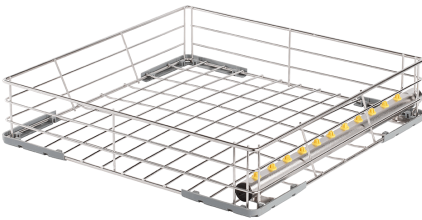

Intended use

If hollow-bodied instrument are to be rinsed, use the basis basket with injector rail (incl. 11 blind screws).

The hollow-bodied instruments are fastened to the injector rail using an adapter or other connection elements.



NOTICE

The use of filter inserts is imperative with hollow-bodied instruments with an interior diameter ≤ 0.8 mm.



PLEASE NOTE

Operation of the basis basket with injector rail and plastic blind screws (art. no. 00200) is permissible only for the initial commissioning or max. three weeks. After this, the blind screws must be replaced with sealing screws from stainless steel (art. no. 80140) or suitable accessories.

Basis basket with injector rail (incl. 11 nozzles and clamp springs)

Art. no. 00197



Intended use

If hollow-bodied instruments are to be rinsed use the basis basket with injector rail (incl. 11 injector nozzles and clamp springs).

The hollow-bodied instruments (e.g. dental surgical aspirator tips) are stuck on the injector nozzles and fixed using clamp springs.



NOTICE

Hollow-bodied instruments with an interior diameter ≤ 0.8 mm require filter inserts.

Basis basket with injector rail (inc. Cleanfinity filter / plastic central filter)

The basis basket with injector rail can be used both with the Cleanfinity filter (see [Cleanfinity filter \(inc. cleaning brush\)](#) [page 66]) and the plastic central filter (see [Plastic central filter](#) [page 65]).

The Cleanfinity filter (art. no. 84630) is a cleanable central filter. The plastic central filter (art. no. 80490) must be replaced as required.

The basis basket is standardly available with an injector rail and Cleanfinity filter (art. no. 84610).

Basis basket with injector rail and Cleanfinity filter

Art. no. 84610



Intended use

The basis basket with injector rail and Cleanfinity filter serves the decontamination of hollow body instruments with an inside diameter ≤ 0.8 mm.

The hollow body instruments are connected to the injector rail using an adapter.

The integrated control display of the injector rail indicates whether a minimum rinse pressure has been reached.



CAUTION

The basis basket with injector rail (inc. Cleanfinity filter / plastic central filter) **has not been approved** for use in the ophthalmology sector.



PLEASE NOTE

No additional filter elements such as ceramic and metal filter discs may be used when using the basis basket with injector rail (inc. Cleanfinity filter / plastic central filter).

Universal adapter and triple distributors are equipped with filter discs upon delivery.

- Before using a basis basket with injector rail (inc. Cleanfinity filter / plastic central filter), remove the filter elements already provided.



PLEASE NOTE

In connection with distance sleeves (art. no. 55120) up to 9 triple distributors (art. no. 73903), double distributor (art. no. 80200) and universal adapters (art. no. 73904) can be screwed on to the injector rail with a central filter.

Application

Insert the basis basket as follows:
 A port for the connection of the injector rail/the blind cap is located on the right-hand rear side of the washing chamber of the washer-disinfector.

Slide the basis basket with the injector rail opening/the blind cap into the washing chamber until it connects to this port.

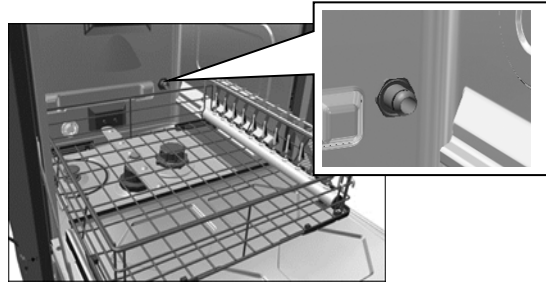

Fig. 1 Inserting the basis basket

Using the injector rail with central filter



PLEASE NOTE

Comply with the following before commissioning the injector rail (inc. Cleanfinity filter / plastic central filter):

- Remove the central filter before connecting adapters to the injector rail.
- Always place instruments on the adapter. If possible, seal non-used adapters with the suitable silicone sealing cap. If the two points above do not bring a remedy, contact the customer services/stockist technician.
- Seal the unused connections on the injector rail with sealing screws (art. no. 80140).



WARNING

Danger of contamination from soiling on the brand-new Cleanfinity filter / plastic central filter.

- Only use a clean central filter.
- Rinse the new central filter thoroughly under running water. Alternatively, the central filter can be cleaned using an empty batch in a program "Rinsing".

Inserting and removing the central filter



WARNING

Danger of contamination by a damaged central filter. The central filter can suffer damage through incorrect insertion. Filtered particles can work loose and penetrate the instruments.

- Check the central filter for damage before inserting it.

Inserting:

- ▶ When using the Cleanfinity filter, make sure that the sealing cap (Fig. 2, pos. a) on the end of the filter has been closed correctly before inserting it. To do so, slide the sealing cap (pos. a) into the filter to its fullest extent and close the bayonet lock by turning it clockwise (Fig. 2, pos. b) into locking position.

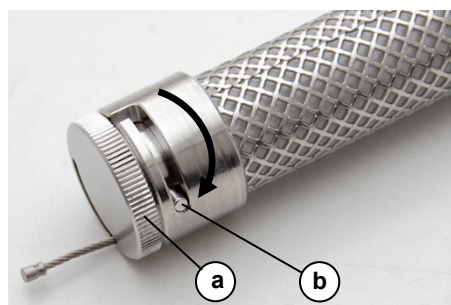

Fig. 2: Cleanfinity filter with bayonet lock

Slide the Cleanfinity filter (Fig. 3) or the plastic central filter (Fig. 4) into the injector rail with the closed end first and turn the grip clockwise until hand-tight.

The central filter has been inserted correctly when the grip is flush with the injector rail.



Fig. 3: Inserting the Cleanfinity filter



Fig. 4: Inserting the plastic central filter

Removal:

Turn the grip of the central filter anti-clockwise and working carefully, pull it out of the injector rail.

Further application usage advice for the Cleanfinity filter is available on page 66 and regarding the plastic central filter on page 65.



PLEASE NOTE

Do not use any tools to remove the central filter so as to prevent damage.



Fig. 5: Removing the central filter without tools



PLEASE NOTE

Please note the following about the period of use of the central filters:

The period of use of the central filters depends on the frequency of use, the loading of the injector rail, the water quality and the degree of soiling of the instruments to be decontaminated. As a result, it can vary strongly. As such, it is not possible to make a general statement as to the interval at which the plastic central filter (art. no. 80490) needs to be replaced or the Cleanfinity filter (art. no. 84630) needs to be cleaned.

Ageing processes mean that the plastic central filter must be changed after a year at the latest, even if the control display indicates sufficient rinse pressure.

You can extend the use time of the central filters by taking into account the following when loading the injector rail:

- Always place instruments on the adapter. If possible, seal non-used adapters with the suitable silicone sealing cap.
- Seal the unused connections on the injector rail with sealing screws (art. no. 80140). This produces a higher rinse pressure and reduces the water flow through the central filter.
- Reduce the number of connections on the injector rail: The lower the number of connections, the longer the use duration of the central filter.
- Avoid using instruments which do not require filtration. Their high water flow reduces the rinse pressure and thus the period of use of the central filter. Universal dental aspirator tips with 11 mm and 16 mm connections can be treated in instrument baskets in a standing position. The distal end must point upwards. This must be considered separately during validation.
- Rinse coarse water-insoluble material (e.g. prophylaxis powder, dental cement, composite filler etc.) from the instruments before decontamination in the washer-disinfector.

Fitting the injector rail with adapters



WARNING

Danger of contamination from reduced filtration and cleaning performance. Screwing on accessories too deeply can damage the central filter or impede the water flow in the instrument.

- Remove the central filter before placing adapters on the injector rail.
- Check the thread lengths with the thread length meter provided.
- Use flat washers for adapters with a thread length > 4.

1. Remove the central filter.
2. With adapters with a thread length of > 4 mm add as many flat washers until the thread protrudes by max. 4 mm (Fig. 6 **Fehler! Verweisquelle konnte nicht gefunden werden.**)
3. Screw the connections and the adapters into the injector rail. Always place instruments on the adapter. If possible, seal non-used adapters with the suitable silicone sealing cap. Seal the unused connections on the injector rail with sealing screws.
4. Insert the central filter in the injector rail.
5. Should the central filter becomes difficult to slide in or becomes blocked, use further flat washers.

Please note that under certain circumstances; even original MELAG accessories can have a thread length greater than 4 mm.

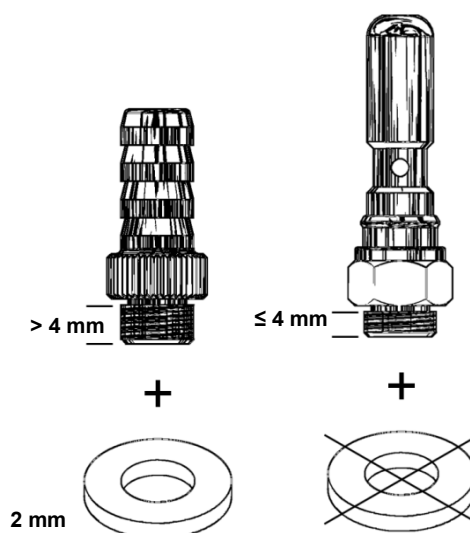

Fig. 6: Thread lengths of the adapter

Checking the control display

The integrated control display of the injector rail triggers once a minimum rinse pressure has been reached. The rinse pressure achieved depends on the state of the central filter and the fitting of the injector rail.

**WARNING**

Danger of contamination from reduced filtration and cleaning performance. Use the control display to check whether the central filter is functioning correctly.

- Activate the control display before every program run.
- Check the control display after every program run.

Activating the control display:

1. Press the pin of the control display into the injector rail so that it returns to its starting position.
2. Start a disinfection program.
3. After the program run, check whether the control display has triggered.
4. If the control display pin protrudes from the injector rail, the central filter can be used further.
5. If the pin **does not** protrude from the control display after the program run, clean the **Cleanfinity filter (see Cleanfinity filter (inc. cleaning brush) [page 66])** or replace the plastic central filter.
6. If the injector rail was correctly sealed and the control display has still not triggered, change the central filter.

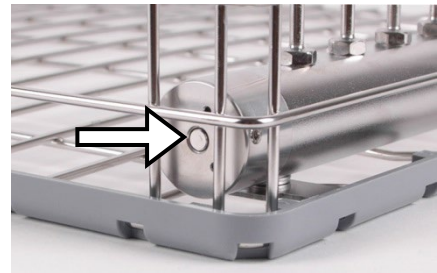

Fig. 7: Control indicator before program start

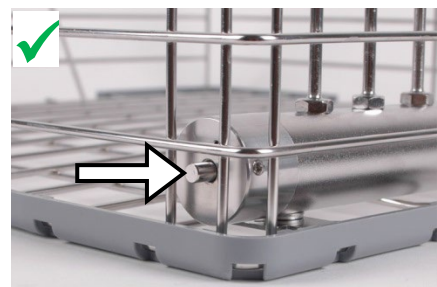

Fig. 8: State of the central filter without fault

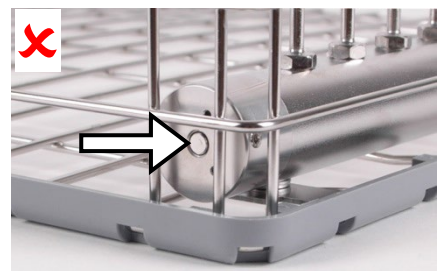

Fig. 9: The central filter must be replaced

If the control display has not triggered the first time and the injector rail has been correctly fitted with instruments/seals, a safety extra allows this program run can be qualified as a success.

Malfunctions and their remedy

Perform all the following measures before contacting the service dept.

Malfunctions	Remedy
The central filter is new, but the pin does not spring out of the control display.	<ol style="list-style-type: none"> 1. Check whether the central filter has been fitted correctly. 2. Check the loading of the injector rail. Seal the unused connections with sealing screws (art. no. 80140). 3. Always place instruments on the adapter. If possible, seal non-used adapters with the suitable silicone sealing cap. If the two points above do not bring a remedy, contact the customer services/stockist technician.
The pin on the control display cannot be pressed in.	Contact the service department/stockist technician.

Information for validation with a central filter

- ▶ Disinfect brand new central filters in the washer-disinfector before performing the validation. The partial cycle "Disinfection" performed in maintenance mode is sufficient.
- ▶ The system conditions mean that the rinse pressure measured behind the central filter is lower than the rinse pressure measured by the device.
- ▶ Rinse pressures ≥ 100 mbar - measured behind the central filter - during cleaning and disinfection lie within the specifications.

Fitting to a new injector rail with Cleanfinity filter

The "Injector rail with Cleanfinity filter" conversion set (art. no. 84630) requires a size 3 Allen key and a TX20 hex socket key.

You do not require a conversion set for upgrading from a plastic central filter to a Cleanfinity filter or vice versa.



NOTICE

Read the application usage advice before using the accessories.

1. Unscrew the two screws on the underside of the basis basket using the appropriate key and remove the old injector rail.
2. Dispose of the screws and distance sleeves of the old injector rail.
3. Insert the new injector rail in the basis basket.
4. Observe the alignment of the injector rail when inserting. The central filter grip must be positioned in the aperture of the basis basket.
5. Fix the injector rail with the screws and distance sleeves included in the scope of delivery. Use the correct key.
6. When using the injector rail with central filter comply with step [Using the injector rail with central filter](#) [page 13].



PLEASE NOTE

No additional filter elements may be used when using the basis basket with injector rails and central filters.

Insert racks

Insert rack for 3 MELAstore-Trays/ sieve cassettes

Art. no. 00180



Space requirements

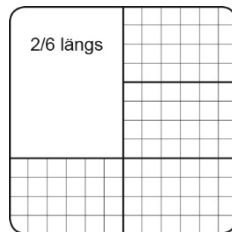

Insert rack for 4 MELAstore-Trays/ sieve cassettes

Art. no. 80040

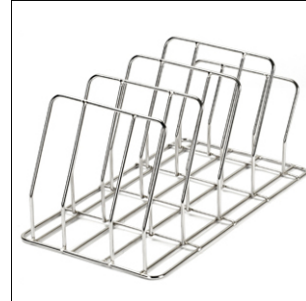

Space requirements

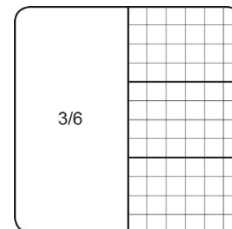

Intended use

This insert rack facilitates the acceptance of sieve cassettes or MELAstore-Trays.

Application

Place the sieve cassettes in the insert racks with their latch pointing upwards. This prevents the instruments from falling downwards upon removal of the sieve cassette should the latch open (see Fig. 10 **Fehler! Verweisquelle konnte nicht gefunden werden.**).

In the interests of simple loading and removal in the insert rack, the sieve cassette should be inclined towards the device door.

We recommend use of a MELAG sieve cassette. When using sieve cassettes from other manufacturers, please observe the corresponding usage advice.

The MELAstore-Tray 200 is inserted in the insert rack for 3 or 4 sieve cassettes.

Always place the MELAstore-Tray 200 in the insert racks with their latch pointing to the rear (see Fig. 11).

We should like to point out that the number and alignment of the silicon bar in the MELAstore-Tray influences the cleaning outcome.

Used in conjunction with

- Sieve cassette, art. no. 00185
- Sieve cassette with dividing insert and protrusion guard, art. no. 00185
- MELAstore-Tray 100, art. no. 01181
- MELAstore-Tray 200, art. no. 01182



Fig. 10: Fore view in the device



Fig. 11: Fore view in the device

Insert rack for MELAstore-Tray 50 (12 pcs.)/MELAstore-Tray 100 (6 pcs.)

Art. no. 80810

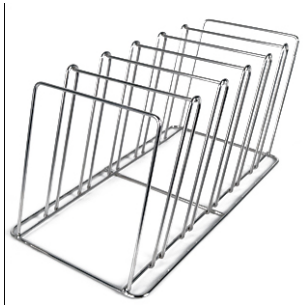

Space requirements

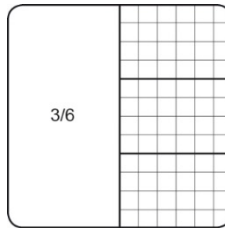

Intended use

This insert rack serves the direct acceptance of the MELAstore Trays 50 und 100. It is not stackable.

Application

Place the MELAstore-Trays in the insert racks with their latch pointing to the rear (see Fig. 12).

In the interests of simple loading and removal in the basis basket, the MELAstore-Trays should be inclined towards the device door.

Max. 6 MELAstore-Trays 100 or 12 MELAstore-Trays 50 (stacked on top of each other) fit in the insert rack.

The number and alignment of the silicon bar in the MELAstore-Tray influence the cleaning outcome.

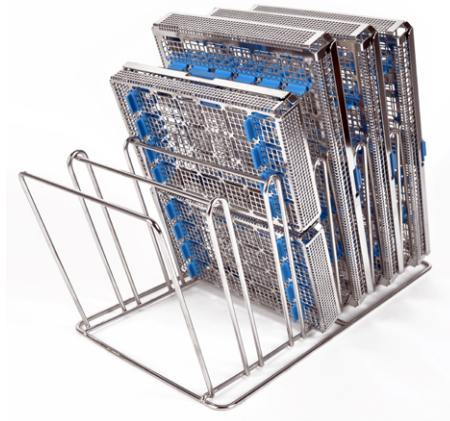

Fig. 12: Loading example MELAstore-Tray 100 and MELAstore-Tray 50



PLEASE NOTE

Instruments must be dismantled for treatment in accordance with the manufacturer's specifications. Please ensure that you observe the information provided by the instrument manufacturer.

Used in conjunction with

- MELAstore-Tray 50, art. no. 01180
- MELAstore-Tray 100, art. no. 01181

Insert rack for 5 trays / 10 half-trays

Art. no. 80590



Space requirements

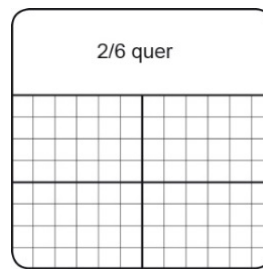

Intended use

The tray mount accommodates instrument trays (LxWxH) 24 x 18 x 1.7 cm to max. 29 x 19 x 2.0 cm. It is not stackable.

Application

Remove the coarse soiling from the trays before treatment in the device.

Always place multiple trays in the tray mount with the impression pointing in the same direction.

Depending on the size, 5 - 10 instrument trays can be positioned (see Fig. 13).

Check the instrument trays for soiling after treatment.



Fig. 13: Combination example



NOTICE

- Only treat instrument trays which have been cleared by the manufacturer for treatment in a washer-disinfector. If required, order the treatment instructions from the respective manufacturer in accordance with EN ISO 17664.
- Please note that a temperature of up to 95 °C can be reached in the disinfection phase.

Instruments and washing baskets

Instrument basket compact

Art. no. 00195



Space requirements

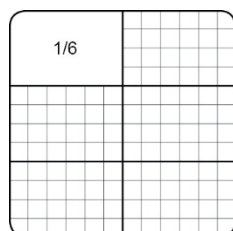

Instrument basket standard

Art. no. 00184



Space requirements

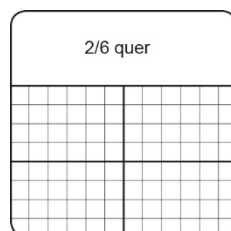

Instrument basket >G<

Art. no. 00131



Space requirements

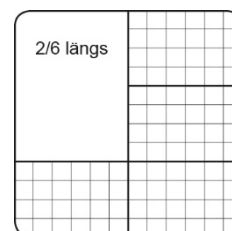

Intended use

The instrument basket facilitates the treatment of standing instruments e.g. tweezers, probes, mirrors, scissors, clamps, nasal specula etc. It cannot be stacked.

Universal dental aspirator tips with 11 mm and 16 mm connections can be treated in instrument baskets in a standing position. The distal end must point upwards. This must be considered separately during validation.

Application

The instrument basket is placed in the basis basket.

The instruments are placed in the instrument basket with their grip ends facing downwards. We recommend the use of a needle tip plate (art. no. 00186) for instruments with two working ends. Heavy soiling on the instruments (e.g. dental cement or similar) must be removed from the instrument directly after their use. Any encrusted residue must first be removed in an ultrasound bath.



CAUTION

Danger of injury from sharp or pointed instruments.

- Wear suitable hand protection.



PLEASE NOTE

Use only those instruments designed by their manufacturer for automatic treatment in a washer-disinfector. Please ensure that you observe the information provided by the instrument manufacturers.

Insert all mirrors and other sensitive instruments in the instrument basket in such a fashion so that they do not cover each other or become damaged by banging into other instruments.

**PLEASE NOTE**

Instruments must be dismantled for treatment in accordance with the manufacturer's specifications. Please ensure that you observe the information provided by the instrument manufacturers.

Used in conjunction with

- Needle tip plate for instrument basket, art. no. 00186

Needle tip plate for instrument basket

Art. no. 00186

**Intended use**

The needle tip plate prevents pointed instruments from protruding or sliding through the meshing of the instrument basket.

Application

The needle tip plate is connected lengthways in the lower level of the instrument basket.

Used in conjunction with

- Instrument basket standard, art. no. 00184
- Instrument basket G, art. no. 00131
- Instrument basket compact, art. no. 00195

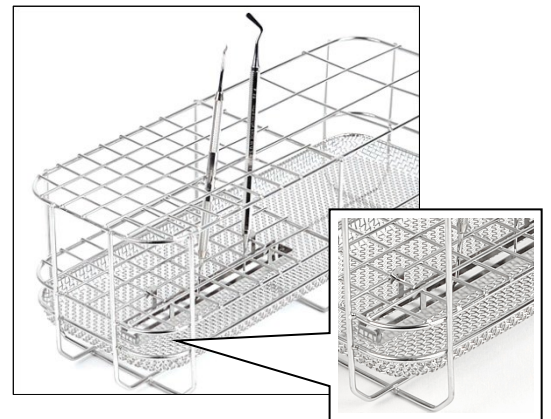

Fig. 14: Inserted needle tip

Small parts container

Art. no. 00133



Intended use

The small parts container facilitates the safe decontamination of very small instruments (e.g. drill bits) in order to prevent them from becoming lost in the washing chamber or blocking its apertures.

Application

The small parts container is fitted with small instrument (e.g. drill bits) and both half shells are to be locked with the aid of the locking mechanism. The small parts container can be placed lying down or standing up in the instrument or flex basket.



PLEASE NOTE

For especially sensitive instruments e.g. endo instruments, we recommend use of the decontamination accessories provided by their manufacturer.

Used in conjunction with

- Instrument basket compact art. no. 00195
 - Instrument basket G, art. no. 00131
 - Instrument basket standard, art. no. 00184
 - Flex basket 1, art. no. 80010
 - Flex basket 2, art. no. 80020
 - Flex basket 3, art. no. 80030
-

Stackable insert racks and baskets (flex system)

The flex baskets can be subject to variable combinations and stacked. Page 10 lists one of a number of many combinations in the flex baskets.

Flex basket 1

Art. no. 80010



Space requirements

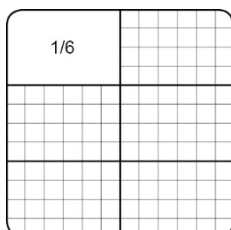

Flex basket 2

Art. no. 80020



Space requirements

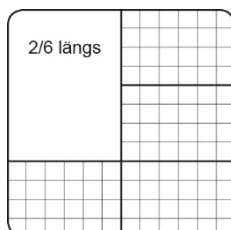

Flex basket 3

Art. no. 80030

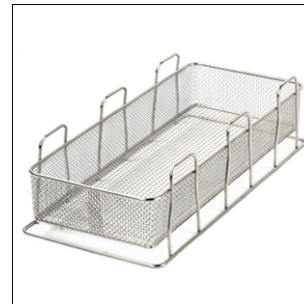

Space requirements

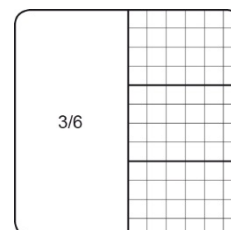

Intended use

The flex basket facilitates the treatment of instruments lying flat e.g. tweezers, mirrors, scissors etc.

Application

The flex basket is placed in the basis basket and may be stacked in max. two levels. Attachments for stackable flex baskets can also be used.



PLEASE NOTE

Avoid poor load configurations, e.g. repeated stacking of the instruments. Otherwise, the cleaning performance could be compromised.

In accordance with national regulations regarding the cleaning test, the following limitations apply to the maximum number of lying hinged instruments per flex basket:

- Flex basket 1: 3 pieces
- Flex basket 2: 7 pieces
- Flex basket 3: 10 pieces

As part of validation, adaptations of program parameters may be necessary.



PLEASE NOTE

In order to optimise the cleaning result, decontaminate hinged instruments such as scissors and clamps with the intended insert racks (art. no. 80110 and 80120), see page 28/29.

Used in conjunction with

- Flex basket 1, art. no. 80010
- Flex basket 2, art. no. 80020
- Flex basket 3, art. no. 80030
- Ear speculum attachment Flex 1, art. no. 80070, 80080,
- Ear speculum attachment Flex 2, art. no. 80070, 80090,
- Ear speculum attachment Flex 3, art. no. 80070, 20100,
- Insert rack for impression trays, scissors and clamps, art. no. 80110
- Insert rack for hinged instruments, art. no. 80120
- Injector basket Flex 1, art. no. 80740

Flex basket 6

Art. no. 80255

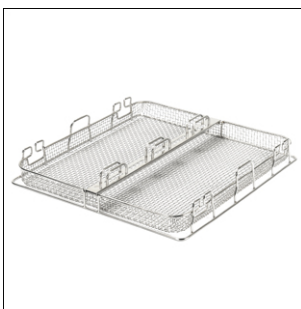

Space requirements

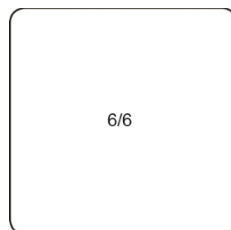

Intended use

Flex basket 6 facilitates the decontamination of long instruments up to 40 cm e.g. cannula, tweezers, scissors, trocars, suitable endoscope accessories etc.

Application

Flex basket 6 can be used as a basis under the flex baskets 1, 2, 3 and under the flex basket specula.

Hoses must be installed without kinks and sagging, preferably using the hose conduit.

The hoses may not be pinched-off by the flex baskets placed on the traverse.



Fig. 15: Installing the hose without kinks or sagging with the hose conduit



WARNING

Stacking more than two flex baskets increases the danger of spray shadow. We can no longer guarantee a successful cleaning performance.

- Stack no more than a max. of two flex baskets.
- If more than two flex baskets are stacked over each other, the cleaning run requires validation.

**PLEASE NOTE**

Avoid improper loading combinations such as multiple stacking of the instruments. Otherwise, the cleaning performance could be compromised.

In accordance with national regulations regarding the cleaning test, the following limitations apply to the maximum number of lying hinged instruments per flex basket:

- Flex basket 6: 20 pieces

As part of validation, adaptations of program parameters may be necessary.

**PLEASE NOTE**

In order to optimise the cleaning result, decontaminate hinged instruments such as scissors and clamps with the intended insert racks (art. no. 80110 and 80120), see page 28/29.

Used in conjunction with

- Insert rack for impression trays, scissors and clamps, art. no. 80110
- Insert rack for hinged instruments, art. no. 80120
- Flex basket specula, art. no. 80410
- Flex basket 1, art. no. 80010
- Flex basket 2, art. no. 80020
- Flex basket 3, art. no. 80030
- Injector basket Flex 1, art. no. 80740

Injector basket Flex 1

Art. no. 80740

**Space requirements**

1/6	

Intended use

The injector basket flex 1 serves exclusively the cleaning of ultrasonic and air scaler tips (e.g. ZEG tips). Decontamination with a torque wrench connected is possible, as far as this has been approved by the manufacturer for automatic decontamination. Max. three flex 1 injector baskets may be inserted.

**NOTICE**

Ultrasonic and scaler tips require the fine filtration of the liquor. As such, the injector basket Flex 1 may only be operated with the filter disc housing or the central filter.

**NOTICE**

The injector basket Flex 1 extends the connections of the injector rail. It may not be combined with further multi-way distributors.

Application

The injector basket Flex 1 is connected with two connections on the injector rail (with central filter) or two filter disc housings (injector rail without central filter) via two connection hoses (Fig. 16, pos. a). It is stackable on the flex baskets 1, 2, 3 and 6.

The adapters for tips are screwed into the free connections of the injector basket Flex 1.

Depending on the available space, the injector basket Flex 1 can also be inserted with the instruments pointing downwards.

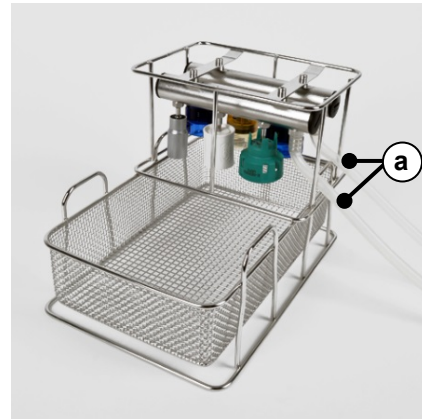

Fig. 16: Installing the hose without kinks or sagging with the hose conduit



NOTICE

Failure to cover all the connections on the connections or the injector rail can impair the cleaning result.

- Always place instruments on the adapter. If possible, seal non-used adapters with the suitable silicone sealing cap.
- Seal the unused connections with sealing screws (art. no. 80140).



PLEASE NOTE

The application of the injector basket Flex 1 with plastic blind screws is only allowed for the first commissioning with a maximum of three weeks.

Used in conjunction with

- Basis basket with injector rail (incl. plastic central filter), art. no. 80440
- Basis basket with injector rail and Cleanfinity filter, art. no. 84610
- Filter disc housing (incl. ceramic filter disc), art. no. 73905
- Flex basket 1, art. no. 80010
- Flex basket 2, art. no. 80020
- Flex basket 3, art. no. 80030
- Adapter for tips, art. no. 80750, 80751, 80752, 80756, 80760, 80790

Insert rack for impression trays, scissors and clamps

Art. no. 80110 (has superseded the precursor model with the art. no. 00182)

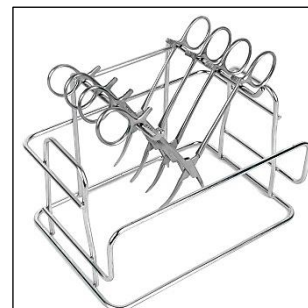
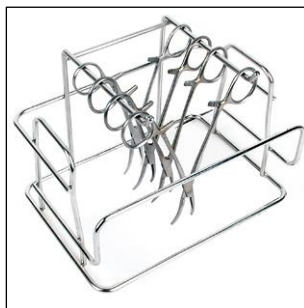

Space requirements

1/6	

Intended use

The insert rack serves the treatment of up to eight dental impression trays as well as scissors, clamps and similar hinged instruments.

Application

The impression trays are hung successively on the hooks. The scissors, clamps and other similar hinged instruments are to be pulled open and placed in the insert rack or placed on a bracket clip with the operating end facing downwards (Fig. 17). The insert rack is placed in the basis basket. Even when used with longer scissors, clamps and similar hinged instruments, the insert rack is stackable via the flex baskets 1, 2, 3 and 6.

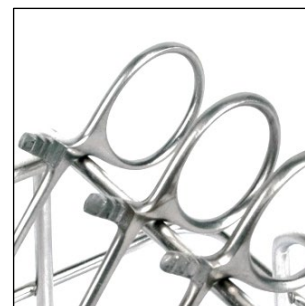

Fig. 17: Scissors lie on the bracket clip



CAUTION

Danger of injury from sharp or pointed instruments!

- For your own safety and to avoid injuries when loading the instrument and washing baskets, always wear other suitable hand protection.



PLEASE NOTE

Long pointed objects can push through the basis basket, thus blocking the rinse arm. Ensure that the rinse arm can turn. If necessary, the instruments can be distributed in other flex baskets.



PLEASE NOTE

Instruments must be dismantled for treatment in accordance with the manufacturer's specifications. Please ensure that you observe the information provided by the instrument manufacturers.

Used in conjunction with

- Flex basket 1, art. no. 80010
- Flex basket 2, art. no. 80020
- Flex basket 3, art. no. 80030
- Flex basket 6, art. no. 80255

Insert rack for hinged instruments

Art. no. 80120 (has superseded the precursor model with the art. no. 00183)

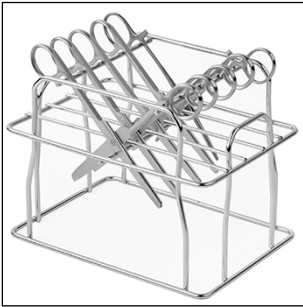

Space requirements

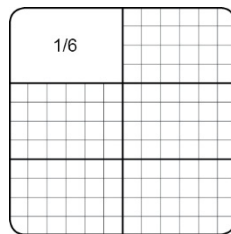

Intended use

The insert rack for hinged instruments facilitates the treatment of hinged instruments e.g. scissors, clamps, needle holders etc.

Application

The instruments are extended and hung below in the insert rack with their grip ends pointing downwards. The insert rack is placed in the basis basket. It is stackable via the flex baskets 1, 2, 3 and 6. It can also be stacked on the insert rack for impression trays.



PLEASE NOTE

Instruments must be dismantled for treatment in accordance with the manufacturer's specifications. Please ensure that you observe the information provided by the instrument manufacturers.

Used in conjunction with

- Flex basket 1, art. no. 80010
- Flex basket 2, art. no. 80020
- Flex basket 3, art. no. 80030
- Flex basket 6, art. no. 80255

Flex basket specula

Art. no. 80410



Space requirements

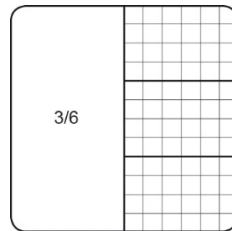

Intended use

The flex basket specula facilitate the treatment of up to 8 Kristeller specula or 16 Cusci/Semm specula.

Application

The flex basket specula is inserted directly in the basis basket. Up to 2 flex basket specula can be stacked next to each other on the flex basket 6.



PLEASE NOTE

Avoid unsuitable load configurations. Otherwise, the cleaning performance could be compromised.



Fig. 18: Loading example flex basket specula

A) Instructions for Kristeller specula

If two instruments are placed next to each other in a segment, the arches in the longitudinal struts of the basis basket (Fig. 19, detail 1) serve as a central fixing for the broad Kristeller specula and as a dividing insert with narrow Kristeller specula.

The inclination of short instruments can be increased to improve flow-off. The ends of the Kristeller specula's are placed on the longitudinal struts in the floor of the washing basket (Fig. 19, detail 2).

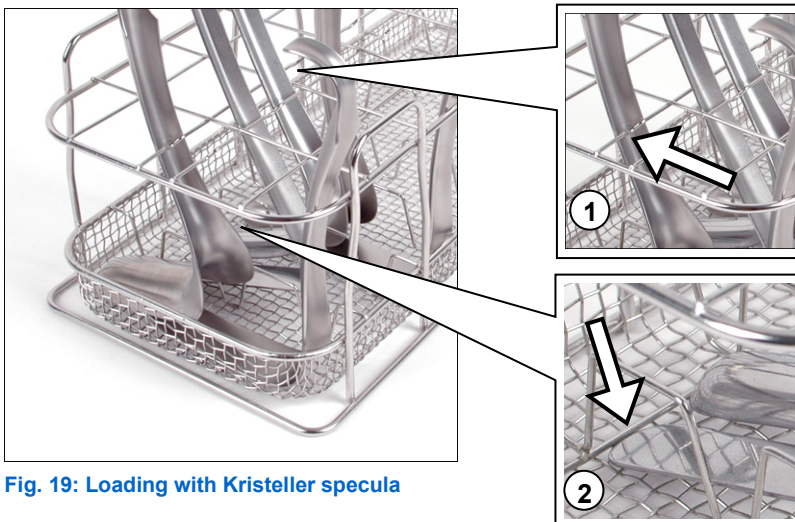

Fig. 19: Loading with Kristeller specula

B) Instructions for Cusco/Semm specula

Cusco specula are opened and hung over the longitudinal struts.



Fig. 20: Load with Cusco/Semm specula

Used in conjunction with

- Flex basket 6, art. no. 80255

Attachments for stackable baskets (Flex system)

Ear speculum attachment Flex 1

Mesh width 14 mm,
for up to 50 ear specula

Art. no. 80070



Space requirements

1/6	

Mesh width 20 mm,
for up to 24 ear specula

Art. no. 80080



Space requirements

1/6	

Intended use

In combination with a flex basket, the ear speculum attachment facilitates the treatment of ear specula.

Application

The attachment is set on the flex baskets 1, 2 or 3. The ear specula are hung below in the cavities with their pointed side facing downwards. The attachments can be partially loaded with the flex baskets 1, 2, 3 or be used comprehensively.

**PLEASE NOTE**

Ensure that the ear specula do not come into contact with each other. Use only those instruments designed for automatic treatment in a washer-disinfector. Please ensure that you observe the information provided by the instrument manufacturers.

Used in conjunction with

- Flex basket 1, art. no. 80010
- Flex basket 2, art. no. 80020
- Flex basket 3, art. no. 80030
- Fixing clamp Flex attachment, art. no. 80420

Ear speculum attachment Flex 2

Art. no. 80090, meshing width 20 mm, for up to 60 ear specula.

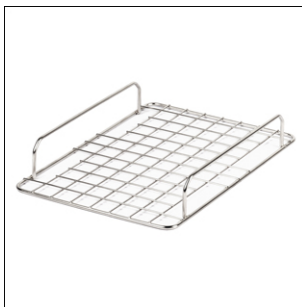
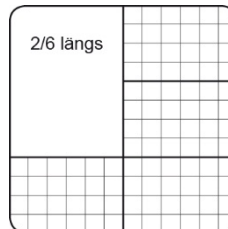
**Space requirements****Intended use**

In combination with a flex basket, the ear speculum attachment facilitates the treatment of ear specula.

Application

The ear speculum attachment is set on the flex baskets 1, 2 or 3. The ear specula are hung below in the cavities with their pointed side facing downwards.

The ear speculum attachments can be partially loaded with the flex baskets 1, 2 or 3 or be used comprehensively e.g. one ear speculum attachment on two flex baskets 1.

**PLEASE NOTE**

Ensure that the ear specula do not come into contact with each other. Use only those instruments designed for automatic treatment in a washer-disinfector. Please ensure that you observe the information provided by the instrument manufacturers.

Used in conjunction with

- Flex basket 1, art. no. 80010
- Flex basket 2, art. no. 80020
- Flex basket 3, art. no. 80030
- Fixing clamp Flex attachment, art. no. 80420

Ear speculum attachment Flex 3

Art. no. 80100, meshing width 20 mm, for up to 96 ear specula.

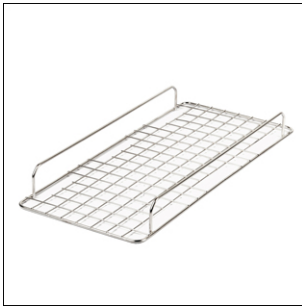

Space requirements

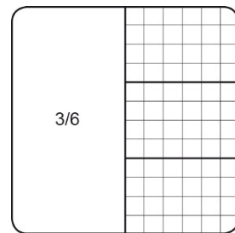

Intended use

In combination with a flex basket, the ear speculum attachment facilitates the treatment of ear specula.

Application

The attachment is set on the flex baskets 1, 2 or 3. The ear specula are hung below in the cavities with their pointed side facing downwards.

The attachments can be partially loaded with the flex baskets 1, 2, 3 or be used comprehensively e.g. 1 ear speculum attachment on 3 flex baskets 1.



PLEASE NOTE

Ensure that the ear specula do not come into contact with each other. Use only those instruments designed for automatic treatment in a washer-disinfector. Please ensure that you observe the information provided by the instrument manufacturers.

Used in conjunction with

- Flex basket 1, art. no. 80010
- Flex basket 2, art. no. 80020
- Flex basket 3, art. no. 80030
- Fixing clamp Flex attachment, art. no. 80420

Attachment for flex basket with brackets

Art. no. 80435



Space requirements

1/6	

Intended use

The attachment for the flex basket facilitates the treatment of e.g. nasal specula in combination with a flex basket.

Application

The attachment is placed on flex basket 1 and fixed with the fixing clamp (see [Bracket for Flex attachment](#) [page 35]). The grip ends of the nasal specula are placed in cavities with the working ends open. Depending on the sizes, between 9 and 12 nasal specula can be treated per attachment.



PLEASE NOTE

Instruments must be dismantled for treatment in accordance with the manufacturer's specifications. Please ensure that you observe the information provided by the instrument manufacturers.



Fig. 21: Attachment in the flex basket

Used in conjunction with

- Flex basket 1, art. no. 80010
- Flex basket 2, art. no. 80020
- Flex basket 3, art. no. 80030
- Fixing clamp Flex attachment, art. no. 80420

Bracket for Flex attachment

Art. no. 80420



Intended use

Fixes the flex attachments to the flex basket.

Application

As Fig. 22 shows, the clips of the fixing clamps are fastened to the handle of the attachment from inside and the clamps pressed under the flex basket handle.



Fig. 22: Hooked-in fixing clamp

Used in conjunction with

- Ear speculum attachment Flex 1 (meshing width 14 mm), art. no 80070
- Ear speculum attachment Flex 1 (meshing width 20 mm), art. no 80080
- Ear speculum attachment Flex 2 art. no. 80090
- Ear speculum attachment Flex 3 art. no. 80100
- Attachment for nasal specula Flex 1 (incl. 2 brackets), art. no. 80435
- Flex basket 1, art. no. 80010
- Flex basket 2, art. no. 80020
- Flex basket 3, art. no. 80030

Instrument holder for flex baskets (60 pcs.)

Art. no. 80395



Intended use

The instrument holder serves the ordered accommodation of instruments in the washing basket and provides security during the cleaning procedure. This avoids a situation in which the instruments slide around in the washing basket, thereby causing damage. This also affects improved instrument drying results. Hinged instruments can be held continuously open.

Application

The instrument holder can be inserted in the washing basket individually. Individual instrument holders can be separated from the strip (x 6 pieces) as required by twisting off or cutting. They can be deployed in the washing basket separately.

An silicone bar has two levels for instrument acceptance. Only a single level may be filled with an instrument at any one time. Instruments with a diameter of 3-6 mm are inserted in level 1; instruments with a diameter of 6-12 mm are inserted in level 2.

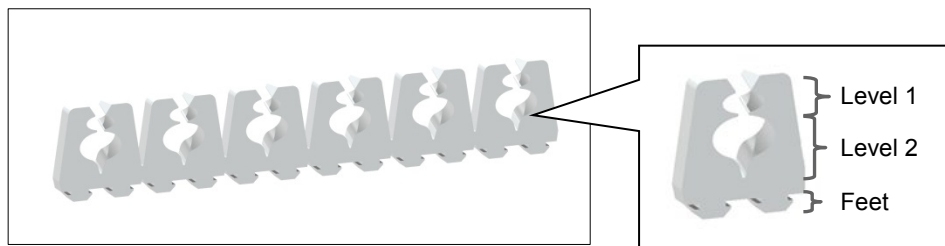

Fig. 23: Instrument holders



CAUTION

Danger of injury from sharp or pointed instruments!

- For your own safety and to avoid injuries when loading the instrument and washing baskets, always wear other suitable hand protection.

A minimum of two instrument holders are required per instrument. Multiple instrument holders may be required for hinged instruments.

The instrument holders are fixed to the washing basket individually by pushing their feet into the meshing of the washing basket.

Replace the instrument holders if they show signs of abrasion and wear.

Used in conjunction with

- Flex basket 1, art. no. 80010
- Flex basket 2, art. no. 80020
- Flex basket 3, art. no. 80030
- Flex basket 6, art. no. 80255

Sieve cassettes and inserts

Sieve cassette

Art. no. 00185 (sieve cassettes),

Art. no. 80185 (sieve casset with dividing insert and protrusion guard)

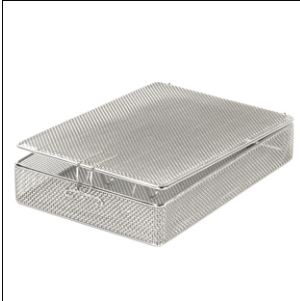

Intended use

The sieve cassettes facilitate the treatment of instrument sets or larger quantities of individual instruments in combination with the insert rack for sieve cassettes.

Application

The instruments are inserted flat in the sieve cassettes, which is then closed with the lid.

When using an insert rack, the sieve cassette is placed in the insert rack on edge and with the latch facing upwards.



CAUTION

Sharp and pointed instruments may protrude through the sieve cassette meshing. This could result in serious injury.

- Use the protrusion guard when treating sharp and pointed instruments.



PLEASE NOTE

Instruments must be dismantled for treatment in accordance with the manufacturer's specifications. Please ensure that you observe the information provided by the instrument manufacturers.



PLEASE NOTE

Avoid improper loading combinations such as multiple stacking of the instruments. Otherwise, the cleaning performance could be compromised.

Used in conjunction with

- Insert rack for 3 MELAstore-Trays/sieve cassettes, art. no.00180
- Insert rack for 4 MELAstore-Trays/sieve cassettes, art. no.80040

Art. no. 00185 used in conjunction with

- Dividing insert for sieve cassettes, art. no. 00191
- Protective insert for sieve cassettes, art. no. 00189
- Protrusion guard for the sieve cassette, art. no. 00190

Dividing insert for sieve cassette

Art. no. 00191

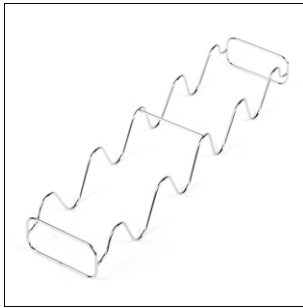

Intended use

The dividing insert facilitates the stability of the instruments in the sieve cassette so as to avoid spray shadow.

Application

The dividing inserts are inserted into the sieve cassette lengthways. The instruments are divided lengthways across the resulting three segments (see Fig. 24). It is intended that the instruments are able to move.



Fig. 24: Dividing insert for perforated cartridges

Used in conjunction with

- Sieve cassette, art. no. 00185

Protrusion guard for the sieve cassette

Art. no. 00190



Intended use

The protrusion guard prevents the protrusion of sharp instruments through the sieve cassette and thus protects the instruments with sensitive tips.

Application

The protrusion guard is inserted transversely in one end of the sieve cassette. The instruments are inserted in the sieve cassette in such a way that the pointed ends point in the direction of the protrusion guard.



CAUTION

Sharp and pointed instruments may protrude through the sieve cassette meshing.

This could result in serious injury.

- Use the protrusion guard when treating sharp and pointed instruments.
- Watch out for pointed tips protruding from the side.



Fig. 25: Protrusion guard used

Used in conjunction with

- Sieve cassette, art. no. 00185:

Protective insert for the sieve cassette

Art. no. 00189

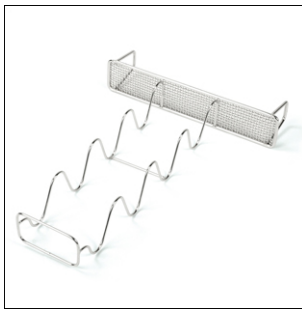

Intended use

The protective insert for the sieve cassette is a combination of a dividing insert and protrusion guard and provides security for the instruments in the sieve cassette. This can help to avoid spray shadow. The protective insert for the sieve cassette also prevents the protrusion of sharp instruments through the sieve cassette and thus protects the instruments with sensitive tips.

Application

The protective insert is inserted into the sieve cassette lengthways. The instruments are divided lengthways across the resulting three segments. The instruments are placed in the protective insert in such a fashion that the pointed ends point through the meshing.

Used in conjunction with

- Sieve cassette, art. no. 00185

MELAstore-Tray 50

Art. no. 01180



MELAstore-Tray 100

Art. no. 01181

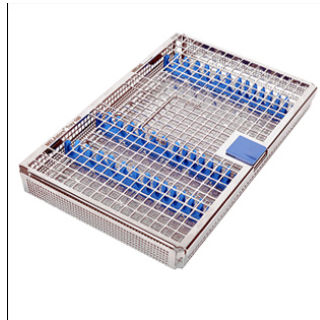

MELAstore-Tray 200

Art. no. 01182



Intended use

The MELAstore-Trays 50, 100 and 200 facilitate the treatment of larger quantities of single instruments and can be stored in MELAstore-Boxes. Comply with the application usage advice of the MELAstore-Box 100 and 200.

The blue silicone bar serves the ordered accommodation of instruments in the MELAstore-Tray and provides security during the cleaning procedure. This also effects improved instrument drying results. Hinged instruments can be held continuously open.

Cheek retractors can only be treated in the MELAstore-Tray 100 or MELAstore-Tray 200.



PLEASE NOTE

Brand new MELAstore-Trays must be subjected to automatic cleaning and disinfection before their first use.

Application

The silicon bar can be inserted in the MELAstore-Tray individually. As required, individual silicon bar can be separated (cutting) and used separately.

The feet are pressed into the niches in the MELAstore-Trays to fix them.

Use as few silicon bar as possible in a single MELAstore-Tray to avoid unwashed areas.

Only a single level of the silicone bar may be filled with an instrument at any one time. Instruments with a diameter of 5 mm are inserted in level 1; instruments with a diameter of 10 mm are inserted in level 2.

A second level can be used. This must be considered separately during validation.

The number and alignment of the silicon bar in the MELAstore-Tray influence the cleaning outcome.

Replace the silicon bar if they show signs of abrasion and wear.

Silicon bar for:

- MELAstore-Tray 50, art. no. 82960
- MELAstore-Tray 100, art. no. 82970
- MELAstore-Tray 200, art. no. 82980

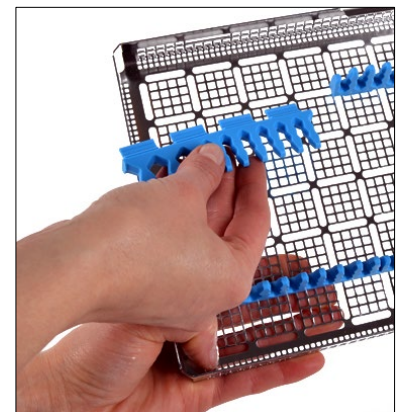

Fig. 26: Inserting the silicon bar

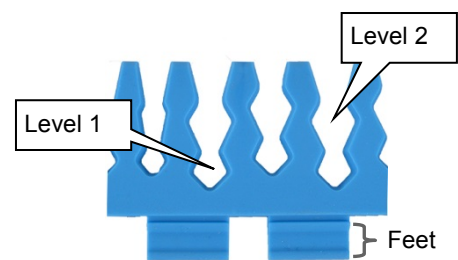

Fig. 27: Detail of the silicone bar

Insert cheek retractors in the MELAstore-Tray 100 so that the grip fits through the niche in the lid with a closed tray.

The MELAstore-Tray 50 and 100 are placed in the insert rack for the MELAstore-Tray 50 and 100.

The MELAstore-Tray 200 is inserted in the insert rack for 3 or 4 MELAstore-Trays/sieve cassettes.

When using the MELAstore-Trays in the insert rack, comply with the information on page 18 ff.

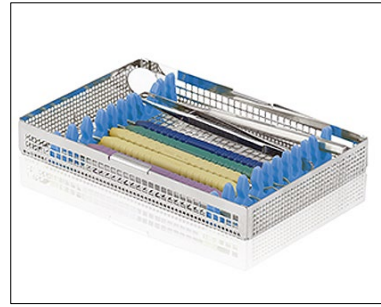

Fig. 28: Loading example

Comply with the following:

- ▶ Remove any (material) residue before performing cleaning and disinfection.
- ▶ Load the MELAstore-Tray correctly for rinsing (e.g. hinged instruments opened, no over loading).
- ▶ Insert large area instruments in such a way as to prevent unwashed areas on other instruments.
- ▶ Do not treat hollow-bodied instrument in MELAstore-Trays.

Used in conjunction with

- Insert rack for MELAstore-Tray 50 and 100, art. no. 80810
- Insert rack for 3 MELAstore-Trays/sieve cassettes, art. no. 00180
- Insert rack for 4 MELAstore- Trays/sieve cassettes, art. no. 80040
- MELAstore-Box 100, art. no. 01191
- MELAstore-Box 200, art. no. 01192
- Holder for identification plate MELAstore-Tray, art. no. 01197

Accessories for interior cleaning

PLEASE NOTE

Check the hoses, connections and instruments for stability both before and after decontamination. Should a hose, connection or an instrument work loose, the instruments must be treated again.

Connectors and adapters for instruments

Injector nozzle

Art. no. 73860



Intended use

The injector nozzles facilitate the decontamination of hollow-bodied instruments e.g. dental surgical aspirator tips etc.

Application

The injector nozzle is screwed on to a connection of the injector rail, the double distributor or the triple distributor (only without a filter disc) and tightened hand-tight with the open-end wrench. The hollow-bodied instruments are placed on the injector rail and fixed with a clamp spring if required.

An appropriate (green) silicone sealing cap is included with the injector nozzle. If the injector nozzle is not fitted with an instrument, it can be sealed quickly and easily with the silicone sealing cap. Further information regarding their application is provided in the chapter [Sealing elements](#) [page 68].

Used in conjunction with

- Silicone seal cap, green (10 pcs.), art. no. 89051
 - Clamp spring for injector nozzle, art. no. 00196
 - Double distributor, art. no. 80200
 - Three-way distributor (without clamp spring), art. no. 73903
-

Clamp spring for injector nozzle

Art. no. 00196



Intended use

The clamp spring facilitates the fixing of light hollow-bodied instruments onto the injector nozzle so that this does not slip through the rinse pressure. It is used exclusively with the injector nozzle.

Application

The clamp spring is pressed together lightly and slid over the injector nozzle.

Used in conjunction with

- Injector nozzle, art. no. 73860

Irrigation sleeve for instruments with Ø 2-11 mm

Art. no. 80260







Intended use

The irrigation sleeve acts as an adapter for the treatment of hollow-bodied instruments with an exterior diameter of 2-11 mm and a non-standardized appendage. The correct insert rings are chosen for this purpose.

Application

The rinse sleeve is screwed onto a connection on the injector rail or is connected with the injector rail via a hose extension and placed in a flex basket. The instrument is inserted in the rinse sleeve shaft side first.

Table 1: Replacement inserts for irrigation sleeve

Qty.	Designation	For instruments with an exterior Ø	Figure	Art. no.
5	Set of insert rings for irrigation sleeve - yellow Ø 2 mm	2-4 mm		80290
5	Set of insert rings for irrigation sleeve - green Ø 4 mm	4-6 mm		80300
5	Set of insert rings for irrigation sleeve - blue Ø 6 mm	6-8 mm		80310
5	Set of insert rings for irrigation sleeve - grey Ø 8 mm	8-10 mm		80320
5	Set of insert rings for irrigation sleeve - red Ø 10 mm	10-11 mm		80330

A rinse sleeve extension is included in the scope of delivery of the rinse sleeve. The rinse sleeve extension serves the decontamination of long hollow-bodied instruments without a defined connection, such as e.g. a fixed endoscope and magnetorestrictive attachments.

Application

The rinse sleeve extension is screwed on between the rinse sleeve and the rinse sleeve shaft. The instrument is pushed into the acceptance of the rinse sleeve extension.



Fig. 29: Rinse sleeve is screwed on



Fig. 30: Inserting the instrument in the socket

! NOTICE

The decontamination of hollow-bodied instruments with an inside diameter of ≤ 0.8 mm requires fine filtration of the liquor. The rinse sleeve may only be operated together with the filter disc housing or the central filter.

When inserting the instrument in the rinse sleeve extension, ensure that the "water inflow" aperture of the hollow-bodied instrument is located in the rinse sleeve extension.

The "water outflow" aperture must be located outside the rinse sleeve extension (see Fig. 31).

Check the rinse sleeve extension regularly for soiling and clean if necessary.

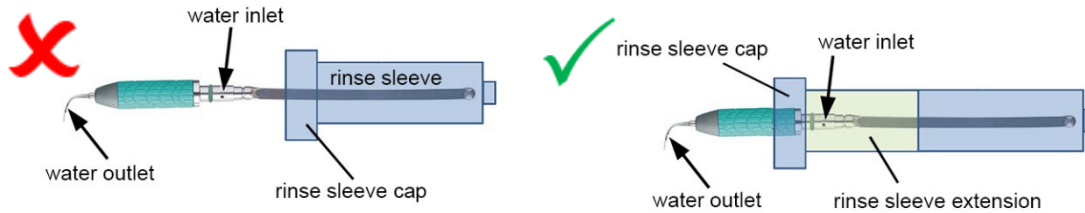

Fig. 31: Rinse sleeve extension using the example of a magnetorestrictive scaling insert

Used in conjunction with

- Filter disc housing (incl. ceramic filter disc), art. no. 73905
- Hose extension with screw connections, art. no. 80195
- Basis basket with injector rail (incl. plastic central filter), art. no. 80440
- Basis basket with injector rail and Cleanfinity filter, art. no. 84610

Adapter (male) for Luer

Art. no. 73880



Intended use

The adapter (male) for Luer facilitates the treatment of instruments/cannulas with a Luer connection (female).

Application

The adapter is screwed on to a connection on the injector rail, the filter disc housing, the double distributor or the triple distributor and tightened hand-tight with the open-end wrench. As the instruments are placed on the adapter and not screwed, they must be checked for stability before and after decontamination.

Used in conjunction with

- Filter disc housing (incl. ceramic filter disc), art. no. 73905
- Double distributor, art. no. 80200
- Triple distributor (incl. ceramic filter disc), art. no. 73903
- Seal (female) for Luer/Luer-Lock, art. no. 80180

Adapter (male) for Luer-Lock

Art. no. 74130



Intended use

The adapter (male) for Luer-Lock facilitates the treatment of instruments/cannulas with a Luer-Lock connection (female).

Application

The adapter is screwed on to a connection on the injector rail, the filter disc housing, the double distributor or the triple distributor and tightened hand-tight with the open-end wrench.

Used in conjunction with

- Filter disc housing (incl. ceramic filter disc), art. no. 73905
- Double distributor, art. no. 80200
- Triple distributor (incl. ceramic filter disc), art. no. 73903
- Adapter (male) for Luer-Lock, art. no. 80170

Adapter (female) for Luer/Luer-Lock

Art. no. 67250



Intended use

The adapter (female) for Luer/Luer-Lock facilitates the treatment of instruments/cannulas with a Luer/Luer-Lock connection (male).

Application

The adapter is screwed on to a connection on the injector rail, the filter disc housing, the double distributor or the triple distributor and tightened hand-tight with the open-end wrench.

Used in conjunction with

- Filter disc housing (incl. ceramic filter disc), art. no. 73905
 - Double distributor, art. no. 80200
 - Triple distributor (incl. ceramic filter disc), art. no. 73903
 - Seal (female) for Luer-Lock, art. no. 80180
-

Adapters for tips

**Adapter for tips
M3.0 x 0.5 mm,
external thread**

Art. no. 80750



Compatible with:

KaVo SONOsoft, PiezoLUX
EMS Piezon Swiss Instruments
W&H Piezo Scaler:
 Tigon, Tigon+, Pyon 2
 Surgery: Piezomed
Komet PiezoLine EM1,
 PiezoLine KA1,
 PiezoLine KA2
NSK Varios EMS
Mectron Multipiezo,
 PiezoSmart, Micropiezo,
 Compact Piezo
Hu-Friedy Piezo E series (EMS)

**Adapter for tips
M3.6xPH1.5 P0.5,
internal thread**

Art. no. 80751



Compatible with:

KaVo SONICflex quick 2008

**Adapter for tips
M3.0 x 0.35 mm,
external thread**

Art. no. 80752



Compatible with:

KaVo PiezoLED, PiezoSoft

**Adapter for tips
M3.0 x 0.6 mm,
external thread**

Art. no. 80756



Compatible with:

Acteon(Satelec) Newtron,
 Suprasson
NSK Varios NSK, Satelec
Hu-Friedy Piezo S series (NSK,
 Satelec, Hu-Friedy)
Ultradent Newtron

**Adapter for tips
M3.5 x 0.6mm,
internal thread**

Art. no. 80760



Compatible with:

Sirona SIROSON, SIROSONIC,
 PerioSonic
Komet PiezoLineSI1
Dürr Vector Scaler

**Adapter for tips
M3.0 x 0.5mm,
internal thread**

Art. no. 80790



Compatible with:

KaVo SONICflex 2000, 2003
Sirona SIROAIR L
W&H air scaler:
 Proxeo, Synea, Alegra
Komet SonicLine:
 Komet SF1LM
W&H air scaler:
 Ti-Max S970, AS2000

Intended use

The adapter serves to clean the interiors of ultrasonic and scaler tips (e.g. ultrasonic scaler tips).

Application

The adapter is screwed onto a connection on the injector basket Flex 1, on the filter disc housing (injector basket without central filter) or directly onto the injector rail with a central filter and tightened hand-tight with the open-end wrench.

Use the torque wrench from the instrument manufacturer to screw the tips on and off. Decontamination with a torque wrench connected is possible, as far as this has been approved by the manufacturer for automatic decontamination. Ensure that you use an adapter with a compatible thread to prevent damage to the instrument.

Comply with the instrument manufacturer's instructions regarding decontamination in a washer-disinfector.

An appropriate white silicon sealing cap is included with the adapter. If the adapter is not fitted with an instrument, it can be sealed quickly and easily with the silicone sealing cap. Further information regarding their application is provided in the chapter [Sealing elements](#) [page 68].

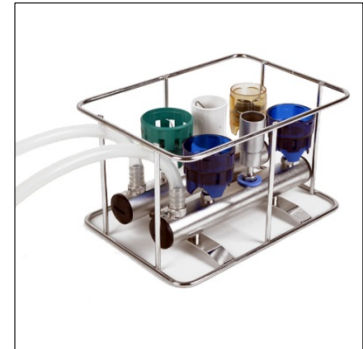

Fig. 32: Connection example

Used in conjunction with

- Silicone sealing cap, green (10 pcs.), art. no. 89051
- Filter disc housing (incl. ceramic filter disc), art. no. 73905
- Basis basket with injector rail (incl. plastic central filter), art. no. 80440
- Basis basket with injector rail and Cleanfinity filter, art. no. 84610
- Injector basket Flex 1, art. no. 80740

Marking discs for adapters for tips

Art. no. 74130

**Intended use**

The marking discs are used to distinguish the adapters for tips. Thus, it can be avoided that instruments are screwed onto the wrong adapters by mistake and that the thread will not get damaged.

Application

The scope of delivery for one set includes 6 green, blue and white marking discs each.

- 1) Screw the adapter for tips from the injector rail.
- 2) Fit the marking disc around the big thread of the adapter.
- 3) Screw the adapter for tips together with the marking disc onto the injector rail.



Fig. 33: Connection example

Used in conjunction with

- Adapter for tips, art. no. 80750, 80751, 80752, 80756, 80760, 80790

Adapters for transfer instruments

- ! NOTICE**
Failure to use a filter can lead to transfer instruments suffering damage!
- Treat the transfer instrument only when a suitable filter is installed.

Selection aid for the use of adapters for transfer instrument

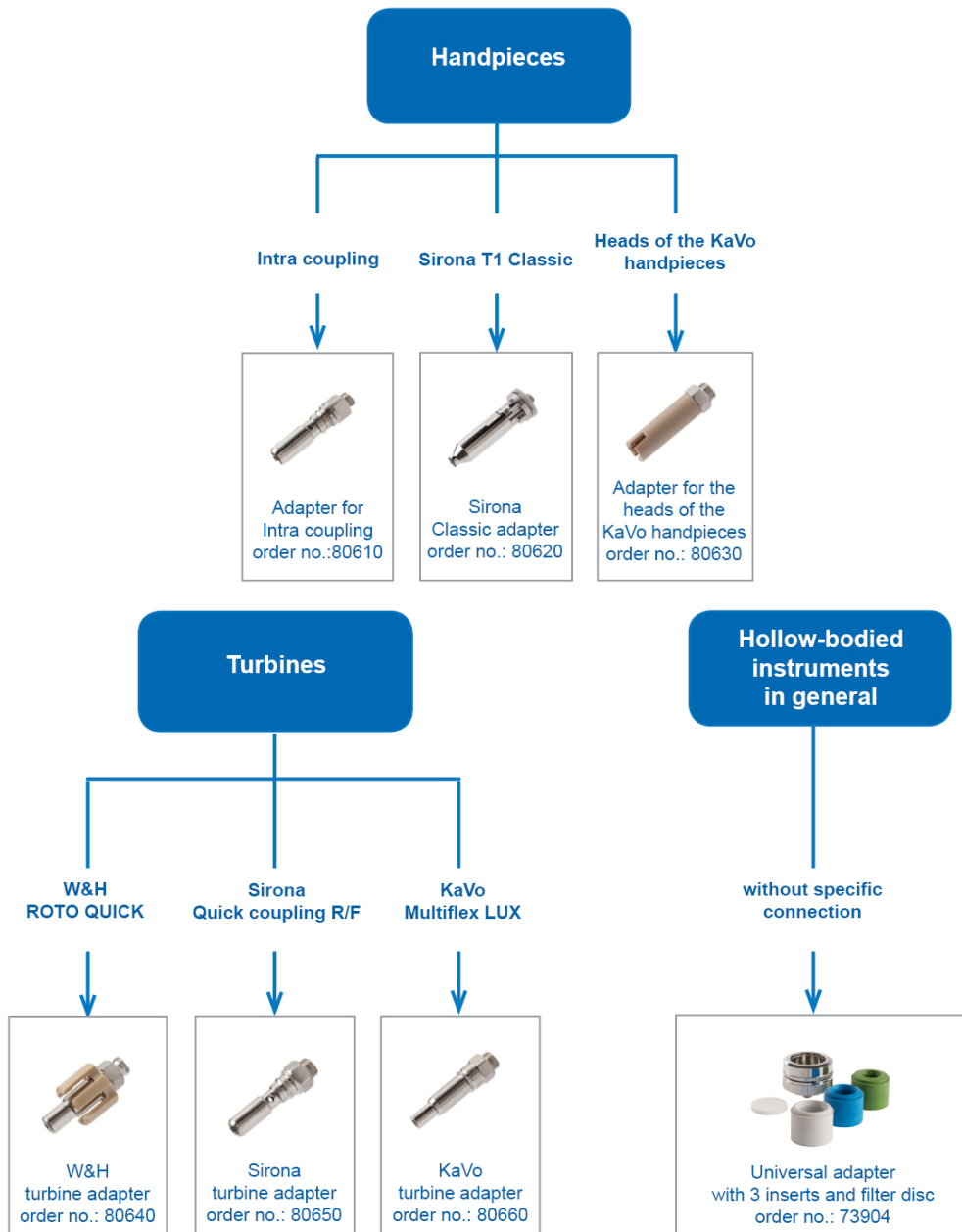

- For example: for preparation of transfer instruments, attachments for the powder blast tool etc.
- Connection is possible with or without filter disc.
- Inserts: green (Ø 16 mm), blue (Ø 20 mm), white (Ø 22 mm).

Adapters for ISO connector (INTRA coupling)

Art. no. 80610



Intended use

The adapter for ISO connector (INTRA coupling) serves the acceptance of mechanically-driven transfer instruments (e.g. handpieces). Handpieces with a short ISO connector (e.g. Sirona T1/T2-Line, W&H Synea Vision Short Edition, NSK nlx nano etc.) can be connected as well.

Application

The adapter is screwed onto a connection on the injector rail with central filter, filter disc housing (injector rail without central filter) and tightened hand-tight with an open-end wrench. The instrument is placed on the adapter until it clicks.

An appropriate white silicon sealing cap is included with the adapter. If the adapter is not fitted with an instrument, it can be sealed quickly and easily with the silicone sealing cap. Further information regarding their application is provided in the chapter [Sealing elements](#) [page 68].

Used in conjunction with

- Silicone sealing cap, white (10 pcs.), art. no. 89071
- Filter disc housing (incl. ceramic filter disc), art. no. 73905
- Basis basket with injector rail (incl. plastic central filter), art. no. 80440
- Basis basket with injector rail and Cleanfinity filter, art. no. 84610

Adapter for KaVo turbines (MULTiflex connection)

Art. no. 80660



Intended use

The adapter for KaVo turbines serves the acceptance of instruments with a MULTiflex connection.

Application

The adapter is screwed onto a connection on the injector rail with central filter, filter disc housing (injector rail without central filter) and tightened hand-tight with an open-end wrench. The instrument is placed on the adapter until it clicks.

An appropriate blue silicon sealing cap is included with the adapter. If the adapter is not fitted with an instrument, it can be sealed quickly and easily with the silicone sealing cap. Further information regarding their application is provided in the chapter [Sealing elements](#) [page 68].

Used in conjunction with

- Silicone sealing cap, blue (10 pcs.), art. no. 89061
- Filter disc housing (incl. ceramic filter disc), art. no. 73905
- Basis basket with injector rail (incl. plastic central filter), art. no. 80440
- Basis basket with injector rail and Cleanfinity filter, art. no. 84610

Adapter for the heads of the KaVo handpieces

Art. no. 80630

**Intended use**

This adapter serves the acceptance of removable KaVo handpiece heads.

Application

The adapter is screwed onto a connection on the injector rail with central filter, a triple distributor or a single filter housing (injector rail without central filter) and tightened hand-tight with an open-end wrench. The instrument is placed on the adapter until it clicks.

An appropriate white silicon sealing cap is included with the adapter. If the adapter is not fitted with an instrument, it can be sealed quickly and easily with the silicone sealing cap. Further information regarding their application is provided in the chapter [Sealing elements](#).

Used in conjunction with

- Silicone sealing cap, white (10 Stück), art. no. 89071
- Filter disc housing, art. no. 73905
- Basis basket with injector rail (incl. plastic central filter), art. no. 80440
- Basis basket with injector rail and Cleanfinity filter, art. no. 84610
- Triple distributor (incl. ceramic filter disc), art. no. 73903

Adapter for Sirona Classic

Art. no. 80620

**Intended use**

The adapter serves the acceptance of handpieces of Sirona Classic series.

Application

The adapter is screwed onto a connection on the injector rail with central filter, filter disc housing (injector rail without central filter) and tightened hand-tight with an open-end wrench. The instrument is placed on the adapter until it clicks.

An appropriate blue silicon sealing cap is included with the adapter. If the adapter is not fitted with an instrument, it can be sealed quickly and easily with the silicone sealing cap. Further information regarding their application is provided in the chapter [Sealing elements](#).

Used in conjunction with

- Silicone sealing cap, blue (10 pcs.), art. no. 89061
- Filter disc housing (incl. ceramic filter disc), art. no. 73905
- Basis basket with injector rail (incl. plastic central filter), art. no. 80440
- Basis basket with injector rail and Cleanfinity filter, art. no. 84610

Adapter for Sirona turbines

Art. no. 80650

**Intended use**

The adapter for Sirona turbines serves the acceptance of Sirona turbines.

Application

The adapter is screwed onto a connection on the injector rail with central filter, filter disc housing (injector rail without central filter) and tightened hand-tight with an open-end wrench. The instrument is placed on the adapter until it clicks.

An appropriate blue silicon sealing cap is included with the adapter. If the adapter is not fitted with an instrument, it can be sealed quickly and easily with the silicone sealing cap. Further information regarding their application is provided in the chapter [Sealing elements](#).

Used in conjunction with

- Silicone sealing cap, blue (10 pcs.), art. no. 89061
 - Filter disc housing (incl. ceramic filter disc), art. no. 73905
 - Basis basket with injector rail (incl. plastic central filter), art. no. 80440
 - Basis basket with injector rail and Cleanfinity filter, art. no. 84610
-

W&H turbine adapter

Art. no. 80640



Intended use

The W&H turbine adapter serves the acceptance of W&H turbines.

Application

The adapter is screwed onto a connection on the injector rail with central filter, filter disc housing (injector rail without central filter) and tightened hand-tight with an open-end wrench. The instrument is placed on the adapter until it clicks.

An appropriate blue silicon sealing cap is included with the adapter. If the adapter is not fitted with an instrument, it can be sealed quickly and easily with the silicone sealing cap. Further information regarding their application is provided in the chapter [Sealing elements](#).

Used in conjunction with

- Silicone sealing cap, blue (10 pcs.), art. no. 89061
- Filter disc housing (incl. ceramic filter disc), art. no. 73905
- Basis basket with injector rail (incl. plastic central filter), art. no. 80440
- Basis basket with injector rail and Cleanfinity filter, art. no. 84610

Filter disc housing with ceramic filter disc

Art. no. 73905



Intended use

The filter disc housing serves the filtration of a single connection on the injector rail, as long as no central filter is used on the injector rail. Both the re-usable metal filter disc (art. no. 80350) and the ceramic filter disc (art. no. 64375) can be used.

! NOTICE

The decontamination of hollow-bodied instruments with an inside diameter of ≤ 0.8 mm requires a fine filter of the liquor.

Application

All available adapters can be screwed onto the filter disc housing. Use of the Flex 1 injector basket and the injector rail without a central filter requires two filter disc housings to connect both connection hoses. The filter disc housing is screwed onto a connection on the injector rail and tightened hand-tight.



WARNING

An incorrectly sealed filter housing or connection on the injector rail can hamper filtration.

The cleaning performance is reduced, producing the danger of contamination.

- Always check that the filter housing is sealed fully and is connected correctly to the injector rail.

Description for inserting / replacing the filter disc

Change the filter disc in regular intervals. See the section [Filter inserts](#) [p. 63].

- 1) Insert the filter disc in the yellow silicone insert.
- 2) Insert the yellow silicone insert in the lower section of the filter disc housing with the filter disc pointing downwards.
- 3) Place the upper section of the filter disc housing on the lower section and turn the bayonet cap to its fullest extent (the markings lie over each other).

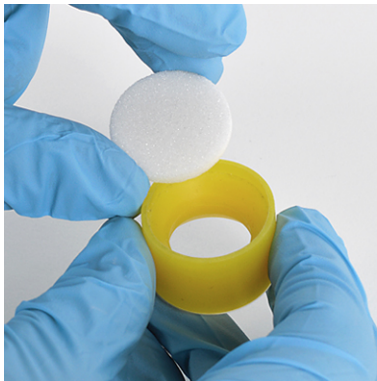

Step 1

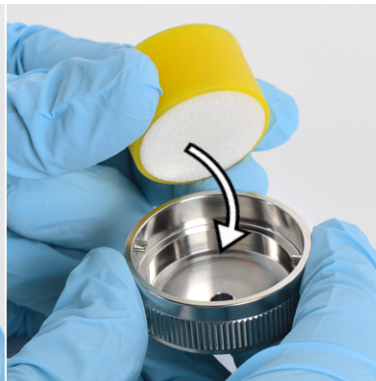

Step 2

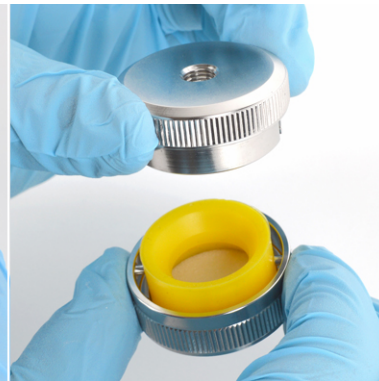

Step 3

When using re-usable metal filter discs, comply with the following:

- ▶ Rinse the reusable metal filter disc under running water before initial use.
- ▶ Always insert the silicone insert in the filter disc housing with the reusable metal filter disc with the printed side facing downwards.

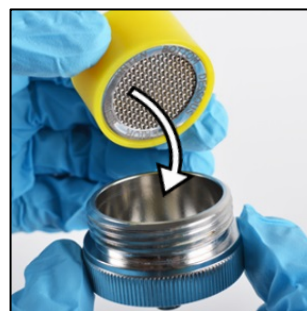
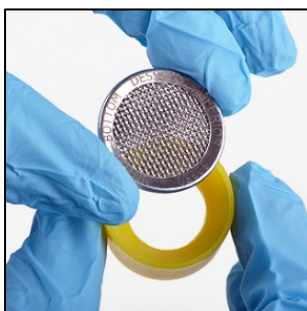

NOTICE

Do not combine the filter disc housing with other filter elements.

- The filter disc housing may only be connected to the injector rail without a central filter.

Used in conjunction with

- Adapter for ISO connector (INTRA-coupling), art. no. 80610
- Adapter for Sirona Classic, art. no. 80620
- Adapter for the heads of the KaVo handpieces, art. no. 80630
- Adapter for W&H turbines, art. no. 80640
- Adapter for Sirona turbines, art. no. 80650
- Adapter for KaVo turbines (MULTIflex connection), art. no. 80660
- Adapter (male) for Luer, art. no. 73880
- Adapter (male) for Luer-Lock, art. no. 74130
- Adapter (female) for Luer/Luer-Lock, art. no. 67250
- Adapter for tips, art. no. 80750, 80751, 80752, 80756, 80760, 80790
- Irrigation sleeve for instruments with exterior Ø 2-11 mm, art. no. 80260
- Ceramic filter disc (10 pcs.), art. no. 64375
- Metal filter disc, art. no. 80350
- Connection for hoses with interior Ø 6 mm, external thread, art. no. 80150
- Hose extension with screw connections, art. no. 80195
- Basis basket with injector rail (incl. 11 blind screws), art. no. 00200
- Basket with injector rail (incl. 11 nozzles and clamp springs), art. no. 00197

Universal adapter (incl. 3 inserts and ceramic filter disc)

Art. no. 73904

**Intended use**

The universal adapter serves the acceptance of hollow-bodied instruments without a defined connection (e.g. attachments for the powder jet unit)

The universal adapter can accommodate a filter disc. Take this into account when decontaminating instruments with an inside diameter ≤ 0.8 mm. Both the re-usable metal filter disc (art. no. 80350) and the ceramic filter disc (art. no. 64375) can be used.

Application

The hollow-bodied instruments are placed in the universal adapter with their shaft pointing downwards. Select the silicone insert in accordance with the external diameter of the hollow-bodied instruments to be decontaminated and insert them in the universal adapter.

**NOTICE**

Do not combine multiple filter elements.

- When using the injector rail with a central filter, remove the filter disc from the universal adapter.

When using filter elements, comply with the following:

- ▶ Hollow-bodied instruments with an interior diameter ≤ 0.8 mm require filter elements.
- ▶ When using the Basis basket with injector rail (incl. 2 central filters), the filter disc must be removed from the universal adapter.
- ▶ Comply with the regular replacement intervals for the filter inserts (see [Filter inserts](#) [p. 63]).

Table 2: Silicone inserts for universal adapter

Qty.	Silicone insert	Figure	Art. no.
1	green, Ø 16 mm		63500
1	blue, Ø 20 mm		63501
1	white, Ø 22 mm		63502

When using distance sleeve (art. no. 55120) multiple universal adapters can be screwed onto the injector rail next to each other.

- Up to 11 Universal adapters and a distance sleeve fit on the injector rail **without** a central filter.
- Up to 9 Universal adapters and a distance sleeve fit on the injector rail **with** a central filter.



Changing the filter

- 1) Insert the filter disc in the green, blue or white silicone insert.
- 2) Insert the green, blue or white silicone insert in the lower section of the universal adapter with the filter disc pointing downwards.
- 3) Place the upper section of the universal adapter on the lower section and screw them together hand tight.



Step 1

Step 2

Step 3

When using re-usable metal filter discs, comply with the following:

Rinse the reusable metal filter disc under running water before initial use. Always insert the silicone insert with the re-usable metal filter disc with the printed side facing downwards.

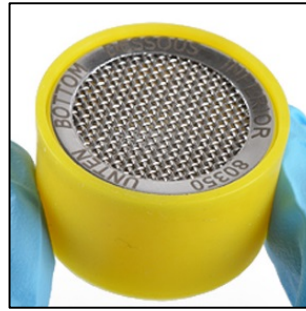
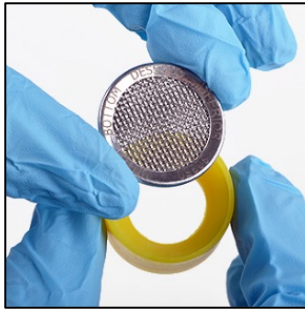
**Used in conjunction with**

- Basis basket with injector rail (incl. 11 blind screws), art. no. 00200
- Basket with injector rail (incl. 11 nozzles and clamp springs) art. no. 00197
- Basis basket with injector rail (incl. plastic central filter), art. no. 80440
- Basis basket with injector rail and Cleanfinity filter, art. no. 84610
- Ceramic filter disc (10 pcs.), art. no. 64375
- Metal filter disc, art. no. 80350
- Distance sleeve, art. no. 55120
- Silicone insert for Universal adapter (green), Ø 16 mm, art. no. 63500
- Silicone insert for Universal adapter (blue), Ø 20 mm, art. no. 63501
- Silicone insert for Universal adapter (white), Ø 22 mm, art. no. 63502

Distance sleeve

Art. no. 55120

**Intended use**

The distance sleeve serves the maximum use of the injector rail when using the filter disc housing, universal adapter or triple distributor.

Application

The distance sleeve is screwed onto a connection on the injector rail and tightened hand-tight with the open-end wrench. The adapter required is screwed onto the distance sleeve.

- Up to 11 universal adapters and a distance sleeve fit on the injector rail **without** a central filter.
- Up to 9 universal adapters and a distance sleeve fit on the injector rail **with** a central filter.

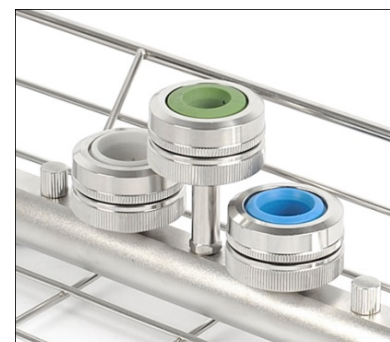

Fig. 34: Spacer collar on the injector rail

Used in conjunction with

- Universal adapter (incl. 3 inserts and filter disc), art. no. 73904
- Filter disc housing (incl. ceramic filter disc), art. no. 73905
- Triple distributor (incl. ceramic filter disc), art. no. 73903

Adapter for exterior spray channels

Art. no. 74135

**Intended use**

The adapter serves the rinsing of exterior (spray) channels in transfer instruments and other non-standardized hollow-bodied instruments with small external diameter.

Application

The adapter for external spray channels is screwed onto a connection of the injector rail with central filter, a double distributor, triple distributor or a filter disc housing (injector rail without central filter) and tightened hand-tight with an open-end wrench. The free end of the silicone hose is placed on the end of the (spray) channel which is to be rinsed.

Please ensure that the silicon hose is connected to the input side of the spray channel i.e. in the direction of flow.

To this end, the silicon hose included in the scope of delivery is cut to size so that the silicon hose remains taugt (avoiding loops) but is not too taugt, see the application example.



Fig. 35: The adapter is connected with the transfer instrument to be rinsed

**WARNING**

Loosely attached silicon hoses can slip from the channels during the program run.

- Check the instruments after the program run to verify the position of the silicon hose.
- If silicon hoses have slipped off, the instrument concerned must be treated again.

Used in conjunction with

- Double distributor, art. no. 80200
- Triple distributor (incl. ceramic filter disc), art. no. 73903
- Filter disc housing (incl. ceramic filter disc), art. no. 73905
- Basis basket with injector rail (incl. plastic central filter), art. no. 80440
- Basis basket with injector rail and Cleanfinity filter, art. no. 84610

Double distributor

Art. no. 80200



Intended use

The double distributor extends the connections of the injector rail and can be fitted with various adapters (e.g. injector rail, hose connection, an adapter for Luer-/Luer-Lock etc.).

Application

The double distributor is screwed onto a connection on the injector rail. Further adapters such as an injector nozzles or connections for the Luer-/Luer-Lock- and/or hoses are screwed onto the double distributor. Both connections must be occupied all the time to ensure correct function. Seal non-used connections with a sealing screw (art. no. 80140).

The double distributor cannot accommodate a filter disc. Take this into account when decontaminating instruments with an inside diameter ≤ 0.8 mm.

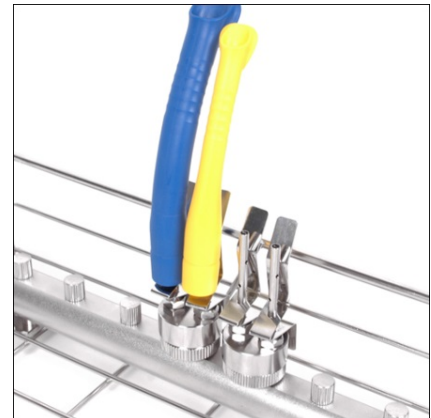

Fig. 36: Example

! NOTICE

The double distributor extends the connections of the injector rail. It may not be combined with further multi-way distributors.

! NOTICE

Failure to cover all the apertures on the double distributor can impair the cleaning result.

- Always place instruments on the adapter. If possible, seal non-used adapters with the suitable silicone sealing cap.
- Seal the unused connections on the double distributor with sealing screws (art. no. 80140).

Used in conjunction with

- Injector nozzle, art. no. 73860
- Clamp spring for injector nozzle, art. no. 00196
- Adapter (male) for Luer, art. no. 73880
- Adapter (male) for Luer-Lock, art. no. 74130
- Adapter (female) for Luer/Luer-Lock, art. no. 67250
- Sealing screw for the injector rail and double/triple distributor, art. no. 80140
- Connection for hoses with interior \varnothing 6 mm, external thread, art. no. 80150
- Hose extension with screw connections, art. no. 80195

Triple distributor (incl. ceramic filter disc)

Art. no. 73903



Intended use

The triple distributor extends the connections of the injector rail and can be fitted with various adapters (e.g. injector nozzles, hose connections, adapters for Luer-/Luer-Lock etc.).

The triple distributor can accommodate a filter disc. Take this into account when decontaminating instruments with an inside diameter ≤ 0.8 mm. Both the re-usable metal filter disc (art. no. 80350) and the ceramic filter disc (art. no. 64375) can be used.

Application

The triple distributor is screwed onto a connection on the injector rail. Further adapters such as injector nozzles or connections for the Luer-/Luer-Lock- and/or hoses are screwed onto the triple distributor. All connections must be filled all the time to ensure correct function. Seal non-used connections with a sealing screw (art. no. 80140).

The use of filter inserts is necessary with hollow-bodied instruments with an interior diameter ≤ 0.8 mm. Comply with the regular replacement intervals for the filter inserts (see [Filter inserts](#) [page 63]).

The use of filter discs is necessary with hollow-bodied instruments with an interior diameter ≤ 0.8 mm.



NOTICE

Do not combine multiple filter elements.

- When using the injector rail with a central filter, remove the filter disc from the triple distributor.
-



NOTICE

The triple distributor extends the connections of the injector rail. It may not be combined with further multi-way distributors.



NOTICE

Failure to cover all the connections on the triple distributor can impair the cleaning result.

- Always place instruments on the adapter. If possible, seal non-used adapters with the suitable silicone sealing cap.
 - Seal the unused connections on the triple distributor with sealing screws (art. no. 80140).
-

Changing the filter

- 1) Insert the filter disc in the yellow silicone insert. The printed side must point upwards.
- 2) Insert the silicone insert with the reusable metal filter disc in the lower section of the triple distributor housing.
- 3) Place the distributor plate on the yellow silicone insert.
- 4) Place the upper section of the triple distributor housing on the distributor plate and the lower section of the housing. Tighten the sections hand-tight.

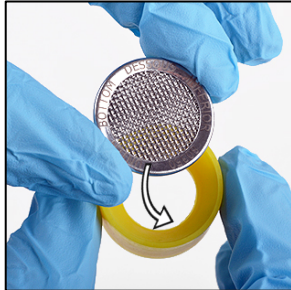

Step 1

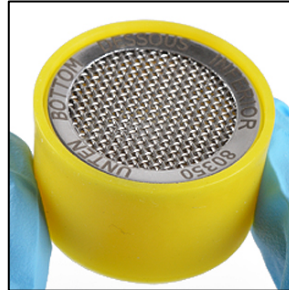

Step 2



Step 3

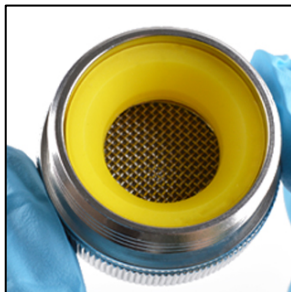

Step 4



Step 5



Step 6

When using re-usable metal filter disc, comply with the following:

Rinse the reusable metal filter disc under running water before initial use. Always insert the silicone insert with the re-usable metal filter disc with the printed side facing downwards.

Used in conjunction with

- Adapter (male) for Luer, art. no. 73880
- Adapter (male) for Luer-Lock, art. no. 74130
- Adapter (female) for Luer/Luer-Lock, art. no. 67250
- Sealing screw, art. no. 80140
- Ceramic filter disc (10 pcs.), art. no. 64375
- Metal filter disc, art. no. 80350
- Connection for hoses with interior Ø 6 mm, external thread, art. no. 80150
- Hose extension with screw connections, art. no. 80195
- Basis basket with injector rail (incl. plastic central filter), art. no. 80440
- Basis basket with injector rail and Cleanfinity filter, art. no. 84610
- Basis basket with injector rail (incl. 11 blind screws), art. no. 00200
- Basket with injector rail (incl. 11 nozzles and clamp springs), art. no. 00197

Filter inserts



PLEASE NOTE

No additional filter elements may be used when using the basis basket with injector rails and central filter.

Ceramic filter disc (10 pcs.)

Art. no. 64375



Intended use

Hollow-bodied instruments with an interior diameter ≤ 0.8 mm require filter elements.

The ceramic filter disc can be used in the filter disc housing, the triple distributor or the universal adapter.

The ceramic filter disc is not suitable for re-use and must be disposed of correctly after the replacement interval.

Application

When using the ceramic filter disc, comply with the regular replacement intervals.

The ceramic filter disc in the adaptors should be changed approx. every two weeks or after every 20 cycles at the latest, as they accrete dirt particles after a while. Please ensure that you count the cycles in which no instruments have been placed on the adaptor.

Rinse a new filter disc under running water before inserting. The adaptor should be freed of any dirt particles, preferably using compressed air.

Used in conjunction with

- Universal adapter (incl. 3 inserts and ceramic filter disc), art. no. 73904
 - Filter disc housing (incl. ceramic filter disc), art. no. 73905
 - Triple distributor (incl. ceramic filter disc), art. no. 73903
-

Metal filter disc

Art. no. 80350



Intended use

Hollow-bodied instruments with an interior diameter ≤ 0.8 mm require filter elements.

The re-usable metal filter disc can be used in the filter disc housing, the triple distributor or the universal adapter.

The re-usable metal filter disc is not suitable for re-use and must be disposed of correctly after the replacement interval.

Rinse a new metal filter disc under running water before inserting. The adaptor should be freed of any dirt particles, preferably using compressed air.

The re-usable metal filter disc should be changed approx. every two weeks or after every 20 cycles at the latest, as they accrete dirt particles after a while. Please ensure that you count the cycles in which no instruments have been placed on the adaptor. The re-usable metal filter disc can be cleaned a total of 20 times.

Proceed as follows to clean:

1. Remove coarse dirt particles with a plastic brush whilst under cold running water.
2. Then clean the reusable metal filter disc in an ultrasonic device at 50 °C for c. 30 min. and with an acid cleaner e.g. 35 ml/l Dr. Weigert neodisher IR in de-ionized water (DI-water). Comply with the manufacturer's specifications for the ultrasonic device.
3. Rinse the reusable metal filter disc under cold running water.
4. If the reusable metal filter disc is not used directly, it must be dried and then stored in a dry location.



NOTICE

Never use a soiled or damaged metal filter disc.



NOTICE

In rare cases, dirt particles can remain on the reusable metal filter disc after ultrasonic cleaning and can work loose during decontamination.

- Do not use the reusable metal filter disc in the ophthalmic area.
 - Instead, use the ceramic filter disc (art. no. 64375).
-

Used in conjunction with

- Universal adapter (incl. 3 inserts and ceramic filter disc), art. no. 73904
 - Filter disc housing (incl. ceramic filter disc), art. no. 73905
 - Triple distributor (incl. ceramic filter disc), art. no. 73903
-

Plastic central filterl

Art. no. 80490



Intended use

The plastic central filter serves the fine filtration of the rinse liquor in the injector rail.

Application

The plastic central filter may only be operated with the injector rail for the central filter. Application advice for the injector rail and plastic central filter is available on page 13.



NOTICE

Hollow-bodied instruments with an interior diameter ≤ 0.8 mm require filter inserts.



PLEASE NOTE

No additional filter elements such as ceramic and metal filter discs may be used when using the basis basket with injector rail (inc. Cleanfinity filter / plastic central filter).

Universal adapter and triple distributors are equipped with filter discs upon delivery.

- Before using a basis basket with injector rail (inc. Cleanfinity filter / plastic central filter), remove the filter elements already provided.
-

Comply with the following information:

- ▶ The expiry date given on the packaging of the plastic central filter may not be exceeded.
- ▶ Place the plastic central filter on the injector rail before the storage date has expired.
- ▶ The plastic central filter may only be stored in unopened original packaging.
- ▶ The plastic central filter may not permanently be exposed to UV light.

Used in conjunction with

- Basis basket with injector rail (incl. plastic central filter), art. no. 80440
 - Basis basket with injector rail and Cleanfinity filter, art. no. 84610
-

Cleanfinity filter (inc. cleaning brush)

Art. no. 84630



Intended use

The Cleanfinity filter is a cleanable central filter and serves the fine filtration of the rinse liquor of the corresponding injector rail.

Application

The Cleanfinity filter may only be operated in combination with the injector rail for the central filter. Application usage advice for the injector rail and the Cleanfinity filter is found on page 13.



NOTICE

Hollow-bodied instruments with an interior diameter ≤ 0.8 mm require filter inserts.



PLEASE NOTE

No additional filter elements such as ceramic and metal filter discs may be used when using the basis basket with injector rail (inc. Cleanfinity filter / plastic central filter).

Universal adapter and triple distributors are equipped with filter discs upon delivery.

- Before using a basis basket with injector rail (inc. Cleanfinity filter / plastic central filter), remove the filter elements already provided.

Used in conjunction with

- Basis basket with injector rail and Cleanfinity filter, art. no. 84610

Cleaning

Before cleaning the Cleanfinity filter, make sure that the sealing cap on the end of the filter is open.

Comply with the following specifications:

- ▶ Decontaminate the Cleanfinity filter in accordance with the cleaning instructions immediately before inserting it.
- ▶ Only use the original cleaning brush (art. no. 84640). Check the cleaning brush for damage before cleaning. If necessary, dispose of and replace the cleaning brush.
- ▶ The cleaning brush must not be taken into the clean room.
- ▶ Wear gloves, a mask and protective goggles when performing the cleaning.

Proceed as follows to clean:

1. Turn the bayonet lock of the sealing cap anti-clockwise until the stop (Fig. 37, pos. a). Remove the sealing element from the Cleanfinity filter.

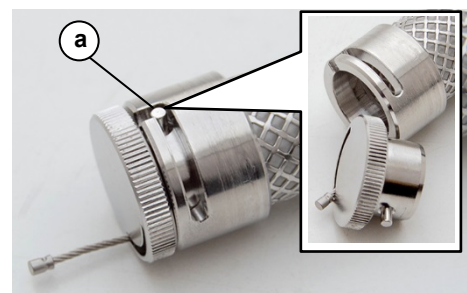

Fig. 37: Cleanfinity filter opened

2. Clean the Cleanfinity filter lengthways under running water (Fig. 38).
At the same time, slide the cleaning brush through the filter (grip side first) to its fullest extent and pull it out.
Repeat this procedure at least three times, until the central filter is visibly clean.
3. Stubborn soiling can be removed with a compressed air gun or a MELAjet spray gun.



Fig. 38: Cleaning the Cleanfinity filter

4. Re-apply the sealing cap of the Cleanfinity filter.
Slide the sealing cap (Fig. 40, pos. b) into the filter to its fullest extent and close the bayonet lock by turning it clockwise. Make sure that the bayonet lock is positioned and locked correctly (Fig. 40, pos. c).



Fig. 39: Bayonet lock in opened Position

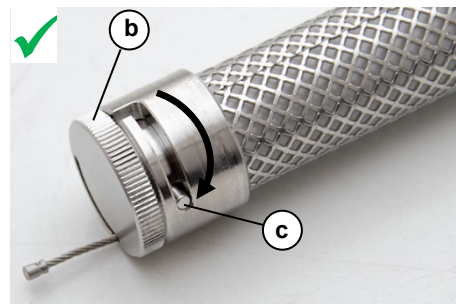

Fig. 40: Bayonet lock in locked position

Sealing elements



NOTICE

● Failure to cover all the connections on the connections or the injector rail can impair the cleaning result.

- Always place instruments on the adapter. If possible, seal non-used adapters with the suitable silicone sealing cap.
 - Seal the unused connections with sealing screws (art. no. 80140).
-

Silicone sealing cap, green (10 pcs.)

Art. no. 89051



Intended use

If an instrument is not fitted to the adapter, the adapter can be sealed quickly and easily with the silicone sealing cap.

Application

Slide the silicone cap as far onto the adapter until it is tight. To enable easy removal, do not slide on the silicone sealing cap to the fullest extent. Sliding the seal cap on and off in a dry state can be difficult.

Used in conjunction with

- Injector nozzle, art. no. 73860
 - Adapter for tips, art. no. 80750, 80751, 80752, 80756, 80760, 80790
-

Silicone sealing cap, blue (10 pcs.)

Art. no. 89061



Intended use

If an instrument is not fitted to the adapter, the adapter can be sealed quickly and easily with the silicone sealing cap.

Application

Slide the silicone cap as far onto the adapter until it is tight. To enable easy removal, do not slide on the silicone sealing cap to the fullest extent. Sliding the seal cap on and off in a dry state can be difficult.

Used in conjunction with

- Connection for hoses with interior Ø 6mm, external thread, art. no. 80150
- Adapter for Sirona Classic, art. no. 80620
- Adapter for W&H turbines, art. no. 80640
- Adapter for Sirona Classic, art. no. 80650
- Adapter for KaVo turbines (MULTIflex connection), art. no. 80660

White silicone sealing cap (10 pcs.)

Art. no. 89071



Intended use

If an instrument is not fitted to the adapter, the adapter can be sealed quickly and easily with the silicone sealing cap.

Application

Slide the silicone cap as far onto the adapter until it is tight. To enable easy removal, do not slide on the silicone sealing cap to the fullest extent. Sliding the seal cap on and off in a dry state can be difficult.

Used in conjunction with

- Adapter for ISO connector (INTRA coupling), art. no. 80610
 - Adapter for the heads of the KaVo handpieces, art. no. 80630
-

Sealing screw for injector rail and distributor

Art. no. 80140



Intended use

The sealing screw is used to seal non-required connections on the injector rail or the distributors.

Application

The sealing screw is screwed into a non-used connection.

Seal (male) for Luer-Lock

Art. no. 80170



Intended use

The seal (male) for Luer-Lock is used to seal an adapter for Luer-Lock (female).

Application

In order to seal an adapter for Luer-Lock (e.g. when not used) the seal is simply screwed in to prevent a decrease in the cleaning pressure.

Used in conjunction with

- Adapter (female) for Luer/Luer-Lock, art. no. 67250
-

Seal (female) for Luer/Luer-Lock

Art. no. 80180

***Intended use***

The seal for Luer/Luer-Lock (female) is used to seal an adapter for Luer-Lock (male).

Application

In order to seal an adapter for Luer-Lock (e.g. when not used) the seal is simply screwed in to prevent a decrease in the cleaning pressure.

Used in conjunction with

- Adapter (male) for Luer, art. no. 73880
- Adapter (male) for Luer-Lock, art. no. 74130

Hoses and hose connections

Please comply with the following instructions before installing the hoses:

- ▶ Hoses must be installed without kinks and sagging.
- ▶ The hoses must be kept as short as possible.
- ▶ The hoses may not be locked.
- ▶ Check the hoses, connections and instruments for stability both before and after treatment. Should a hose, connection or an instrument work loose, the instruments must be treated again.

Connection for hoses with interior Ø 6 mm, external thread

Art. no. 80150



Intended use

The hose connection connects hoses with a 6 mm interior diameter either with the injector rail or the triple distributor.

Application

The hose connection is screwed onto a connection of the injector rail, the filter disc housing or a distributor. The hose connection must always be connected to ensure functionality. Seal non-used hose connections with a sealing screw (art. no. 80140).

An appropriate blue silicone sealing cap is included with the adapter. If the adapter is not fitted with an instrument, it can be sealed quickly and easily with the silicone sealing cap. Further information regarding their application is provided in the chapter [Sealing elements](#) [page 68].

Used in conjunction with

- Silicone sealing cap, blue (10 pcs.), art. no. 89061
- Silicon hose, Ø 10/6 mm, running metre, art. no. 80190
- Filter disc housing (incl. ceramic filter disc), art. no. 73905
- Double distributor, art. no. 80200
- Triple distributor (incl. ceramic filter disc), art. no. 73903

Connection for hoses with interior Ø 6mm, internal thread

Art. no. 80160



Intended use

The hose connection with internal thread enables the extension of the injector rail connection via a Ø 6 mm hose, e.g. if very long hollow bodied instruments are to be decontaminated, which only fit lying down in a flex basket.

Application

The hose connection is placed onto the free end of the hose. All other adapters can be connected to the internal thread.

Used in conjunction with

- Silicon hose, Ø 10/6 mm, running metre, art. no. 80190

Silicon hose Ø 10/6 mm, running metre

Art. no. 80190



Intended use

The silicone hose is used to connect instruments to connections or to move connections on the injector rail. Instruments with a hose connection can also be pressed into the hose.

Application

Long hoses must be removed when not used otherwise water can collect inside. The hose can be cut to the required length. Avoid unnecessarily long hoses.

Used in conjunction with

- Connection for hoses with interior Ø 6 mm, external thread, art. no. 80150
- Connection for hoses with interior Ø 6 mm, internal thread, art. no. 80160

Hose extension with screw connections

Art. no. 80195



Intended use

The hose extension enables connections on the injector rail to be moved, e.g. if very long hollow bodied instruments are to be decontaminated which only fit lying down in a flex basket.

Application

Delivery is performed in lengths of 50 cm, each with a hose connection with an interior and external thread. Long hoses must be removed when not used otherwise water can collect inside. The hose can be cut to the required length. Avoid unnecessarily long hoses.

Used in conjunction with

- Flex basket 6, art. no. 80255
 - Filter disc housing (incl. ceramic filter disc), art. no. 73905
 - Irrigation sleeve for instruments with exterior Ø 2-11 mm, art. no. 80260
 - Double distributor, art. no. 80200
 - Triple distributor (incl. ceramic filter disc), art. no. 73903
-

Examples for basic configurations

Basic configuration for the ENT practice



Basis basket with injector rail (incl. 11 blind screws), art. no. 00200 | Flex basket 2, art. no. 80020 | Flex basket 3, art. no. 80030 | Instrument basket compact, art. no. 00195 | Ear specula attachment Flex 2, art. no. 80090 | Top frame for nasal specula (incl. 2 fixing clamps), art. no. 80435

Basic configuration for the gynaecological practice



Basis basket without injector rail, art. no. 00188 | Flex basket 6, art. no. 80255 | Flex basket specula, art. no. 80410.

Basic configuration for the dental practice



Basis basket with injector rail (incl. 11 nozzles and clamp springs), art. no. 00197 | Insert rack for 3 MELAstore-Trays/sieve cassettes, art. no. 00180 | MELAstore Tray 100, art. no. 01181 | Flex basket 2, art. no. 80020 | Insert rack for scissors, impression trays, and clamps, art. no. 80110 | Insert rack for hinged and jointed instruments, art. no. 80120 | Instrument basket standard, art. no. 00184 | Small parts container, art. no. 00133

Basic configuration for the OMF surgery



Basis basket with injector rail (incl. 11 blind screws), art. no. 00200 | Flex basket 6, art. no. 80255 | Flex basket 3, art. no. 80030

MELAG Medizintechnik oHG

Geneststraße 6-10
10829 Berlin
Germany

Email: info@melag.com

Web: www.melag.com

Responsible for content: MELAG Medizintechnik oHG

We reserve the right to technical alterations

Your stockist:

