



OPERATING MANUAL FOR CABINETS, COUNTERS, PREPARATION STATIONS, BACK BAR & SMARTSTORE

IMPORTANT INFORMATION (PLEASE RETAIN THIS DOCUMENT)

This Manual covers the installation, operation and routine maintenance requirements for the following Williams Refrigeration products:

Garnet / Sapphire / Crystal / Jade / Zircon / Opal / Emerald / Biscuit Top / Aztra / Amber / Under Broiler Counter / Onyx / Salad Units / Thermowell / Bottle Coolers / Bottle Well / SmartStore / Roll-in Ruby Models / Mobile Refrigerated

Please read this Manual carefully before connecting the appliance.

Provided the instructions in this Operating Manual are read and implemented correctly, the optimum performance and reliability of your equipment should be maintained.

We assume the installer, user and service provider are appropriately trained, skilled and competent to properly and safely carry out the work, and will use the necessary safety equipment, and take the necessary precautions required of their intended work.

Williams cabinets/counters are available in a choice of temperature ranges and specific ambient ratings.

Temperature parameters are set as follows:

General Produce (H)	+1°C(34°F) / +4°C (39°F)	Thermowell	+4°C(39°F) / +8°C(47°F)
Bottle Coolers / Bottle Wells	+4°C(39°F) / +10°C(50°F)	Meat/Fish (M/F)	+2°C (36°F)/ -2°C (28°F)
Frozen Produce (L)	-18°C (0°F)/ -22°C (-8°F)	Retarder Prover: Retard	-5°C(23°F) / +3°C(37°F)
Chilled Food (CF)	0°C (32°F)/ +3°C (37°F)	Retarder Prover: Prove	+38°C(100°F) / +40°C(104°F)
Wine (W)	+3°C(37°F) / +13°C(55°F)		

General Regulations

Declaration of Conformity:



Refrigerant Designation	Global Warming Potential	Ambient Climate Class 5
HFC - R134a	1430	5 (all models except Thermowells./Bottle Coolers/ Bottle Wells/SmartStore/Roll-in Rubys which are Class 4)
HFC - R404a	3922	

Williams Refrigeration declares that all products manufactured by Williams Refrigeration comply with the above directives as they apply to those products, and those products are therefore declared to be in conformity with the provisions of the above legislation.



Model No.:

Serial No.:

Batteries Producer Registration Number: BPRN06225

INSTALLATION

REMOVAL OF REDUNDANT APPLIANCES

Refrigeration appliances contain refrigerant and gases in their insulation and must be disposed of professionally by a licensed waste management contractor.

Please ensure that old or redundant refrigeration appliances are disposed of safely and legally. It is recommended that doors are removed prior to disposal in order to ensure safety.

UNPACKING

Remove all external and interior packing and accessories. Ensure all such material is disposed of safely.

Check that no damage has occurred to the appliance, power cable and plug top during transit. If damage has occurred do not use the appliance.

The appliance should be installed in a well ventilated room on a flat and level floor.

We recommend that prior to use, the appliance is cleaned with a mild soap solution and then wiped dry.

VENTILATION

Refrigerators generate a considerable amount of heat and, if operated in a small unventilated room will quickly cause the room temperature to become excessive. This could cause the motor to overheat and possibly damage the compressor. At the very least, such an installation will cause the unit to use an excessive amount of electricity.

In addition to ventilation in a room, please ensure that cabinets with top-mounted systems have 500mm clearance between the cabinet top and the ceiling for engineer access and ventilation. For all other cabinets, please ensure a minimum clearance of 50mm is provided around the unit to ensure efficient and effective performance.

Do not block vents by stacking boxes on top or in front of the unit as this could affect performance and give rise to safety risk.

LEVELLING (CASTORS/FEET)

The appliance should stand level to ensure the correct operation of self-closing doors and proper drainage of condensate from the evaporator.

Models fitted with castors are non-adjustable. Therefore a level platform / floor should be provided where the appliance is to be located. Where swivel and brake castors are fitted and it has been positioned, please ensure its brakes have been activated by pressing the metal bar down. Remember to release the brakes before trying to move it.

On models fitted with legs, levelling may be achieved by adjusting the bottom section. For marine specification models with flanged feet for deck and bulkhead fixing, installation should be carried out by a specialist marine company.

WALL BRACKETS FOR A THERMOWELL (OPTIONAL EXTRA)

If the Thermowell is supplied with wall brackets, please proceed as follows;

Secure the brackets to the wall using M6 fixings and position the Thermowell upon the brackets. Ensure the feet are securely projecting through the large holes in the brackets. (See diagrams below). The Thermowell and brackets should be positioned as indicated in Figure 1.

Fixing Points:

TW9	918mm apart - 2 points
TW15	724mm apart - 3 points
TW18	900mm apart - 3 points

FIG 1.

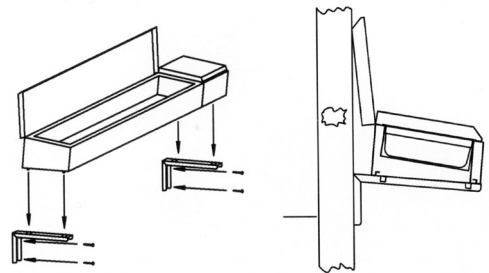

NB: Each wall bracket will support 55kg. DO NOT PLACE HEAVY OBJECTS UPON THE THERMOWELL.

STABILISING BRACKETS FOR A GLASS DOOR SAPPHIRE (OPTIONAL EXTRA)

Instructions to fix stabilising brackets to all Sapphire 1 & 2 door cabinets with glass doors is as follows;

- Using three 8 x 1/2" pozi fixings to secure Plate B to Plate A via three slots. Plate B is adjustable vertically when it has been secured to the floor.
- Three holes are provided in Plate B so it may be secured to floor. Drill and secure using sufficient fixings and plugs (not supplied).
- When Plate B has been secured to floor the fixings can be tightened and the additional holes can be drilled and secured to Plate A.

To fix bracket on cabinet LH side, repeat steps 1,2 & 3.

FIG 2.

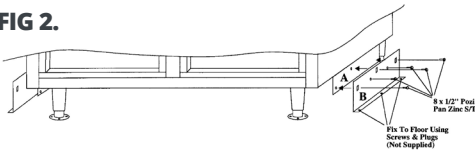

MAINS CONNECTION

The appliance is fitted with a moulded plug for safety and must be earthed. Ensure that the mains power cable is extended free from the refrigeration system equipment to avoid entanglement. We recommend supplementary electrical protection with the use of a residual current device (RCD). Periodic testing, repair and fixed wiring connections should only be undertaken by a skilled and competent electrician. If the plug or cable should fail, please contact the Williams Spares Office on +44 (0)1553 817017 for a replacement.

The equipment must be connected to the correct mains power supply as stipulated by the appliance data label and local authority regulations.

If the appliance has been laid on its back or tipped, DO NOT switch on immediately. Leave in an upright position for at least 3 hours before switching on.

CONNECTION TO A MAIN DRAIN

NB: if installing a fish cabinet, please ensure that it is connected to a main drain.

SHELF/SLIDE FITTING

When positioning slides on standard cabinets and counters, present slide to tacking by holding it in the opposite hand to the side of the cabinet to that which they are to be applied. Present slide at 45° angle (See Figure 3). When in place, let slide drop into position to create a horizontal ledge on which the shelves will sit.

Amber / Bottle Coolers are fitted with pilaster and clips (See Figure 4) for fitting. Amber freezer models are fitted with fixed shelves.

FIG 3.

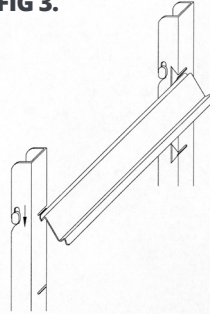
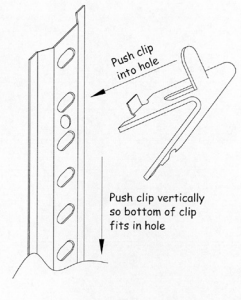

FIG 4.



LOADING / SHELF DISTRIBUTION

Before loading, allow the appliance to reach its normal operating temperature.

When loading the appliance, please ensure that its load is equally distributed throughout and ensure air can circulate around and through stored products. Ensure all items are covered and that raw and cooked foods are stored separately. Care should be taken when loading the appliance. Do not obstruct the air ducts. Take care of any parts with possible sharp edges.

LOCKING FACILITY

On models with a locking facility, it is recommended that the key be removed from its lock during normal working use. This will prevent bending or breaking of the key which could result in the lock having to be replaced.

Removing the key will also prevent accidental locking when the door is open. This will prevent the door from closing properly and cause the interior temperature to rise. If not checked in time, a loss of food may result.

OVERNIGHT OPERATION

Thermowells / Salad Units / Raised Panholder Options / Well Options / Onyx

We recommend that users remove all food products and place in suitable refrigerated storage overnight.

CONTROLLER

CONTROLLER / DISPLAY

The display should be checked daily to ensure that the correct temperature is being maintained.









CONTROLLER - TYPE A



Switching on your Appliance

Switch the appliance on or off by pressing and holding  for 3 seconds when it is in standby mode (display shows "-- --").

Key to Controls

-  Compressor running indicator
-  Defrost indicator
-  Condenser cleaning light and switch
-  Evaporator fan running indicator
-  LED display (temperature/alarm)
-  Up and down adjustment/defrost instigation
-  Enter button
-  Standby switch

CONTROLLER - TYPE B

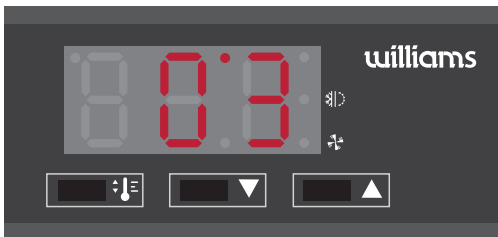

Switching on your Appliance

Your equipment is delivered ready to run. Plug it into the mains and the appliance is ready to use. '- -'

Door Alarm (Meat / Freezer upright Models only)

If the door has been left open for 5 minutes or longer then the cabinet will emit an audible alarm and 'AL' will flash in the display window. Press any button to acknowledge the alarm. The alarm will mute and 'do' will appear in the window. Shut the door and the alarm will cease. However the visual alarm continues if the door switch has a malfunction or if there is another fault. The window will show a different display - call a Service Engineer.

Hi-Lo Alarm

The controller features a built in audio / visual Hi-Lo alarm. If the temperature within the appliance exceeds the factory set alarm temperatures for 60 minutes or more, the controller will emit an audible alarm signal and 'AL' will flash until the temperature returns to normal operation.

The audible alarm may be cancelled by pressing any button. The alarm will go off again after 60 minutes if the fault has not been addressed. However, 'hi' or 'Lo' will continue to show in the LED Display until the cabinet returns to temperature or a fault is corrected.

Condenser Cleaning Light (Integral cabinets / counters only)

The LED next to the condenser cleaning button will flash to indicate the condenser requires cleaning.





NB: there is no audible alarm. This has been factory pre-set for maximum efficiency.

Cancel/Reset Condenser Clean:

Press and hold  for 5 seconds to cancel flashing LED.

will appear and the temperature will be displayed. Wait until the cabinet has reached normal operating temperature (indicated on the controller) before loading.

Key to Controls

-  Temperature set / Information menu
-  Decrease / Scroll Down
-  Increase / Scroll Up
-  Unit running indicator
-  Evaporator fan running indicator

ADJUSTING THE OPERATING TEMPERATURE

The thermostat is built in to the controller and is adjustable between factory set parameters.

All units are factory pre-set, however conditions on site will vary compared with test conditions and it may be necessary to perform the following adjustments in order to obtain a perfect temperature cycle.

ADJUSTMENT OF CONTROLLER - TYPE A

To adjust operating temperature;

Press and hold .

Use keys to adjust.  

Then release .

If no further adjustments are made within 10 seconds, the desired operating temperature will be stored, and the display will revert to the actual cabinet operating temperature.

Defrost Operation

When defrosting is in progress, a defrost indicator on the controller will become illuminated and **dF** will appear in the LED display.

Defrost is automatic and the appliance will go through a cycle at pre-set intervals. The defrost operation does raise the cabinet temperature slightly for a short period but does not affect product stored inside.

Off-Cycle defrost is carried out on the following products: General produce (H) and chilled food (CF).

Electric defrost is carried out on these products: Fresh Meat (M) and Freezer (L).

Hot Gas defrost is carried out on the Aztra Freezer (L) and PW4 Prep Well only.

To instigate manual defrost on Type A controllers only - press and hold  button or   buttons simultaneously.

RELEVANT TO BOTH CONTROLLER TYPES

Probe Fail Safe Feature

The controller features a fail-safe condition. In the event of a temperature probe failure, the compressor will alternate at 5 minute intervals indefinitely between 'running' and 'not running' and E1 or E2 will be displayed. Normal compressor function will only be restored when the probe fault has been repaired.

Should a probe failure occur please contact Williams Refrigeration Engineering Office on +44 (0) 1553 817000 for a replacement part stating the unit's serial number.

ADJUSTMENT OF CONTROLLER - TYPE B

To adjust operating temperature, press and hold  key for 3 seconds. Use   keys to adjust.

Defrost Operation

The LA135 and LA400 do not have automatic defrost. To action a manual defrost the unit should be turned off periodically (usually overnight) to enable the build-up of frost on the evaporator to melt.



To instigate a manual defrost on control panel type B only, press and hold   buttons simultaneously

THERMOSTAT ON THERMOWELLS



Temperature can be adjusted by turning the thermostat clockwise to reduce temperature and anti-clockwise to increase.

Thermowells - have been set to operate between +4°C and +8°C with thermostat located on condensor fan plate.

INFORMATION VIEW MODE - TYPE A



A single press of  will activate information view mode. It is possible to scroll forward through the references with  and backwards with .



To view a result, scroll to desired reference, press and hold , release  to stop viewing and automatically move to next parameter.



To exit information view mode, press  and  simultaneously or wait 10 seconds and controller will exit automatically.

It is possible to clear recorded values of HI, LO and CR by pressing  or  when viewing the value of relevant reference by holding button marked .

INFORMATION VIEW MODE - TYPE B

A single press of  will activate information view mode. It is possible to scroll forward through the references with  and backwards with .

To view a result, scroll to desired reference, press and hold , release  to stop viewing and automatically move to next parameter.

To exit information view mode,  and  simultaneously or wait 10 seconds and controller will exit automatically.

It is possible to clear recorded values of HI, LO and CR by pressing  or  when viewing the value of relevant reference by holding button marked .

INFORMATION VIEW MODE - RELEVANT TO BOTH CONTROLLER TYPES

The following parameters are available for viewing on both controller types:

- T1** Current air probe temperature
- * T2** Current evaporator probe temperature
- * T3** Current auxiliary probe temperature
- ** Hi** Highest recorded cabinet temperature
- ** Lo** Lowest recorded cabinet temperature
- cr** Number of weeks since last condenser clean
- * =** Optional (will only appear in information view mode if parameter T2 is set to YS and/or T3 is set to NO/AU/FP).
- ** =** If parameter T3 is set to FP, HI and LO temperatures will be logged from auxiliary probe. If T3 is not set to FP, HI and LO temperatures will be logged from air probe (T1).

APPLIANCE ROUTINE MAINTENANCE / CLEANING

ROUTINE MAINTENANCE

Safely disconnect the appliance from the power supply before cleaning, servicing or undertaking general maintenance.

We recommend that you undertake regular preventative maintenance using a qualified service provider in order to get the best from your equipment.

CLEANING

Always wear appropriate personal protective equipment (PPE) when cleaning the appliance. Care should be taken for parts with possible sharp edges.

NB: Abrasive or corrosive materials / cleaners should never be used. This includes chlorine based chemical cleaners. These can damage surfaces and cause corrosion

If the cabinet exterior is looked after correctly it will retain an “as new” finish for many years. Normal day to day cleaning should be carried out with a soft cloth and soapy water.

Dry thoroughly afterwards and where possible remove all racking, shelving and drawer fittings to aid the process.

To remove the racking and shelf supports:

First remove the shelves, then remove the shelf supports by grasping firmly in the centre and lifting slightly. Turn the shelf support towards the interior of the cabinet by pushing it in the centre as you twist the support through 90°. The shelf support will be released. (NB: the supports are designed to be anti-tilt and you may therefore experience some resistance at first which will be overcome with practice). When all shelves have been removed, remove the racking by lifting up and over the nylon retaining blocks.

Onyx:

Models are fitted with removable crumb trays to catch debris when transferring ingredients from gastronorm containers. To clean - reach behind the worktop in front of the gastronorm containers and pull the crumb tray up at an angle to project through the gap. These can be washed using warm soapy water or in a warewasher. To clean inside the raised panholder, remove gastronorm containers and stainless steel pan grid to access interior. Wash interior with warm soapy water. The pan grid can be washed in the same way and must be dried thoroughly with a soft cloth, before replacing grid.

FIG 5.

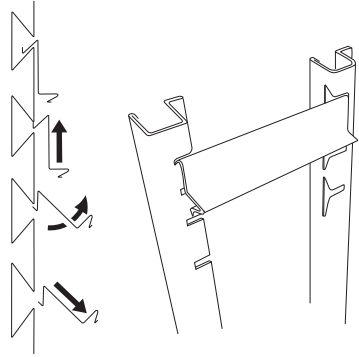

The Bottle Well is fitted with plastic coated divider(s). These can be removed easily by pulling and are dishwasher safe. The dividers should be wiped down on a regular basis with warm water and a soft cloth. It is important for them to be dried off thoroughly afterward. A removable front lid provides access to interior. (See Figure 6). To remove front lid, pull slightly forward, lift and pull. The interior can now be cleaned and any ice residue can be removed. Excess water will filter through the drainhole into a removable pan that can be accessed by removing the panel situated in the bottom left hand corner (See Figure 7). The drain pan must be emptied outside or into a suitable sink. If water appears from below the unit, please check drain pan prior to calling and engineer.

FIG 6.



FIG 7.

CONDENSER CLEANING

Regular maintenance should be carried out on a regular basis by competent / trained personnel. The condenser is part of the refrigeration unit and is located in the unit compartment.

Brush fins vertically with a stiff brush, taking care not to damage them or to push dirt / dust further in, and then vacuum away.

FIG 8.

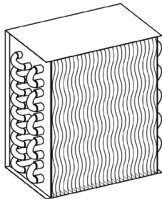

TOP MOUNTED CABINETS (Garnet/Sapphire/Jade/Crystal)

The condensing unit and refrigeration equipment can be accessed from above or in some cases behind. Remove fixings in the top and bottom edges of the unit cover and pull the unit cover away from

the cabinet and retaining clips.

BOTTOM MOUNTED UNITS (Zircon)

Pull the unit cover away from the cabinet and retaining clips.

COUNTERS WITH CASSETTE SYSTEM (Opal / Emerald / Jade)

Unlock and grasp the bottom of the unit compartment and lift slightly while pulling forward. The handle can be used to aid cassette removal. The refrigeration cassette will slide out to provide access to components. To replace the cassette, reverse the procedure (See Figure 3).

FIG 9.



Take care not to damage any electrical connections and cables during the removal and cleaning process. Please ensure the drain pipe is relocated in the vaporiser tray at the rear of the counter. Ensure the unit is unplugged when removing the system. Before plugging the counter in after cleaning, ensure all electrical cables are safe and un-damaged.

CLEANING / REPLACING THE GASKET

Door gaskets should be checked and cleaned regularly and replaced if damaged. To clean the gasket, wipe with warm soapy water and a soft cloth, ensuring it is completely dry before closing the door.

DO NOT use a sharp knife to clean or scrape the gasket. Damaged gaskets do not seal correctly and can increase the amount of electricity consumed, seriously affecting the efficiency and performance of the appliance.

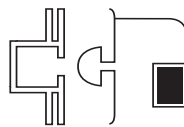

Damaged gaskets are easily replaced. Simply pull out the existing part and push the new gasket into the channel (gasket retainer) at the centre and work along, pushing gasket into channel.

EVAPORATOR/DRAINLINE

Inspect periodically to ensure the drain hole is not blocked.

BREAKDOWN

In the event of a breakdown, please contact Williams Refrigeration or your Service Provider

When calling, please advise model and serial number. This information can be found on the data plate inside the appliance. It should also be noted on the cover of this Manual. Please ensure that all redundant parts are disposed of safely and legally.

TROUBLE SHOOTING INFORMATION AND ALARM CODES

Fault Display	Possible Cause	Action
Cabinet not operating	No power supply	Check fuse or power source
Cabinet not maintaining temperature	1. Dirty condenser	Clean
	2. Air circulation restricted	Remove restriction
	3. Defective fan motor	Call engineer
	4. Defector compressor relay	Call engineer
	5. Loose electrical connection	Call engineer
Faults displayed by control	E1 or E2 - Control probe failure	Call engineer
	hi or Lo - High/low temperature alarm*	Call engineer
	do - door open alarm *	Shut door
Flashing condenser Clean LED	Condenser requires cleaning Air-cooled version *	Remove cover and clean condenser fins with clean brush

* Type A Controller Only

CHOOSING GENUINE SPARE PARTS

Choosing the correct spare parts is vital to the ongoing running of your appliance - that's why Williams Refrigeration offer a comprehensive network of servicing, support and spare parts all available directly from Williams.

Our spare parts are exactly the same quality and standard as we use to build your appliance and have been rigorously checked, tested and inspected to ensure the very best quality and exact fit.

You can contact us directly for everything from fault diagnosis to parts selection and ordering. Simply provide the serial number of your appliance and we will do the rest to ensure you receive the right part first time.

**For further information please call our Spares Department on 01553 817017
or email spares@williams-refrigeration.co.uk**

PARTS & LABOUR WARRANTY POLICY - UK ONLY

Our warranty applies to equipment manufactured by Williams Refrigeration and equipment bearing the Williams name plate and serial number identification tag.

We undertake, in conjunction with the supplying agent, distributor or representative, to repair free of charge during our standard business hours any such piece of equipment or part thereof used which is found to be faulty in either materials or workmanship subject to the further conditions below:-

WARRANTY TERMS AND PRODUCTS COVERED

We offer a **24 months Warranty** from our original date of sale with the following Williams equipment:

1. Garnet / Sapphire / Zircon / Jade / Amber (stainless) / Mobile Heated/ Mobile Refrigerated.
2. Reach-in Blast Chillers / Reach-in Blast Chiller Freezers.
3. Opal / Emerald / Onyx / Aztra / Salad Counters.
4. Crystal Bakery Cabinets and Counters.

We offer a **12 months Warranty** from our original date of sale for all other Williams equipment including:

1. All Modular Products (including coldrooms).
2. Remote Systems (including glycol).
3. Bottle Coolers.
4. Multidecks and merchandiser cases.
5. GEM product range.
6. Bottle Well / Meat Freezer Well.
7. Thermowell.
8. Non standard and other products.
9. Front of House display cases.
10. White Goods.

WARRANTY TERMS

Our warranty is offered where the equipment has been installed correctly and has not been subject to misuse or abuse and is functioning correctly.

The equipment was purchased by the authorised supplying distributor direct from Williams Refrigeration and not through a wholesaler or other supplier whose warranty terms may be different.

The Warranty Policy shall be non-transferable.

Replacement of defective equipment can only be made with the approval of Williams Refrigeration.

Any repair under warranty will only be carried out with the product in its position of operation or in a suitable location on the customer's premises. If the product has to be removed for security or any other reason, this will be subject to additional charge (may include hydrocarbon charged equipment).

Warranty work will be covered by Williams Refrigeration or by one of its appointed service agents between the hours of 8.00am and 5.00pm Monday to Friday. Any works undertaken outside of these hours are chargeable.

CLAIMS PROCEDURE

If a customer wishes to make a claim under the terms of this warranty, the following procedure should be observed:

1. Contact the supplying agent, representative or distributor.
2. Quote the equipment model, serial number and date of installation. The serial number is located on the product identification plate inside the cabinet, modular product door frame or similar location. It is recommended that operators should also record the serial number on the operating instruction booklet supplied with the product.
3. Contents risk and insurance responsibility remains at all times with the customer.

EXCEPTIONS TO STANDARD WARRANTIES

1. The Standard warranty applies to equipment located in Mainland GB only and excludes locations subject to restricted or secure access, offshore and marine applications. Additional time and travel charges may be applied to the following locations – Isle of Wight, Channel Islands, Isle of Man, Northern Ireland and Scottish Isles.

2. Any fault that is not reported within 10 working days of being discovered.
3. Service calls to equipment under warranty, or service calls made under chargeable arrangements will be carried out in accordance with standard conditions of sale. Unless otherwise specified, a maximum of 15 minutes of administrative time, not spent directly carrying out servicing work, is provided for within the supply. Any requirement for staff attending the call to spend greater time than 15 minutes due to administrative requirements, such as on waiting time or security clearance, or health and safety risk assessments, will be chargeable at our prevailing rate. We reserve the right to apply Time Travel & Call out charges if no fault is found with the product or access is either restricted or denied to our attending engineer.
4. No claim shall exceed the original selling price.
5. Claims for Food and / or contents stored in the equipment supplied (including pharmaceutical or other items) and any consequential loss how so ever arising are excluded under our warranty terms.
6. Components including gaskets, doors, drawers, handles, shelves, tray slides, all internal fixings, plug and lead, connectors, the outer shell, castors / legs, food probes, refrigerant and blockages as well as consumable items such as (but not limited to) batteries, fuses, light bulbs, printer cartridges, keys, glass and paper roll.
7. Equipment manufactured to the customers' own design, Williams Refrigeration will not be liable for any defect, non performance or improper operation of the equipment arising from any drawing design or specification supplied by the customer, their representative or agent.
8. Second hand equipment.
9. The customer uses or installs the equipment in such a way that it exceeds its design envelope or operates the equipment at control parameters other than those provided as standard factory settings.
10. The customer fails to observe commonly accepted operating practices.
11. The customer has not properly cleaned or maintained the equipment or carried out necessary servicing, including cleaning of the condenser, in accordance with instructions, literature or directions issued by Williams Refrigeration. (Operating Instructions are supplied with all equipment but also available at www.williams-refrigeration.co.uk).
12. Equipment fails through improper installation by others, misuse, abuse, accidental damage, power loss or fluctuations, fire, flooding or acts of god.
13. Any third party item(s) connected to the equipment that may affect performance.
14. The customer permits persons other than those authorised by Williams Refrigeration to perform or affect repairs or adjustments to the equipment.
15. If authorised representatives of Williams Refrigeration are denied full and free rights of access to the equipment for inspection during normal business hours as previously stated.
16. If Repairs are made using spare parts or replacement items not supplied or preauthorised by Williams Refrigeration.
17. The initial equipment supply date shall apply for warranty validity for the subsequent supply of replacement of parts or products.

EXTENDED WARRANTY

Extended Warranty offers the opportunity to protect your equipment (subject to conditions outlined) for an additional period of up to 5 years inclusive of original warranty periods.

Should you require Extended Warranty, state on your order or notify the Dealer or Williams Sales Manager at the time of purchase and they will be able to arrange it for you.

To ensure your Extended Warranty Policy remains valid, at least one maintenance / service visit per year must take place in years 2, 3, 4 and 5.

For further information or clarification please call 01553 817000 or email to info@williams-refrigeration.co.uk or write to Williams Refrigeration, Bryggen Road, King's Lynn, Norfolk, PE30 2HZ



Design Excellence : Cool Technology

Williams Refrigeration

Bryggen Road
North Lynn Industrial Estate
King's Lynn
Norfolk PE30 2HZ
Sales Tel: +44 1553 817000
Sales Fax: +44 1553 817111
Spares Tel: +44 1553 817017
Spares Fax: +44 1553 817020

info@williams-refrigeration.co.uk
www.williams-refrigeration.co.uk

Williams Silver Frost

2 rue Conventionnel Huguet
23000 GUERET
France
Tel: +33 5 55 52 27 88
Fax: +33 5 55 62 10 61

info@williams-silverfrost.com
www.williams-silverfrost.com

Williams Dubai

18th Floor
Crown Plaza Commercial Tower
Sheikh Zayed Road
Dubai
United Arab Emirates
Tel: +971 4 311 7145
Fax: +971 4 332 8860

sales@williams-dubai.ae

Williams Refrigeration Australia

38-42 Gaine Road
Dandenong South, Victoria 3175
Australia
Tel: +61 3 8787 4747
Fax: +61 3 8787 4787

sales@williamsref.com.au
www.williams-refrigeration.com.au

Williams Refrigeration Hong Kong

Unit C, 12/F., Roxy Industrial
Centre,
58 - 66 Tai Lin Pai Road, Kwai
Chung,
New Territories, Hong Kong
Tel: +852 2407 5422
Fax: +852 2407 3767

sales@williams-hongkong.com
www.williams-refrigeration.com.hk

www.williams-refrigeration.com

Williams Refrigeration is a trading name of AFE Group Limited.
Registered in England & Wales under Registered Number 3872673.
Registered Office Address - Bryggen Road, North Lynn Industrial Estate,
King's Lynn, Norfolk, PE30 2HZ

