

CVKS 611-670-671

CFKS 411-470-471

Instructions for use



Get to know your wine or bottle cooler.

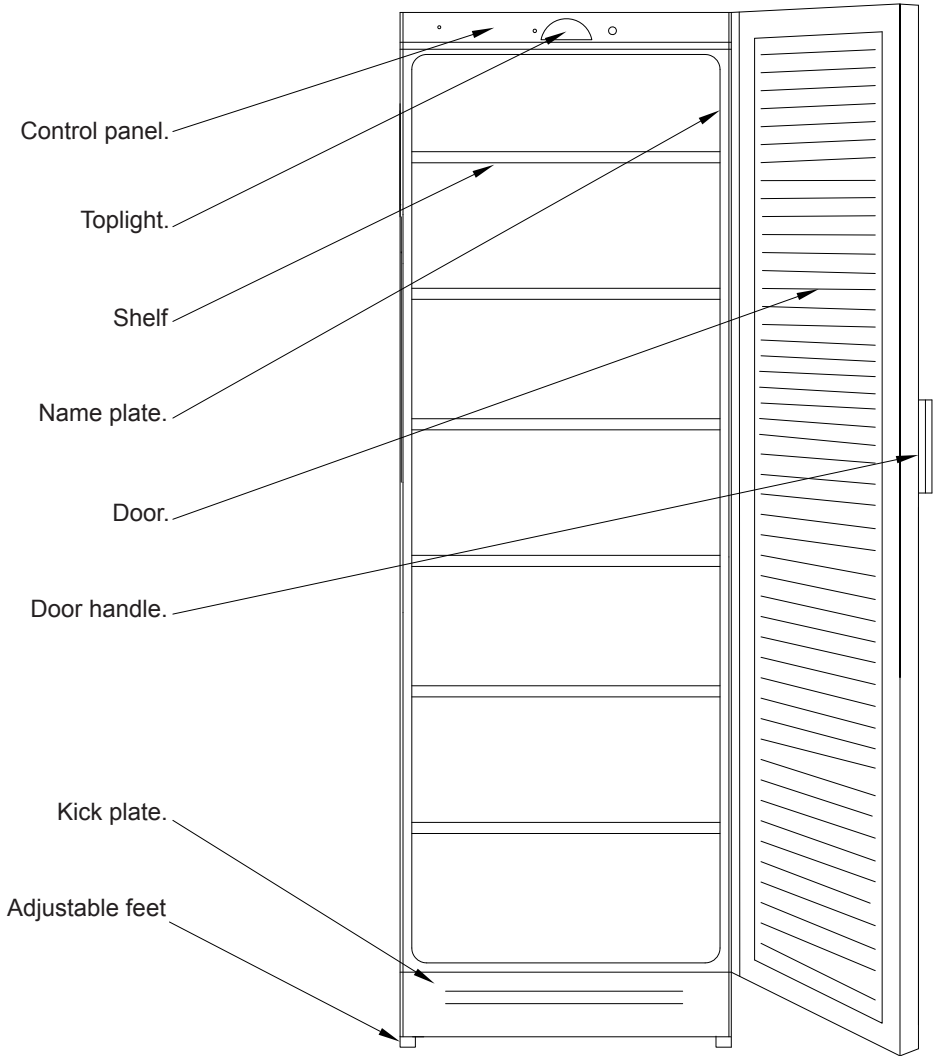

Contents

Get to know	2
Before use	3
Maintenance	3
Warning	4
Installation	5
Electrical connection.....	5
Control panel	6
Has the appliance stopped working?.....	6
General advice	6
Change of hinge side.....	7
Lock.....	8
Disposal.....	8
Warranty, spare parts and service.....	9

Maintenance

Switch off the appliance and pull out the plug when cleaning the cabinet.

Only use an unscented detergent when cleaning the cabinet inside.

You may remove the top panel and wash it when cleaning the cabinet inside.

The skirting board can be removed to facilitate a vacuum-cleaning of the floor.

To make the cooling system work at its optimum it is necessary from time to time

Before use.

This appliance is only for indoor use.

On receipt, check to ensure that the appliance has not been damaged during transport. Transport damage should be reported to the local distributor before the appliance is put to use.

Wash the cabinet and inner lining with a mild unscented detergent and wipe it dry. Do not use abrasive scouring powder, steel wool or similar.

Before operating your new appliance, please read the following instructions carefully as they contain important information on safety, installation, operation and maintenance. Keep the instructions for future reference.

If during transport the appliance has been laid down, or if it has been stored in cold surroundings (colder than +41°F), it must be allowed to stabilise in an upright position for at least an hour before being switched on.

to clean the wire condensator and the compressor at the back of the cabinet by means of a brush or a vacuum cleaner. Remember to clean the drain.

Defrosting

The evaporator is automatically defrost. The defrosted water is led to a tray on top of the compressor where it evaporates.

Warning.

In case this appliance contains hydrocarbon refrigerant please refer to guidelines listed below.

As the appliance contains a flammable refrigerant, it is essential to ensure that the refrigerant pipes are not damaged.

Standard EN378 specifies that the room in which you install your appliance must have a volume of 1m³ per 8 g of hydrocarbon refrigerant used in the appliances. This is to avoid the formation of flammable gas/air mixtures in the room where the appliance is located in the event of a leak in the refrigerant circuit. The quantity of the refrigerant used in your appliance is indicated on the rating plate.

WARNING: Keep ventilation openings in the appliance's cabinet or in the built-in structure clear of obstruction

WARNING: Do not use other **mechanical devices** or other means to accelerate the defrosting process than those recommended by the manufacturer

WARNING: Do not damage the refrigerant system

WARNING: Do not use **electrical appliances** inside the refrigerated storage compartment, unless they are of a type recommended by the manufacturer

WARNING: Do not expose the appliance to rain

WARNING: This appliance is not intended for use by young children or infirm persons unless they have been adequately supervised

by a responsible person to ensure that they can use the appliance safely. Young children should be supervised to ensure that they do not play with the appliance

- Always keep the keys in a separate place and out of reach of children
- Before servicing or cleaning the appliance, unplug the appliance from the mains or disconnect the electrical power supply
- If the supply cord is damaged, it must be replaced by the manufacturer, its service agent, or similarly qualified persons in order to avoid a hazard
- **Relevant for Australia:** Supply cord fitted with a plug complies with AS/NZS 3112.
- Frost formation on the interior evaporator wall and upper parts is a natural phenomenon. Therefore, the appliance should be defrosted during normal cleaning or maintenance
- Directions for replacing the illuminating lamps are to be included in the instruction
- Please note that changes to the appliance construction will cancel all warranty and product liability
- **WINE COOLER (CVKS)** This appliance is intended to be used exclusively for the storage of wine

Shelf

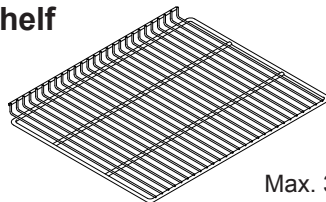

Max. 36 kg

Installation.

See drawings - page A and B.

Install the cabinet in a dry place and so that it is not exposed to direct sunlight or any other source of heat.

Place the cabinet in a level position. This is easily achieved by adjusting the adjustable feet at the front edge of the base.

The cabinet may not rest against a wall on its hinged side. When placing the cabinet on a carpet or on a wooden floor you should adjust it once more after some time as the cabinet might settle in soft foundations.

If you want to build the appliance into a cupboard you must consider 3 factors:

1. There must be space above the appliance in order to make the cooling system work satisfactorily.
2. When the door is opened the appliance takes up more room in the width and therefore the door must either be placed outside the cupboard or there must be a space of at least 0,6 inch at the hinge side.
3. The distance to the wall at the hinge side must be of a sufficient size.

Furthermore it is possible to build together two appliances. If one of these is a wine cabinet please observe a min. distance of 25mm between the cabinet in order to keep cooling performance intact.

It is safest to place the earthed wall socket above the appliance and at least 79 inch above the floor. Any local installation rules for appliances of this kind must be observed.

Electrical connection.

The technical marking of the appliance can be seen from the rating plate.

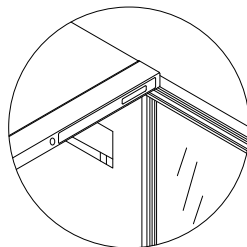

Important: Wiring and connections in power supply systems must be in accordance with all applicable (local and national) electrical codes. Consult these codes lengths and sizes prior to cabinet installation.

Power supply: According to UL 471 this equipment is intended for connection to a maximum 15 ampere 120volt single-phase branch circuit.

Maximum fuse size 10 Amps.

This appliance is equipped with a three-prong (ANSI type 5-15P grounded) plug for your protection against shock hazards. The appliance should be plugged in to properly grounded three-prong receptacle

Do not under any circumstances cut or remove the round grounding prong from the appliance plug.

Do not under any circumstances use extension cords

Control panel.

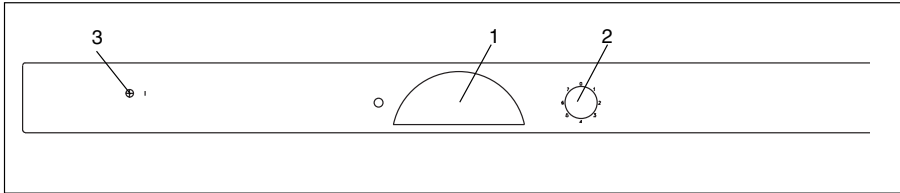

1. Lamp.
2. Thermostat knob.
3. Indicator for the connection to the electricity supply (green).

The thermostat knob is adjustable from 0 (stop) to 7 (coldest). Find the position of the thermostat which gives you the desired temperature. Start at position 4.

Has the appliance stopped working?

Before calling a repairman, check that

- The plug is properly plugged into the wall socket.
- The fuse is intact.
- The power has not been cut off.
- All controls are correctly set.
- Switch off the cabinet for 15 minutes (for instance at the thermostat). Switch it on again and after 5 minutes check whether frost has formed on the evaporator.
- Do not open the cabinet unnecessary.

General advice.

If the unit is not used for more than two days it should be switched off and the doors should be left open for ventilation to prevent a bad smell in the unit.

The appliance is equipped with a high quality skin condenser. Therefore, a slight heating of the sidewalls is quite normal.

Lighting

This appliance is equipped with a device which causes the light to switch off if the door is open / left on for abnormally long time.

When the door has been closed for a couple of minutes, the device is cut off and the light switches back on.

Change of hinge side.

1) Dismantle the top hinge. The hinge is to be used later as top hinge at the opposite side. Lift off the door..

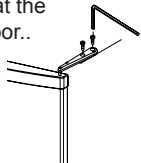

2) (For two doors) Dismantle the middle hinge. Lift off the bottom door. Mount the hinge screws again.

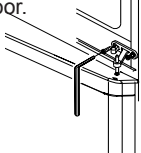

3) (For two doors) On appliances with a door closer on the upper door, this door closer should be removed and remounted on the opposite side.

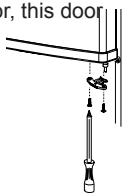

4) (For two doors) Dismantle the screws in the middle of the new hinge side. Mount the bottom door and screw on the middle hinge.

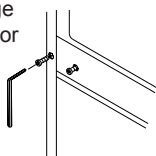

5) Remove the kick plate. The bottom hinge is dismantled at the 3 screws. The hinge is turned 180° and mounted on the opposite side.

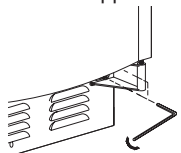

6) Adjusting the bottom door: Loosen the 3 screws in the bottom hinge and push the bottom hinge to the required side. Tighten the screws and mount the kick plate

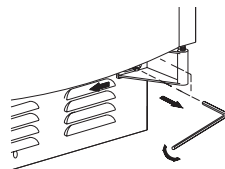

The kick plate.

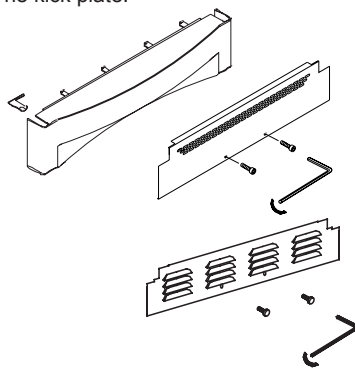

7) Adjustment of the top door: loosen the screws in the hinge above the door, loosen the hinge above the door and turn the hinge to the wanted side. Tighten the screws.

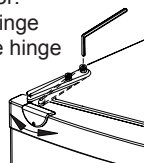

8) Move the handle.



Mounting of lock.

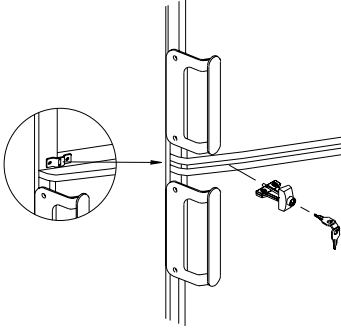

Disposal

Environmental regulations on disposal must also be observed. When disposing of the appliance you should contact your local authority technical department who will inform you of how collection and recycling of such units take place in your area.

By ensuring that this product is disposed of correctly, you will help prevent potential negative consequences for the environment and human health, which could otherwise be caused by inappropriate waste handling of this product.

Disposal must be carried out in accordance with local environmental regulations for waste disposal.

For more detailed information about treatment, recovery and recycling of this product, please contact your local city office, your household waste disposal service or the shop where you purchased the product.

Warranty, spare parts and service.

Warranty disclaimer

Faults and damage caused directly or indirectly by incorrect operation, misuse, insufficient maintenance, incorrect building, installation or mains connection. Fire, accident, lightning, voltage variation or other electrical interference, including defective fuses or faults in mains installations.

Repairs performed by others than approved service centres and any other faults and damage that the manufacturer can substantiate are caused by reasons other than manufacturing or material faults are not covered by the warranty.

Please note that changes to the construction of the appliance or changes to the component equipment of the appliance will invalidate warranty and product liability, and the appliance cannot be used lawfully. The approval stated on rating plate will also be invalidated.

Transport damage discovered by the buyer is primarily a matter to be settled between the buyer and the distributor, i.e. the distributor must ensure that such complaints are resolved to the buyer's satisfaction.

Before calling for technical assistance, please check whether you are able to rectify the fault yourself. If your request for assistance is unwarranted, e.g. if the appliance has failed as a result of a blown fuse or incorrect operation, you will be charged the costs incurred by your call for technical assistance.

Spare parts

When ordering spare parts, please state the type, serial and production numbers of your appliance. This information is given on the rating plate. The rating plate contains various technical information, including type and serial numbers.

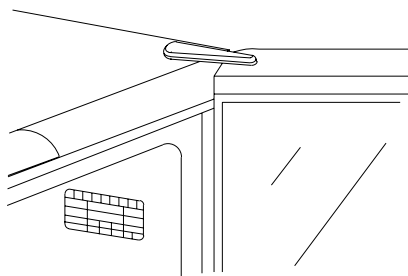

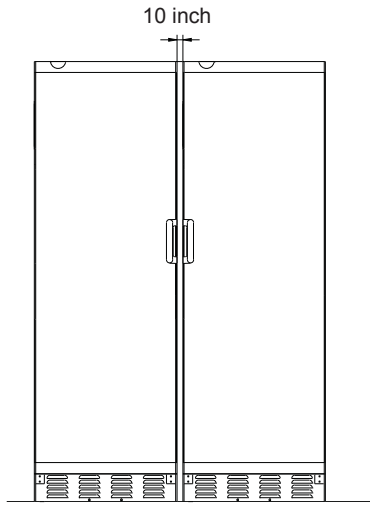
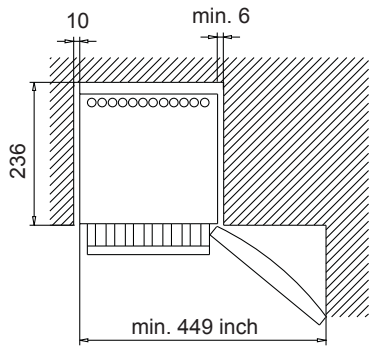
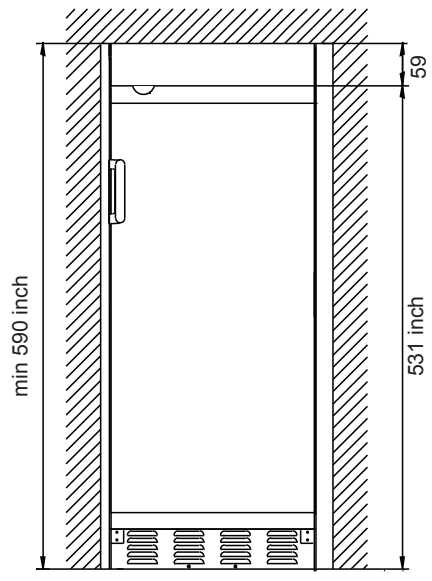
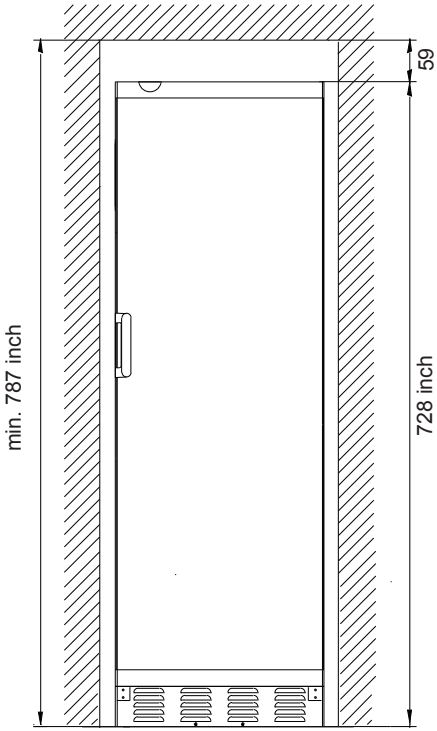

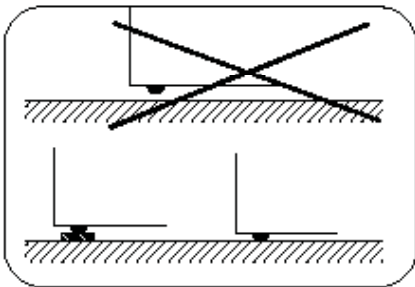
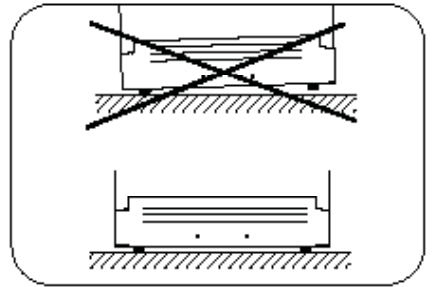
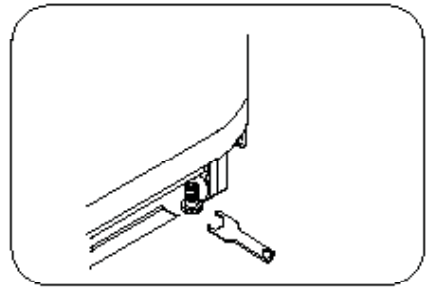
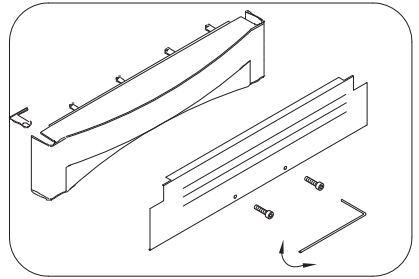
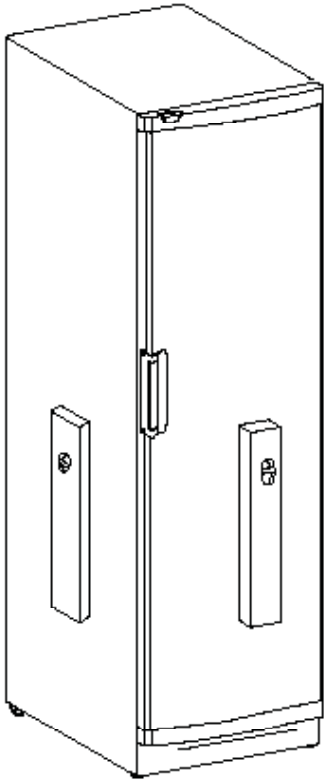

Reserves the right to alter specifications without prior notice.

91.93.121-02