

T-19F-HC

Upright Foodservice Freezer, 1 Full Solid Swing Door



Dimensions	
External Width (mm)	686
External Depth (mm)	623
External Height (mm)	1995
Exclusions	Depth does not include 13 mm for rear access panel.
Net Volume (Litres)	350
Gross Volume (Litres)	538
Supplied Shelves	4
Shelf Size (L x D mm)	582 x 464
Internal Net Height (mm)	1300
Unpackaged Weight (kg)	105
Packaged Weight (kg)	116
Packaged Dimensions (W x D x H mm)	788 x 788 x 2058
Supplied Supports	Ø 64 mm castors (83 mm height)

Build	
Door Description	1 Solid Swing Door
Door Opening	Right (standard) or Left.
Exterior Construction	Stainless steel front, aluminium sides & rear
Interior Construction	Clear coated aluminium, stainless steel base
Air Intake Position	Front
Ventilation Position	Rear
Clearance Required	26 mm rear, zero sides
Cord Length (Meters)	2.74
Internal Lighting	LED
Standard w/ Locks	standard

Technical	
Temperature Holding	-23°C
Refrigerant	R290
Voltage / Frequency / Phase	220-240V/50Hz/1
Amps	2.3
Wattage	529
Climate Class	5
Operating Statement	Heavy Duty: This appliance is intended for use in ambient temperatures up to 40°C.
Testing Standard	EN 16825
EEC	D
EEL	61.6
kWh/24hr	5.39
kWh/Annum	1970
Defrost Type	Auto



Specifications subject to change without notice.
Chart dimensions rounded up to the next whole millimeter (inches rounded up to the 1/8")

UK & Ireland
Europe
Australia

0800 783 2049
+49 (0) 7622 6883 0
+61 2 9619 9999

TFIUK@truemfg.com
TrueGermCustomerService@truemfg.com
TrueRefAus@truemfg.com



T-19F-HC

Upright Foodservice Freezer, 1 Full Solid Swing Door

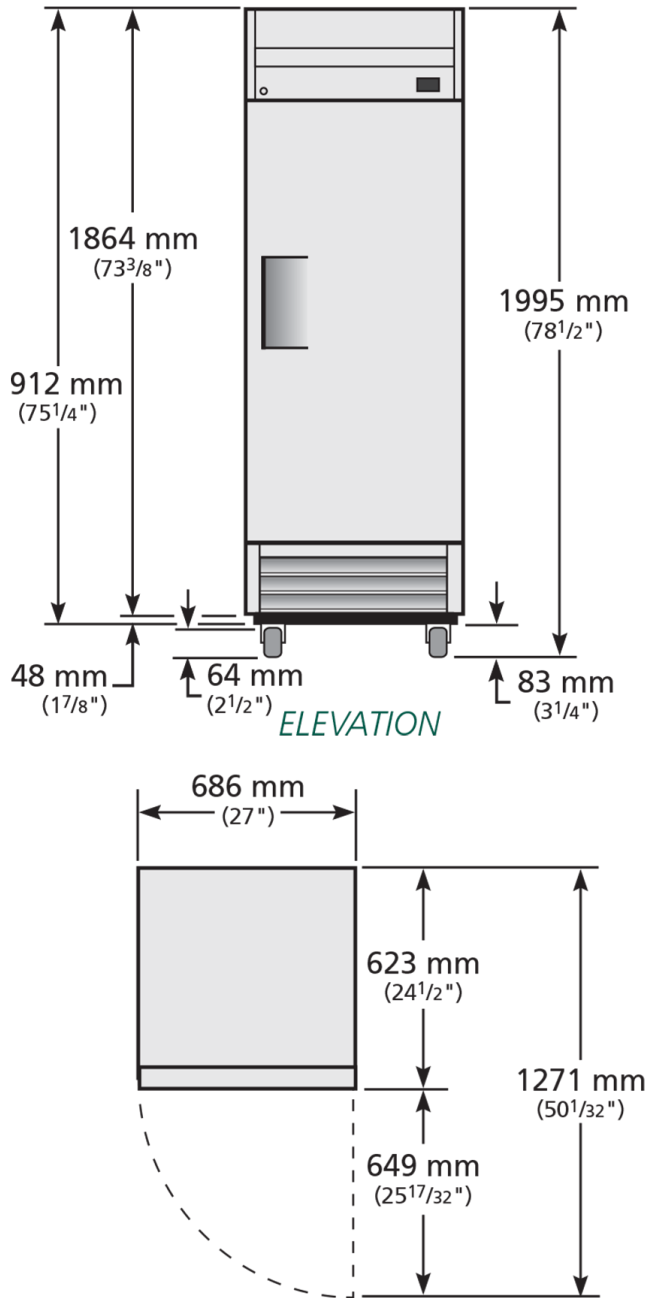

Specifications subject to change without notice.
Chart dimensions rounded up to the next whole millimeter (inches rounded up to the 1/8")

UK & Ireland
Europe
Australia

0800 783 2049
+49 (0) 7622 6883 0
+61 2 9619 9999

TFIUK@truemfg.com
TrueGermCustomerService@truemfg.com
TrueRefAus@truemfg.com

