



C615WS

PUMPED WASTE

User & Installation Guide

JUNE.2021

REF:918754

All spares available from



The Engine Shed
Top Station Road
Brackley
NN13 7UG
Tel: 0845 1308060
Fax: 01280 845345
Web: www.caterparts.com

Copyright Notice: All rights reserved. No parts of this manual may be reproduced in any form without express written permission of Maidaid-Halcyon (A trading name of Buttress Group Ltd)

1

2

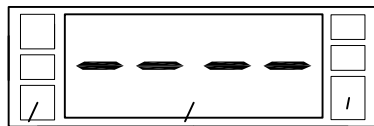

3

4

Fig.1

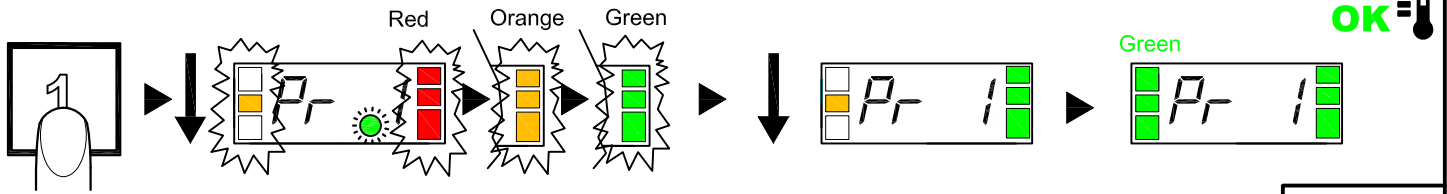
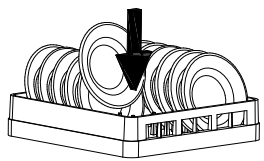

Fig.2



OK

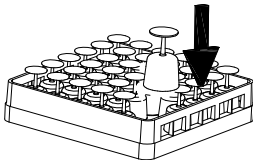
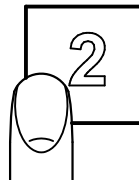

Fig.3

Fig.4



Gr EE

St EE

SA n

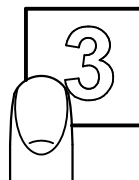

Pr 1

Pr 2

Pr 3

4

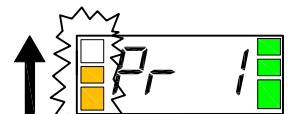

Orange



Green

End

OK

Fig.5

Fig.6

5s

4

AS

Fig.7

A

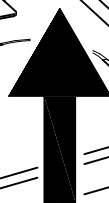

Fig.8

B



C



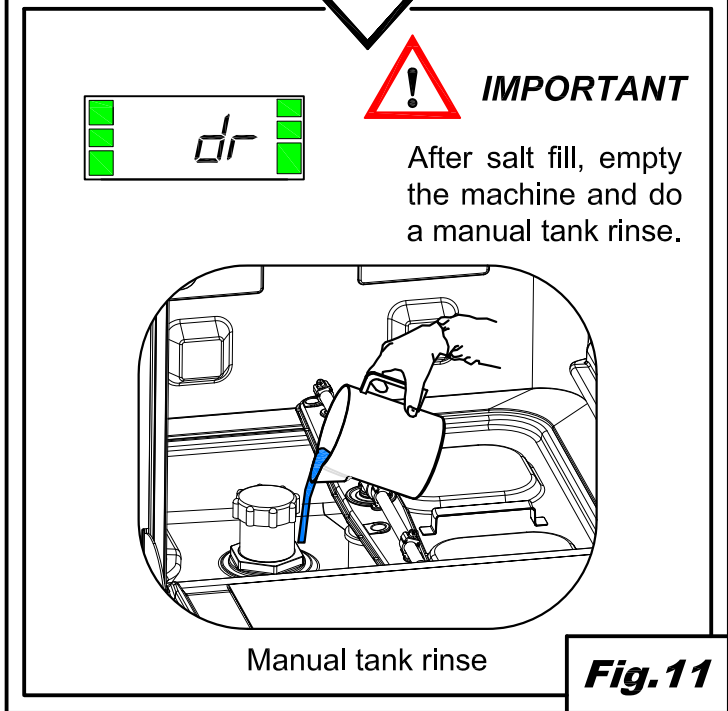
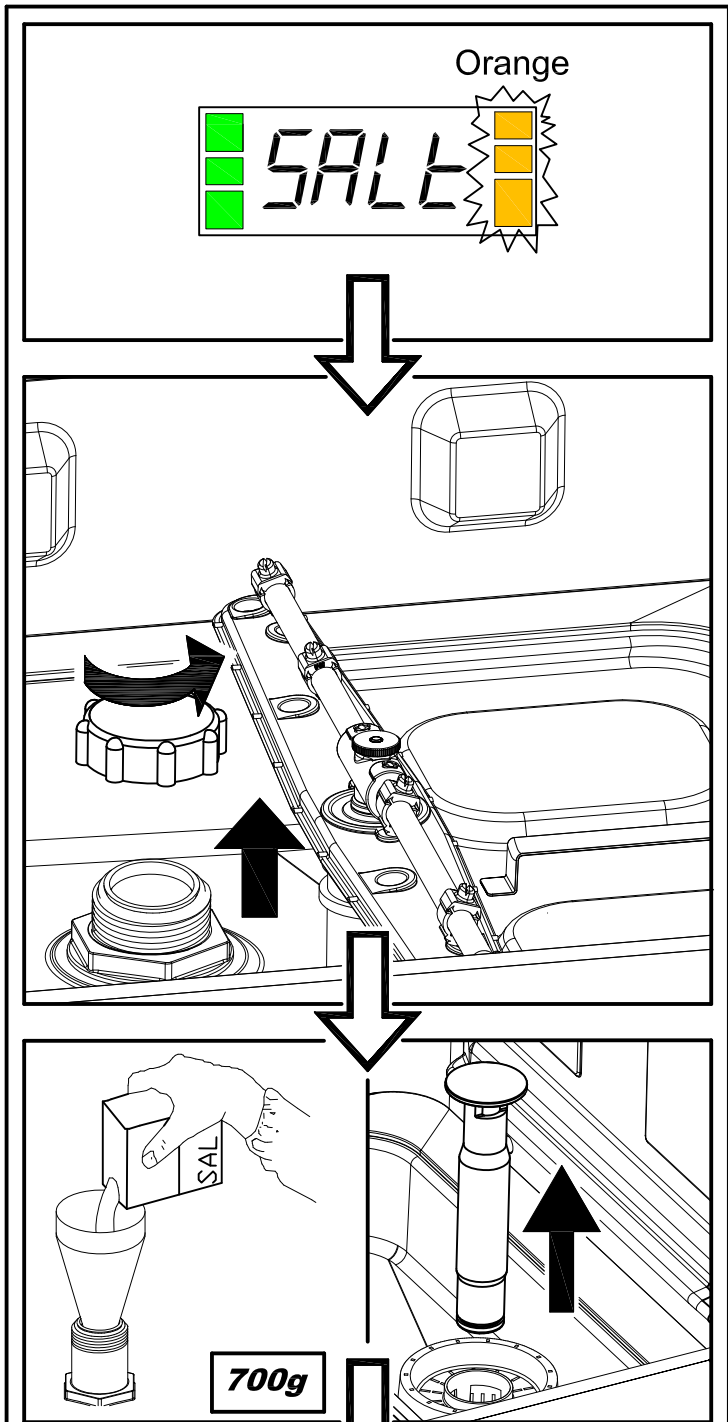
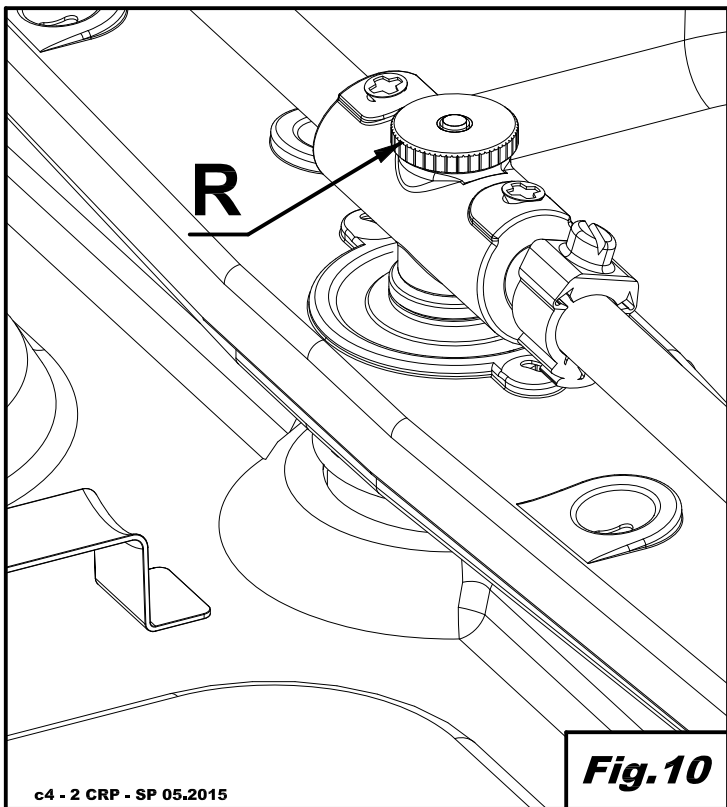
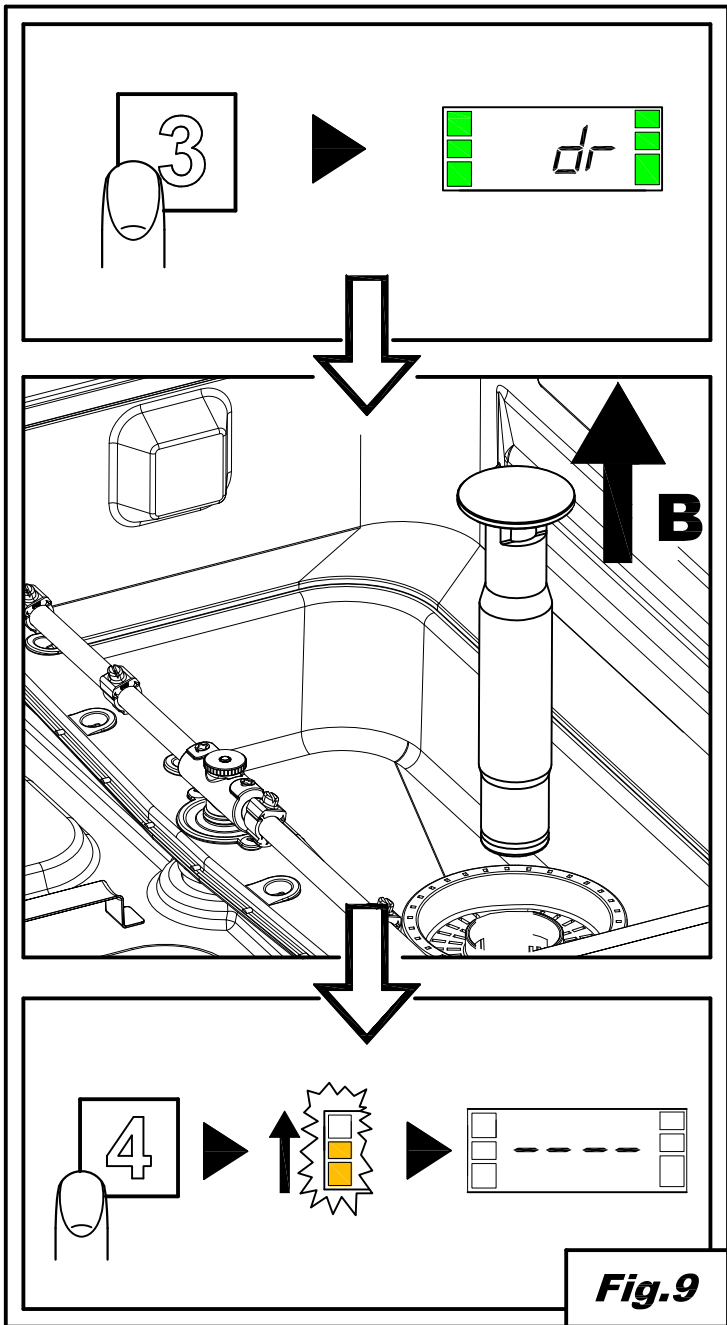

CONTENTS

CHAP 1	RISKS AND IMPORTANT WARNINGS	2
1.1	NORMAL OPERATING CONDITIONS	3
CHAP 2	PREFACE	4
CHAP 3	INSTALLATION	4
3.1	UNPACKING	4
3.2	POSITIONING	4
3.3	ELECTRICAL CONNECTION	5
3.4	WATER CIRCUIT HOOKUP	6
3.5	CONNECTION TO THE DRAIN LINE	6
3.6	RINSE AID AND DETERGENT	6
CHAP 4	USING THE MACHINE	7
4.1	KEY AND SYMBOLS	7
4.2	SWITCHING THE DISHWASHER ON	7
4.3	FILLING THE RACK	7
4.4	CYCLE SELECTION AND START-UP	7
4.5	STANDARD PROGRAMMES	8
4.6	SPECIAL PROGRAMMES (*OPTIONAL)	8
4.7	AUTOMATIC CYCLE START-UP	9
4.8	REMOVING THE INTEGRAL FILTER	9
4.9	EMPTYING THE DISHWASHER	9
	4.9.1 Appliances with no drain pump	9
	4.9.2 Appliances with drain cycle (*optional)	9
4.10	TURNING THE DISHWASHER OFF	9
4.11	RESIN REGENERATION (*OPTIONAL)	9
4.12	DISPLAYING INFORMATION	10
4.13	LIST OF VIEWABLE MESSAGES	10
4.14	END OF SHIFT	10
CHAP 5	MAINTENANCE	11
5.1	GENERAL RULES	11
5.2	CLEANING	11
5.3	CLEANING THE FILTER UNIT	11
5.4	CLEANING THE ARMS	11
CHAP 6	SELF DIAGNOSTICS	12
CHAP 7	SETTINGS	13
7.1	HARDNESS SETTINGS FOR THE INCORPORATED WATER SOFTENER	14
CHAP 8	SCRAPPING	14
CHAP 9	ENVIRONMENT	14

In legal terms, the manufacturer reserves the property of this document. It is forbidden to reproduce it or divulge it with any means without prior written authorisation.

The manufacturer reserves the right to introduce changes in order to achieve the improvements it deems necessary without prior notice.



Read the instruction manual carefully before starting the machine. The warnings contained in the manual provide important information on safety and installation, use and maintenance. Failure to observe the instructions in the enclosed documentation may compromise the safety of the appliance and immediately voids the warranty.

Chap 1 RISKS AND IMPORTANT WARNINGS

- This appliance is intended solely for the use for which it was designed. Any other use is improper and therefore hazardous.
- The specialised technician responsible for installing the appliance must instruct the user on its operation and any attendant safety measures, including practical demonstrations.
- Only the manufacturer or an authorised service centre with qualified staff may work on the machine, even in case of malfunction, using only original spare parts.
- Always disconnect or isolate the machine from its power and water supplies before servicing, repairing or cleaning it.
- The machine may **NOT** be used by persons untrained in its use.
- The appliance may be used by children aged at least 8 years old or persons with reduced physical, sensory or mental capacities, or with no experience or knowledge, provided they are supervised or after they have received training in the safe use of the appliance.
- Children must not play with the appliance.
- Cleaning and maintenance by the user must not be performed by unsupervised children.
- The machine must **NOT** be kept powered up when not in use.
- If the machine is not fitted with a plug or other device for completely disconnecting all contacts, these disconnection devices must be incorporated in the power supply, in compliance with the installation rules.
- If the power cable is damaged, it must be replaced by the manufacturer or an authorised technical assistance service, or in any case by a person with similar qualifications, to prevent all associated risks.
- The screw on the appliance marked with the IEC 60417 standard symbol 5021 represents the equipotential connection.
- **NEVER** open the machine quickly if it has not completed its cycle.
- **NEVER** use the machine with the guards installed by the manufacturer removed.
- **NEVER** use the machine to wash objects of any form, size or material not guaranteed to be machine-washable or not in good condition.
- **NEVER** use the machine or any of its assemblies as steps or support for persons, property or animals.
- **NEVER** overload the open door of front-loading machines, which is rated only to support the basket loaded with dishes.

- **NEVER** place your bare hands in the wash solution.
- **NEVER** overturn the machine after it has been installed.
- If you notice any malfunction or fluid leak, immediately disconnect the power supply and shut off the water supply.
- Do not install the dishwasher in the vicinity of heat sources over 50°C.
- **NEVER** leave the dishwasher exposed to the weather (rain, direct sunlight, etc.)
- The dishwasher may not be installed outdoors without proper cover.
- Never start a wash programme without the overflow in the tub, as applicable.
- Never place magnetic objects in the vicinity of the machine.
- Do not use the top of the machine as a table or support.
- The installer is responsible for checking that the grounding system is fully operational.
- At the end of testing, the installer must issue a written declaration stating that the machine has been installed and tested in accordance with established legislation and good practice.
- **DO NOT** change the position or tamper with the elements of the machine, as this could compromise the machine safety.
- Noise pressure level according to EN ISO 4871
 - LpA Max = 55db Kpa=2.5db for undercounter versions
 - LpA Max = 65db Kpa=2.5db for hood versions
 - LpA Max = 76db Kpa=1.5db for utensil washer versions
- Max inlet water temperature: 50°C
- Max inlet water pressure: 4bar (400kPa)
- Appliance designed for permanent connection to the water supply
- Do not clean the appliance with steam or water jets.
- Max loading height
 - On the ground in the versions with overflow
 - Maximum height 1 m in versions with discharge pump

1.1 Normal operating conditions

Ambient temperature: 40°Cmax /4°Cmin (average 30°C)
Altitude : up to 2000 metres
Relative humidity : Max 30% at 40°C / max 90% at 20°C

Warnings:

Keep all documentation in the vicinity of the appliance; make it available to the technicians and operators charged with operating it and keep it in good condition in a safe place, along with extra copies for frequent reference

The operator must read, understand and familiarise himself with the contents of this manual before working on or with the appliance.

The appliance is intended solely for professional heavy duty dishwashing applications and must be installed, operated and serviced only by qualified persons according to the manufacturer's instructions.

Warranty:

The manufacturer is not liable for any damage or injury resulting from failure to observe the instructions or improper use of the machine

Failure to observe the instructions in the enclosed documentation may compromise the safety of the appliance and immediately voids the warranty

Installation and repair by unauthorised technicians and the use non-original spare parts immediately void the warranty.

Storage:

Transport and storage: -10°C to 55°C with peaks up to 70°C (for no longer than 24 hours)

Chap 3 INSTALLATION

Proper installation is essential to the good operation of the appliance. Some of the data required for installation of the appliance are given on the nameplate on its RH body panel, and a copy is included on the cover page of this manual.

The appliance may only be installed by qualified persons authorised to do so.



For Australia and New Zealand this machine must be installed in accordance with AS/NZS3500.1

3.1 Unpacking

Check the condition of the packaging, and note any evident damage on the shipping bill. Remove the packaging and check that the appliance is in good condition; immediately report any damage to the reseller and the shipping agent by fax or registered letter with return receipt. If the damage is such as to compromise the safety of the appliance, do not install or operate it until it has been inspected by a qualified technician.



The packaging (plastic bags, expanded polystyrene, nails, etc.) are hazardous and must not be left within the reach of children or pets.

3.2 Positioning

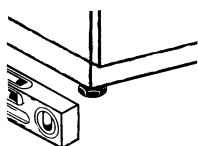

- Check that there are no objects or materials in the installation area which may be damaged by the steam emitted by the appliance during operation, or if there are, make sure they are properly protected.
- Before positioning the appliance, set up the electrical power supply, water supply and drain connections
- For flush-mounting single panel machines, leave a space of at least 10 mm between the machine walls and the adjacent surfaces.
- The floor or build-in unit must be rated to support the weight of the appliance
- To ensure that it is stable, level the appliance with its four feet.

- The appliance is intended for fixed installation only; any other approaches must be agreed with and approved by the manufacturer.
- Remove the protective film from its body panels before operating the dishwasher.

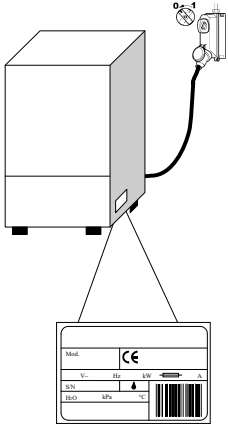

3.3 Electrical connection

- The power supply must be fitted with a omnipolar circuit breaker (master power switch) to break all contacts including neutral, with a contact gap of at least 3 mm and thermal cutout or fuses, which must be set or rated to the power indicated on the machine's nameplate.
- The master power switch must be fitted to the power line in the vicinity of the installation and may be connected to only one machine at a time.
- The mains voltage and frequency must match the nameplate ratings.
- The installation must include a grounding system conforming with established electrical safety legislation, to protect the operator and the appliance itself

- This appliance conforms to EN/IEC 61000-3-11 certification if the system impedance Z_{sys} is less than or equal to Z_{max} in the point of interface between the user's supply system and the public system. The installer or appliance user is responsible for checking that the appliance is connected exclusively to a supply with system impedance Z_{sys} less than or equal to Z_{max}

	Z_{max}
Utensil washers	0.21 Ω
Hood	0.24 Ω
Undercounter	0.41 Ω

- The power cable, which must be exclusively type H07RN-F with current capacity at 60°C on the cable:
 - Three-phase machine
 - -5x2.5 mm² up to 20 A
 - -5x4 mm² up to 30 A
 - -5x6 mm² up to 38 A
 - -5x10 mm² up to 54 A
 - Single-phase machines
 - -3x1.5 mm² up to 16 A
 - -3x2.5 mm² up to 25 A
- Must not be stretched or crushed during normal operation or routine maintenance.
- The appliance must also be connected to an equipotential system, connected by a screw marked by the symbol 5021 - IEC 60417. ⚡
- The equipotential cable must have a cross section of 10 mm².
- Respect the polarities indicated in the wiring diagram.
- For further information, refer to the wiring diagram.



Do not use multi-sockets, adapters, cables of an inadequate cross section or type or with extensions not conforming to established electrical installation regulations.

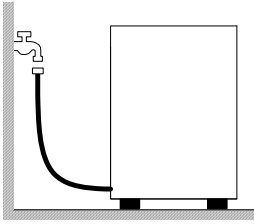

3.4 Water circuit hookup

The appliance must be connected to its water supply with a flexible hose. A shut off valve (cock) must be installed between the water supply line and the appliance's solenoid valve. The cock must be close to the appliance.

- The water supply, temperature and pressure **must be compatible** with the ratings shown on the technical data plate on the machine.
- Make sure that the water supply flow rate is no less than 20 l/min
- If the water hardness is greater than 14 °f (8 °dH), we recommend using an internal water softener. If the water hardness is greater than 35 °f (19.5 °dH), install an external water softener upline of the solenoid valve
- For machines without water softener: if the water hardness is greater than 14 °f (8 °dH), install an external water softener upline of the solenoid valve.
- If the water has a very high residual concentration of high conductivity minerals, we recommend installing a demineralisation system.
- Machines intended for use with desalinated water or in any case with high sodium chloride concentration must be ordered specifically, as they require specific construction materials
- Do not supply fully demineralised water to machines with a heat recovery unit with batteries with copper pipes. In this case, request the version with batteries with stainless steel pipes.

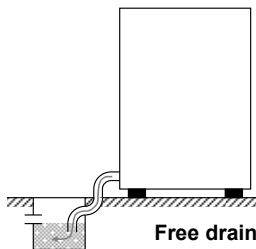

3.5 Connection to the drain line

- The drain line must consist of a free drain sump with siphon suited to the flow capacity of the drain hose supplied with the appliance. The hose must be able to reach the sump without stretching, restriction, folding, crushing, pressing or forcing in any way.
- The tub drains under gravity, so the drain sump must be lower than the machine's base.

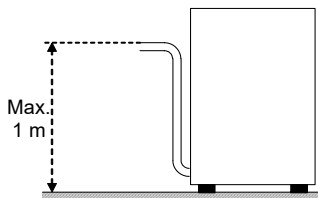

With pump (available on request)

- if the drain is not lower than the base of the appliance, you can use the version with drain pump (available on request).
- In this case, the drain connection may be no higher than 1 m.
- Always check that the drain works properly and is not blocked.
- Any other solution must be approved by the manufacturer in advance.

3.6 Rinse aid and detergent

- The rinse aid and detergent are dispensed by the machine's integral dispenser (depending on model).
- The dose is set by the installer in relation to the hardness of the water, and he also calibrates the dispensers themselves.
- Before calibrating them, fill the dispenser supply tubes with their respective product.
- The units are calibrated with the adjuster screws, or directly with the control panel (as applicable).
- The level of fluid in the container must be sufficient for priming; do not allow it to drain completely or top it up with corrosive or impure product.

NEVER use CHLORINE or HYPOCHLORITE based detergents.
We recommend installing an automatic detergent dispenser.

Chap 4 USING THE MACHINE

4.1 Key and symbols

Referring to **Fig. 1**:

1	ON/OFF BUTTON	5	INFORMATION DISPLAY
2	SPECIAL PROGRAMME SELECTION BUTTON	6	STATUS BAR (LED)
3	PROGRAMME SELECTION BUTTON	7	CHECK BAR (LED)
4	START BUTTON		

4.2 Switching the dishwasher on

Referring to **Fig. 2**:

- Turn on the main power switch and open the external water tap.
- Check that an overflow is present, if required.
- Press **ON/OFF (1)**.
- The **CHECK BAR (7)** lights up, turning from red to green to confirm the check. In the event of a serious fault, the led bar lights up in red and stops the machine operation; a minor error is indicated in orange, and will not stop the machine cycle.
- Loading begins automatically when the machine is switched on.
- The point on the display flashes until the level is reached.
- The **STATUS BAR (6)** lights up from the top downwards to indicate that the dishwasher is heating up.
- When the working temperature is reached, the **STATUS BAR (6)** stays on, lit in green.
- The optimal wash conditions have been reached.

4.3 Filling the rack

Referring to **Fig. 3**, to ensure the correct operation of the dishwasher follow the rules described below:

- Use a suitable rack, fill without overloading and without overlapping the dishes.
- Always wipe the dishes before placing in the dishwasher; do not put dishes with dry or solid residues in the washer.
- Place the empty dishes in the rack facing downwards.
- Place plates and the like in the sloping rack, with the inner surface facing upwards.
- Place the cutlery in the cutlery basket, handle end down.
- Do not place silver and stainless steel cutlery in the same cutlery basket as this will turn the silver brown and may corrode the steel.
- Wash the dishes immediately after use, in order to prevent any residue from hardening and sticking on them.
- Use only solid, dishwasher-proof dishes.

4.4 Cycle selection and start-up

- Press the **PROGRAMME SELECTION (3)** or **SPECIAL PROGRAMME SELECTION (2)** button repeatedly to select a wash cycle that is suitable for the dishes to be washed; the display will show the cycle number selected (**Fig. 4**).
- To run the programme, press **START (4)**; the **STATUS BAR (6)** starts to flash orange, increasing from the bottom upwards to indicate the progression of the cycle.
- When the cycle is finished, the bar lights up in green (**Fig. 5**).
- For rapid drying, remove the rack from the machine as soon as the cycle finishes.
- To stop a wash cycle early, press **START (4)**.

N.B. In hood versions, after the first work cycle the automatic start is automatically enabled; the subsequent cycles will be enabled automatically when the hood is closed. This operating mode is marked on the display by "AS".

4.5 Standard Programmes

<i>Pr 1</i>	Short wash programme for lightly soiled dishes.
<i>Pr 2</i>	Medium wash programme for averagely soiled dishes.
<i>Pr 3</i>	Long wash programme for heavily soiled dishes.
<i>CLE</i>	Drain and self-cleaning cycle to be used at the end of working day.
<i>dr</i>	Drain cycle.

4.6 Special programmes (*optional)

<i>Eco</i>	Reduces energy consumption by washing at lower temperatures and with reduced water consumption than normal wash programmes; a good washing result is achieved by a prolonged mechanical washing action.
<i>Act Act2</i>	Suitable for washing very dirty, even encrusted dishes that have been left for some time. The programme includes 2 washes and 2 rinses.
<i>StEE</i>	Suitable for washing forks, spoons, knives and all sorts of other cutlery. This wash programme lasts longer than the other programmes and uses a higher water temperature.
<i>rEFr</i>	Recommended when you wish to wash with a total change of water in the washing tub, so suitable for consecutive washes of particularly greasy and dirty dishes. The complete change of the water in the tub requires a longer wash cycle.
<i>PLAt</i>	Program for dishes.
<i>GLAS</i>	Suited for washing glasses of any shape or type. This programme washes with a low rinse temperature and requires a long drying time.
<i>Long</i>	Continuous wash. The cycle can be stopped at any time by pressing the Start button. After a short pause, the rinse stage will start. The cycle ends automatically after 12 minutes.
<i>SAn</i>	Recommended when the dishes to be washed also have to be sanitised. This programme controls the wash temperature and time calculating the constant A0. The programme ends when the A0 value equals 30. The length is variable, but is generally around 20 minutes and the wash temperature reaches approximately 70 C°. N.B. If you require an A0 value other than 30, contact an authorised technician, who will modify the machine software for you.
<i>Pr 5</i>	The recommended cycle for sparkling glassware; may be used only in combination with a reverse osmosis device.
<i>Pr 6</i>	Long wash programme for heavily soiled dishes (8').
<i>Pr 7</i>	Long wash programme for heavily soiled dishes (10').

Warning: the special programmes vary according to the dishwasher model.

4.7 Automatic cycle start-up

This function is used to make the chosen cycle start automatically when the door is closed. To enable, proceed as follows (**Fig.6**):

- If not made available by default, the function must first be enabled via the settings menu.
- With the appliance on and the door open, press and hold (for at least five seconds) **START (4)** until **AS** appears on the display.
- To disable the function, with the door open press **START (4)** again for five seconds.

4.8 Removing the integral filter

- Move the washing and rinsing arms at right angles to the edge of the door (**Fig.7**).
- Lift each semi-filter by the relative handle.

4.9 Emptying the dishwasher

4.9.1 Appliances with no drain pump

- Switch the dishwasher off.
- Remove the integral filter (**Fig.7A**).
- Pull up and remove the overflow pipe (**Fig.8B**).
- Wait for the tub to empty completely.
- If necessary, extract the tub filter and clean (**Fig.8C**).

4.9.2 Appliances with drain cycle (*optional)

- If present, remove the integral filter (**Fig.7**).
- If present, remove the overflow by pulling upwards (**Fig. 9**).
- Close the door.
- Select the cycle **dr**
- Press **START (4)** to start the cycle.
- The machine runs a drain cycle with self-cleaning (*where foreseen) and then switches off.
- If necessary, extract the tub filter and clean (**Fig.8C**).

4.10 Turning the dishwasher off

- Press **ON/OFF (1)**, on the **DISPLAY (5)** the central segments will light up, indicating that the machine is powered.

4.11 Resin regeneration (*optional)

In machines fitted with water softener, when the warning '**SALt**' appears you should add salt to the relative container; proceed as follows:

- Remove the basket from the machine.
- Remove the integral filter (**Fig. 7**).
- Unscrew the cap on the salt container (**Fig. 11**).
- Pour in approx. 700g of large-grain kitchen salt, using the funnel supplied. (when filling for the first time, fill the tank firstly with water)
- Close the container firmly.
- Rinse the area around the salt cap by hand and run a self-cleaning cycle to avoid any risk of corrosion.
- The '**SALt**' warning will disappear after a few minutes.

The warning **rEG** on the display indicates that the machine is running a resin regeneration cycle, needed to ensure the correct operation of the water softener; while this warning is shown, the cycles run could be longer than usual.





N.B. Do not switch off the machine if a regeneration cycle is underway

N.B. Do not switch off the machine if a regeneration cycle is underway

4.12 Displaying information

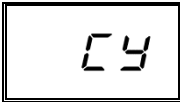
- By holding the **START** button (4) pressed for a few seconds you can display in sequence the Boiler temperature, the Tub temperature and the number of cycles performed by the machine. This information can be displayed both before and during the wash cycle and will only be visible temporarily.
- By holding the **PROGRAMME SELECTION** button (3) pressed for a few seconds you can display in sequence the Boiler temperature, the Tub temperature and the number of cycles performed by the machine.
- The function can be activated by holding the **PROGRAMME SELECTION** button (3) pressed for a few seconds.

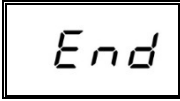
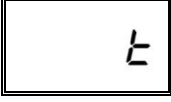
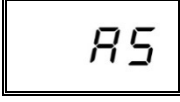
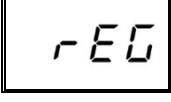
4.13 List of viewable messages

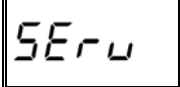
	Door open		Number of cycles carried out
	Rinse temperature		End of cycle
	Wash temperature		Automatic start enabled
	Regeneration cycle or request		Continuous wash
	No salt in the softener		Service

4.14 End of shift

- At the end of the day always drain the machine as described in the section Machine draining.
- Disconnect the power supply by means of the main switch and close the external water cock.
- Perform routine maintenance and clean the machine as described in the section Maintenance.
- If possible, leave the door ajar to prevent bad odours building up inside the machine.

Chap 5 MAINTENANCE

5.1 General rules



Before doing any maintenance, completely drain out all water, shut off the power supply and close the water supply cock.

Do not use water under pressure - it can damage the electrical equipment.

Only wash the body panelling when it is cold, using only product specifically designed for steel.

If there is a risk of ice forming, drain the water from the boiler and wash pump.

5.2 Cleaning

To keep the machine in good working order, it must be maintained regularly as explained below. We recommend periodically running a sanitising treatment with suitable non-corrosive commercial products.

5.3 Cleaning the filter unit

Run this procedure at the end of the day or when you see the filters are dirty:

1. Remove and clean the baskets.
2. Empty out the tub as explained in "Machine draining".
3. Remove and carefully clean all the filters.
4. Do not use abrasive products to clean the tub.
5. Restore all removed parts when finished.

5.4 Cleaning the arms

The wash and rinse arms are easily removed in order to clean their nozzles and prevent blockage/encrustations.

Proceed as follows (**Fig.10**):

- Remove the spray arms by unscrewing the retaining nuts or by unclipping the quick-fit attachments on machines so equipped.
- Wash all parts under a jet of running water and clean the nozzles thoroughly, using a toothpick or pointed tool if necessary.
- Clean the arm rotation pins inside the machine and the wash and rinse water drainage area.
- Restore the arms and check that they rotate freely.

Chap 6 SELF DIAGNOSTICS

The machine is equipped with a self-diagnosis system that registers and warns of a number of malfunctions.

Fault		Description and possible remedies
	E r 0 1	No rinsing. The rinsing cycle was not completed correctly. Make sure that the rinsing nozzles are clean.
	E r 0 2	No drainage. The water was not drained or drained incorrectly. Check that the drain pipe is not bent or crushed and that the siphon and filters are not blocked. In machines fitted with an overflow pipe, remove this before starting the drainage cycle.
	E r 0 3	Rinsing temperature reset fault. The boiler temperature did not reset in the set time during the washing cycle. Switch the machine off and then on and run a new cycle.
SAFE	E r 0 4	Water filling in tank fault. Make sure the pipes are connected correctly, and that the water tap is open. Where foreseen, check the presence of the overflow. Switch the dishwasher off and then on and fill again.
	E r 0 5	Tank thermometer fault. (Probe open) The machine does not read the tank temperature value. Switch the dishwasher off and then on.
	E r 0 6	Tank thermometer fault. (Probe short circuited) The machine does not read the tank temperature value. Switch the dishwasher off and then on.
	E r 0 7	Boiler thermometer fault. (Probe open) The machine does not read the boiler temperature value. Switch the dishwasher off and then on.
	E r 0 8	Boiler thermometer fault. (Probe short circuited) The machine does not read the boiler temperature value. Switch the dishwasher off and then on.
	E r 0 9	Boiler loading time out: boiler not filled. Impossible to carry out rinse cycle. Check that the water tap is open. Switch the dishwasher off and then on and run a new cycle.
	E r 2 1	Insufficient rinse: the right amount of rinsing did not take place; make sure the rinse nozzles are clean. The error does not stop machine operation.
	E r 2 2	Tank temperature reset fault: The tank temperature did not reset in the set time during the washing cycle. Switch the machine off and then on and run a new cycle.
SAFE	E r 5 F	Electro-mechanical safety device: the boiler or tub safety thermostats have cut in, or the tub safety pressure switch has been triggered.
SAFE	E r 5 L	Level safety switch: Incorrect water level in the tank.
	d r t	Dirty filter: incorrect water level in tank due to dirty filter or overflow fitted incorrectly.

WARNING! Switching the dishwasher off and then on again "resets" the signals, if after carrying out the instructions given the problem persists, contact an Authorised Service Centre.

Chap 7 SETTINGS



The following settings should only be configured by a qualified technician.

The parameters listed below can be set during installation or afterwards, accessing the settings menu as follows:

- Machine in standby with door open.
- Press buttons **1** and **2** together (**ON/OFF** and **SPECIAL PROGRAMME SELECTION**) for 5 seconds and enter the key **CH 12** (buttons **3** and **4** to change the parameter, **1** to confirm).
- Then press button **1** (**ON/OFF**) repeatedly to scroll through the following headings, enabling and/or changing them using buttons **3** and **4** (the modified parameter is memorised without being confirmed). The list of parameters may vary according to the type of dishwasher.

	Language	Language selection
b	Boiler Temperature	Boiler temperature settings for programmes. In the versions with atmospheric boiler (rinse pump) there are different settings for each programme (b1 – b2 – b3)
t	Tank Temperature	Tub temperature regulation for programmes. Rinse pump versions have different settings for each programme (t1 – t2 – t3)
tH	Thermo - Stop	Enabling the Thermostop function, which guarantees the correct rinse temperature.
ES	Energy Saving	Enabling the Energy Saving function, which guarantees energy savings when the dishwasher is on but not in use.
dn	Detergent Pump	Manual operation of detergent doser
bn	Rinse Aid Pump	Manual operation of rinse aid doser
rn	Manual Rinse	Manual operation of the rinse pump
dt	Dosage Detergent	Detergent dosing time
bl	Dosage Rinse Aid	Rinse aid dosing time
dH	Water Hardness	Setting the supply water hardness (dishwashers with water softener): enter the values given in the table below
CC	Set Number Service Cycles	Cycle counter setting and activation to enable the Service alert for an external water softener. The Service alert can be cancelled by holding pressed all 4 buttons with the machine off and the door open.
AA	Autostart Autoenabling	Automatic enabling of automatic starting
dr	Manual Drain	Manual operation of the drain pump

Once all necessary parameters have been set, to exit and memorise any changes simply press and hold button 1 for a few seconds until the on-line dashes appear.

7.1 Hardness settings for the incorporated water softener

Set the hardness level of the water supply **dH** in the settings menu following the instructions given in the following table:

Measured hardness		dH	Measured hardness		dH
°fr	dGH	n°	°fr	dGH	n°
0 ÷ 20	0 ÷ 11	1	41 ÷ 45	23 ÷ 25	6
21 ÷ 25	12 ÷ 14	2	46 ÷ 50	26 ÷ 28	7
26 ÷ 30	15 ÷ 17	3	51 ÷ 55	29 ÷ 31	8
31 ÷ 35	17 ÷ 20	4	56 ÷ 60	31 ÷ 34	9
36 ÷ 40	20 ÷ 22	5			

Chap 8 SCRAPPING

Our machines do not contain materials requiring special handling.



(Applicable in the EU and countries with sorted waste disposal)

The mark applied to the product or its documentation indicates that it must not be scrapped with domestic waste when it reaches the end of its service life. To prevent damage to the environment or health risks due to improper scrapping, keep this product separate from other waste and recycle it so as to promote sustainable use of materials.

Domestic users are requested to contact their reseller or local authority for information on sorted waste disposal and recycling for this type of product.

Corporate users are requested to contact their supplier and check the terms and conditions of the purchase contract.

The product may not be scrapped together with other commercial waste.

	Symbols	Object	Material	%
Recyclable directly		Sheet	Steel	80
		Cardboard packaging	PAP	
		Wooden pallet	ISPM15	
		Plastic parts	PP, PP+FV	
Compounds		W	Motors	20
		E	Electric parts	
		E	Electronic parts	
		E	Rubber parts	
			EPDM	

Chap 9 ENVIRONMENT

RESPECT FOR THE ENVIRONMENT

Proper use of the dishwasher can improve its environmental footprint, if the following simple rules are observed:

- Only wash full baskets.
- Switch the dishwasher off when not using it.
- Keep the machine closed when it is in standby.
- Use wash programmes suited to the amount of soiling.
- Supply the machine with hot water, if gas heated.
- Make sure the drains flow into a suitable sewer.
- Do not exceed the recommended dose of detergent.

The manufacturer reserves the right to modify the electrical, technical and aesthetic features of this appliance and replace any of its parts without notice, as he deems necessary to offer a reliable product with a long service life and advanced technology.