



## Static Oven Range

*Models:*

**CR6** (600 mm)

**CR9** (900 mm)

INSTALLATION AND OPERATION MANUAL

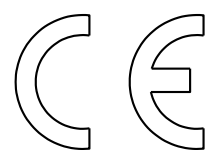

For use in GB & IE

## MANUFACTURED BY

### Moffat Limited

Christchurch  
New Zealand

## INTERNATIONAL CONTACTS

### AUSTRALIA

#### Moffat Pty Limited

**E.Mail:** vsales@moffat.com.au  
**Main Office:** (tel): +61 (03) 9518 3888  
(fax): +61 (03) 9518 3833  
**Service:** (tel): 1800 622 216  
**Spares:** (tel): 1800 337 963  
**Customer Service:** (tel): 1800 335 315  
(fax): 1800 350 281

### CANADA

#### Serve Canada

**Web:** www.servecanada.com  
**E.Mail:** info@servecanada.com  
**Sales:** (tel): 800 551 8795 (Toll Free)  
**Service:** (tel): 800 263 1455 (Toll Free)

### NEW ZEALAND

#### Moffat Limited

**Web:** www.moffat.co.nz  
**E.Mail:** sales@moffat.co.nz  
**Main Office:** (tel): 0800 663328

### UNITED KINGDOM

#### Blue Seal

**Web:** www.blue-seal.co.uk  
**E.Mail:** sales@blue-seal.co.uk  
**Sales:** (tel): +44 121 327 5575  
(fax): +44 121 327 9711  
**Spares:** (tel): +44 121 322 6640  
(fax): +44 121 327 9201  
**Service:** (tel): +44 121 322 6644  
(fax): +44 121 327 6257

### UNITED STATES

#### Moffat

**Web:** www.moffat.com  
**Sales:** (tel): 800 551 8795 (Toll Free)  
(tel): +1 336 661 1556  
(fax): +1 336 661 9546  
**Service:** (tel): 800 858 4477 (Toll Free)  
(tel): +1 366 661 1556  
(fax): +1 336 661 1660

### REST OF WORLD

#### Moffat Limited

**Web:** www.moffat.co.nz  
**E.Mail:** export@moffat.co.nz

The reproduction or copying of any part of this manual by any means whatsoever is strictly forbidden unless authorized previously in writing by the manufacturer.

In line with policy to continually develop and improve its products, Moffat Ltd. reserves the right to change the specifications and design without prior notice.

© Copyright Moffat Ltd. August 2011.

# Contents

**CR6 Gas Static Oven Ranges (600 mm Wide).**  
**CR9 Gas Static Oven Ranges (900 mm Wide).**

|               |                                       |           |
|---------------|---------------------------------------|-----------|
| <b>Part 1</b> | <b>Introduction .....</b>             | <b>2</b>  |
| <b>Part 2</b> | <b>Specifications .....</b>           | <b>3</b>  |
| <b>Part 3</b> | <b>Installation .....</b>             | <b>5</b>  |
| <b>Part 4</b> | <b>Operation .....</b>                | <b>8</b>  |
| <b>Part 5</b> | <b>Cleaning and Maintenance .....</b> | <b>11</b> |
| <b>Part 6</b> | <b>Gas Conversion .....</b>           | <b>14</b> |
| <b>Part 7</b> | <b>Replacement Parts List .....</b>   | <b>20</b> |

---

## Part 1 Introduction

We are confident that you will be delighted with your **Cobra Series** Ranges, and it will become a most valued appliance in your commercial kitchen.

To ensure you receive the utmost benefit from your new **Cobra Series** Appliance, there are two important things you can do.

### Firstly:

Please read this instruction book carefully and follow the directions given. The time taken will be well spent.

### Secondly:

If you are unsure of any aspect of the installation, instructions or performance of your appliance, contact your **Cobra Series** Range dealer promptly. In many cases a phone call could answer your question.

### CE Only:

These instructions are only valid if the country code appears on the appliance. If the code does not appear on the appliance, refer to the supplier of this appliance to obtain the technical instructions for adapting the appliance to the conditions for use in that country.

### **WARNING:**

IMPROPER INSTALLATION, ADJUSTMENT, ALTERATION, SERVICE OR MAINTENANCE CAN CAUSE PROPERTY DAMAGE, INJURY OR DEATH. READ THE INSTALLATION, OPERATING AND MAINTENANCE INSTRUCTIONS THOROUGHLY BEFORE INSTALLING OR SERVICING THIS APPLIANCE.

### **WARNING:**

INSTRUCTIONS TO BE FOLLOWED IN THE EVENT THE USER SMELLS GAS ARE TO BE POSTED IN A PROMINENT LOCATION. THIS INFORMATION SHALL BE OBTAINED BY CONSULTING THE LOCAL GAS SUPPLIER.

### **WARNING:**

GREAT CARE MUST BE TAKEN BY THE OPERATOR TO USE THE EQUIPMENT SAFELY TO GUARD IT AGAINST RISK OF FIRE.

- THE APPLIANCE MUST NOT BE LEFT ON UNATTENDED.
- IT IS RECOMMENDED THAT A REGULAR INSPECTION IS MADE BY A COMPETENT SERVICEMAN TO ENSURE CORRECT AND SAFE OPERATION OF YOUR APPLIANCE IS MAINTAINED.
- DO NOT STORE OR USE GASOLINE OR OTHER FLAMMABLE VAPOURS OR LIQUIDS IN THE VICINITY OF THIS OR ANY OTHER APPLIANCE.
- DO NOT SPRAY AEROSOLS IN THE VICINITY OF THIS APPLIANCE WHILE IT IS IN OPERATION.

### **CAUTION:**

This appliance is;

- For professional use and is to be used by qualified persons only.
- Only qualified service persons are to carry out installation, servicing and gas conversion operations.
- Components having adjustments protected (e.g. paint sealed) by the manufacturer should not be adjusted by the user / operator.
- DO NOT operate the appliance without the legs supplied fitted.

## Part 2 Specifications

### Model Covered in this Specification -

|         |       |                             |
|---------|-------|-----------------------------|
| CR6D[1] | Range | 4 Open Burners.             |
| CR6C[1] | Range | 2 Burners + 300 mm Griddle. |
| CR6B    | Range | 600 mm Griddle.             |
| CR9D[1] | Range | 6 Open Burners.             |
| CR9C[1] | Range | 4 Burners + 300 mm Griddle. |
| CR9B[1] | Range | 2 Burners + 600 mm Griddle. |
| CR9A    | Range | 900 mm Griddle.             |

[1] - Open Burner Options;  
 F - With Flame Failure Protection.  
 - Standard Burners.

### General

A heavy duty, general purpose gas range created for compact modular kitchens and available in a 600mm and 900mm wide option. It has a high option Cooktop / Griddle arrangement and is available on adjustable front feet and robust rear rollers. Open Burners have Flame Failure Option as standard for UK market and as an option for all other markets.

Griddles are available in 300 mm, 600 mm and for the CR9 Gas Static Oven Range, 900 mm options and are fitted with pilot, flame failure and piezo ignition as standard.

**The CR6 Oven** is a 490 mm (internal) full width oven fitted with French style opening doors. The oven burner is a 24-26 MJ oven burner and has pilot and flame failure with piezo ignition.

**The CR9 Oven** is a 780 mm (internal) full width oven fitted with French style opening doors. The oven burner is a 28-30 MJ oven burner and has pilot and flame failure with piezo ignition.

The Range has an easy clean stainless steel external finish.

### Gas Supply Requirements

#### - Non - UK Only:

|                           | Natural Gas                        |                               |          |          | LP Gas (Propane)                  |                               |          |          |
|---------------------------|------------------------------------|-------------------------------|----------|----------|-----------------------------------|-------------------------------|----------|----------|
|                           | Open Burner (each)                 | Griddle (each 300 mm section) | Oven     |          | Open Burner (each)                | Griddle (each 300 mm section) | Oven     |          |
|                           |                                    |                               | CR6      | CR9      |                                   |                               | CR6      | CR9      |
| Input Rate (N.H.G.C.)     | 22 MJ/hr                           | 20 MJ/hr                      | 24 MJ/hr | 28 MJ/hr | 22 MJ/hr                          | 20 MJ/hr                      | 24 MJ/hr | 28 MJ/hr |
| Supply Pressure           | 1.13 - 3.40 kPa (4.5" -13.5" w.c.) |                               |          |          | 2.75 - 4.50 kPa (11" -18.0" w.c.) |                               |          |          |
| Burner Operating Pressure | 1.0 kPa (*) (4.0" w.c.)            |                               |          |          | 2.6 kPa (*) (10.0" w.c.)          |                               |          |          |
| Gas Connection            | 3/4" BSP Male                      |                               |          |          |                                   |                               |          |          |

|                    |         | Natural Gas (G20)       |                               |                         |                         | Propane (G31)      |                               |            |            |
|--------------------|---------|-------------------------|-------------------------------|-------------------------|-------------------------|--------------------|-------------------------------|------------|------------|
|                    |         | Open Burner (each)      | Griddle (each 300 mm section) | Oven                    |                         | Open Burner (each) | Griddle (each 300 mm section) | Oven       |            |
|                    |         |                         |                               | CR6                     | CR9                     |                    |                               | CR6        | CR9        |
| Heat Input (nett)  | Nominal | 5.0 kW                  | 5.0 kW                        | 6.5 kW                  | 7.5 kW                  | 4.6 kW             | 5.0 kW                        | 6.0 kW     | 7.5 kW     |
|                    | Reduced | 1.7 kW                  | 1.5 kW                        | 1.1 kW                  | 2.2 kW                  | 1.5 kW             | 2.2 kW                        | 1.05 kW    | 2.3 kW     |
| Gas Rate (nett)    | Nominal | 0.53 m <sup>3</sup> /hr | 0.53 m <sup>3</sup> /hr       | 0.51 m <sup>3</sup> /hr | 0.79 m <sup>3</sup> /hr | 0.36 kg/hr         | 0.39 kg/hr                    | 0.47 kg/hr | 0.58 kg/hr |
|                    | Reduced | 0.18 m <sup>3</sup> /hr | 0.16 m <sup>3</sup> /hr       | 0.14 m <sup>3</sup> /hr | 0.23 m <sup>3</sup> /hr | 0.12 kg/hr         | 0.17 kg/hr                    | 0.09 kg/hr | 0.18 kg/hr |
| Supply Pressure    |         | 20 mbar                 |                               |                         |                         | 37 mbar            |                               |            |            |
| Operating Pressure |         | 10 mbar (*)             |                               |                         |                         | 28 mbar (*)        |                               |            |            |
| Gas Connection     |         | 3/4" B.S.P. Male        |                               |                         |                         |                    |                               |            |            |

#### NOTE:

(\*) The burner operating pressure is to be measured at the manifold test point with two burners operating at full setting. The operating pressure is ex-factory set, through the appliance regulator and is not to be adjusted, apart from when carrying out gas conversion, if required. (Refer to the 'Gas Conversion' Instruction Sheet for this appliance for further details).

**Gas Connection**

**CR6 Model**

Gas supply connection point is located at the rear of the appliance, approximately 130 mm from the right hand side, 45 mm from the rear and 655 mm from the floor and is reached from beneath the appliance. (Refer to the 'Dimensions' below).

For all Appliance Options, gas connection is 3/4" BSP male.

**CR9 Model**

Gas supply connection point is located at the rear of the appliance, approximately 130 mm from the right hand side, 20 mm from the rear and 655 mm from the floor and is reached from beneath the appliance. (Refer to the 'Dimensions' below).

For all Appliance Options, gas connection is 3/4" BSP male.

**Dimensions**

**CR6 Model**

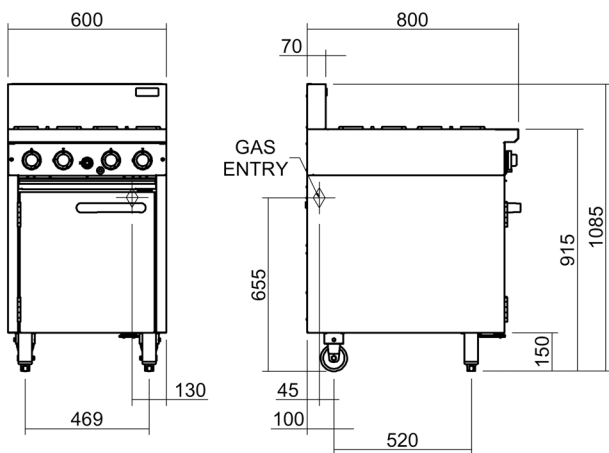

**CR9 Model**

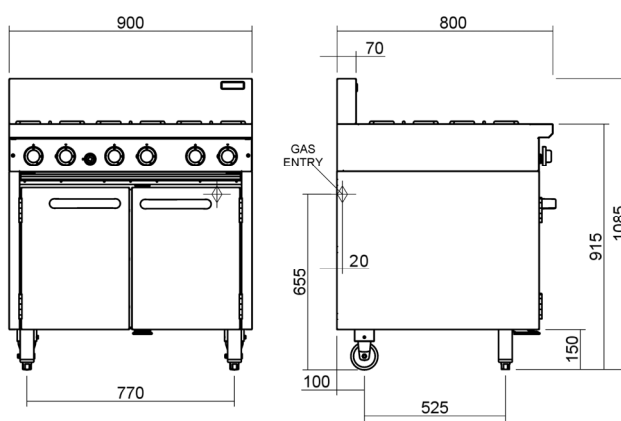

**- Cooktop Model Options**

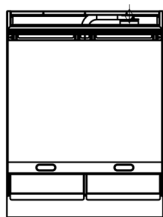

**CR6B Model**

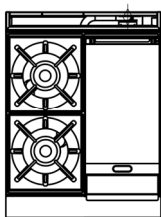

**CR6C Model**

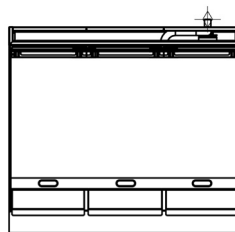

**CR9A Model**

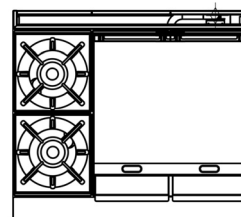

**CR9B Model**

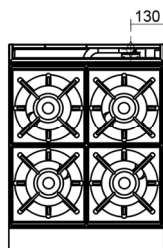

**CR6D Model**

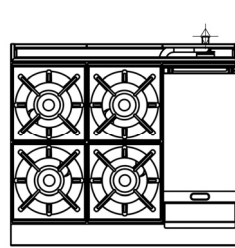

**CR9C Model**

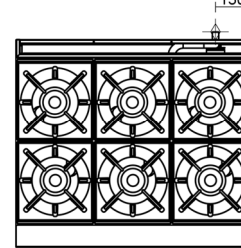

**CR9D Model**

## Installation Requirements

**NOTE:**

**It is most important that this appliance is installed correctly and that operation is correct before use. Installation shall comply with local, gas and health and safety requirements.**

**This appliance shall be installed with sufficient ventilation to prevent the occurrence of unacceptable concentrations of health harmful substances in the room that the appliance is installed in.**

**Cobra Series** Ranges are designed to provide years of satisfactory service and correct installation is essential to achieve the best performance, efficiency and trouble-free operation.

This appliance must be installed in accordance with National installation codes and in addition, in accordance with relevant National / Local codes covering gas and fire safety.

**Australia:**

AS 5601- Gas Installations.

**New Zealand:**

NZS 5261- Gas Installation.

**United Kingdom:**

Gas Safety (Installation and Use) Regulations 1998.

BS6173 - Installation of Catering Appliances.

BS5440 1 & 2 - Installation Flueing & Ventilation.

**Ireland:**

IS 820 - Non Domestic Gas Installations.

**Installations must be carried out by qualified service persons only. Failure to install equipment to the relevant codes and manufacturer's specifications shown in this section will void the warranty.**

**Components having adjustments protected (e.g. paint sealed) by manufacturer, are only allowed to be adjusted by an qualified service agent. They are not to be adjusted by the installation person.**

## Unpacking

- Remove all packaging and transit protection from the appliance including all protective plastic coating from the exterior stainless steel panels.
- Check equipment and parts for damage. Report any damage immediately to the carrier and distributor.
- Report any deficiencies to the distributor who supplied the appliance.
- Check that the available gas supply is correct to that shown on the rating plate located on the front lower corner of the R/H side panel.

## Location

1. This appliance must be installed in a suitably ventilated room to prevent dangerous build up of combustion products.
2. Installation must allow for a sufficient flow of fresh air for the combustion air supply.

**Combustion Air Requirements**

|                      |                                     |
|----------------------|-------------------------------------|
| <b>Natural Gas</b>   | <b>41 m<sup>3</sup>/hr minimum.</b> |
| <b>LPG / Propane</b> | <b>43 m<sup>3</sup>/hr minimum.</b> |

3. Never directly connect a ventilation system to the appliance flue outlet.
4. Position the appliance in its approximate working position.
5. All air for burner combustion is supplied from underneath the appliance. The legs must always be fitted and no obstructions placed on the underside or around the base of the appliance, as obstructions will cause incorrect operation and / or failure of the appliance.
6. Components having adjustments protected (e.g. paint sealed) by manufacturer are only allowed to be adjusted by a qualified service agent. They are not to be adjusted by the installation person.

**NOTE:**

**Do not obstruct or block the appliances flue. Never directly connect a ventilation system to the appliance flue outlet.**

## Clearances

**NOTE:**

**Only non-combustible materials can be used in close proximity to this appliance.**

Any gas burning appliance requires adequate clearance and ventilation for optimum and trouble free operation. The following minimum installation clearances are to be adhered to:

|              | Combustible Surface | Non Combustible Surface |
|--------------|---------------------|-------------------------|
| LH / RH Side | 250 mm (*)          | 0 mm                    |
| Rear         | 100 mm              | 0 mm                    |

\* Side clearances can be 50 mm when the adjacent surface is at least 100 mm below the cooking surface.

### Assembly

This model is delivered completely assembled. Ensure that the legs and rollers are securely attached.

**NOTE:**

**This appliance is fitted with adjustable feet to enable the appliance to be positioned securely and level. This should be carried out on completion of the gas connection. Refer to the 'Gas Connection' section.**

### Gas Connection

**NOTE:**

**ALL GAS FITTING MUST ONLY BE CARRIED OUT BY A QUALIFIED SERVICE PERSON.**

1. Cobra Oven Ranges do not require an electrical connection, they function totally on the gas supply only.
2. It is essential that the gas supply is correct for the appliance to be installed and that adequate supply pressure and volume are available. The following checks should therefore be made before installation:-
  - a. **The Gas Type** the appliance has been supplied for is shown on coloured stickers located above the gas entry point and next to the rating plate. Check that this is correct for the gas supply the appliance is being installed for. The gas conversion procedure is detailed in the Gas Conversion Instruction Sheet for this appliance.
  - b. **Supply Pressure** required for this appliance is shown in the 'Specifications' section of this manual. Check the gas supply to ensure that adequate supply pressure exists.
  - c. **Input Rate** of this appliance is also stated on the Rating Plate rating plate located on the front lower corner of the R/H side panel, and in the 'Specifications' section of this manual. The input rate should be checked against the available gas supply line capacity. **Particular note should be taken if the appliance is being added to an existing installation.**

**NOTE:**

**It is important that adequately sized piping runs directly to the connection joint on the appliance, with as few tees and elbows as possible to give maximum supply volume.**

3. Fit the gas regulator supplied, into the gas supply line as close to the appliance as possible.

**NOTE:**

**The gas pressure regulator provided with this appliance is convertible between Natural Gas and LPG as per the 'Gas Conversion Section' in this manual.**

**Ensure the regulator is converted to the correct gas type that the appliance will operate on.**

**The regulator outlet pressure is fixed ex-factory for the gas type that the regulator is converted to and it is NOT to be adjusted.**

**The regulator connections are 3/4" BSP female.**

**The connection to the appliance is 3/4" BSP male.**

(Refer to the 'Specifications' Section for the gas supply location dimensions).

**NOTE:**

**A Manual Isolation Valve must be fitted to the individual appliance supply line.**

4. Correctly locate the appliance into its final operating position and using a spirit level, adjust the legs so that the appliance is level and at the correct height.
5. Connect the gas supply to the appliance. A suitable joining compound which resists the breakdown action of LPG must be used on every gas line connection, unless compression fittings are used.
6. Check all gas connections for leakages using soapy water or other gas detecting equipment.

**WARNING:**

**DO NOT USE A NAKED FLAME TO CHECK FOR GAS LEAKAGES.**

7. Check that the gas supply pressure is as shown in the 'Specifications' section, 'Gas Supply Requirements'.

**NOTE:**

**The supply pressure to be measured at the manifold test point and with 2 burners operating at the 'High Flame' setting.**

8. Light the Main Burners. Refer to the 'Operations' Section, 'Open Burners'.
9. Verify that the supply pressure is still correct.
10. Check that the Main Burner is alight and adjust the low fire adjustment screw on the open burner gas control valves to obtain the desired flame size.
11. Check / adjust the main burner aeration gap. This gap should be set to the dimensions shown in the 'Gas Specification Tables' in 'Part 6 - Gas Conversion'.

**NOTE:**

**This appliance is fitted with adjustable feet to enable the appliance to be positioned securely and level. This should be carried out on completion of the gas connection.**



### Commissioning

The following commissioning checks must be carried out before the Range is handed over for use, to ensure that the unit operates correctly and the operator(s) understand the correct operating procedure.

1. Before leaving the new installation;
  - a. Check the following functions in accordance with the operating instructions specified in the 'Operation' section of this manual.
    - Lighting the Griddle.
    - Lighting the Open Burners.
    - Lighting the Open Burners. (F - Flame Failure Option).
    - Check the Low Fire Burner Operation.
    - Light the Oven Pilot and Main Burners.
    - Check the Oven Main Burner Thermostat operation.
    - Turning the Oven to 'Stand-By' Mode.
    - Oven 'Shut Down'.
  - b. Ensure that each operator has been instructed in the areas of correct lighting, operation, and shutdown procedure for the appliance.
2. This manual must be kept by the owner for future reference and a record of the **Date of Purchase**, **Date of Installation** and **Serial Number of the Appliance** recorded and kept with this manual. (These details can be found on the Rating Plate rating plate located on the front lower corner of the R/H side panel.

**NOTE:**

If for some reason it is not possible to get the appliance to operate correctly, shut off the gas supply and contact the supplier of this unit.

## Operation Guide

**CAUTION:**

- This appliance is for professional use and is only to be used by qualified persons.
- Only qualified service persons are to carry out installation, servicing or gas conversion operations.
- Components having adjustments protected (e.g. paint sealed) by the manufacturer should not be adjusted by the user / operator.

1. Cobra appliances have been designed to provide simplicity of operation and 100% safety protection.

2. Improper operation is therefore almost impossible, however bad operation practices can reduce the life of the appliance and produce a poor quality product. To use this appliance correctly please read the following sections carefully:-

- Lighting the Open Burners.
- Lighting the Open Burners. (F - Flame Failure Option).
- Lighting the Griddle.
- Oven Pilot Ignition.
- Oven Main Burner Thermostat.
- Turning the Oven to 'Stand-By' Mode.
- Oven 'Shut Down'.

## Description of Controls

(CR9-Gas Range 900 mm shown)

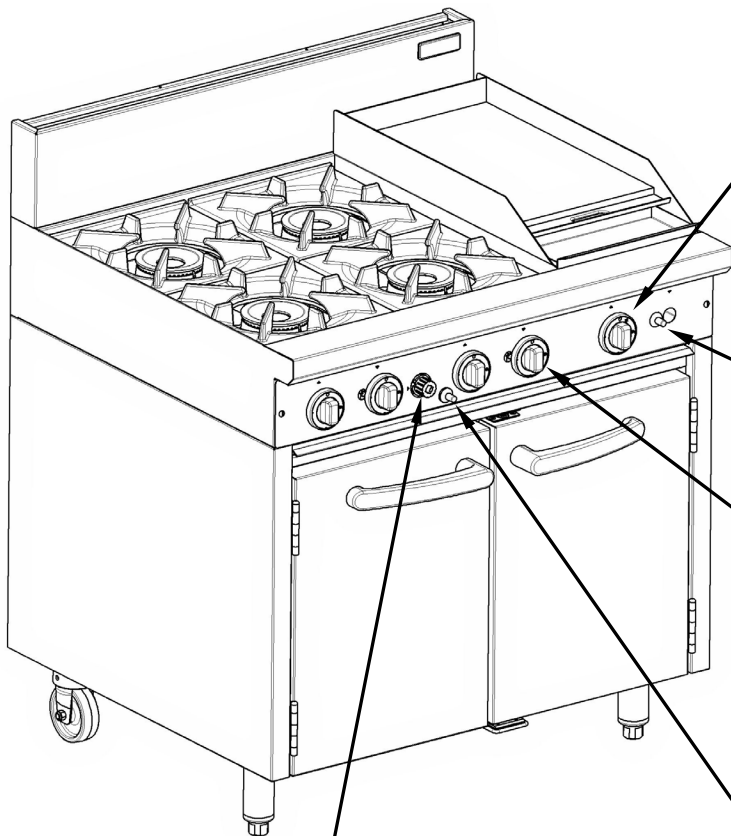

**Gas Control Knobs**

**Griddle.**

- OFF Position
- ★ PILOT Burner
- △ HIGH Flame
- △ LOW Flame

**Piezo Igniter (Griddles Only)**

**Open Burners**

- OFF Position
- △ HIGH Flame
- △ LOW Flame



(Indicators located above the Gas Control Knobs).

**Piezo Igniter (Ovens Only)**



**Oven Control**

- OFF Position
- ★ PILOT Burner

1-7 Thermostat Settings.

### Open Burners

#### NOTE:

Only cooking pans from size Ø 150 mm to Ø 420 mm are suitable for use on these open burners.

### Lighting the Open Burners

**(Flame Failure Protection is incorporated as standard for the UK Market and optional for Non -UK Markets, for each burner by way of a thermo-electric system which will shut off the gas supply to that burner in the event that the burner goes out, so that un-burnt gas is not expelled).**

- Select the burner required, depress and turn the corresponding gas control knob anti-clockwise to the 'HIGH' position.
- With the gas control knob depressed, manually light the burner.
- Release the gas control knob after approximately 10-20 seconds after lighting the burner.
- The burner should stay alight - if not, repeat Steps (a to (c above).
- To achieve simmer control, depress the gas control knob and rotate between the 'HIGH' and 'LOW' positions to achieve the temperature required.

### Turning 'OFF' the Open Burners

- When the main burner is not required, depress and turn the gas control knob clockwise back to the 'OFF' position. The 'MAIN' burner will extinguish.

### Griddle

These griddles are fitted with Pilot and Flame Failure Protection as a standard option, which is incorporated by way of a thermo-electric system for each main burner. Flame Failure Protection will shut off the gas supply to that burner in the event that the pilot for that burner goes out, so that un-burnt gas is not expelled. **This is an important safety feature which is slowly becoming law throughout the world.**

#### **CAUTION:**

**The griddle plate temperature reaches over 300°C in hottest points during normal operation at 'Full Flame' setting.**

### Lighting the Griddle

- Depress the gas control knob and rotate anti-clockwise to the 'PILOT' position.
- With the gas control knob depressed, press the piezo ignition button to ignite the pilot burner. Repeat Items 1 to 2 until the pilot is lit.
- Release the gas control knob approximately 10 to 20 seconds after lighting the pilot.

- The pilot should now remain alight - if not, repeat Steps (a. to (c. above).
- 'Full Flame' can now be achieved by depressing and rotating the gas control knob anti-clockwise to the first stop.
- Low flame can be achieved by depressing the gas control knob and rotating fully anti-clockwise to the 'Low Flame' position.
- When the main burner is not required, depress and turn the gas control knob clockwise back to the 'PILOT' position. The griddle burner will extinguish and the pilot will remain alight.

### Turning 'OFF' the Griddle Burner / Pilot

- To turn 'OFF' the 'PILOT', depress and turn the gas control knob clockwise back to the 'OFF' position. The 'PILOT' burner will extinguish.

### Oven

#### - Pilot Burner Ignition

#### **WARNING:**

**HEAT EXPOSURE DANGER EXISTS WHEN OPENING THE OVEN DOOR WHILE THE OVEN IS STILL HOT.**

This oven is fitted with a pilot as standard option and flame failure protection, which is incorporated by way of a thermo-electric system for the main burner. Flame failure protection will shut off the gas supply to the burner in the event that the pilot burner goes out, so that un-burnt gas is not expelled. **This is an important safety feature which is slowly becoming law throughout the world.**

#### **! IMPORTANT**

**DO NOT USE aluminium foil or trays directly on the oven tray or flame baffle. NEVER block or cover the openings on each side of the flame baffle.**

- Depress and rotate the thermostat control knob anti-clockwise to the 'PILOT' position.
- While holding the thermostat control knob depressed, press the piezo ignitor button to light the oven pilot burner. If required, repeat Items 1 to 2 until the oven pilot burner is lit.
- View the oven pilot burner through the hole in the front lower sill, with the oven door open.
- Release the thermostat control knob approximately 10-20 seconds after lighting the pilot burner.
- The pilot burner should now remain alight - if not, repeat Steps 2 to 4 above.

### - Main Burner / Thermostat

1. With the pilot burner alight, rotate the oven thermostat control knob to the desired oven temperature setting, this will regulate the gas supply to the oven burner and the oven main burner will light from the pilot burner.
2. To turn the main burner 'OFF', simply turn the thermostat control knob to the 'OFF' position.
3. The oven thermostat control knob is marked 1 to 7.
4. The thermostat can be set anywhere within this range and will thermostatically maintain oven temperature.
5. The following chart indicates approximate oven centre temperatures that will be maintained at the knob markings.

#### Gas Mark Temperature Conversions

**NOTE:**

**Approximate guide information only.**

#### GAS MARK

|            |            |            |            |            |            |            |
|------------|------------|------------|------------|------------|------------|------------|
| <b>1</b>   | <b>2</b>   | <b>3</b>   | <b>4</b>   | <b>5</b>   | <b>6</b>   | <b>7</b>   |
| <b>100</b> | <b>130</b> | <b>160</b> | <b>190</b> | <b>225</b> | <b>260</b> | <b>290</b> |

#### TEMPERATURE °C

6. Temperatures required between the above should be obtained by setting the control between the markings.

### Turning the Oven to 'Standby' (Pilot 'ON' Only)

1. To turn 'OFF' the oven main burner / heating, set the oven thermostat control knob to the 'PILOT' position, this will turn the oven 'OFF', but leave the oven pilot burner 'ON'.
2. In this position the pilot burner will remain alight, but the main burner will not operate until the oven thermostat control knob is set to a temperature.

### Oven 'Shut-Down'

To 'Shut Down' the oven, turn the oven thermostat control knob to the 'OFF' position. This will turn 'OFF' the oven and extinguish the pilot burner. To relight the pilot burner, refer to 'Pilot Burner Ignition' in this section.

#### IMPORTANT

**Should any abnormal operation like;**

- ignition problems,
- abnormal burner flame,
- burner control problems,
- partial or full loss of burner flame in normal operation,

**be noticed, the appliance requires IMMEDIATE service by a qualified service person and shall not be used until such service is carried out.**

### General

**CAUTION:**

Always turn off the gas supply at the mains supply before cleaning. This appliance is not water proof. Do not use water jet spray to clean interior or exterior of this appliance.

### General

Clean the Range regularly. A clean Range looks better, will last longer and will perform better. Carbonised grease on the surface or between the trivets, griddle plates will hinder the transfer of heat from the cooking surface to the food. This will result in loss of cooking efficiency.

**NOTE:**

**NEVER use a ribbed scraper blade on the flat surfaced griddle plate.**

**DO NOT use water on the trivets, burners and griddle plates while these items are still hot as warping and cracking may occur. Allow these items to cool down and then remove for cleaning.** The entire trivets, griddle plates and burner caps can be dismantled for cleaning.

**NOTE:**

- **DO NOT use abrasive detergents, strong solvents or caustic detergents as they could corrode or damage the Range.**
- **In order to prevent the forming of rust on the trivets, griddle plate (if fitted) and burners, ensure that any detergent or cleaning material has been completely removed after each cleaning. The appliance should be switched 'On' briefly to ensure that the griddle plates become dry. Oil or grease should be spread over the griddle surface in order to form a thin protective greasy film.**

To keep your Range clean and operating at peak efficiency, follow the procedures shown:-

### After Each Use

**CAUTION:**

Always ensure that if using a flat scraper tool on the griddle surface, an even pressure is applied over the whole surface of the scraper tool to prevent scoring of the surface.

**NEVER bang the sharp edge of the scraper tool on the flat surface of the griddle as this will damage the griddle and invalidate the warranty.**

1. Clean the Griddle and Range castings using a scraper tool to remove any build up of carbon.

2. Always ensure that scraper tool blades are changed regularly to ensure that the scraper tool works efficiently and prevents damage to the griddle plate surface.
3. Clean the range castings with a stiff nylon brush or a flexible spatula to remove any food debris.

### Daily Cleaning

1. The grease / spill tray(s) should be checked and emptied frequently to prevent overflow and spillage. Remove the spill tray(s) while still warm so that the grease is in a liquid state. Empty any grease from the trays and wash the trays thoroughly in the same manner as any cooking utensil.
2. Clean the control panel with a damp cloth lightly moistened with a solution of mild detergent and water. Wipe dry with a clean dry cloth.
3. Remove the burner caps, bases, the trivets and thoroughly clean including the splash back, interior and exterior surfaces of the range with hot water, a detergent solution and a soft scrubbing brush.
4. Brush the griddle surface (optional - if fitted) with a soft bristled brush. Any carbon deposits should be removed using a scraper tool followed by wiping with a cloth to prevent accumulation of food deposits.
5. Dry the Range thoroughly with a dry cloth and polish with a soft dry cloth.

### Weekly Cleaning

**NOTE:**

- **If the Range usage is very high, we recommend that the weekly cleaning procedure is carried out on a more frequent basis.**
- **Ensure that protective gloves are worn during the cleaning process.**
- **DO NOT use harsh abrasive or caustic detergents or strong solvents as they will damage the cooktop, burners and griddle plates (if fitted).**
- **DO NOT use water on the trivets, griddle plates and burners while they are still hot as cracking may occur. Allow these items castings to cool and remove for cleaning.**
- **DO NOT clean the burners in a dishwasher.**

### Range Cooking Area

- a. Clean the Range cooking area using a soft cloth moistened with a mild detergent and hot water solution.
- b. Baked on deposits or discolouration may require a good quality stainless steel cleaner or stainless steel wool. Always apply cleaner when the appliance is cold and rub in the direction of the grain.
- c. It should not be necessary to remove the splash guards covering the burner manifolds for cleaning purposes. These can be cleaned in situ.
- d. Remove the grease / spill tray(s) and clean with a mild anti bacterial detergent and hot water solution using a soft bristled brush. Dry the grease spill tray(s) thoroughly with a dry cloth.

### Griddle Plate

**CAUTION:**

**Always ensure that if using a flat scraper tool on the griddle surface, an even pressure is applied over the whole surface of the scraper tool to prevent scoring of the surface.**

**NEVER bang the sharp edge of the scraper tool on the flat surface of the griddle as this will damage the griddle and invalidate the warranty.**

**NOTE:**

In order to prevent the forming of rust on the griddle plate, ensure that all detergent and cleaning material has been entirely removed after each cleaning process. The appliance should be switched on briefly to ensure that the griddle plate becomes dry. Oil or grease should be spread over the griddle surface in order to form a thin protective greasy film.

- a. Remove and clean the grease / spill tray(s) frequently to prevent over spills.
- b. Clean the griddle surface thoroughly with a scraper tool or a wire brush. If necessary use a griddle stone or a scotch bright pad on the griddle surface to remove stubborn or accumulated carbon deposits.
- c. A scraper tool can be used for the removal of stubborn carbon and deposits.
- d. Occasionally bleach the griddle plate with vinegar when the plate is cold.
- e. Clean with hot water, a mild detergent solution and a scrubbing brush. Dry all components thoroughly with a dry cloth.
- f. The Range should be switched on briefly to ensure that the griddle plate becomes dry. A thin smear of cooking oil should be spread over the grates in order to form a protective film.

### Trivets and Burners

- a. Remove the trivets from the top of the appliance, taking note that the trivets are manufactured with a lip on one edge, the lip must always be fitted to the outer edge (front and back) of the Range.
- b. Remove the burner cap and burner complete with venturi tube, from the top of the range manifold, taking care not to damage the thermocouple (Fitted as standard for UK Market and optional for Non -UK Markets) fitted to the mounting rail.
- c. The trivets and burners should be cleaned with a mild detergent and hot water solution using a soft bristled brush. Dry thoroughly with a dry cloth.

### Trivet Supports

- a. Remove all the trivet supports from the top of the range. Take note of the orientation of the trivet support when removing. The trivet support front side rail profiles are different from the rear side rail profiles.
- b. The trivet supports should be cleaned with a mild detergent and hot water solution using a soft bristled brush.
- c. Dry the trivet supports thoroughly with a dry cloth.

**NOTE:**

**On units fitted with Flame Failure Thermocouples as standard or as an option, the Mounting Rail is Not removable for cleaning and no attempt should be made to remove this rail.**

### Stainless Steel Surfaces

- a. With the griddle plates and burners removed, clean the interior and exterior surfaces of the Range with hot water, a mild detergent solution and a soft scrubbing brush. Note that the gas control knobs are a push fit onto the gas control valve spindles and can be removed to allow cleaning of the front of the control panel.
- b. Baked on deposits or discolouration may require a good quality stainless steel cleaner or stainless steel wool. Always apply cleaner when the appliance is cold and rub in the direction of the grain.
- c. Dry all components thoroughly with a dry cloth and polish with a soft dry cloth.
- d. Remove the grease tray and clean with a mild anti bacterial detergent and hot water solution using a soft bristled brush.
- e. Dry the grease tray and all components thoroughly with a dry cloth and polish with a soft dry cloth.

### Re-Fitting the Components to the Range

- a. Refit the trivet supports to the Range top, ensuring that the trivet supports are correctly fitted.

#### NOTE:

- **It is imperative that the trivet supports are correctly re-fitted to the appliance to ensure that the burners and trivets locate correctly and sit flush and level.**
  - **Note the orientation of the trivet supports when re-fitting. The trivet support front side rail profiles are different from the rear side rail profiles and will only fit one way to the cooktop.**
- b. Refit the burners and burner caps onto the Range cooktop.
  - c. Refit the trivets to the cook top, taking note that the trivets are manufactured with a lip on one edge, the lip must always be fitted to the outer edge (front and back) of the range.
  - d. Refit the spill / grease tray(s) to the range.

### Oven Interior

- a. Do not use wire brushes, steel wool or other abrasive materials to clean the oven interior.
- b. Clean the oven regularly with a good quality domestic oven cleaner.
- c. Once a week, remove and clean any built up of grease etc. from the oven racks and the bottom spill over cover.
- d. Dry the oven thoroughly with a dry cloth and polish with a soft dry cloth.

### Periodic Maintenance

#### NOTE:

**All maintenance operations should only be carried out by a qualified service person.**

To achieve the best results cleaning must be regular and thorough and all controls and mechanical parts should be checked and adjusted periodically by a qualified service person. If any small faults occur, have them attended to promptly. Don't wait until they cause a complete breakdown. It is recommended that the appliance is serviced every 6 months.

### Gas Control Valve Re-Greasing

The gas control valve should be dismantled and greased every 6 months to ensure the correct operation of the gas control valve.

To carry out this operation;-

- a. Remove the gas control knobs from the gas tap spindles by pulling the knobs away from the control panel.
- b. Remove the drip tray from the appliance.
- c. Remove the two screws on the underside of the control panel, securing the control panel to the hob.
- d. Remove the control panel from the front of the appliance.
- e. Remove the 2 screws holding the shaft plate to the gas control body and remove the control shaft and plate. Note the orientation of shaft for correct re-assembly.

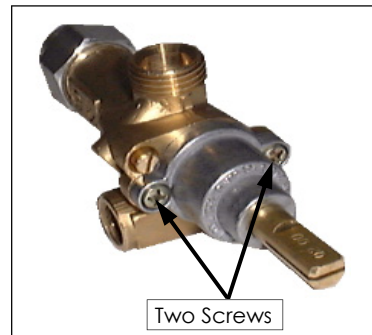

- f. Using needle nose pliers or similar, pull out the gas control spindle, again noting its orientation.

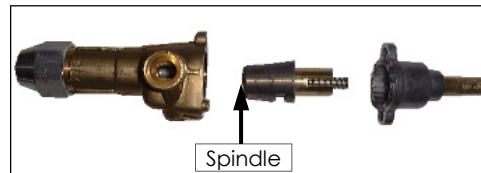

- g. Apply a suitable high temperature gas cock grease or lubricant such as ROCOL - A.S.P (Anti scuffing paste) / Dry Moly Paste to the outside of the spindle.
- h. Replace spindle and re-assemble the gas control valve in reverse order.
- i. Refit the control panel to the appliance and secure with the 2 screws.
- j. Refit the knobs to the gas control valve spindles.

## Gas Conversion Procedure

**CAUTION:**

Ensure that the unit is isolated from the gas supply before commencing servicing.



**NOTE:**

- These conversions should only be carried out by qualified persons. All connections must be checked for leaks before re-commissioning the appliance.
- Adjustment of components that have adjustments / settings sealed (e.g. paint sealed) can only be carried out in accordance with the following instructions and shall be re-sealed before re-commissioning this appliance.
- For all relevant gas specifications refer to the table at the rear of this section.

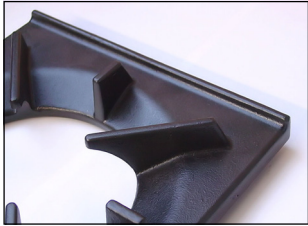
### Open Burners

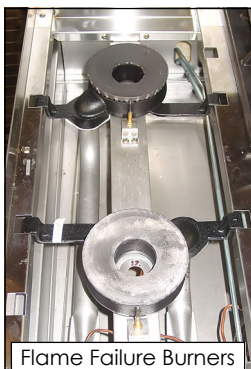
1. Turn 'OFF' the gas supply at the main supply.
2. Remove the trivets from the top of the appliance, taking note that the trivets are manufactured with a lip on one edge, the lip must always be fitted to the outer edge (front and back) of the Range. 
3. Remove the burner caps and the burners (these are a loose fit to the range) from the top of the range. (On Flame Failure units, take care not to damage the thermocouple which is fitted to the mounting rail. Fitted as standard for UK Market and optional for Non -UK Markets).

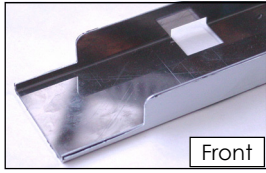

4. Remove all the trivet supports from the top of the appliance. **Take note of the orientation of the trivet supports when removing. The trivet support front side rail profiles are different from the rear side rail profiles.**  
5. Unscrew and remove the injectors (1/2" A/F) from the gas cocks.
6. Determine the correct injector sizes for the corresponding gas from the rating plate which is attached to the underside of the right hand side front, Range lower trim.
7. Replace with the correct size injectors. Refer to the 'Gas Specifications' table at the rear of this section, for correct injector sizes.
8. Refit all the trivet supports to the top of the appliance. **Note the orientation of the trivet supports when re-fitting. The trivet support front side rail profiles are different from the rear side rail profiles and will only fit one way to the range.**
9. Refit burners and burner caps onto the range.
10. Turn on the gas supply at the mains, re-light the burners and check the flame size on the simmer (LOW) position.

**NOTE:**

The right hand gas control valve supplies the rear burner and the left hand gas control valve supplies the front burner.

11. Refit the trivets to the top of the appliance, taking note that the trivets are manufactured with a lip on one edge, the lip must always be fitted to the outer edge (front and back) of the range.

### Low Fire Adjustment

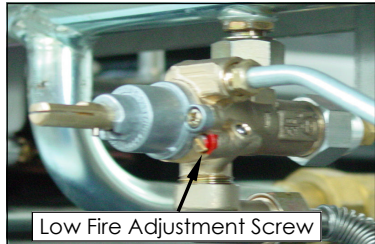
1. To adjust the open burner low fire adjustment, remove the gas control knobs from the front of the control panel. 

Low Fire Adjustment Screw
2. Adjust the low fire adjustment screw on the open burner gas control valves to obtain the desired flame size.

**NOTE:**

The 'Low Fire Screw' should be sealed with coloured paint on completion of the low fire adjustment.



### Aeration Adjustment

1. Check / adjust the main burner aeration gap. This gap should be set to the dimensions shown in the 'Gas Specification Tables' at the end of this section.

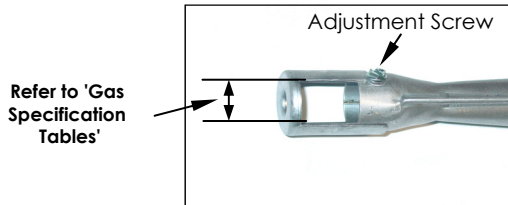

### Thermocouple Location

1. Check that the thermocouple is correctly located and that the gap between the thermocouple and the main burner is as shown in the diagram below.
2. Check that the thermocouple connection to the gas valve is tight.

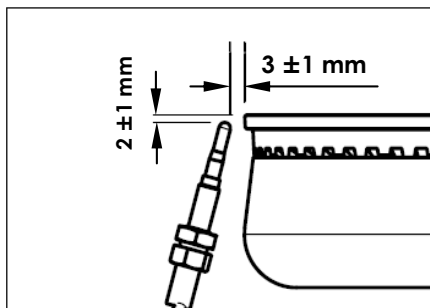

### Griddle

#### Main Burner

1. With the gas supply turned off at the main supply, remove the griddle plate section by lifting it straight off the Cooktop.
2. Remove the gas control heat shield from around the griddle burner, this is just a push in fit.

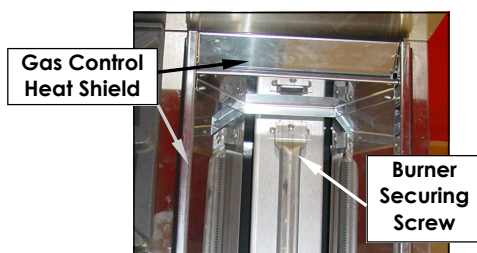

3. Disconnect the piezo igniter from the mounting bracket. (For access purposes).
4. Remove the main burner from the burner box by removing the securing screw at the end of the burner, this will reveal the main burner injector.

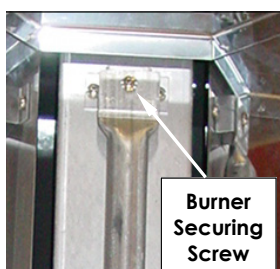

5. Remove and replace the main burner injector with correct size injector. Refer to the 'Gas Specifications' table at the end of this section, for correct injector sizes.
6. Refit the burner to the griddle burner box.
7. Refit the gas control heat shield to the griddle burner box.
8. Refit griddle plate section to the top of Cooktop.
9. Check the thermocouple connection the gas valve is tight.
10. Repeat Items 1 to 9 for all griddle main burners.
11. Turn 'ON' the gas supply at the mains, re-light the griddle burners and check the flame size on the 'LOW' flame position.

### Pilot Burner

1. Disconnect the pilot supply tube from the pilot burner.



2. Remove the existing pilot injector and replace with the correct size for the gas being used. Refer to the 'Gas Specifications' table at the end of this section, for correct injector sizes.
3. Re-connect pilot supply tube to the pilot burner.
4. Refit the piezo igniter to the mounting bracket.
5. Repeat Items 1 to 4 for all griddle pilot burners.

### Low Fire Adjustment

1. To adjust the griddle burner 'LOW' fire adjustment, remove the griddle gas control knobs from the front of the control panel.
2. Adjust the low fire adjustment screw on the griddle gas control valve only, to obtain the desired flame size.

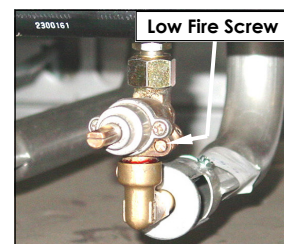

#### **NOTE:**

**The 'Low Fire Adjustment Screw' should be sealed with coloured paint on completion of the low fire adjustment.**

### Thermocouple Connection

1. Check that the thermocouple connection to the gas valve is tight.

### Oven

#### Main Burner - CR6 Model Only

1. Ensure that the gas supply is turned off at the main supply.
2. Open the oven door and remove the oven rack, oven tray and the flame baffle from inside the oven.
3. Remove the single screw securing the oven burner to the oven and pull out the main burner from the oven.

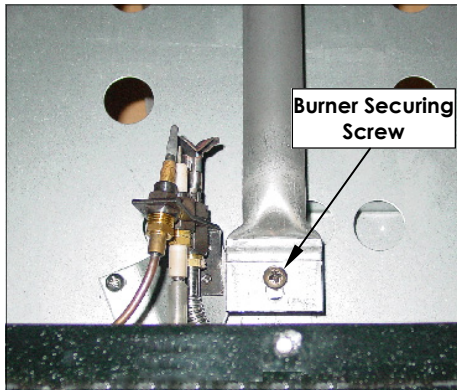

4. The main injector will now be exposed at the rear of the oven and can be unscrewed and removed using a 13 mm (1/2" A/F) spanner.

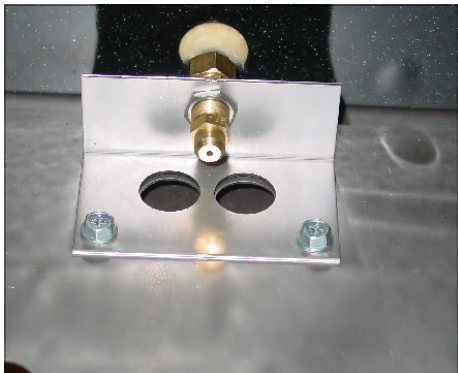

5. Remove the main burner injector and replace with the correct size injector. (Refer to the 'Gas Specifications' table at the rear of this section).
6. Refit the main burner to the oven and secure in position with the single screw.

#### Main Burner - CR9 Model Only

1. Ensure that the gas supply is turned off at the main supply.
2. Open the oven door and remove the oven rack, oven tray and the flame baffle from inside the oven.
3. Remove the 2 screws securing the oven burner bracket to the oven and pull the main burner out from the oven.

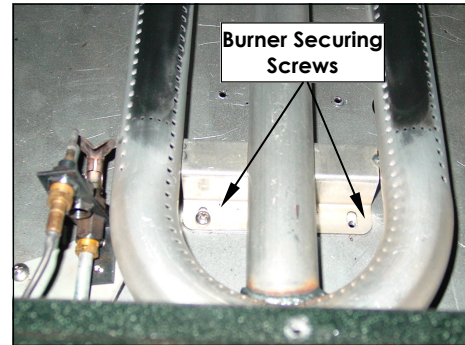

4. The main injector will now be exposed at the rear of the oven and can be unscrewed and removed using a 13 mm (1/2" A/F) spanner.

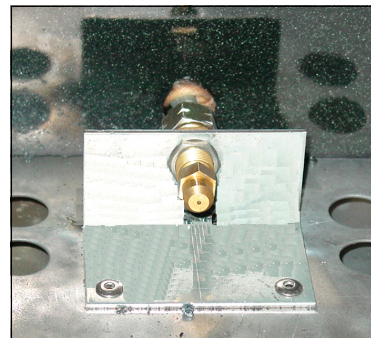

5. Remove the main burner injector and replace with the correct size injector. (Refer to the 'Gas Specifications' table at the rear of this section).
6. Refit the main burner to the oven and secure in position with the 2 screws.

### Pilot Burner

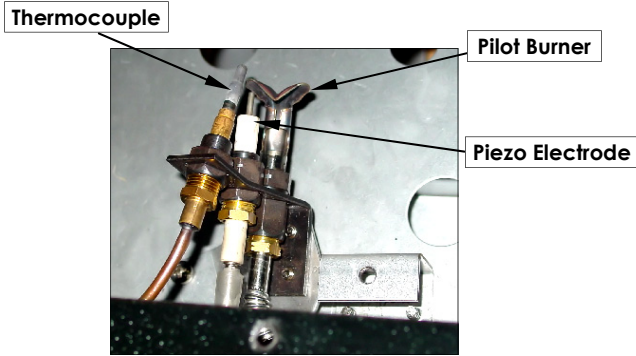

1. To remove the oven pilot injector, from inside the oven, unscrew and remove the thermocouple from the mounting bracket, for access purposes.
2. Unscrew and remove the Piezo Electrode from the mounting bracket, for access purposes.
3. Unscrew the hex nut holding the pilot supply tube to the rear of the pilot assembly.
4. Withdraw the pilot injector from the pilot assembly.
5. Replace the pilot injector with the correct sized injector for the gas type being used and re-connect the pilot supply tube to the pilot assembly.
6. Refit the and secure the piezo ignitor to the mounting bracket.
7. Refit the and secure the thermocouple to the mounting bracket.
8. Refit the flame baffle, oven tray and oven rack to the inside of the oven.

### Low Fire Adjustment

1. To change the thermostat 'Low Fire' screw for the gas type required, remove the gas control knobs from the control panel. The gas control knobs are a push fit onto the shaft of the gas control valves.
2. Unscrew the two screws on the front of the control panel and lift the panel away from the oven.
3. Unscrew and remove the old 'Low Fire' screw from the lower left hand front of the valve and fully screw in the new 'Low Fire' screw for the new gas type. (Refer to the 'Gas Specifications' table at the rear of this section for the correct low fire screw sizes).
4. Refit the control panel and secure with the securing screws.
5. Refit the gas control knobs to the spindles of the gas control valves.

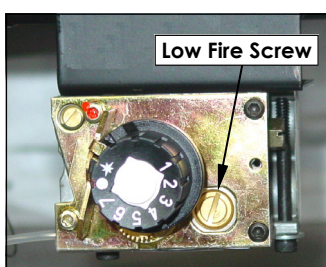

### Gas Regulator

**NOTE:**

The regulator supplied is convertible between Natural Gas and LP Gas, but its outlet pressure is fixed ex-factory and is NOT to be adjusted.

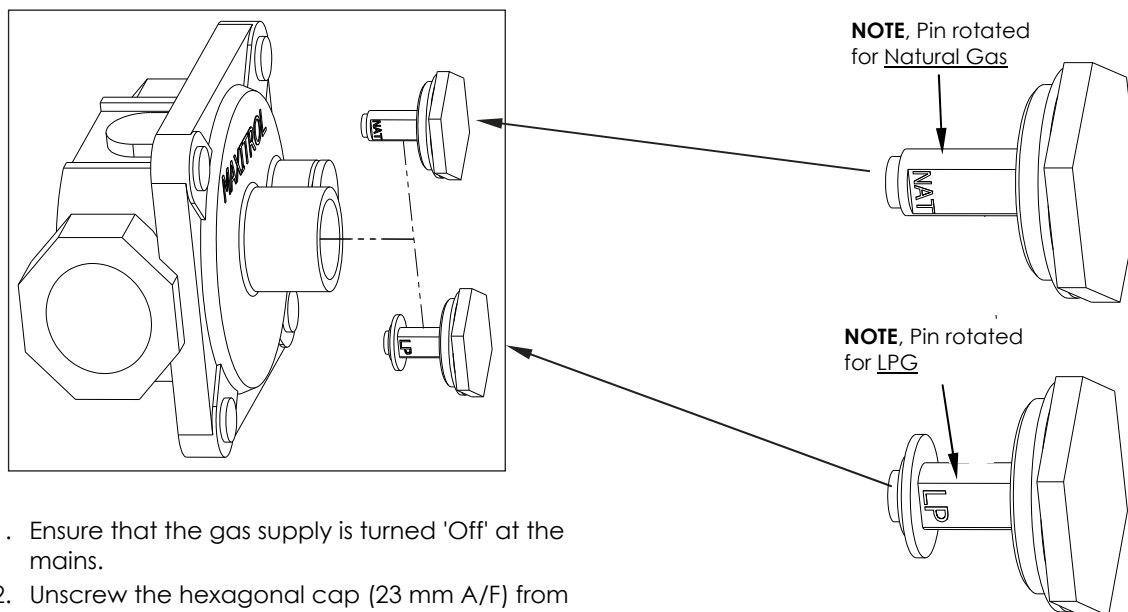

1. Ensure that the gas supply is turned 'Off' at the mains.
2. Unscrew the hexagonal cap (23 mm A/F) from the regulator.
3. Un-clip the plastic pin from the cap, reverse the pin and re-fit it back to the cap the correct way for the gas type to be used. **(Either 'LP' or 'NAT' should be visible on the flank of the pin once re-fitted to the cap).**
4. Screw the cap back into the regulator hand tight only.

- Oven Pilot Ignition.
- Oven Main Burner Thermostat.
- Turning the Oven to 'Stand-By' Mode.
- Oven 'Shut Down'.

### Gas Type Identification Label

On completion of the gas conversion, replace the gas type identification label located at:-

- The rear of the appliance, above the gas connection.
- Beside the rating plate.

3. Ensure any adjustments done to components that have the adjustments / settings sealed (e.g. paint sealed) are re-sealed.

### Commissioning

Before leaving the converted installation;

1. Check all gas connections for leakages using soapy water or other gas detecting equipment.

**NOTE:**

If for some reason it is not possible to get the appliance to operate correctly, shut off the gas supply and contact the supplier of this appliance.



**WARNING:**

**DO NOT USE A NAKED FLAME TO CHECK FOR GAS LEAKAGES.**



2. Check the following functions in accordance with the operating instructions specified in the 'Operation' section of this manual.
  - Lighting the Open Burners.
  - Lighting the Open Burners. (F - Flame Failure Option).
  - Lighting the Griddle.

### Gas Specifications

- Non-UK Only

|                           |           |                         | Natural Gas  | LP Gas (Propane)   |
|---------------------------|-----------|-------------------------|--|--|
| Open Burner               |           | Burner Injector         | Ø 2.10 mm  | Ø 1.30 mm  |
|                           |           | Low Fire Setting        | ¾ turn open c.c.w.   | ¼ turn open c.c.w.   |
|                           |           | Burner Aeration Setting | 16 mm open.  | 16 mm open.  |
| Griddle                   |           | Burner Injector         | Ø 2.00 mm  | Ø 1.25 mm  |
|                           |           | Low Fire Setting        | 5/8 turn open c.c.w.   | 3/8 turn open c.c.w.   |
|                           |           | Burner Aeration Setting | Fully open.  | Fully open.  |
|                           |           | Pilot Injector          | 0.35   | 0.23   |
| Oven                      | CR6 Model | Burner Injector         | Ø 2.40 mm  | Ø 1.40 mm  |
|                           |           | Low Fire Screw          | Ø 1.00 mm  | Ø 0.60 mm  |
|                           |           | Burner Aeration Setting | Fully open.  | 10 mm open.  |
|                           |           | Pilot Injector          | 0.35   | 0.23   |
|                           | CR9 Model | Burner Injector         | Ø 2.50 mm  | Ø 1.50 mm  |
|                           |           | Low Fire Screw          | Ø 1.50 mm  | Ø 0.95 mm  |
|                           |           | Burner Aeration Setting | Fully open.  | Fully open.  |
|                           |           | Pilot Injector          | 0.35   | 0.23   |
| Supply Pressure           |           |                         | 1.13 - 3.40 kPa  | 2.75 - 4.50 kPa  |
| Burner Operating Pressure |           |                         | 1.0 kPa (*)  | 2.6 kPa (*)  |
| Gas Regulator Cap Screw   |           |                         |  |  |

- UK Only

|                           |           |                         | Natural Gas (G20)   | Propane (G31)   |
|---------------------------|-----------|-------------------------|---|---|
| Open Burner               |           | Burner Injector         | Ø 1.90 mm   | Ø 1.20 mm   |
|                           |           | Low Fire Setting        | ¾ turn open c.c.w.  | ¼ turn open c.c.w.  |
|                           |           | Burner Aeration Setting | 16 mm open.   | 16 mm open.   |
| Griddle                   |           | Burner Injector         | Ø 2.00 mm   | Ø 1.25 mm   |
|                           |           | Low Fire Setting        | 5/8 turn open c.c.w.  | 3/8 turn open c.c.w.  |
|                           |           | Burner Aeration Setting | Fully open.   | Fully open.   |
|                           |           | Pilot Injector          | 0.35  | 0.23  |
| Oven                      | CR6 Model | Burner Injector         | Ø 2.40 mm   | Ø 1.40 mm   |
|                           |           | Low Fire Screw          | Ø 1.00 mm   | Ø 0.60 mm   |
|                           |           | Burner Aeration Setting | Fully open.   | 10 mm open.   |
|                           |           | Pilot Injector          | 0.35  | 0.23  |
|                           | CR9 Model | Burner Injector         | Ø 2.50 mm   | Ø 1.50 mm   |
|                           |           | Low Fire Screw          | Ø 1.50 mm   | Ø 0.95 mm   |
|                           |           | Burner Aeration Setting | Fully open.   | Fully open.   |
|                           |           | Pilot Injector          | 0.35  | 0.23  |
| Supply Pressure           |           |                         | 20 mbar   | 37 mbar   |
| Burner Operating Pressure |           |                         | 10 mbar (*)   | 28 mbar (*)   |
| Gas Regulator Cap Screw   |           |                         |  |  |

### Replacement Parts List

#### IMPORTANT:

Only genuine qualified replacement parts should be used for the servicing and repair of this appliance. The instructions supplied with the parts should be followed when replacing components.

For further information and servicing instructions, contact your nearest qualified service branch (contact details are as shown on the reverse of the front cover of this manual).

When ordering spare parts, please quote the part number and the description as listed below. If the part required is not listed below, request the part by description and quote model number and serial number which is shown on the rating plate.

### Open Burners

|        |                          |                    |                                   |
|--------|--------------------------|--------------------|-----------------------------------|
| 230014 | Pot Stand.               |                    |                                   |
| 230088 | Pot Stand Support.       |                    |                                   |
| 230631 | Front Burner Assy.       |                    |                                   |
| 230632 | Rear Burner Assy.        |                    |                                   |
| 230288 | Burner Cap.              |                    |                                   |
| 230637 | Gasket Burner Assy.      |                    |                                   |
| 037210 | Injector                 | (Nat. Gas)         | Ø 2.10 mm (Non-UK).               |
| 037130 | Injector                 | (LP Gas [Propane]) | Ø 1.30 mm (Non-UK).               |
| 037190 | Injector                 | (Nat. Gas [G20])   | Ø 1.90 mm (UK Only).              |
| 037120 | Injector                 | (Propane [G31])    | Ø 1.20 mm (UK Only).              |
| 018680 | Gas Control Pintossi 20N |                    | (Standard Burners Only).          |
| 231560 | Gas Control Pintossi 20S |                    | (Flame Failure '-F' Models Only). |
| 019428 | Thermocouple - (320 mm). |                    |                                   |
| 230671 | Thermocouple - (500 mm). |                    |                                   |
| 230606 | Knob - Open Burner.      |                    |                                   |

### Griddle

|        |                                 |                                 |            |
|--------|---------------------------------|---------------------------------|------------|
| 014105 | Griddle Burner.                 |                                 |            |
| 230213 | Griddle Reflector Assy.         |                                 |            |
| 227403 | Gas Control Valve.              |                                 |            |
| 230608 | Knob - Griddle.                 |                                 |            |
| 032200 | Injector                        | (Nat. Gas)                      | Ø 2.00 mm. |
| 032125 | Injector                        | (LP Gas [Propane])              | Ø 1.25 mm. |
| 019215 | Pilot Burner (Fully Assembled). |                                 |            |
| 026488 | Pilot Injector                  | (Nat. Gas)                      | 0.35.      |
| 019217 | Pilot Injector                  | (LP Gas [Propane])              | 0.23.      |
| 019428 | Thermocouple - (320 mm).        |                                 |            |
| 230586 | Piezo Ignitor.                  |                                 |            |
| 228047 | Piezo H.T. Lead.                |                                 |            |
| 230289 | Grease Tray                     | (1 per 300 mm Griddle Section). |            |
| 230059 | Griddle Plate 300 mm.           |                                 |            |
| 230084 | Griddle Plate 600 mm.           |                                 |            |
| 230091 | Griddle Plate 900 mm            | (CR9 Only).                     |            |

### Oven

|        |                              |
|--------|------------------------------|
| 022446 | Oven Burner (CR6).           |
| 230441 | Oven Burner (CR9).           |
| 235493 | Eurosit Gas Control Valve.   |
| 018682 | Thermocouple (1500 mm Long). |
| 230586 | Piezo Igniter.               |
| 232691 | HT Lead 1600 mm.             |
| 233954 | Oven Rack (CR6).             |
| 230556 | Oven Rack (CR9).             |
| 233948 | Oven Tray (CR6).             |
| 230462 | Oven Tray (CR9).             |
| 011005 | Ball Catch Assy.             |
| 230487 | Top Striker Plate.           |
| 010254 | Bottom Striker Plate.        |
| 227469 | Door Handle.                 |

#### CR6 Model

|        |                |                    |            |
|--------|----------------|--------------------|------------|
| 032240 | Injector       | (Nat. Gas)         | Ø 2.40 mm. |
| 032140 | Injector       | (LP Gas [Propane]) | Ø 1.40 mm. |
| 022409 | Low Fire Screw | (Nat. Gas)         | Ø 1.00 mm. |
| 234038 | Low Fire Screw | (LP Gas [Propane]) | Ø 0.60 mm. |

#### CR9 Model

|        |                |                    |            |
|--------|----------------|--------------------|------------|
| 032250 | Injector       | (Nat. Gas)         | Ø 2.50 mm. |
| 032150 | Injector       | (LP Gas [Propane]) | Ø 1.50 mm. |
| 022408 | Low Fire Screw | (Nat. Gas)         | Ø 1.50 mm. |
| 022407 | Low Fire Screw | (LP Gas [Propane]) | Ø 0.95 mm. |

#### CR6 / CR9 Models

|        |                          |                    |          |
|--------|--------------------------|--------------------|----------|
| 026488 | Pilot Injector (CR6/CR9) | (Nat. Gas)         | 0.35 mm. |
| 019217 | Pilot Injector (CR6/CR9) | (LP Gas [Propane]) | 0.23 mm. |

### General

|        |                    |
|--------|--------------------|
| 230138 | Drip Tray (CR6).   |
| 230139 | Drip Tray (CR9).   |
| 229674 | Rear Roller Assy.  |
| 234059 | Leg Assy (150 mm). |

### Regulator

|        |  |
|--------|--|
| 228531 | Regulator (Natural Gas/LP Gas [Propane] Convertible) ¾" BSP F/F. |
|--------|--|

### Gas Conversion Kits

#### - Non UK Only:

| Model | Gas Type to Convert to: |          |
|-------|-------------------------|----------|
|       | LPG (Propane)           | Nat. Gas |
| CR6   | 234043                  | 234042   |
| CR9   | 231573                  | 231572   |

#### - UK Only:

| Model | Gas Type to Convert to: |                |
|-------|-------------------------|----------------|
|       | Propane (G31)           | Nat. Gas (G20) |
| CR6   | 234046                  | 234047         |
| CR9   | 232244                  | 232245         |

