



# AMH80 & AMH80D

# User & Installation Guide

JUNE.2021

REF:IT3810HALDDM

**All spares available from**



The Engine Shed  
Top Station Road  
Brackley  
NN13 7UG  
Tel: 0845 1308060  
Fax: 01280 845345  
Web: [www.caterparts.com](http://www.caterparts.com)

**Copyright Notice:** All rights reserved. No parts of this manual may be reproduced in any form without express written permission of Maidaid-Halcyon (A trading name of Buttress Group Ltd)

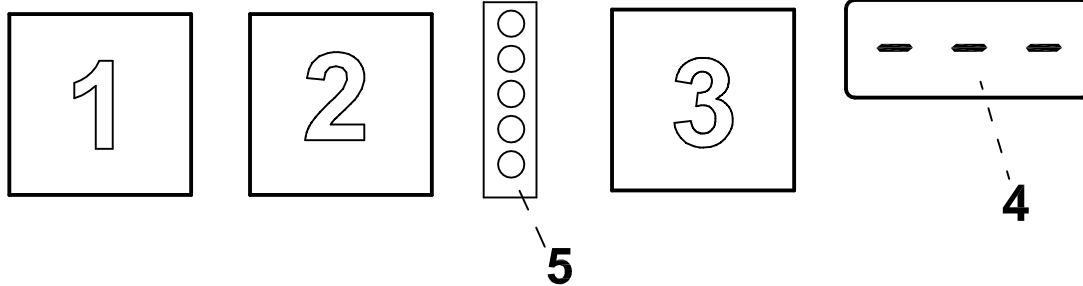

**Fig.1**

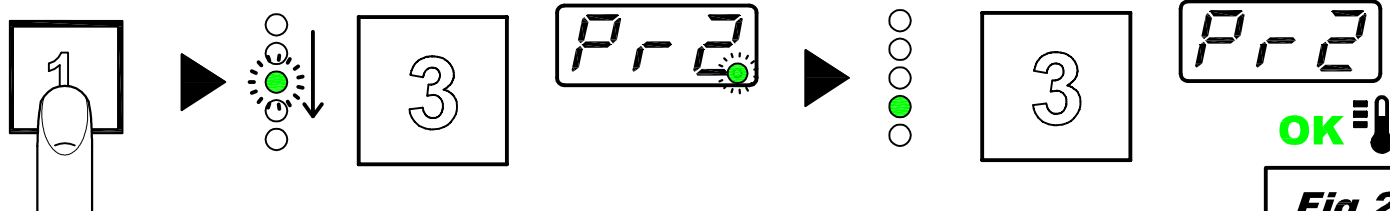

**Fig.2**

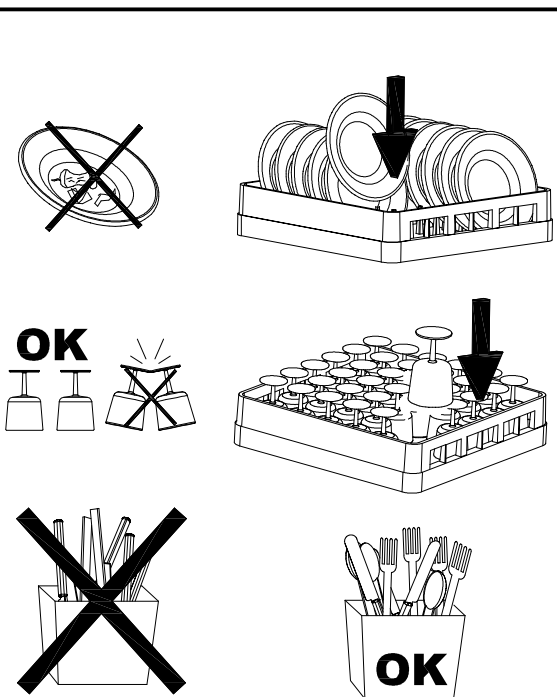

**Fig.3**

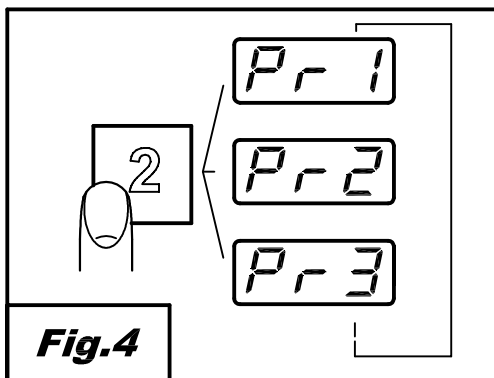

**Fig.4**

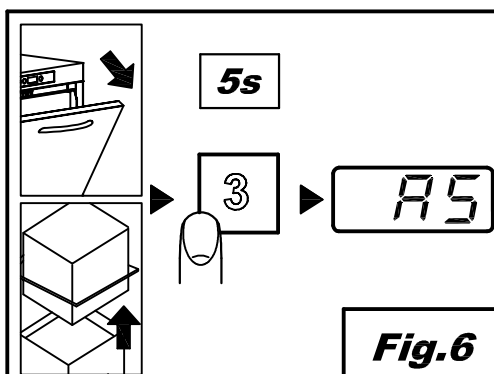

**Fig.6**

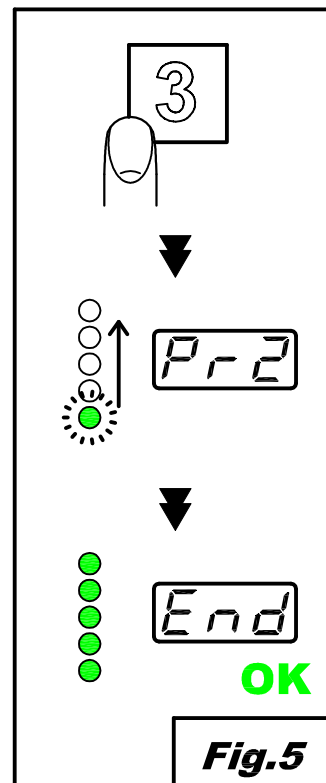

**Fig.5**

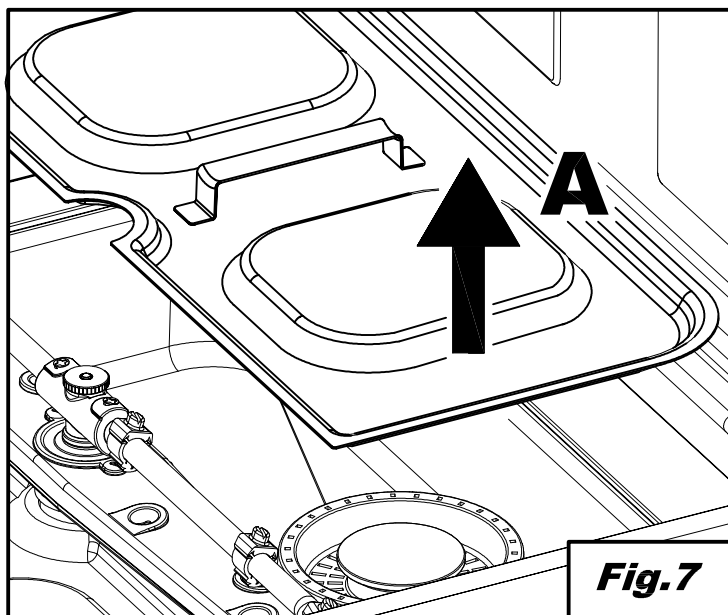

**Fig.7**

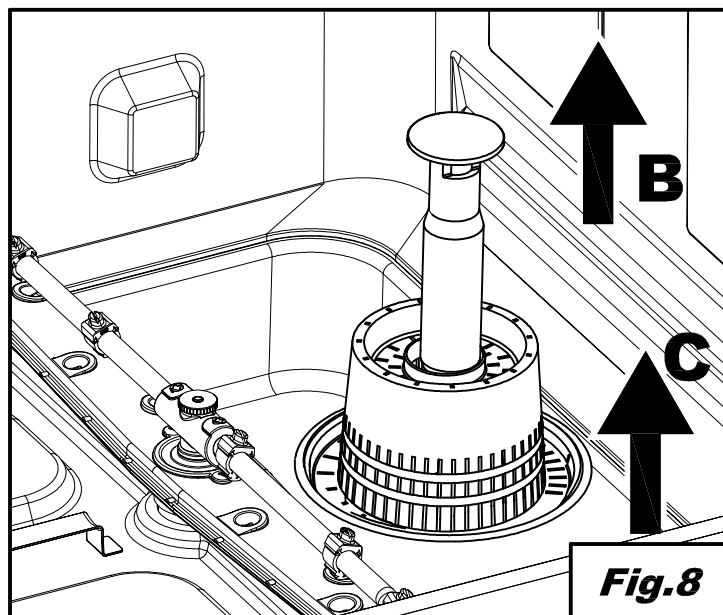

**Fig.8**

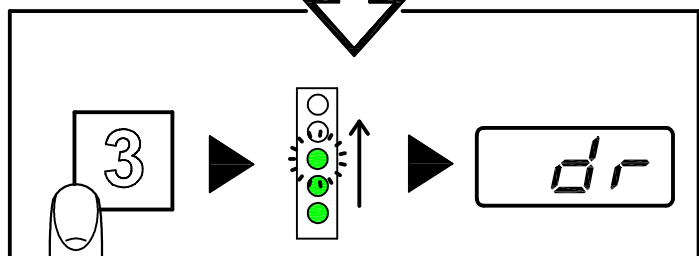
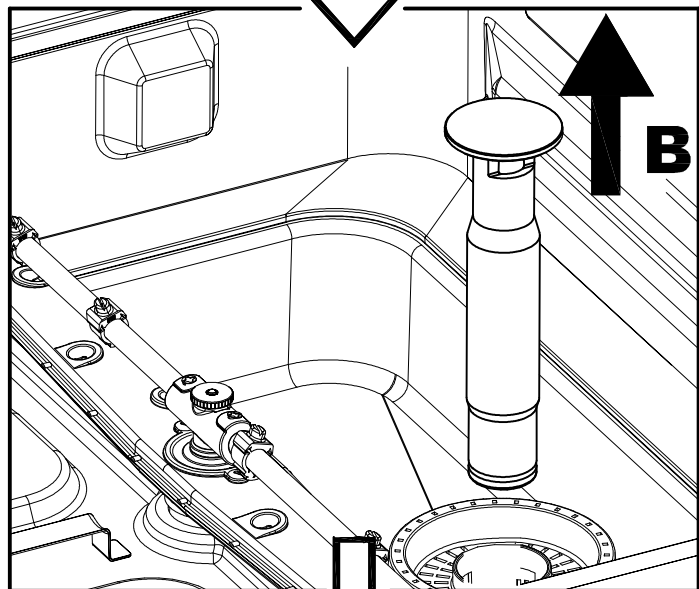
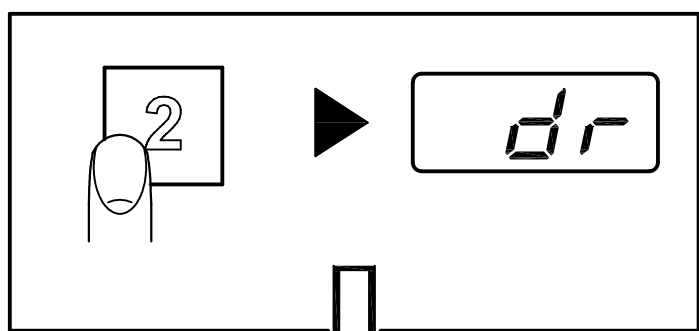

Fig.9

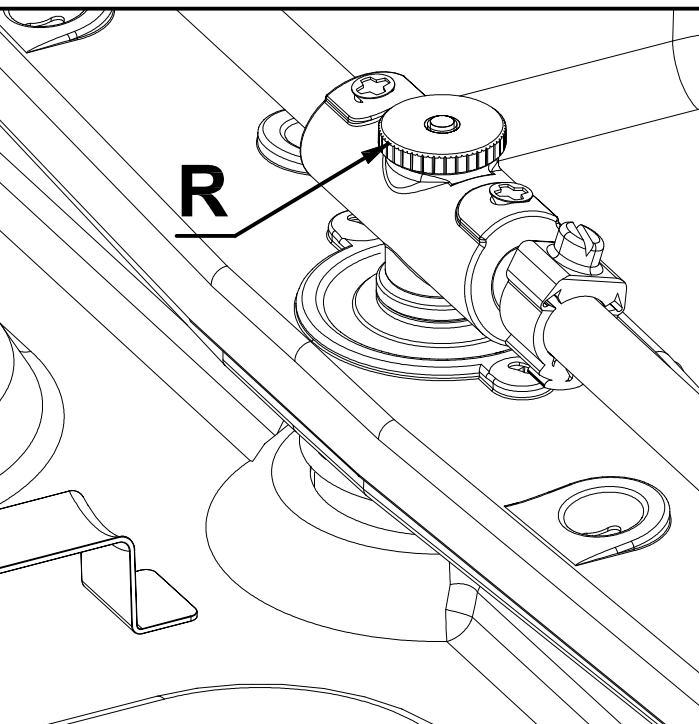
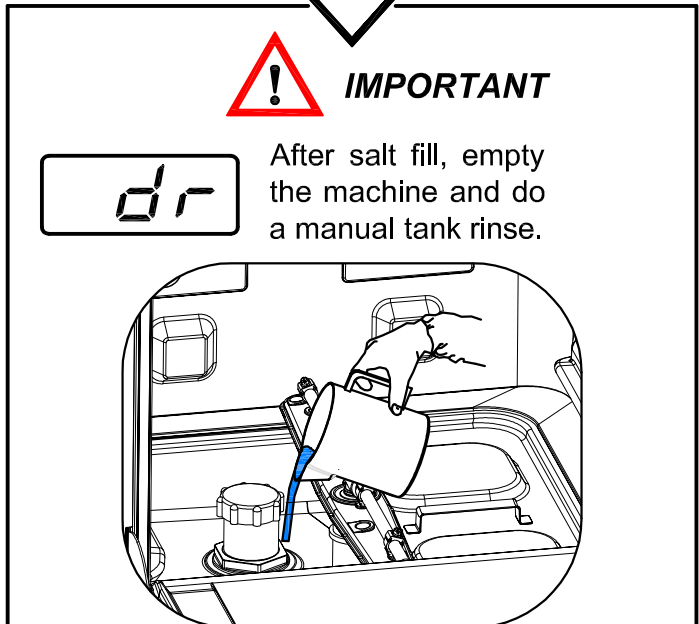
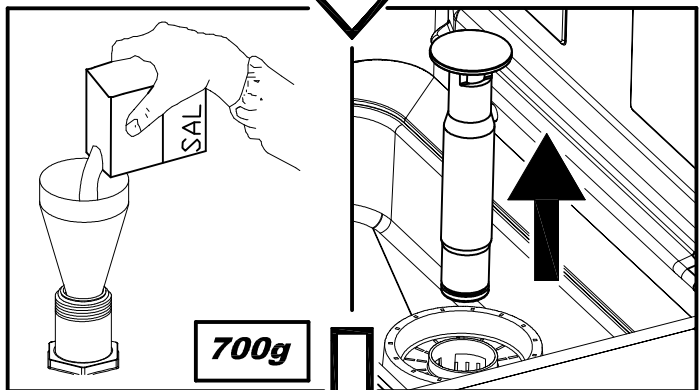
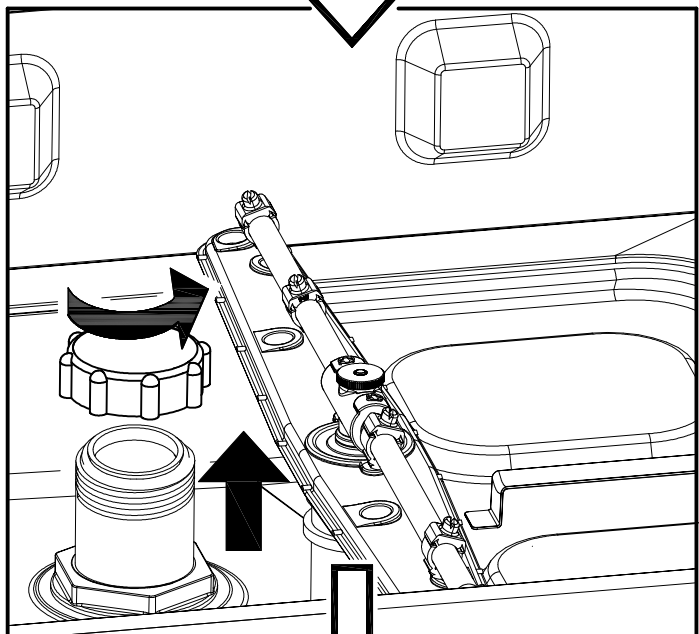
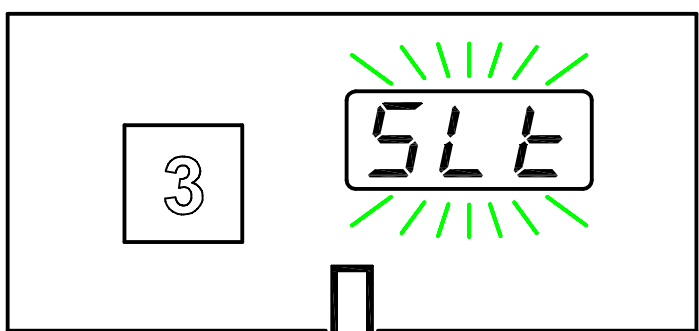

Fig.10



**!** IMPORTANT



After salt fill, empty the machine and do a manual tank rinse.

Fig.11

## CONTENTS

<b>CHAP 1</b>	<b>RISKS AND IMPORTANT WARNINGS</b> .....	<b>2</b>
1.1	NORMAL OPERATING CONDITIONS .....	3
<b>CHAP 2</b>	<b>PREFACE</b> .....	<b>4</b>
<b>CHAP 3</b>	<b>INSTALLATION</b> .....	<b>4</b>
3.1	UNPACKING .....	4
3.2	POSITIONING.....	4
3.3	ELECTRICAL CONNECTION.....	5
3.4	WATER CIRCUIT HOOKUP .....	6
3.5	CONNECTION TO THE DRAIN LINE.....	6
3.6	RINSE AID AND DETERGENT.....	6
<b>CHAP 4</b>	<b>USING THE MACHINE</b> .....	<b>7</b>
4.1	KEY AND SYMBOLS .....	7
4.2	SWITCHING THE DISHWASHER ON .....	7
4.3	FILLING THE RACK .....	7
4.4	CYCLE SELECTION AND START-UP .....	7
4.5	CONTINUOUS WASHING (*OPTIONAL) .....	8
4.6	AUTOMATIC CYCLE START-UP.....	8
4.7	REMOVING THE INTEGRAL FILTER .....	8
4.8	EMPTYING THE DISHWASHER.....	8
	4.8.1 <i>Appliances with no drain pump</i> .....	8
	4.8.2 <i>Appliances with drain cycle (*optional)</i> .....	8
4.9	TURNING THE DISHWASHER OFF .....	8
4.10	RESIN REGENERATION (*OPTIONAL).....	8
4.11	DISPLAYING INFORMATION .....	9
4.12	LIST OF VIEWABLE MESSAGES .....	9
4.13	END OF SHIFT.....	9
<b>CHAP 5</b>	<b>MAINTENANCE</b> .....	<b>10</b>
5.1	GENERAL RULES .....	10
5.2	CLEANING.....	10
5.3	CLEANING THE FILTER UNIT .....	10
5.4	CLEANING THE ARMS .....	10
<b>CHAP 6</b>	<b>SELF DIAGNOSTICS</b> .....	<b>11</b>
<b>CHAP 7</b>	<b>SETTINGS</b> .....	<b>12</b>
7.1	NUMBER OF CYCLES TO REGENERATE RESINS .....	13
<b>CHAP 8</b>	<b>SCRAPPING</b> .....	<b>13</b>
<b>CHAP 9</b>	<b>ENVIRONMENT</b> .....	<b>13</b>

*In legal terms, the manufacturer reserves the property of this document. It is forbidden to reproduce it or divulge it with any means without prior written authorisation.  
The manufacturer reserves the right to introduce changes in order to achieve the improvements it deems necessary without prior notice.*



Read the instruction manual carefully before starting the machine. The warnings contained in the manual provide important information on safety and installation, use and maintenance. Failure to observe the instructions in the enclosed documentation may compromise the safety of the appliance and immediately voids the warranty.

## Chap 1 RISKS AND IMPORTANT WARNINGS

- This appliance is intended solely for the use for which it was designed. Any other use is improper and therefore hazardous.
- The specialised technician responsible for installing the appliance must instruct the user on its operation and any attendant safety measures, including practical demonstrations.
- Only the manufacturer or an authorised service centre with qualified staff may work on the machine, even in case of malfunction, using only original spare parts.
- Always disconnect or isolate the machine from its power and water supplies before servicing, repairing or cleaning it.
- The machine may **NOT** be used by persons untrained in its use.
- The appliance may be used by children aged at least 8 years old or persons with reduced physical, sensory or mental capacities, or with no experience or knowledge, provided they are supervised or after they have received training in the safe use of the appliance.
- Children must not play with the appliance.
- Cleaning and maintenance by the user must not be performed by unsupervised children.
- The machine must **NOT** be kept powered up when not in use.
- If the machine is not fitted with a plug or other device for completely disconnecting all contacts, these disconnection devices must be incorporated in the power supply, in compliance with the installation rules.
- If the power cable is damaged, it must be replaced by the manufacturer or an authorised technical assistance service, or in any case by a person with similar qualifications, to prevent all associated risks.
- The screw on the appliance marked with the IEC 60417 standard symbol 5021 represents the equipotential connection.
- **NEVER** open the machine quickly if it has not completed its cycle.
- **NEVER** use the machine with the guards installed by the manufacturer removed.
- **NEVER** use the machine to wash objects of any form, size or material not guaranteed to be machine-washable or not in good condition.
- **NEVER** use the machine or any of its assemblies as steps or support for persons, property or animals.
- **NEVER** overload the open door of front-loading machines, which is rated only to support the basket loaded with dishes.
- **NEVER** place your bare hands in the wash solution.

- **NEVER** overturn the machine after it has been installed.
- If you notice any malfunction or fluid leak, immediately disconnect the power supply and shut off the water supply.
- Do not install the dishwasher in the vicinity of heat sources over 50°C.
- **NEVER** leave the dishwasher exposed to the weather (rain, direct sunlight, etc.)
- The dishwasher may not be installed outdoors without proper cover.
- Never start a wash programme without the overflow in the tub, as applicable.
- Never place magnetic objects in the vicinity of the machine.
- Do not use the top of the machine as a table or support.
- The installer is responsible for checking that the grounding system is fully operational.
- At the end of testing, the installer must issue a written declaration stating that the machine has been installed and tested in accordance with established legislation and good practice.
- **DO NOT** change the position or tamper with the elements of the machine, as this could compromise the machine safety.
- Noise pressure level according to EN ISO 4871
  - LpA Max = 55db Kpa=2.5db for undercounter versions
  - LpA Max = 65db Kpa=2.5db for hood versions
  - LpA Max = 76db Kpa=1.5db for utensil washer versions
- Max inlet water temperature: 50°C
- Max inlet water pressure: 4bar (400kPa)
- Appliance designed for permanent connection to the water supply
- Do not clean the appliance with steam or water jets.
- Max loading height
  - On the ground in the versions with overflow
  - Maximum height 1 m in versions with discharge pump

### **1.1 Normal operating conditions**

Ambient temperature: 40°Cmax /4°Cmin (average 30°C)  
Altitude : up to 2000 metres  
Relative humidity : Max 30% at 40°C / max 90% at 20°C

## Chap 2 PREFACE

**Warnings:**

Keep all documentation in the vicinity of the appliance; make it available to the technicians and operators charged with operating it and keep it in good condition in a safe place, along with extra copies for frequent reference

**The operator must read, understand and familiarise himself with the contents of this manual before working on or with the appliance.**

The appliance is intended solely for professional heavy duty dishwashing applications and must be installed, operated and serviced only by qualified persons according to the manufacturer's instructions.

**Warranty:**

The manufacturer is not liable for any damage or injury resulting from failure to observe the instructions or improper use of the machine

Failure to observe the instructions in the enclosed documentation may compromise the safety of the appliance and immediately voids the warranty

Installation and repair by unauthorised technicians and the use non-original spare parts immediately void the warranty.

**Storage:**

Transport and storage: -10°C to 55°C with peaks up to 70°C (for no longer than 24 hours)

## Chap 3 INSTALLATION

Proper installation is essential to the good operation of the appliance. Some of the data required for installation of the appliance are given on the nameplate on its RH body panel, and a copy is included on the cover page of this manual.

**The appliance may only be installed by qualified persons authorised to do so.**



**For Australia and New Zealand this machine must be installed in accordance with AS/NZS3500.1**

**3.1 Unpacking**

Check the condition of the packaging, and note any evident damage on the shipping bill. Remove the packaging and check that the appliance is in good condition; immediately report any damage to the reseller and the shipping agent by fax or registered letter with return receipt. If the damage is such as to compromise the safety of the appliance, do not install or operate it until it has been inspected by a qualified technician.



**The packaging (plastic bags, expanded polystyrene, nails, etc. ) are hazardous and must not be left within the reach of children or pets.**

**3.2 Positioning**

- Check that there are no objects or materials in the installation area which may be damaged by the steam emitted by the appliance during operation, or if there are, make sure they are properly protected.
- Before positioning the appliance, set up the electrical power supply, water supply and drain connections.
- For flush-mounting single panel machines, leave a space of at least 10 mm between the machine walls and the adjacent surfaces.
- The floor or build-in unit must be rated to support the weight of the appliance
- To ensure that it is stable, level the appliance with its four feet.
- The appliance is intended for fixed installation only; any other approaches must be agreed with and approved by the manufacturer.

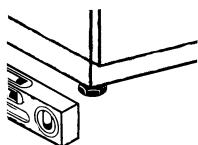

- Remove the protective film from its body panels before operating the dishwasher.

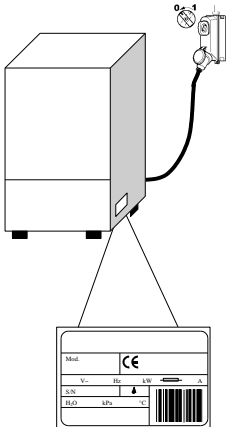

### 3.3 Electrical connection

- The power supply must be fitted with a omnipolar circuit breaker (master power switch) to break all contacts including neutral, with a contact gap of at least 3 mm and thermal cutout or fuses, which must be set or rated to the power indicated on the machine's nameplate.
- The master power switch must be fitted to the power line in the vicinity of the installation and may be connected to only one machine at a time.
- The mains voltage and frequency must match the nameplate ratings.
- The installation must include a grounding system conforming with established electrical safety legislation, to protect the operator and the appliance itself

- This appliance conforms to EN/IEC 61000-3-11 certification if the system impedance  $Z_{sys}$  is less than or equal to  $Z_{max}$  in the point of interface between the user's supply system and the public system. The installer or appliance user is responsible for checking that the appliance is connected exclusively to a supply with system impedance  $Z_{sys}$  less than or equal to  $Z_{max}$

	$Z_{max}$
<b>Utensil washers</b>	0.21 $\Omega$
<b>Hood</b>	0.24 $\Omega$
<b>Undercounter</b>	0.41 $\Omega$

- The power cable, which must be exclusively type H07RN-F with current capacity at 60°C on the cable:
  - Three-phase machine
    - -5x2.5 mm<sup>2</sup> up to 20 A
    - -5x4 mm<sup>2</sup> up to 30 A
    - -5x6 mm<sup>2</sup> up to 38 A
    - -5x10 mm<sup>2</sup> up to 54 A
  - Single-phase machines
    - -3x1.5 mm<sup>2</sup> up to 16 A
    - -3x2.5 mm<sup>2</sup> up to 25 A
- Must not be stretched or crushed during normal operation or routine maintenance.
- The appliance must also be connected to an equipotential system, connected by a screw marked by the symbol 5021 - IEC 60417. 
- The equipotential cable must have a cross section of 10 mm<sup>2</sup>.
- Respect the polarities indicated in the wiring diagram.
- For further information, refer to the wiring diagram.



**Do not use multi-sockets, adapters, cables of an inadequate cross section or type or with extensions not conforming to established electrical installation regulations.**



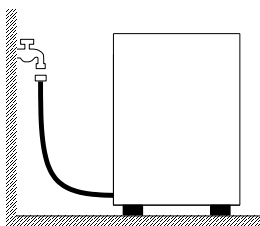

### 3.4 Water circuit hookup

The appliance must be connected to its water supply with a flexible hose. A shut off valve (cock) must be installed between the water supply line and the appliance's solenoid valve. The cock must be close to the appliance.

- The water supply, temperature and pressure **must be compatible** with the ratings shown on the technical data plate on the machine.
- Make sure that the water supply flow rate is no less than 20 l/min
- If the water hardness is greater than 14 °f (8 °dH), we recommend using an internal water softener. If the water hardness is greater than 35 °f (19.5 °dH), install an external water softener upline of the solenoid valve
- For machines without water softener: if the water hardness is greater than 14 °f (8 °dH), install an external water softener upline of the solenoid valve.
- If the water has a very high residual concentration of high conductivity minerals, we recommend installing a demineralisation system.
- Machines intended for use with desalinated water or in any case with high sodium chloride concentration must be ordered specifically, as they require specific construction materials
- Do not supply fully demineralised water to machines with a heat recovery unit with batteries with copper pipes. In this case, request the version with batteries with stainless steel pipes.

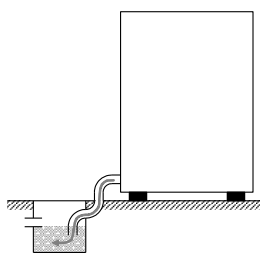

Free drain

### 3.5 Connection to the drain line

- The drain line must consist of a free drain sump with siphon suited to the flow capacity of the drain hose supplied with the appliance. The hose must be able to reach the sump without stretching, restriction, folding, crushing, pressing or forcing in any way.
- The tub drains under gravity, so the drain sump must be lower than the machine's base.

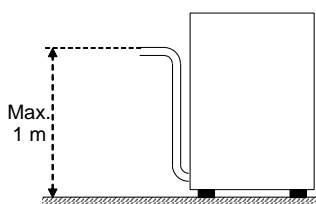

With pump (available on request)

- if the drain is not lower than the base of the appliance, you can use the version with drain pump (available on request).
- In this case, the drain connection may be no higher than 1 m.
- Always check that the drain works properly and is not blocked.
- Any other solution must be approved by the manufacturer in advance.

### 3.6 Rinse aid and detergent

- The rinse aid and detergent are dispensed by the machine's integral dispenser (depending on model).
- The dose is set by the installer in relation to the hardness of the water, and he also calibrates the dispensers themselves.
- Before calibrating them, fill the dispenser supply tubes with their respective product.
- The units are calibrated with the adjuster screws, or directly with the control panel (as applicable).
- The level of fluid in the container must be sufficient for priming; do not allow it to drain completely or top it up with corrosive or impure product.

**NEVER use CHLORINE or HYPOCHLORITE based detergents.**

We recommend installing an automatic detergent dispenser.

**Chap 4 USING THE MACHINE**

**4.1 Key and symbols**

Referring to *Fig.1*:

1	ON/OFF BUTTON	4	DISPLAY INFORMATION
2	PROGRAMME SELECTION BUTTON	5	STATUS BAR (LED)
3	START BUTTON		

**4.2 Switching the dishwasher on**

Referring to *Fig.2*

- Turn on the main power switch and open the external water tap.
- Check the presence of the overflow.
- Press **ON/OFF (1)**.
- The point on the display flashes until the level is reached.
- The **STATUS BAR (5)** lights up from the top downwards to indicate that the dishwasher is heating up.
- When the working temperature is reached, the central led on the **STATUS BAR (5)** stays on, fixed.
- The optimal wash conditions have been reached.

**4.3 Filling the rack**

Referring to *Fig. 3*, to ensure the correct operation of the dishwasher follow the rules described below:

- Use a suitable rack, fill without overloading and without overlapping the dishes.
- Always wipe the dishes before placing in the dishwasher; do not put dishes with dry or solid residues in the washer.
- Place the empty dishes in the rack facing downwards.
- Place plates and the like in the sloping rack, with the inner surface facing upwards.
- Place the cutlery in the cutlery basket, handle end down.
- Do not place silver and stainless steel cutlery in the same cutlery basket as this will turn the silver brown and may corrode the steel.
- Wash the dishes immediately after use, in order to prevent any residue from hardening and sticking on them.
- Use only solid, dishwasher-proof dishes.

**4.4 Cycle selection and start-up**

- Press the **PROGRAMME SELECTION** button (2) repeatedly to select a wash cycle that is suitable for the dishes to be washed; the display will show the cycle number chosen (**Fig. 4**).
- To run the programme, press **START (3)**; the **STATUS BAR (5)** starts to flash, increasing from the bottom upwards to indicate the progression of the cycle.
- When the cycle is completed, all the leds will come on, fixed (**Fig.5**).
- For rapid drying, remove the rack from the machine as soon as the cycle finishes.
- To stop a wash cycle early, press **START (3)**.

***N.B. In hood versions, after the first work cycle the automatic start is automatically enabled; the subsequent cycles will be enabled automatically when the hood is closed. This operating mode is marked on the display by "AS".***

#### 4.5 Continuous washing (\*optional)

- This is an extended cycle; the time varies according to the model.
- The cycle duration may be varied as required by pressing **START (3)** during the wash cycle, to interrupt the wash and start the rinse phase.

#### 4.6 Automatic cycle start-up

This function is used to make the chosen cycle start automatically when the door is closed. To enable, proceed as follows (**Fig.6**):

- With the appliance on and the door open, press and hold (for at least five seconds) **START (3)** until **AS** appears on the display.
- To disable the function, with the door open press **START (3)** again for five seconds.

#### 4.7 Removing the integral filter

- Move the washing and rinsing arms at right angles to the edge of the door (**Fig.7**).
- Lift each semi-filter by the relative handle.

#### 4.8 Emptying the dishwasher

##### 4.8.1 Appliances with no drain pump

- Switch the dishwasher off.
- Remove the integral filter (**Fig.7A**).
- Pull up and remove the overflow pipe (**Fig.8B**).
- Wait for the tub to empty completely.
- If necessary, extract the tub filter and clean (**Fig.8C**).

##### 4.8.2 Appliances with drain cycle (\*optional)

- If present, remove the integral filter (**Fig.7**).
- If present, remove the overflow by pulling upwards (**Fig. 9**).
- Close the door.
- Select the cycle **dr**
- Press **START (3)** to start the cycle.
- The machine runs a drain cycle with self-cleaning (\*where foreseen) and then switches off.
- If necessary, extract the tub filter and clean (**Fig.8C**).

#### 4.9 Turning the dishwasher off

- Press **ON/OFF (1)**, on the **DISPLAY (4)** the central segments will light up, indicating that the machine is powered.

#### 4.10 Resin regeneration (\*optional)

In machines fitted with water softener, when the warning 'SLT' appears you should add salt to the relative container; proceed as follows:

- Remove the basket from the machine.
- Remove the integral filter (**Fig. 7**).
- Unscrew the cap on the salt container (**Fig. 11**).
- Pour in approx. 700g of large-grain kitchen salt, using the funnel supplied. (when filling for the first time, fill the tank firstly with water)
- Close the container firmly.

- Rinse the area around the salt cap by hand and run a self-cleaning cycle to avoid any risk of corrosion.
- The 'SLT' warning will disappear after a few minutes.

The warning **rEG** on the display indicates that the machine is running a resin regeneration cycle, needed to ensure the correct operation of the water softener; while this warning is shown, the cycles run could be longer than usual.

**N.B. Do not switch off the machine if a regeneration cycle is underway**

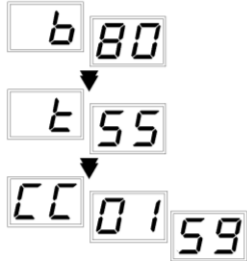





**4.11 Displaying information**

With the dishwasher on, press **PROGRAMME SELECTION (2)** for five seconds, in sequence the following are shown:

- "t" wash temperature
- "b" rinse temperature
- "CC" wash cycles carried out during the life of the dishwasher.

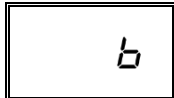
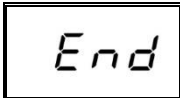
**4.12 List of viewable messages**

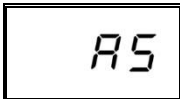
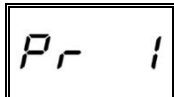
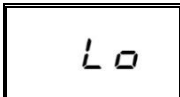
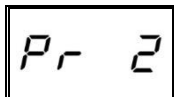
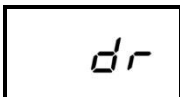
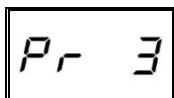
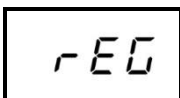
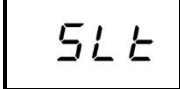
 Door open	 Number of cycles carried out
 Rinse temperature	 End of cycle
 Wash temperature	 Automatic start enabled
 Short wash	 Continuous wash
 Medium wash	 Final drain
 Long wash	 Regeneration cycle or request
	 No salt in the softener

**4.13 End of shift**

- At the end of the day always drain the machine as described in the section Machine draining.
- Disconnect the power supply by means of the main switch and close the external water cock.
- Perform routine maintenance and clean the machine as described in the section Maintenance.
- If possible, leave the door ajar to prevent bad odours building up inside the machine.

## Chap 5 MAINTENANCE

### 5.1 General rules



Before doing any maintenance, completely drain out all water, shut off the power supply and close the water supply cock.

Do not use water under pressure - it can damage the electrical equipment.

Only wash the body panelling when it is cold, using only product specifically designed for steel.

If there is a risk of ice forming, drain the water from the boiler and wash pump.

### 5.2 Cleaning

To keep the machine in good working order, it must be maintained regularly as explained below. We recommend periodically running a sanitising treatment with suitable non-corrosive commercial products.

### 5.3 Cleaning the filter unit

Run this procedure at the end of the day or when you see the filters are dirty:

1. Remove and clean the baskets.
2. Empty out the tub as explained in "Machine draining".
3. Remove and carefully clean all the filters.
4. Do not use abrasive products to clean the tub.
5. Restore all removed parts when finished.

### 5.4 Cleaning the arms

The wash and rinse arms are easily removed in order to clean their nozzles and prevent blockage/encrustations.

Proceed as follows ( *Fig.10* ):

- Undo nut **R** and remove the arms.
- Wash all parts under a jet of running water and clean the nozzles thoroughly, using a toothpick or pointed tool if necessary.
- Clean the arm rotation pins inside the machine and the wash and rinse water drainage area.
- Restore the arms and check that they rotate freely.

**Chap 6 SELF DIAGNOSTICS**

The machine is equipped with a self-diagnosis system that registers and warns of a number of malfunctions.

<b>Fault</b>		<b>Description and possible remedies</b>
	<b>Er 01</b>	<b>No rinsing.</b> The rinsing cycle was not completed correctly. Make sure that the rinsing nozzles are clean.
	<b>Er 02</b>	<b>No drainage.</b> The water was not drained or drained incorrectly. Check that the drain pipe is not bent or crushed and that the siphon and filters are not blocked. In machines fitted with an overflow pipe, remove this before starting the drainage cycle.
	<b>Er 03</b>	<b>Rinsing temperature reset fault.</b> The boiler temperature did not reset in the set time during the washing cycle. Switch the machine off and then on and run a new cycle.
<b>SAFE</b>	<b>Er 04</b>	<b>Water filling in tank fault.</b> Make sure the pipes are connected correctly, and that the water tap is open. Where foreseen, check the presence of the overflow. Switch the dishwasher off and then on and fill again.
	<b>Er 05</b>	<b>Tank thermometer fault. (Probe open)</b> The machine does not read the tank temperature value. Switch the dishwasher off and then on.
	<b>Er 06</b>	<b>Tank thermometer fault. (Probe short circuited)</b> The machine does not read the tank temperature value. Switch the dishwasher off and then on.
	<b>Er 07</b>	<b>Boiler thermometer fault. (Probe open)</b> The machine does not read the boiler temperature value. Switch the dishwasher off and then on.
	<b>Er 08</b>	<b>Boiler thermometer fault. (Probe short circuited)</b> The machine does not read the boiler temperature value. Switch the dishwasher off and then on.
	<b>Er 09</b>	<b>Boiler loading time out:</b> boiler not filled. Impossible to carry out rinse cycle. Check that the water tap is open. Switch the dishwasher off and then on and run a new cycle.
	<b>Er 21</b>	<b>Insufficient rinse:</b> the right amount of rinsing did not take place; make sure the rinse nozzles are clean. The error does not stop machine operation.
	<b>Er 22</b>	<b>Tank temperature reset fault:</b> The tank temperature did not reset in the set time during the washing cycle. Switch the machine off and then on and run a new cycle.
<b>SAFE</b>	<b>Er 5F</b>	<b>Electro-mechanical safety device:</b> the boiler or tub safety thermostats have cut in, or the tub safety pressure switch has been triggered.
<b>SAFE</b>	<b>Er 5L</b>	<b>Level safety switch:</b> Incorrect water level in the tank.
<p><b>WARNING! Switching the dishwasher off and then on again "resets" the signals, if after carrying out the instructions given the problem persists, contact an Authorised Service Centre.</b></p>		



The following settings should only be configured by a qualified technician.

The parameters listed below can be set during installation of afterwards, accessing the settings menu as follows:

- Machine in standby with door open.
- Press buttons 2 and 3 together (cycle selection and **START**) for 5 seconds and enter the key **CH 12** (buttons 2 and 3 to change the parameter, 1 to confirm).
- Then press button 1 (**ON/OFF**) repeatedly to scroll through the following headings, enabling and/or changing them using buttons 2 and 3 (the modified parameter is memorised without being confirmed). The list of parameters may vary according to the type of dishwasher.

	<b>Language</b>	Language selection
<b>b</b>	<b>Boiler Temperature</b>	Boiler temperature settings for programmes. In the versions with atmospheric boiler (rinse pump) there are different settings for each programme (b1 – b2 – b3)
<b>t</b>	<b>Tank Temperature</b>	Tub temperature regulation for programmes. Rinse pump versions have different settings for each programme (t1 – t2 – t3)
<b>tH</b>	<b>Thermo - Stop</b>	Enabling the Thermostop function, which guarantees the correct rinse temperature.
<b>ES</b>	<b>Energy Saving</b>	Enabling the Energy Saving function, which guarantees energy savings when the dishwasher is on but not in use.
<b>dn</b>	<b>Detergent Pump</b>	Manual operation of detergent doser
<b>bn</b>	<b>Rinse Aid Pump</b>	Manual operation of rinse aid doser
<b>rn</b>	<b>Manual Rinse</b>	Manual operation of the rinse pump
<b>dt</b>	<b>Dosage Detergent</b>	Detergent dosing time
<b>bl</b>	<b>Dosage Rinse Aid</b>	Rinse aid dosing time
<b>dH</b>	<b>Water Hardness</b>	Setting the supply water hardness (dishwashers with water softener): enter the values given in the table below
<b>CC</b>	<b>Set Number Service Cycles</b>	Cycle counter setting and activation to enable the Service alert for an external water softener. The Service alert can be cancelled by holding pressed all 3 buttons with the machine off and the door open.
<b>AA</b>	<b>Autostart Autoenabling</b>	Automatic enabling of automatic starting

Once all necessary parameters have been set, to exit and memorise any changes simply press and hold button 1 for a few seconds until the on-line dashes appear.

**7.1 Number of cycles to regenerate resins**

Set the hardness level of the water supply **dH** in the settings menu following the instructions given in the following table:

Measured hardness		dH	Measured hardness		dH
°fr	dGH	n°	°fr	dGH	n°
0 ÷ 20	0 ÷ 11	1	41 ÷ 45	23 ÷ 25	6
21 ÷ 25	12 ÷ 14	2	46 ÷ 50	26 ÷ 28	7
26 ÷ 30	15 ÷ 17	3	51 ÷ 55	29 ÷ 31	8
31 ÷ 35	17 ÷ 20	4	56 ÷ 60	31 ÷ 34	9
36 ÷ 40	20 ÷ 22	5			

**Chap 8 SCRAPPING**



Our machines do not contain materials requiring special handling. (Applicable in the EU and countries with sorted waste disposal)

The mark applied to the product or its documentation indicates that it must not be scrapped with domestic waste when it reaches the end of its service life. To prevent damage to the environment or health risks due to improper scrapping, keep this product separate from other waste and recycle it so as to promote sustainable use of materials.

Domestic users are requested to contact their reseller or local authority for information on sorted waste disposal and recycling for this type of product.

Corporate users are requested to contact their supplier and check the terms and conditions of the purchase contract.

The product may not be scrapped together with other commercial waste.

	Recycling symbol	Symbols	Object	Material	%
Recyclable directly			Sheet	Steel	80
			Cardboard packaging	PAP	
			Wooden pallet	ISPM15	
			Plastic parts	PP, PP+FV	
Compounds		W E E E	Motors	Assemblies	20
			Electric parts		
			Electronic parts		
			Rubber parts	EPDM	

**Chap 9 ENVIRONMENT**

**RESPECT FOR THE ENVIRONMENT**

Proper use of the dishwasher can improve its environmental footprint, if the following simple rules are observed:

- Only wash full baskets.
- Switch the dishwasher off when not using it.
- Keep the machine closed when it is in standby.
- Use wash programmes suited to the amount of soiling.
- Supply the machine with hot water, if gas heated.
- Make sure the drains flow into a suitable sewer.
- Do not exceed the recommended dose of detergent.

The manufacturer reserves the right to modify the electrical, technical and aesthetic features of this appliance and replace any of its parts without notice, as he deems necessary to offer a reliable product with a long service life and advanced technology.





# INSTRUCTION MANUAL FOR DISHWASHERS