

Troubleshooting & Service for EL/VS Systems



60 Hz

Balboa's Patented M7 Technology

TOPSIDE CONTROL PANEL

The control panel activates functions at the touch of a button. Each function will echo from the circuit board to the LCD in a corresponding manner. The panel will also display diagnostic messages that enable the service technician to easily troubleshoot the system.



ML700 Top Side Panel

M7 TECHNOLOGY

M7 is a patented Balboa technology that uses two sensors inserted at the opposite ends of the heater element to determine flow, dry fire conditions, etc. The two sensors located within the heater housing compare the inlet water temperature with the outlet water temperature. It works no matter which direction the water flows through the heater.

The sensors in combination with specific software allow the spa to be controlled without the use of external pressure switches, flow switches, or temperature sensors.



Panel Construction

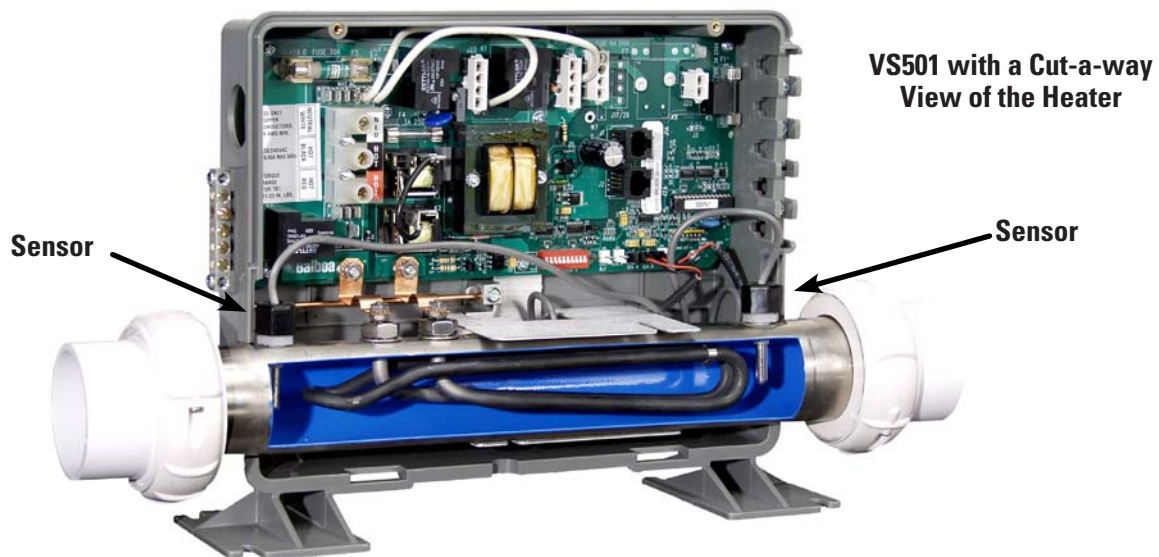

VS501 with a Cut-a-way View of the Heater

Table of Contents

Balboa's Patented M7 Technology	.2
Balboa Service Tools and Parts Checklist	.5
Important Information -- Product Identification	.6
Troubleshooting & Servicing Spa and Electrical Equipment	.7
G.F.C.I. Troubleshooting	.8
<i>If Correct Wiring is Verified</i>	<i>.8</i>
<i>To Disconnect the Heater</i>	<i>.8</i>
Voltage Checks: Breaker Box, G.F.C.I. & System Box	.9
Wiring Checks	14
Spa Behavior -- Start-up Information	15
<i>Priming Mode</i>	<i>15</i>
<i>Heater Start up Information</i>	<i>15</i>
Diagnosing M7 Topside Control Panels	16
<i>Checking the System Power Input Fuse</i>	<i>19</i>
ML Series Panels -- For Use with EL and GL Systems	21
ML900 Panel Operation	22
ML700 Panel Operation	23
ML550, 551, 554 Panel Operation	24
ML200, 240, 260, 400 Panel Operation	28
VL Series Panels -- For use with VS and GS Systems	32
VS/GS Panel -- 300 & 500 Series and Operation	34
EL and GL Series Mach 3 -- Persistent Memory & Power Up	38
<i>EL - GL, about Persistent Memory</i>	<i>38</i>
<i>Power Up Display Sequence, Software ID</i>	<i>38</i>
VS-GS Persistent Memory with VL Panels	39
Testing the Circuit Board Output	40
<i>Balboa's Quick Test™ Test Kit</i>	<i>40</i>
<i>To Use the Balboa Quick Check</i>	<i>40</i>
Testing the Sensor Set	41
Changing a System Circuit Board	42
<i>How to Remove a System Circuit Board</i>	<i>42</i>
<i>How to Replace a System Circuit Board</i>	<i>42</i>
Removing the Heater Assembly from a Spa System	43
Panel Message Reference Guide	44

Diagrams (in alphabetical order)

300/300F/500Z Series Panel34
500DZ Series Panel34
500SZ Series Panel34
Balboa QuickCheck™ Part No. 7000240
Ground-Fault Circuit Interrupter/Circuit Breaker (G.F.C.I.)	8
120 Volt Residential Wiring Schematic with G.F.C.I..10
240 Volt Residential Wiring Schematic with G.F.C.I..12
Ground in System Enclosure	7
Heater Element Specifications Are Shown on the Heater Tube Label	6
ML260, ML240, ML20028
ML400.28
ML550.24
ML551.24
ML554.24
ML700 Top Side Panel	2
Recommended Parts For Service Calls	5
Service Tools Required	5
“Molex” Type, ML/GL Connector	6
On Every System, an Identification Label Is Placed on top of the Casing	6
On Every System, a Wiring Diagram Is Placed Inside the Door	6
Panel Construction	2
“Phone Plug” RJ Type, VL/GS Connector	6
“Phone Plug” RJ Type, VL/VS Connector32
Terminal Block 1 & F5 Fuse on a VS500Z Board19
VS500 Board42
VS501 with a Cut-a-way View of the Heater	2

Balboa Service Tools and Parts Checklist

Service Tools Required

- Ammeter (50A)
- Balboa Six-in-one Screwdriver
- Digital Multi-meter
- Padlock (to lock electrical disconnect during service)
- Pliers: Slip Joint & Needle nose
- Precision Thermometer - Digital Fever Type
- Quick Check™ Test Kit
- Silicone Tube
- Small Wire Cutters
- Two 3/8" Open End Wrenches (one wrench should be ground down to 5/32" [0.156"] thickness in order to access the nut between the heater strap and heater element connector)



COMMON FUSES USED

- 30074 FUSE 1 AMP FAST BLOW GLASS
- 30075 FUSE 5 AMP FAST BLOW GLASS
- 30122 FUSE 10A BLOWER
- 30595 FUSE 10A POWER INPUT
- 30076 FUSE 15 AMP FAST BLOW CERAMIC
- 30596 FUSE 15A POWER INPUT
- 30142 FUSE 20A POWER INPUT
- 30123 FUSE 20A PUMP
- 30137 FUSE 25A POWER INPUT
- 21447 FUSE 25A POWER INPUT HIGH SURGE
- 30136 FUSE 30A POWER INPUT



Recommended Parts For Service Calls

- Extra Board(s)
- Extra Panel(s)
- Fuses
- Jumpers
- Heater Assembly



- MORE COMMON BOARDS:**
22972 BOARD BARE VS500 (shown)
21998 BOARD BARE GL2000
27116 BOARD BARE EL5000



53649 ML700



Heater Assembly

Troubleshooting & Servicing Spa and Electrical Equipment

HIGH VOLTAGE CAN SERIOUSLY INJURE OR KILL!

ONLY EXPERIENCED TECHNICIANS SHOULD SERVICE THIS EQUIPMENT.

DO NOT remove the protective covers from any electrical enclosure, or attempt to service any related electrical device, unless you are a qualified electrician or service professional.



DANGER

Risk of electric shock. Before working with any electrical connections, make certain that the Main Power breaker from the house breaker box has been turned off.



WARNING

All electrical work must be performed by a qualified electrician and must conform to all local codes.



IMPORTANT

Due to the danger of severe electrical shock, locate all power disconnects before servicing a spa. Precautions must be taken whenever working with breaker boxes, G.F.C.I.'s, or service disconnects.

- Always refer to the wiring diagram which is included with each system on the inside of the system box cover. Use this diagram for voltage measurement points, and for proper reconnection of wires.



A terminal marked "GROUND" is provided within the System Control Center enclosure. To reduce the risk of electrical shock, connect this terminal to the grounding terminal of the electric supply panel with a continuous green insulated copper wire equivalent in size to the circuit conductors supplying this equipment, but no smaller than #12 AWG.



Ground in System Enclosure



Safety Tips

- Keep children and pets away.
- Be aware of your surroundings. Standing in water while repairing a spa puts you at serious risk.
- Avoid working in cramped or crowded conditions.
- Consider placing a padlock on the service panel to lock out anyone who might power up the system.

G.F.C.I. Troubleshooting

Keep in mind that a majority of G.F.C.I. tripping problems can be attributed to incorrect wiring. G.F.C.I. troubleshooting usually finds the problem.

IF CORRECT WIRING IS VERIFIED

- Check to see if the proper G.F.C.I. is installed.
- Check the label in the system box near TB1 to determine the maximum amperage draw for the system.
- Be sure the G.F.C.I. is rated for more amperage than the system will draw.
- For a 240 V dedicated system, a 2-pole G.F.C.I. with no load neutral is acceptable.
- For a 120/240 V system, the G.F.C.I. must include a load neutral out.
- If the white load neutral wire is routed from the G.F.C.I. neutral bar directly to TB1 in the system box, then the G.F.C.I. will trip when a 120 V device is activated.
- For a detailed wiring checklist, please review the previous segment of this manual on proper G.F.C.I. wiring or the G.F.C.I. manufacturer's instructions.
- If the wiring is correct and the G.F.C.I. will not reset, then unplug the pump and try to reset the G.F.C.I.
- If the G.F.C.I. trips again, then unplug the blower and reset the G.F.C.I.. If the G.F.C.I. continues to trip, then do the same procedure for the ozone generator.
- If the G.F.C.I. stops tripping after you unplugged one of the spa's components, turn off the power to the spa then plug in each component except the one that tripped the G.F.C.I.
- Power up the system. If the G.F.C.I. no longer trips, then you have correctly identified the problem. Repair or replace the component as instructed by the spa manufacturer.
- If you have unplugged all of the spa's components and the G.F.C.I. still doesn't reset, then the problem is most likely a ground fault in the heater.

WARNING: THE OWNER SHOULD TEST AND RESET THE G.F.C.I. ON A REGULAR BASIS TO VERIFY ITS FUNCTION.

TO DISCONNECT THE HEATER

- First, turn off the main circuit breaker, then remove both heater straps or wires from the system heater output, not the heater itself.
- After restoring the power, try to reset the G.F.C.I. again. If it no longer trips after the system calls for heat, then replace the heater.
- If the G.F.C.I. still trips, look for pinched or shorted wires at the transformer. Make sure that the screws that attach the transformer to the system box have not pinched or damaged the insulation of the transformer wires.
- If the transformer wires are undamaged, check for any other pinched wires. Refer to the wiring diagram to verify the correct wiring of the control system.
- If everything looks to be in perfect working order, then the G.F.C.I. may be defective.

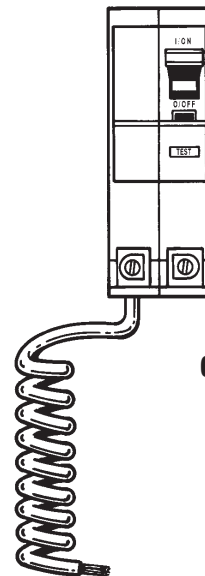

Ground-Fault Circuit Interrupter/Circuit Breaker (G.F.C.I.)

Voltage Checks: Breaker Box, G.F.C.I. & System Box

When checking for proper voltage, keep in mind that the acceptable voltage range is $\pm 10\%$ of the recommended voltage.

Acceptable voltage when 120 V is specified is between 108 and 132 V.

Acceptable voltage when 240 V is specified is between 216 and 264 V.

Diagrams are on the following pages.

Voltage Verification - Most G.F.C.I. Problems Are Due To Low Voltage



IMPORTANT:

IF THE VOLTAGE IS NOT WITHIN THE ACCEPTABLE RANGE, CALL AN ELECTRICIAN OR THE LOCAL ELECTRIC COMPANY TO DIAGNOSE THE PROBLEM.

CHECK THE VOLTAGES AT:

- 1. Breaker Box Voltage Check**
- 2. G.F.C.I. Line-In Voltage Check.**
- 3. G.F.C.I. Load Out Voltage Check**
- 4. System Box Check At Tb1**

120 VOLT SYSTEMS - 120V \pm 10% - 108V - 132V
240 VOLT SYSTEMS - 240V \pm 10% - 216V - 264V

No More Than 2% (5 Volt AC) Difference Between Voltage at the Breaker Panel And Voltage at the System.

• **CHECK UNDER PEAK LOADS -- TWO TYPES OF PEAK LOADS**

1. Spa System Peak Loads - Pumps, Heater, Blower & Light On
2. Household Peak Loads - May Be In Afternoon On Hot Day
Use Recording Meter If Possible - Records Max & Min Volts

• **MIDSTREAM CONTROL SYSTEM RELATED ISSUES**

Communication Between Topside & System Board In Most Systems

Press Button - Message Sent To System Board

System Board Performs - Message Sent Back To Topside & Relay Opens Or Closes

LED or Icon Is Turned On or Off - Hear Or See Relay Open Or Close

In Most Cases, If This Happens, There Is No Problem With The Topside Panel Or System Board

• **EXAMPLE - SPA LIGHT IS NOT WORKING - 2 OR 3 EASY STEPS !**

1. Press Light Button
Light LED or Icon Turns ON, But Spa Light Is NOT ON
Topside & Board Are Good, Check Downstream
Light LED or Icon Is NOT ON
Topside Or System Board May Be Bad, Continue
2. Plug In Spare Topside Panel - Easier To Check For Bad Topside
Light LED or Icon Now Turns ON
Original Topside Is Bad - R&R Topside Panel
Light LED or Icon Is NOT ON
Original Topside Is Good, Do Not Replace
System Board Is Bad - R&R System Board
3. Spa Light Is Still NOT ON - Check Downstream
Same Procedure For Other Functions
Jets, Blower, Heater, Time, Program, Mode, Etc.

Diagrams Are On The Following Pages.

120 Volt Residential Wiring Schematic with G.F.C.I.

House Breaker Box

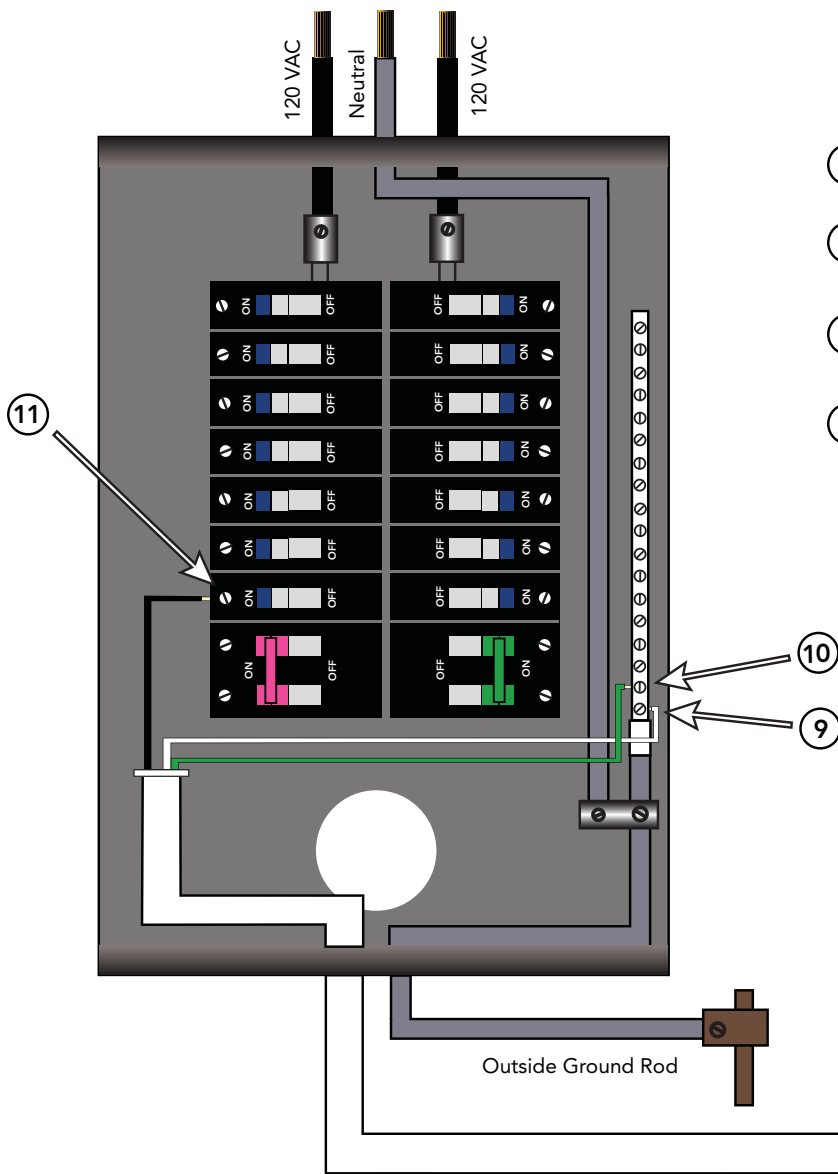

G.F.C.I Breaker Box

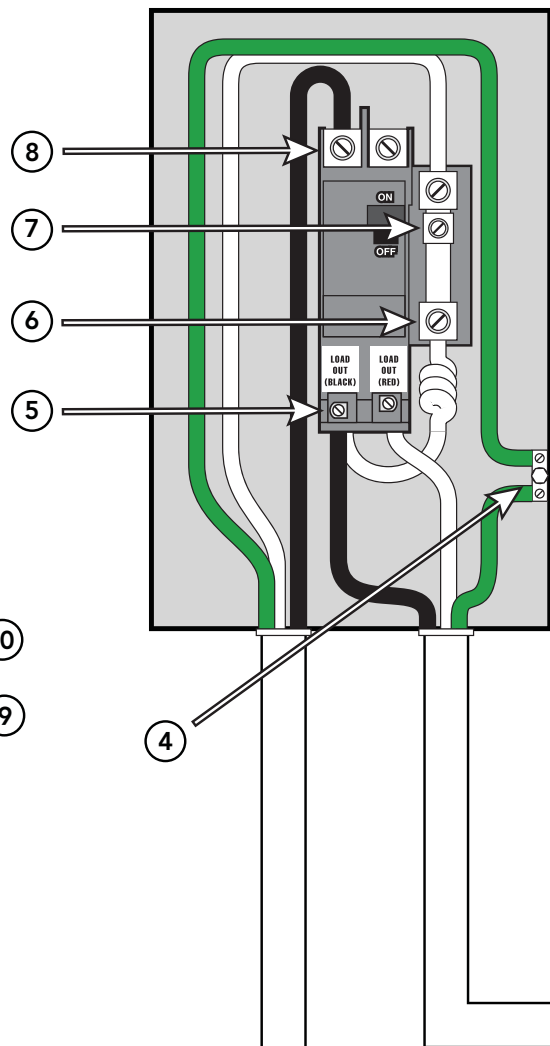

Correct Voltage	When Probes Are Placed Across
0v	[2 - 3] [4 - 6] [4 - 7] [5 - 8] [9-10]
108V - 132V	[1 - 3] [4 - 5] [4 - 8] [5 - 6] [5 - 9] [6 - 8] [7 - 8] [9 - 11][10 - 11]

Spa System Box 120VAC Service

Bottom view of G.F.C.I

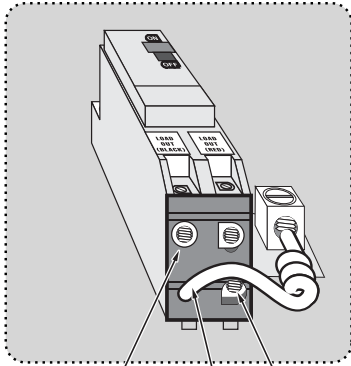

Black (Hot) White White

5

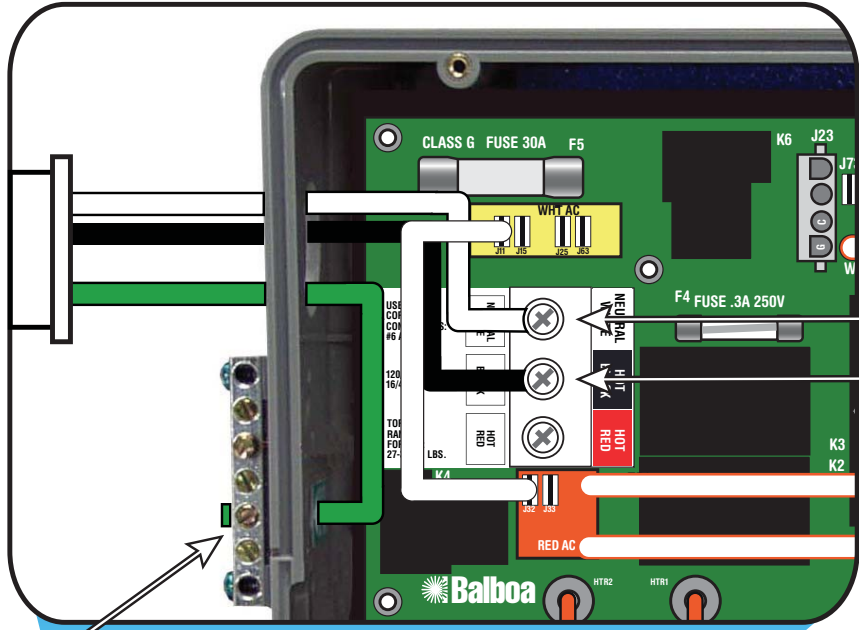

3

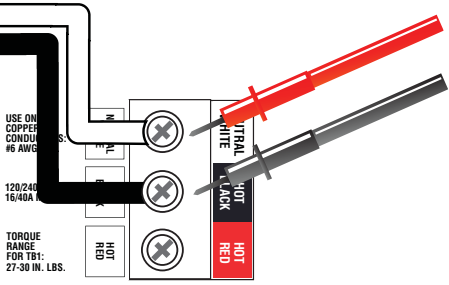
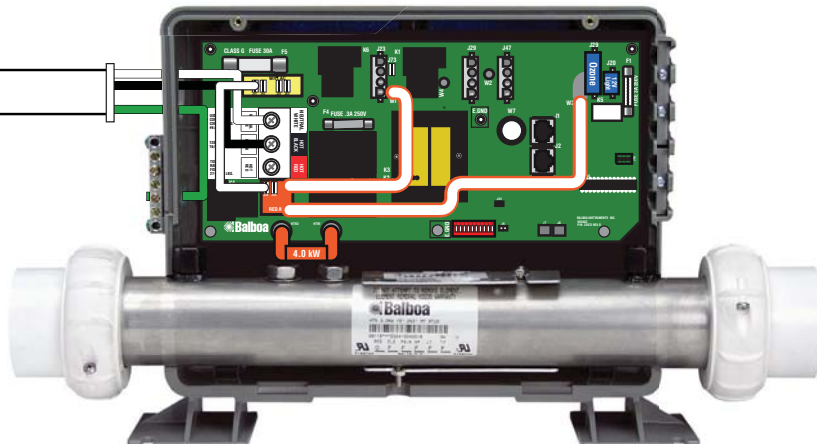

Test for Voltages by placing probes on these locations

240 Volt Residential Wiring Schematic with G.F.C.I.

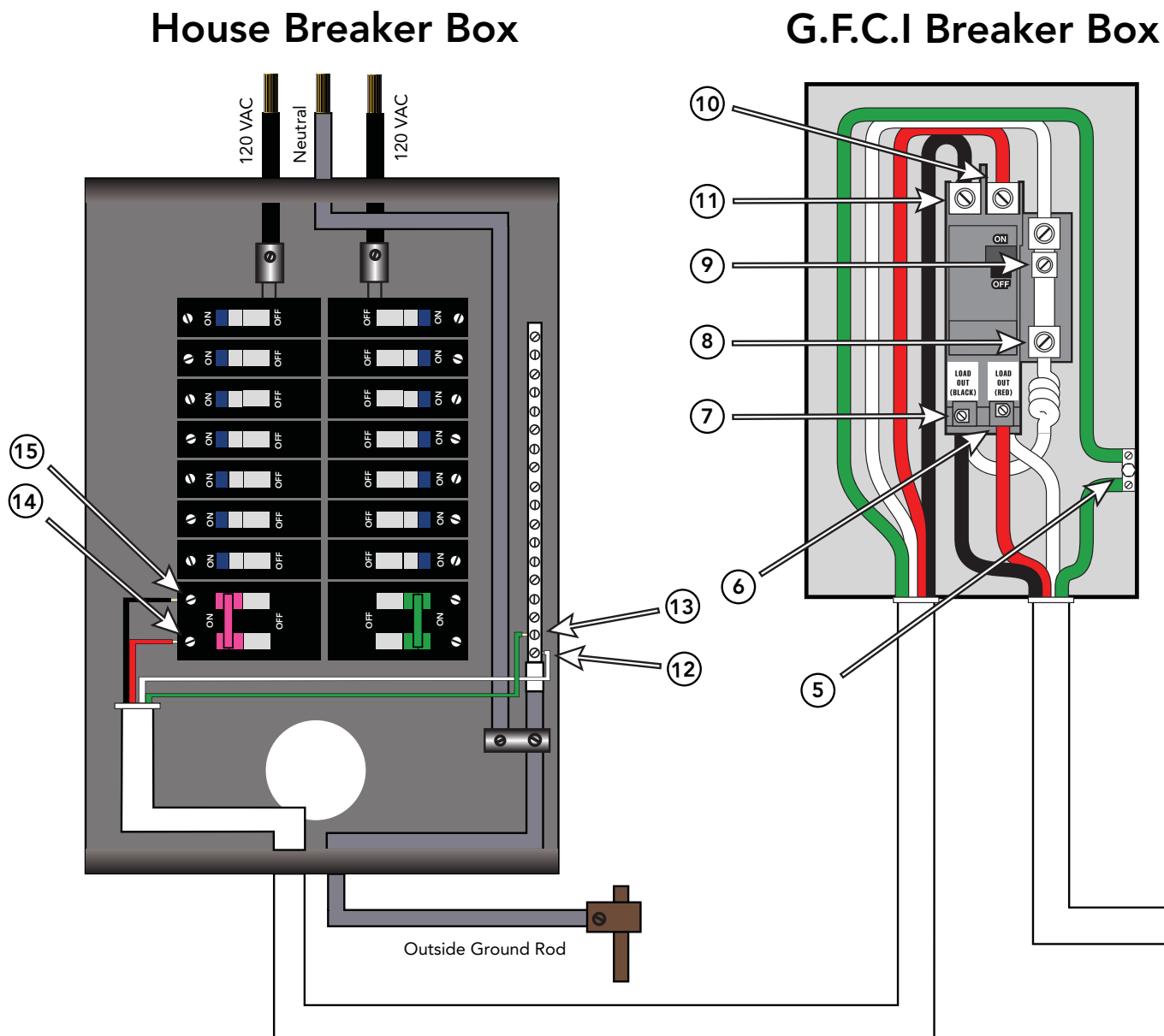

Correct Voltage	When Probes Are Placed Across
0v	[3 - 4] [5 - 8] [5 - 9] [12 - 13]
108V - 132V	[1 - 3] [5 - 6] [5 - 10] [12 - 14] [13 - 14] [2 - 3] [5 - 7] [5 - 11] [12 - 15] [13 - 15]
216V - 264V	[1 - 2] [6 - 7] [10 - 11] [14 - 15]

Spa System Box 240VAC Service

Bottom view of G.F.C.I

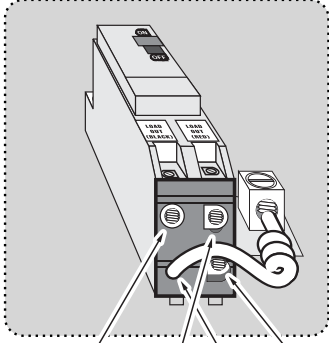

Black (Hot) ⑦
 White White
 Red (Hot) ⑥

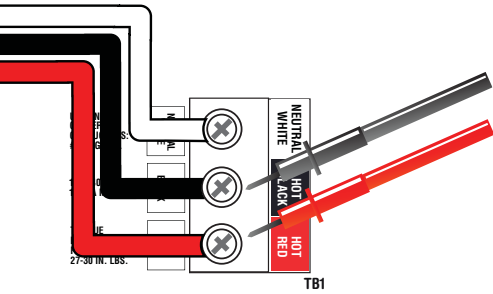
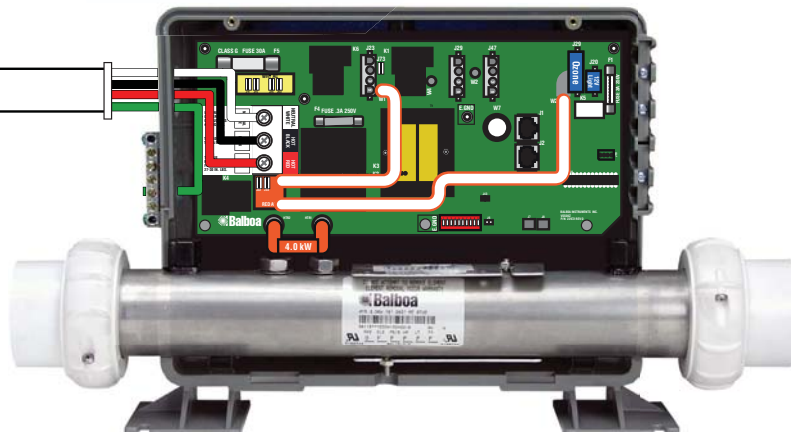
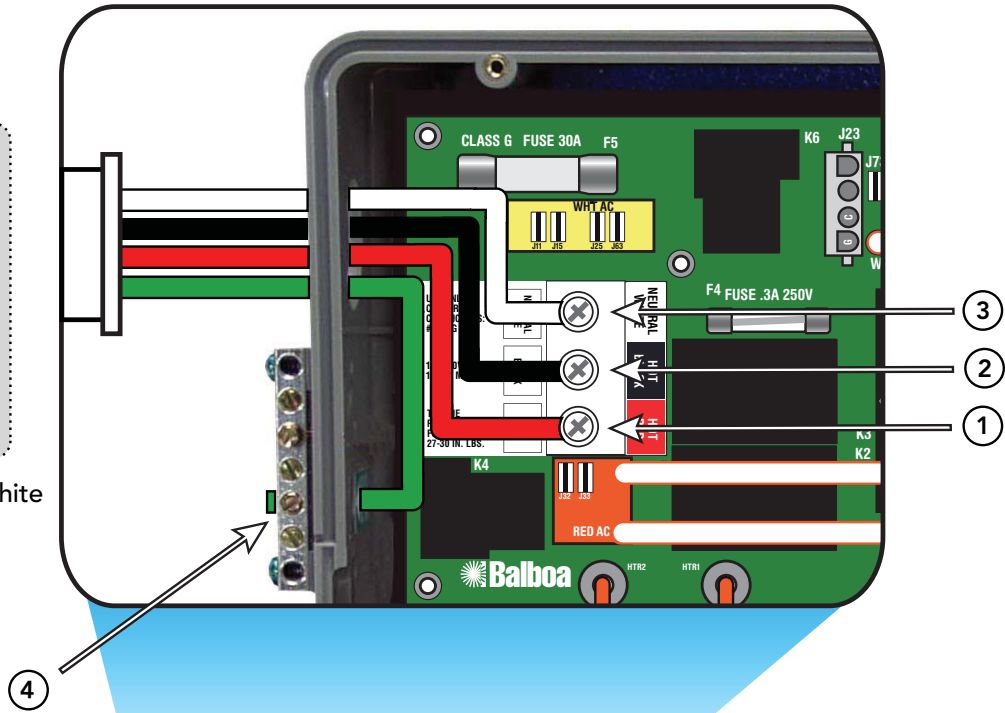

Test for Voltages by placing probes on these locations

Wiring Checks



WIRING CHECK PRECAUTIONS

- When working in a system box always be aware that it may contain high voltage.
- Always keep your fingers and hand tools away from any wiring or circuit board when the power is on. Touching anything in these areas can result in serious injury.
- All service calls, no matter how minor, should include a complete wiring check, beginning with the house breaker.



CHECK FOR LOOSE CONNECTIONS OR DAMAGED WIRES

- Make sure the power is off before you touch any wiring.
- Once the power is off, carefully examine all wires for cuts or defects.

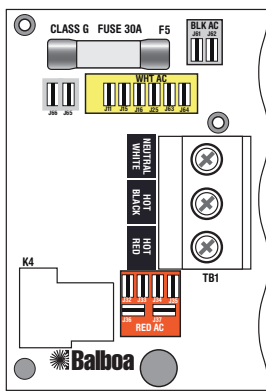

TB1



SYSTEM BOX WIRE GAUGE CHECK

When inspecting the wiring for any control system, note that connections for the incoming wires are clearly labeled at the main terminal block.

- 30A service – minimum ten gauge copper wire.
- 40A service – minimum eight gauge copper wire.
- 50A service – minimum six gauge copper wire.

These wires must connect the house breaker box, through the local disconnect, to the main terminal block. The wiring diagram inside the system box shows the main terminal block as TB1.

IMPORTANT

Using non-copper wire can be dangerous, and also can be the cause of a spa's malfunction. If non-copper wire is used at any point, we do not recommend servicing the spa until an electrician replaces it with the proper gauge copper wire.

IMPORTANT

This service must be single phase. Any abnormal voltage reading requires an electrician. Do not attempt to fix these types of problems yourself. **High voltage can seriously injure or kill.**

Total Ampere Rating of Power System	Minimum wire size Use Copper ONLY, with 90 ° C insulation	Ampere Rating of G.F.C.I. Circuit-breaker
0 A to 16 A	#12 AWG	20
16 A to 20 A	#10 AWG	25
20 A to 24 A	#10 AWG	30
24 A to 28 A	#8 AWG	35
28 A to 32 A	#8 AWG	40
32 A to 36 A	#6 AWG	45
36 A to 40 A	#6 AWG	50

Spa Behavior -- Start-up Information

See manufacturer's owners manual or reference card for general information on operating the spa, including programming filters and other settings that are changed from the topside control panel.

PRIMING MODE

In Priming Mode, the "Mode" button toggles the ozone on/off (with a 15-second time-out). This can be useful if you want to verify ozone generator operation without waiting for a filter cycle. This feature is not available on smaller panels where Mode is a multi-button sequence, since such a sequence exits Priming Mode.

GENERAL FILTER INFORMATION

- On any system with a Deluxe panel, the filter times and durations are completely programmable from the topside control panel, and the first filter may not run for many hours after power-up. If you want the filter to run sooner, you have to either reprogram the filter or advance the time to just before the filter start.
- On all other systems, the first filter starts 6 minutes after power-up and the duration can be chosen (either using button sequences on the topside control panel or via a DIP switch) between several preset choices. Note that if you let Priming Mode exit automatically after 4 minutes, you have 2 more minutes before the first filter runs after power-up. Exiting Priming Mode by pressing the "Temp," "Warm," or "Cool" buttons, allows up to 6 minutes available before the first filter runs.

IMPORTANT INFORMATION: If the filter settings have just been changed, it may take up to 24 hours for the filter cycle to reflect the changes. This is especially likely when changing from a very long filter duration (such as Continuous), to a short one, or vice versa.

- The low-speed pump (on non-circ) and ozone generator (if installed) will run during the filter cycles.
- The blower runs for 30 seconds at the start of each filter cycle. This will maintain water quality in the air channel.
- The pumps (other than pump 1 in non-circ, including pump 1 in circ) will run for 5 minutes at the start of each filter cycle.

HEATER START UP INFORMATION

On M-7 systems, the heater goes through a testing phase every time it starts up to assure that there is adequate water flow. This provides sophisticated dry fire and low flow protection. It can be confusing if you don't know what to expect. Step by step, here is what happens. (Note that the timing/temperature details may be slightly different on some older M7 systems.)

- Prior to heating, the pump is run for at least two minutes, and then the temperature difference between the sensors is assessed. It must be 2°F/1.0°C or less for heating to proceed, otherwise an error is issued.
- The heater turns on for 6.5 to 18 seconds (depending on heater voltage and wattage). At this point, the heat indicator on the panel is "solid." During this time the panel is not immediately responsive.
- The heater turns off for 90 seconds, making sure that the water flow keeps the temperature rise small and short. (Abnormal water flows, or lack of water, will produce a large and/or long temperature rise, and the system faults in that situation.) At this point, the heat indicator on the panel may appear to "shimmer" or "dim" (on some panels this may be less obvious from certain angles and more obvious from other angles, or in different lighting).
- If the dry fire test has passed, heating turns back on to heat the spa. The heat indicator on the panel returns to "solid".
- During spa heating, a difference between the sensors of 2°F/1.0°C, or perhaps 3°F/1.5°C (at least with 4-6kW 240V heaters), is considered normal. A significantly higher difference, however, is usually indicative of a flow problem, and will cause a fault which disables the heating for at least a minute (and then restarts the whole above process).

Diagnosing M7 Topside Control Panels

Panel messages are a quick clue toward solving a variety of problems. Here are the most common messages and what they mean.

PRELIMINARY PANEL CHECK

- If the problem is not obvious, look on the topside control panel for diagnostic messages. If no messages are seen, run through all spa functions and note any inconsistent operation.
- Most error messages are stored in the fault log. To view the fault log, the spa must be in test mode and the spa light must be turned on.

Once you have determined that proper voltage is running through the circuit board and transformer, continue to the topside control panel. A panel that is not functioning properly may include the following symptoms: low voltage such as missing or scrambled segments, missing icons on the LCD, non-functional LED's, or nonfunctional buttons. If any of these symptoms are present, perform the following:

- Turn the power off and unplug the panel from the circuit board.
- Then, plug in your test panel and restore power. If everything functions normally, replace the topside panel.
- Disconnect ozone generator (if applicable).
- If you still see symptoms of low voltage, such as a sluggish, blank or partially blank panel, or if the display or the LED's do not function at all, turn the power off; unplug the ozone generator (if equipped); then restore power to the system. If the problem persists, turn off the power and replace the circuit board.

PANEL DISPLAY MESSAGES

THE PANEL DISPLAYS:

HH, OHH, or HTR TEMP LMT

At least one of the sensors has detected water temperatures of 118°F inside the heater. Or,

THE PANEL DISPLAYS:

OH, OHS, or SPA TEMP LMT

One of the sensors has detected the temperature of the water coming into the heater to be 110°F, and so the water in the spa is likely to be that hot. These indicate that the spa has shut down due to an overheat situation.

NOTE: Overheating may occur if the low-speed pump is set to operate for extended periods of time, or if the incorrect pump is installed. In rare cases (usually warmer climates), the circulation pump may also cause overheating.

MOST PROBABLE OVERHEATING CAUSES, INSPECT THESE FIRST

- Check slice or ball valves. Make sure that they are open.
- Make sure the correct pump is installed.
- Clean the filter/skimmer if there is any blockage.
- Check heater element alignment.
- Check for debris on the heater element.
- In extremely hot weather, check for proper cabinet ventilation.
- Make sure the temperature sensor is fully inserted into the sensor fitting on the heater.
- Check for excessive filter duration.

NOTE: A common programming mistake is overlapping filter times that may cause the spa to filter continuously.

- Check the water level.
- Check the water temperature with an accurate temperature thermometer. Remove the spa cover and allow the water to cool to below 108° F. Adding cool water may be necessary. Touch any button to reset the system. If the water is still hotter than the set temperature, press the blower button (if applicable) to cool the spa.

If the Problem Recurs, test the Sensor Set.

THE PANEL DISPLAYS:

SA, S_nA, S_nH, or
SENSOR A
or SERVICE REQ

THE PANEL DISPLAYS:

S_b, S_nb, S_nt, or
SENSOR B
or SERVICE REQ

This indicates that the spa has shut down due to an open or faulty sensor. If the problem recurs, test the sensor set. (See Testing the Sensor Set.)

NOTE: In rare cases, rapid system overheat causes sensor error messages. Be sure to rule out possible situations like no flow or no water.

THE PANEL DISPLAYS:

S_n, S_nS, or SENSOR SYNC

This indicates that the sensors are out of balance.

If alternating with temperature, it may just be a temporary condition. If flashing by itself, spa is shut down. If the panel also displays "Service Req," spa is shut down. If the spa shuts down due to this error, one (or both) of the sensors are probably reading several degrees off. If the problem recurs, test the sensor set.

THE PANEL DISPLAYS:

cd, CLd, or COLD WATER

Indicates the sensor detects a possible freeze condition.

This Freeze Condition message does not appear on M-7 software showing a Software Version ID of 01 or greater. This is a normal spa function; no further action is necessary.

When either sensor reads below 40° F, the system provides freeze protection. It automatically activates the pump (and the heater if necessary) to circulate the water and warm the plumbing. The equipment stays on until the sensors detect that the spa temperature has risen to within 15°F of the set temperature. The other pumps and the blower will purge for 30 seconds to 2 minutes at the end of the freeze condition. If pump 1 was turned on due to this reason alone, this message will appear for up to two minutes right after very cold water is detected.

NOTE: Internal freeze protection only functions when there is proper power running to the spa, and the control system is operational. Using an optional freeze sensor may be necessary in extreme climates to prevent plumbing damage, but will only work properly if placed inside the spa skirt in the coldest area.

All spa models are different in shape and size and have different thermal characteristics; therefore, Balboa Water Group cannot be held responsible for freeze damage to the spa's plumbing. Testing is the responsibility of the spa manufacturer and must be done to determine the best location for the freeze sensor.

THE PANEL DISPLAYS:

IC, ICE, or FREEZE COND

This indicates that the auxiliary sensor detects a possible freeze condition. This is a normal spa function; no further action is necessary.

When the auxiliary sensor reads around 40°F (actual temperature dependent on specific auxiliary sensor used), the system provides freeze protection. It automatically activates all of the pumps and the blower to circulate water and warm the plumbing.

Diagnosing M7 Topside Control Panels (cont.)

NOTE: This auxiliary freeze protection functions at all times, even when another fault condition has occurred and has otherwise shut the spa down.

Any time the lower of the two temperature sensors goes below 45°F, all pumps/blowers turn on. They continue to run for 4 minutes after the temperature reaches 45°F or above. As soon as the temperature falls below 45°F again, this process restarts. This "simplified" sensor freeze protection functions at all times, even when another fault condition (other than total sensor failure) has occurred and has otherwise shut the spa down.

THE PANEL DISPLAYS:

HL, HFL, or HTR FLOW LOW

This indicates that a substantial difference in temperature between sensors has been detected during heating.

This could indicate a flow problem. Check water level in spa. Refill, if necessary. If the water level is okay, make sure the pumps have been primed. *On the fifth occurrence of the above message the panel will display:*

LF, or LOW FLOW

This indicates a persistent flow problem. The heater is shut down while all other spa functions continue to run normally. Power on the spa must be cycled before the heater will function again.

THE PANEL DISPLAYS:

**dr, dr4, or HEATER MAY
BE DRY--
WILL RETEST
SHORTLY**

This indicates that there is not enough water in the heater. Spa shuts down for 15 minutes.

This could indicate poor flow or air bubbles in the heater.

On the third consecutive occurrence of the above message (without a successful heating cycle in between) the panel will display:

**dy, dr4, or HEATER DRY
SERVICE REQ**

Spa is shut down and will not reset in 15 minutes. Press any button to reset manually.

THE PANEL DISPLAYS:

--F, --C, ---C or --

This indicates that the temperature is completely unknown because the pump has not yet run for 2 minutes after Priming Mode was exited. This is only displayed for 2 minutes at power-up.

SOME TROUBLESHOOTING SCENARIOS

You find out the system is in "OHH." This alone doesn't explain a lot. What led up to the "OHH" is much more important. If it's a Prestige, review the fault log carefully. Otherwise, see if the user has any additional information (for example, how long before the "OHH" was the spa panel last checked, and how hot was the water then). If the spa has cooled, see whether the problem can happen again, this time watching carefully to see if there are additional clues leading to the "OHH" (for example, other messages that appear shortly before the "OHH" happens).

You find out the system keeps showing "HFL," or is now in "LF," or is shut down due to a "dry" fault. Put the spa in test mode with the light on, so that you see the two sensor temperatures. Are they normal (within 1°F/0.5°C) when not heating? How far apart are they when heating? "HFL" happens when they are 6°F/3°C apart (4°F/2°C on 120V and other low-heater-wattage systems), see how quickly that happens after heating starts. If it's getting close to that right away, it's probably a consistent flow problem, but if it's nowhere close to the "HFL"-causing temperature difference, the flow problem may be intermittent or only occur in certain specific situations.

LOW VOLTAGE

At Balboa, it's been our experience that the majority of the problems associated with electronic control systems are due to low voltage.

BROWN OUTS

"Brown outs" can have an effect on the spa's operation in a variety of ways. The control panel may go blank, have scrambled messages on the LCD, or only a few features will function.

If the system is getting the proper voltage at TB1, but still doesn't operate, then test for a blown power input fuse.

CHECKING THE SYSTEM POWER INPUT FUSE



Warning

These procedures are performed while the system is powered up and running under peak loads. **Be careful.**

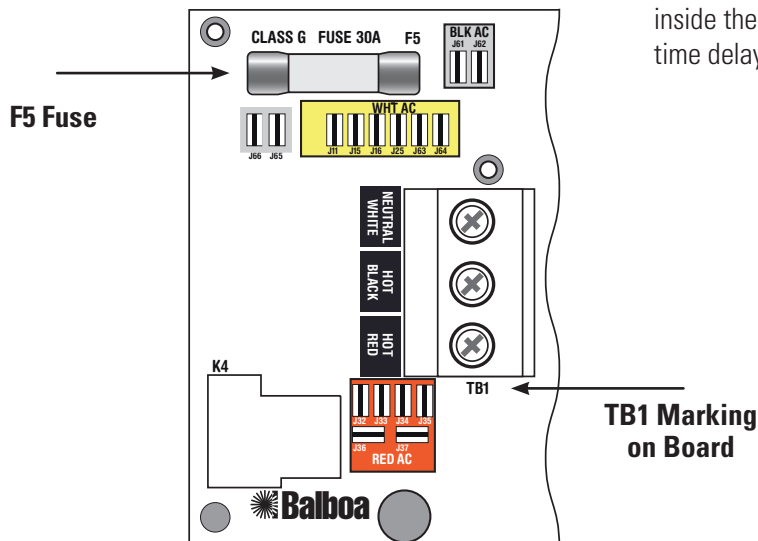

Terminal Block 1 & F5 Fuse on a VS500Z Board

If your system uses 120V peripheral devices (below):

- Measure between the white TB1 terminal and F5 power input fuse on the side farthest away from the circuit board edge (opposite the F5 silk screen). You should see 120 volts.
- If the system is equipped with the additional F6 power input fuse, measure F6 in the same manner. You should also see 120 volts.

If your system uses 240V peripheral devices (below):

- Measure between the red TB1 terminal and F5 power input fuse on the side farthest away from the circuit board edge (opposite the F5 silk screen). You should see 240 volts.
- If the system is equipped with the additional F6 power input fuse, measure F6 in the same manner. You should also see 240 volts.
- If you determine that there is no voltage at one or both locations, then the system power input fuse(s) need to be replaced. Only use a fuse of the same type and amp rating when you replace any of these fuses.

Elite System

- Measure fingers 5 and 6 of the circuit board. You should see either 120V or 240V, depending upon the system configuration.
- If you determine that there is no voltage at fingers 5 and 6, then the system power input fuse needs to be replaced. This fuse is located in the large fuse block inside the system box. This configuration utilizes a 30A time delay fuse.

Diagnosing M7 Topside Control Panels (cont.)

- **NOTE FOR ALL SYSTEMS** In each situation, the most likely reason for the system power input fuse to blow is a pump problem. However, on occasion, a blower problem may also cause this fuse to blow if a 10A blower fuse is not built in.

Once the power input fuse has been changed

- Probe the red wire and the white neutral wire. Again, voltage must be between 108 and 132 V.
- Check the voltage between the black and red wires again. Acceptable voltage range is between 216 and 264 V.

THESE READINGS SHOULD BE TAKEN UNDER PEAK LOAD CONDITIONS.



Important

If the voltage is not in the acceptable range, call an electrician or the local electric company to diagnose the problem.

TO DETERMINE THE CAUSE OF A BLOWN POWER INPUT FUSE

Perform the following **sequence of tests**.

Test the System

- Turn the power off.
- Be sure to replace the system power input fuse with the same type.
- Unplug the blower and all pumps.
- Restore the power and verify system operation.
- If the fuse blows, then re-check the internal system wires and connector for burns, cracks or cuts in insulation.
- If the fuse does not blow, turn the power off and plug in the pump.

NOTE: Be sure to test each device individually.

Test the Pump

- Restore the power and activate the pump.
- If the fuse blows, there is a pump problem.
- If the fuse does not blow, turn off the power.

Test the Blower

- Plug in the blower.
- Power up the system and activate the blower.
- If the fuse blows, then there is a blower problem.
- If the fuse does not blow, the combined pump and blower amperage may be excessive. To verify this, first check with your spa manufacturer for amperage draw limits on each device.
- Since the blower should now be running, you can check the amperage draw with an ammeter by measuring around the black blower wire and compare with manufacturer's specifications.

TEST THE AMPERAGE DRAW

- Turn off the power, disconnect the blower, make sure the pump is plugged in, and restore power.
- Start the pump and switch to high speed (if available), this should draw the most current.
- Make sure all jets and valves are open.
- Check the amperage at the red pump wire. Compare your reading with manufacturer specifications. (If the other plug-in devices exist, they should be tested in the same way.)
- If the amperage draw for each device is within manufacturer's specifications, the problem could be a nuisance spike in the pump, or water in the blower.



NOTE: These slow-blow fuses are not always discolored when blown. Always test continuity of a fuse with an ohmmeter.

NOTE: Miswiring of the spa is the most common reason for this fuse to blow. However, a lightning strike in the area is a possible, though less likely, cause of the failure.

ML Series Panels -- For Use with EL and GL Systems

ML900



ML700



ML554



ML553



ML551



ML550

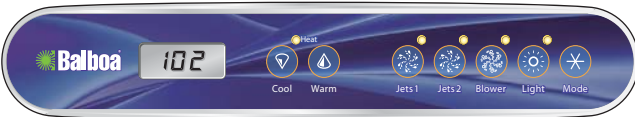

ML400



ML260



ML240



ML200



"Molex" Type,
ML/GL Connector



ML900 Panel Operation

Diagnostic Messages section for the ML900 is unique. Refer to the User Guide for additional information. User Guide for panel ML900 is 40568-99.

Initial Start-up

When your spa is first actuated, it will go into Priming mode (after displaying some configuration information). Please see "Spa Behavior -- Start-up Information" for additional information.

The Priming mode will last for up to 4 minutes and then the spa will begin to heat and maintain the water temperature in the Standard mode. You can exit Priming mode early by pressing "Warm" or "Cool."

Mode/Prog

This button is used to switch between standard, economy, and sleep modes. Press "Mode/Prog" to enter mode programming, press "Cool" to cycle through to desired mode (LCD flashes until confirmed), then press "Mode/Prog" to confirm selection

Standard mode maintains the desired temperature. Note that the last measured spa temperature displayed is current only when the pump has been running for at least 1 minute. The "**STANDARD**" icon will display until the mode is changed.

Economy mode heats the spa to set temperature only during filter cycles. The "**ECONOMY**" icon will display until mode is changed. Pressing "Jets 1" while in Economy mode puts the spa in Standard-In-Economy mode, which operates the same as Standard Mode, then reverts to Economy Mode automatically after 1 hour. Both the "**STANDARD**" and "**ECONOMY**" icons display in this mode. During this time, a press of the "Mode/Prog" button will revert to Economy Mode immediately.

Sleep mode heats the spa to within 20°F (11°C) of the set temperature only during filter cycles. The "**SLEEP**" icon will display until mode is changed.

Standby Mode

Pressing "Warm" or "Cool" then "Jets 2" will turn off all spa functions temporarily. This is helpful when changing a filter. Pressing any button resets the spa. On some systems the "Jets 1" button will control the pump in Standby Mode ("Drain Mode"). In this case, press any other button to exit.

Locking the Panel

Press "Time" "Jets 1" then "Warm" within 3 seconds. When locked, the PL "PL " light will light. All buttons are frozen except the "Time" button. To unlock the panel, press "Time" "Jets 1" then "Cool."

Locking the Set Temperature

Press "Warm" or "Cool" then "Time," "Jets 1," and "Warm" within 3 seconds to activate the lock. The TL "TL " light will light when the set temperature is locked.

To unlock the set temperature, press "Warm" or "Cool" then "Time," "Jets 1" and "Cool."

Time

When time hasn't been programmed, the "**TIME**" icon flashes. (Time settings on EL1000 and some EL2000 systems are not preserved in the event of power loss; time will have to be reprogrammed upon each power up.)



Setting the Time

Once the spa has been properly connected the first time (every power up on the EL1000 and some EL2000 systems), notice the "**TIME**" icon appearing on the screen.

Press  then 

Select the hour by pressing  Or  (Each press changes the time by 1 minute)

Press  to enter.

Select minutes by pressing  Or  (Each press changes the time by 1 minute)

Press  to exit the time setting procedure and enter the optional filter cycle programming. (Exits programming on some EL1000 and some EL2000 systems.)

Press  to exit programming.

ML700 Panel Operation

Diagnostic Messages section for the ML700 is unique. Refer to the User Guide for additional information. User Guide for panel ML700 is 40520-99.

Initial Start-up

When your spa is first actuated, it will go into Priming mode (after displaying some configuration information). Please see "Spa Behavior -- Start-up Information" for additional information.

The Priming mode will last for up to 4 minutes and then the spa will begin to heat and maintain the water temperature in the Standard mode. You can exit Priming mode early by pressing "Warm" or "Cool."

Mode/Prog

This button is used to switch between standard, economy, and sleep modes. Press "Mode/Prog" to enter mode programming, press "Cool" to cycle through to desired mode (LCD flashes until confirmed), then press "Mode/Prog" to confirm selection.

Standard mode maintains the desired temperature. Note that the last measured spa temperature displayed is current only when the pump has been running for at least 1 minute. The "**STANDARD**" icon will display until the mode is changed.

Economy mode heats the spa to set temperature only during filter cycles. The "**ECONOMY**" icon will display until mode is changed. Pressing "Jets 1" while in Economy mode puts the spa in Standard-In-Economy mode, which operates the same as Standard Mode, then reverts to Economy Mode automatically after 1 hour. Both the "**STANDARD**" and "**ECONOMY**" icons display in this mode. During this time, a press of the "Mode/Prog" button will revert to Economy Mode immediately.

Sleep mode heats the spa to within 20°F (11°C) of the set temperature only during filter cycles. The "**SLEEP**" icon will display until mode is changed.

Standby Mode

Pressing "Warm" or "Cool" then "Jets 2" will turn off all spa functions temporarily. This is helpful when changing a filter. Pressing any button resets the spa. On some systems the "Jets 1" button will control the pump in Standby Mode ("Drain Mode"). In this case, press any

other button to exit.

Locking the Panel

Press "Time" "Jets 1" then "Warm" within 3 seconds. When locked, the PL "PL  light will light. All buttons are frozen except the "Time" button. To unlock the panel, press "Time" "Jets 1" then "Cool."

Locking the Set Temperature

Press "Warm" or "Cool" then "Time," "Jets 1," and "Warm" within 3 seconds to activate the lock. The TL "TL  light will light when the set temperature is locked.

To unlock the set temperature, press "Warm" or "Cool" then "Time," "Jets 1" and "Cool."

Time

When time hasn't been programmed, the "**TIME**" icon flashes. (Time settings on EL1000 and some EL2000 systems are not preserved in the event of power loss; time will have to be reprogrammed upon each power up.)



Setting the Time

Once the spa has been properly connected the first time (every power up on the EL1000 and some EL2000 systems), notice the "**TIME**" icon appearing on the screen.

Press  then 

Select the hour by pressing  Or  (Each press changes the time by 1 minute)

Press  to enter.

Select minutes by pressing  Or  (Each press changes the time by 1 minute)

Press  to exit the time setting procedure and enter the optional filter cycle programming. (Exits programming on some EL1000 and some EL2000 systems.)

Press  to exit programming.

ML550, 551, 554 Panel Operation

Please refer to the following User Guides for more detailed information:

ML551/ML554 User Guide: P/N 40632-99

ML 550 User Guide: P/N 40569-99



ML551

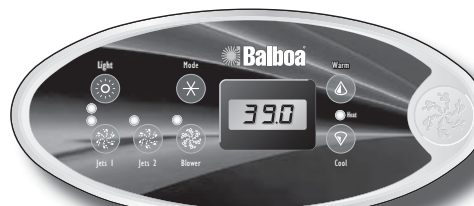

ML554



ML550

Cool/Warm ML500, 551, 554

Press the “Cool” or “Warm” button once to display the set temperature. Each time either button is pressed again, the set temperature will increase or decrease depending on which button is pressed. After three seconds, the LCD will automatically display the last measured spa temperature.

Mode ML500, 551, 554

This button is used to switch between Standard, Economy, and Sleep modes. Press “Mode” to enter mode programming, press “Cool” to cycle through to desired mode (LCD flashes until confirmed), then press “Mode” to confirm selection.

Sleep mode heats the spa to within 20°F (11°C) of the set temperature only during filter cycles. “SLP” will appear on the display until mode is changed.

Standby Mode

Pressing “Cool” or “Warm” followed by “Blower” or “Jets 2” or “Aux” will turn off all spa functions temporarily. This is helpful when changing a filter. Pressing any button exits Standby mode. On some systems the “Jets 1” button will control the pump in Standby Mode (“Drain Mode”). Then press any other button to exit. System reverts to previous mode after 1 hour.

Jets 1

Press the “Jets 1” button once to turn pump 1 on or off, and to shift between low and high speeds if equipped. If left running, the pump will turn off after a time-out period. The pump 1 low speed time-out on some systems may be as long as 4 hours.

On non-circ systems, the low speed of pump 1 runs when the blower or any other pump is on. It may also activate for at least 1 minute every 30 minutes to detect the spa temperature (polling) and then to heat to the set temperature if needed, depending upon mode. When the low speed turns on automatically, it cannot be deactivated from the panel; however, the high speed may be started.

Jets 2 (optional on some systems)

Press the “Jets 2” button once to turn pump 2 on or off, and to shift between low and high speeds if it is a two-speed pump. If left running, the pump will turn off after a time-out period.

Blower

1-speed operation: on/off,
2-speed operation: med/hi/off, or
3-speed operation: lo/med/hi/off.

If left on, the blower will automatically turn off after a time-out period.

NOTE: If your system does not have a “Blower” button, and is labeled as “Jets 3” instead, please refer to the respective User Guide listed above.

Light

Some systems are equipped with both a spa light and a fiber optic light; however, only one can be accessed by this panel. (Larger panels may be purchased so that both the spa light and fiber optic light can be utilized.) Depending upon how your spa is equipped and configured, the “Light” button will operate in one of three ways:

- 1) Press the “Light” button to turn the spa light on and off, and to shift between dim and bright settings if your light is dimmable.
- 2) If a fiber-optic light with wheel is installed, press the “Light” button once to start the light and wheel; press it again to stop the wheel, and then again to turn the light off.
- 3) If a fiber-optic light without a separate wheel stop is installed, press the “Light” button to turn it on and off.

Both a spa light and a fiber optic light may be used simultaneously on the EL8000 and EL5000 systems with a different panel.

If any light is left on, it will automatically turn off after a factory programmed time period.

Preset Filter Cycles

On all systems, the pump and the ozone generator will run during filtration. At the start of each filter cycle, the blower will run briefly on its highest speed to purge the air channels. The lowest speed of any other pumps and the mister will also run briefly. On some circ systems, pump 1 may also run for the duration of the filter.

(Note: This panel cannot be used to program filter cycles for systems that are programmed by time rather than by duration. For these systems, a larger panel is needed and the following description does not apply.)

The first filter cycle (“day”) begins 6 minutes after the spa is powered up. The second filter cycle (“night”) begins 12 hours later. Filter duration is programmable for 1-12 hours (“F 1”-“F 12”). The default filter duration can vary from system to system. To program, press “Cool” or “Warm,” then “Jets 1.” Press “Cool” or “Warm” to select the filter duration. Press “Jets 1” to select the number of filter cycles. The display will show “dn” (both “day” and “night” cycles); “d” (day cycle only); or “n” (“night” cycle only). Press “Cool” or “Warm” to adjust, then press “Jets 1” to exit the programming mode. For continuous filtration, use “F 12” and “dn”.

Freeze Protection

If the temperature sensors within the heater detect a low enough temperature, then the pump(s) and the blower automatically activate to provide freeze protection. The pump(s) and blower will run either continuously or periodically depending on conditions.

In colder climates, an optional additional freeze sensor may be added to protect against freeze conditions that may not be sensed by the standard sensors. Auxiliary freeze sensor protection acts similarly except with the temperature thresholds determined by the switch. See your dealer for details.

Locking Features

If this panel is used as the main panel, locking features will not be available.

If this panel is used as a remote or additional panel, it will lock when the main panel is locked. To unlock this panel, unlock the main panel.

In the same way, the set temperature can be locked and unlocked by a main panel. When the set temperature is locked, it cannot be changed from either panel.

Clean-up Cycle (optional)

When a pump or blower is turned on by a button press, a clean-up cycle begins 30 minutes after the pump or blower is turned off or times out. The pump and the ozone generator will run for one to four hours, depending on the system (on some systems, you can change this setting.)

ML550, 551, 554 Panel Operation (cont.)

Circ Pump (optional)

If your system is equipped with a circ pump, it may be configured to work in one of three different ways:

- 1) The circ pump operates continuously (24 hours) with the exception of turning off for 30 minutes at a time when the water temperature reaches 3°F (1.5°C) above the set temperature (most likely to happen in very hot climates).
- 2) The circ pump stays on continuously, regardless of water temperature.
- 3) The circ pump will come on when the system is checking temperature (polling), during filter cycles, during freeze conditions, or when another pump is on.

Ozone (optional)

On most systems, the ozone generator (if installed) runs during filter cycles (except when pump 1 is operating at high speed on a non-circ system) and during clean-up cycles. On some systems, the ozone generator operates whenever the pump runs.

If your system is configured with the optional ozone suppress feature, the ozone generator will turn off for 1 hour any time a function button (Jets 1, Jets 2, Blower, etc.) is pressed.

Displaying Info About Your Spa

There are several pieces of information about your spa that can be called up from the panel, but are only needed in special cases.

To access this information, press "Cool" or "Warm" then "Jets 1", then "Light". (Each press must be within 3 seconds of the previous press.) Then press "Cool" until you see "5 id" on the display. Press "Jets 1" to see the SSID (a series of 3 numbers, such as 100 133 10, which indicates the precise revision of the software in your spa), followed by the Mach software version number (such as 2.1), followed by "LSn" and then your spa's network ID number (consisting of both letters and digits displayed in 5 steps).

If you need to see this series of numbers again, and "5 id" is once again on the display, just press "Jets 1" again.

When done, press the "Light" button (more than once if necessary) until you see the normal temperature display.

User Preferences

There are several aspects of spa operation that you can customize using the User Preferences submenu.

Press "Cool" or "Warm" then "Jets 1", then "Light". (Each press must be within 3 seconds of the previous press.) At this point, if "LSn" is not showing on the display, press "Cool" until you see "LSn" on the display. Then press "Jets 1" to enter the User Preferences submenu.

Once in the User Preferences submenu, press "Cool" or "Warm" to cycle between these settings:

Sn – Suppress Reminders

When set to "Sn.Y", reminders are never displayed on the panel. When set to "Sn.n", reminders are displayed on the panel periodically.

Ln – Temperature in Celsius

When set to "Ln.Y", temperatures are displayed on the panel in degrees Celsius. When set to "Ln.n", temperatures are displayed in Fahrenheit.

24 – 24-hour Time Display

When set to "24.Y", time is displayed in 24-hour (military) format (00:00 is midnight, 23:00 is one hour before midnight). When set to "24.n", time is displayed in 12-hour (am/pm) format (12:00 is midnight, 11:00 pm is one hour before midnight).

cn – Clean-up Cycle Duration (some systems only)

When set to "cn.0", Clean-up Cycles are disabled. When set to "cn.1" through "cn.4", the number indicates how many hours each Clean-up Cycle will run.

Ad – Dolphin II Address

When set to "Ad.0", no addressing is used. Use this setting for a Dolphin I, or for a Dolphin II which is set for no address (which is the Dolphin II factory default). When set to "Ad.1" through "Ad.7", the number is the address (see your Dolphin II manual for details).

Editing User Preferences

View the setting.

The left two characters (before the decimal point) tell you what setting you're viewing or editing, the right most character (after the decimal point) tells you the value of that setting (for example, ".**Y**" for Yes or ".**N**" for No).

If the value is flashing, you're editing it. If the value is not flashing, you're just viewing it.

Press "Jets 1" to switch editing of the value on (flashing) or off (not flashing). Once you're editing the value (it's flashing), use the "Cool" or "Warm" buttons to change the value to the one you want.

After you change the value, you must press "Jets 1" again to stop the flashing before the change will register, and before you can view or edit another setting.

If you don't interact with the menu for more than 30 seconds, it may time out.

If you press "Light" to back out of the menu, or pause long enough for it to time out, while a value was flashing, the changes you were making to that setting are not remembered. But changes you previously made to other settings will be in effect.

Any User Preferences that you change will stay in effect "forever" or until you change them again (unless the spa's "persistent memory" is reset by a service technician), and will override the factory defaults for those settings.

**Note: The G.F.C.I. section does not apply on EL systems used outside the United States.
This G.F.C.I. section does not apply to GL Systems.**

WARNING: THE OWNER SHOULD TEST AND RESET THE G.F.C.I. ON A REGULAR BASIS TO VERIFY ITS FUNCTION.

G.F.C.I. PROTECTION

Your spa may be equipped with a G.F.C.I. Protection feature. If your spa does have this feature enabled, the G.F.C.I. Trip Test must occur to allow proper spa function.

Within 1 to 7 days after startup, the spa will trip the G.F.C.I. to test it. (The number of days is factory programmed.) The G.F.C.I. must be reset once it has been tripped. After passing the G.F.C.I. Trip Test, subsequent G.F.C.I. trips will indicate a ground fault or other unsafe condition requiring the power to the spa to be shut off.

G.F.C.I. TRIP TEST PROCEDURE

The installer can cause the G.F.C.I. Trip Test to occur sooner by initiating it with the following button sequence. Press "Warm", then "Jets 1", then "Light." (Each press must be within 3 seconds of the previous press.) Press the "Warm" button repeatedly until "**GF**" is displayed. Press "Jets 1" to select it. Press the "Warm" button until "**GF.N**" is displayed. Press "Jets 1" to initiate the G.F.C.I. Trip Test.

The G.F.C.I. should trip within several seconds and the spa should shut down. If it does not, shut down the power and manually verify that a G.F.C.I. breaker is installed and that the circuit and spa are wired correctly. Verify the function of the G.F.C.I. with its own test button. Restore power to the spa and repeat the G.F.C.I. Trip Test.

Once the G.F.C.I. is tripped by the test, reset the G.F.C.I. and the spa will operate normally from that point. You can verify a successful test by navigating to the "**GF**" item as described above, pressing "Jets 1" and then pressing the "Warm" button until you see "**GF.P**". The code signifies G.F.C.I. Status - Passed. The system will exit this menu in 30 seconds if no buttons are pressed.

ML200, 240, 260, 400 Panel Operation

Please refer to the following User Guides for more detailed information:

ML400 User Guide: P/N 40570-99 ML260 User Guide: P/N 40633-99

ML240 User Guide: P/N 40634-99 ML200 User Guide: P/N 40571-99



ML400



ML260, ML240, ML200

The pump responsible for heating and filtration (pump 1 low on non-circ systems, or the circ pump on circ systems) will be referred to simply as the pump.

Timeouts refer to a preset length of time that a function is programmed to operate before shutting off automatically. Certain conditions (filters or freeze) can cause a function to operate longer, while faults can cause a function to operate for a shorter length of time. The system keeps track of timeouts regardless of other conditions occurring. In multi-button sequences, if buttons are pressed too quickly in sequence, they may not register

Initial Start-up

When your spa is first actuated, it will go into Priming mode (after displaying some configuration information).

The Priming mode will last for up to 4 minutes and then the spa will begin to heat and maintain the water temperature in the Standard mode. You can exit Priming mode early by pressing "Temp".

Temp Set (80°F - 104°F/26.0°C - 40.0°C)

The last measured temperature is constantly displayed on the LCD. Your spa's set temperature range may vary from range shown above depending on your manufacturer's settings.

Note that the last measured spa temperature displayed is current only when the pump has been running for at least 1 minute.

Temp ML400

Press the "Temp" button once to display the set temperature. To change the set temperature, press the pad a second time before the LCD stops flashing. Each press of the "Temp" button will continue to either raise or lower the set temperature.

If the opposite direction is desired, release the pad and let the display revert to the current water temperature. Press the pad to display the set temperature, and again to make the temperature change in the desired direction. After three seconds, the LCD will automatically display the last measured spa temperature.

Mode ML400

A button combination is used to switch between standard, economy, and sleep modes. Press "Temp" followed by "Light" to enter mode programming, press "Temp" to cycle through to desired mode (LCD flashes until confirmed), then press "Light" to confirm selection.

Standard mode maintains the desired temperature. Note that the last measured spa temperature displayed is current only when the pump has been running for at least 1 minute. "SEd" will appear on the display momentarily when you switch into Standard Mode.

Economy mode heats the spa to the set temperature only during filter cycles. "Ecn" will appear solid when the temperature is not current and will alternate with the temperature when the temperature is current. Pressing "Jets" while in Economy mode puts the spa in **Standard-In-Economy mode**, ("SE") which operates the same as Standard Mode, then reverts to Economy Mode automatically after 1 hour. During this time, pressing "Temp" followed by "Light" will revert the mode to Economy immediately.

Sleep mode heats the spa to within 20°F (11°C) of the set temperature only during filter cycles. "SLP" will appear on the display until mode is changed.

Standby Mode ML400

Pressing "Temp" followed by "Aux" or "Jets 2" or "Blower" will turn off all spa functions temporarily. This is helpful when changing a filter. Pressing any button exits Standby mode. On some systems the "Jets" button will control the pump in Standby Mode ("Drain Mode"). In this case, press any other button to exit. System will revert to previous mode after 1 hour.



Jets ML400

Press the "Jets" button once to turn pump 1 on or off, and to shift between low and high speeds if equipped. If left running, the pump will turn off after a time-out period. The pump 1 low speed time-out on some systems may be as long as 4 hours.

On non-circ systems, the low speed of pump 1 runs when the blower or any other pump is on. It may also activate for at least 1 minute every 30 minutes to detect the spa temperature (polling) and then to heat to the set temperature if needed, depending upon mode. When the low speed turns on automatically, it cannot be deactivated from the panel; however, the high speed may be started.

Jets 2 (optional on some systems) ML400

If your system has a second pump but your panel does not have a "Jets 2" button, use the "Aux" button to control pump 2. Press the "Jets 2" button once to turn pump 2 on or off, and to shift between low and high speeds if it is a two-speed pump. If left running, the pump will turn off after a time-out period.

Blower (optional on some systems) ML400

If your system has a blower (and only one pump), but your panel does not have a "Blower" button, use the "Aux" button to control the blower.

1-speed operation: on/off;

2-speed operation: med/hi/off; or

3-speed operation: lo/med/hi/off.

If left on, the blower will automatically turn off after a time-out period.

Circ Pump (optional) ML400

If your system is equipped with a circ pump, it may be configured to work in one of three different ways:

- 1) The circ pump operates continuously (24 hours) with the exception of turning off for 30 minutes at a time when the water temperature reaches 3°F (1.5°C) above the set temperature (most likely to happen in very hot climates).
- 2) The circ pump stays on continuously, regardless of water temperature.
- 3) The circ pump will come on when the system is checking temperature (polling), during filter cycles, during freeze conditions, or when another pump is on.



Light ML400

Some systems are equipped with both a spa light and a fiber optic light; however, only one can be accessed by this panel. (Larger panels may be purchased so that both the spa light and fiber optic light can be utilized.) Depending upon how your spa is equipped and configured, the "Light" button will operate in one of three ways:

- 1) Press the "Light" button to turn the spa light on and off, and to shift between dim and bright settings if your light is dimmable.
 - 2) If a fiber-optic light with wheel is installed, press the "Light" button once to start the light and wheel, press it again to stop the wheel, and then again to turn the light off.
 - 3) If a fiber-optic light without a separate wheel stop is installed, press the "Light" button to turn it on and off.
- Again, both a spa light and a fiber optic light may be used simultaneously on the EL8000 and EL5000 systems with a different panel.

If any light is left on, it will automatically turn off after a factory programmed time period.

Ozone (optional) ML400

On most systems, the ozone generator (if installed) runs during filter cycles (except when pump 1 is operating at high speed on a non-circ system) and during clean-up cycles. On some systems, the ozone generator operates whenever the pump runs.

If your system is configured with the optional ozone suppress feature, the ozone generator will turn off for 1 hour any time a function button (Jets, Jets 2, Blower, etc.) is pressed.

ML200, 240, 260, 400 Panel Operation (cont.)

Clean-up Cycle (optional ML400)

When a pump or blower is turned on by a button press, a clean-up cycle begins 30 minutes after the pump or blower is turned off or times out. The pump and the ozone generator will run for one to four hours, depending on the system. (On some systems, you can change this setting; see User Preferences section.)

Freeze Protection ML400

If the temperature sensors within the heater detect a low enough temperature, then the pump(s) and the blower automatically activate to provide freeze protection. The pump(s) and blower will run either continuously or periodically depending on conditions. In colder climates, an optional additional freeze sensor may be added to protect against freeze conditions that may not be sensed by the standard sensors. Auxiliary freeze sensor protection acts similarly except with the temperature thresholds determined by the switch. See your dealer for details.

Locking Features ML400

If this panel is used as the main panel, locking features will not be available. If this panel is used as a remote or additional panel, it will lock when the main panel is locked. To unlock this panel, unlock the main panel. In the same way, the set temperature can be locked and unlocked by a main panel. When the set temperature is locked, it cannot be changed from either panel.

Preset Filter Cycles ML400

On all systems, the pump and the ozone generator will run during filtration. At the start of each filter cycle, the blower will run briefly on its highest speed to purge the air channels. The lowest speed of any other pumps and the mister will also run briefly. On some circ systems, pump 1 may also run for the duration of the filter.

(Note: This panel cannot be used to program filter cycles for systems that are programmed by time rather than by duration. For these systems, a larger panel is needed and the following description does not apply.)

The first filter cycle ("day") begins 6 minutes after the spa is powered up. The second filter cycle ("night") begins 12 hours later. Filter duration is programmable for 1-12 hours ("F 1"-

"F 12"). The default filter duration can vary from system to system. To program, press "Temp" then "Jets." Press "Temp" to select the filter duration. Press "Jets" to select the number of filter cycles. The display will show "d n" (both "day" and "night" cycles); "d" (day cycle only); or "n" ("night" cycle only). Press "Temp" to adjust, then press "Jets" to exit the programming mode. For continuous filtration, use "F 12" and "d n".

Displaying Information About Your Spa ML400

There are several pieces of information about your spa that can be called up from the panel, but are only needed in special cases.

To access this information, press "Temp" then "Jets", then "Light". (Each press must be within 3 seconds of the previous press.) Then press "Temp" until you see "5 id" on the display. Press "Jets" to see the SSID (a series of 3 numbers, such as 100 133 10, which indicates the precise revision of the software in your spa), followed by the Mach software version number (such as 2.1), followed by "LS n" and then your spa's network ID number (consisting of both letters and digits displayed in 5 steps).

If you need to see this series of numbers again, and "5 id" is once again on the display, just press "Jets" again. When done, press the "Light" button (more than once if necessary) until you see the normal temperature display.

User Preferences ML400

There are several aspects of spa operation that you can customize using the User Preferences submenu. Press "Temp" then "Jets", then "Light". (Each press must be within 3 seconds of the previous press.) At this point, if "LS r" is not showing on the display, press "Temp" until you see "LS r" on the display. Then press "Jets" to enter the User Preferences submenu.

Once in the User Preferences submenu, press "Temp" to cycle between these settings:

5r – Suppress Reminders

When set to "5r.3", reminders are never displayed on the panel. When set to "5r.n", reminders are displayed on the panel periodically.

᠆᠘ – Temperature in Celsius

When set to “᠆᠘.᠑”, temperatures are displayed on the panel in degrees Celsius. When set to “᠆᠘.᠒”, temperatures are displayed in Fahrenheit.

᠒4 – 24-hour Time Display

When set to “᠒4.᠑”, time is displayed in 24-hour (military) format (00:00 is midnight, 23:00 is one hour before midnight). When set to “᠒4.᠒”, time is displayed in 12-hour (am/pm) format (12:00 is midnight, 11:00 pm is one hour before midnight).

᠘᠘ – Clean-up Cycle Duration (some systems only)

When set to “᠘᠘.᠐”, Clean-up Cycles are disabled. When set to “᠘᠘.1” through “᠘᠘.4”, the number indicates how many hours each Clean-up Cycle will run.

᠕᠔ – Dolphin II Address

When set to “᠕᠔.᠐”, no addressing is used. Use this setting for a Dolphin I, or for a Dolphin II which is set for no address (which is the Dolphin II factory default). When set to “᠕᠔.1” through “᠕᠔.7”, the number is the address (see your Dolphin II manual for details).

Editing User Preferences ML400

View the setting.

The left two characters (before the decimal point) tell you what setting you’re viewing or editing, the right most character (after the decimal point) tells you the value of that setting (for example, “.᠑” for Yes or “.᠒” for No). If the value is flashing, you’re editing it. If the value is not flashing, you’re just viewing it.

Press “Jets” to switch editing of the value on (flashing) or off (not flashing).

Once you’re editing the value (it’s flashing), use the “Temp” buttons to change the value to the one you want.

After you change the value, you must press “Jets” again to stop the flashing before the change will register, and before you can view or edit another setting.

If you don’t interact with the menu for more than 30 seconds, it may time out.

If you press “Light” to back out of the menu, or pause long

enough for it to time out, while a value was flashing, the changes you were making to that setting are not remembered. But changes you previously made to other settings will be in effect.

Any User Preferences that you change will stay in effect “forever” or until you change them again (unless the spa’s “persistent memory” is reset by a service technician), and will override the factory defaults for those settings.

G.F.C.I. Protection ML400

Your spa may be equipped with a G.F.C.I. Protection feature. If your spa does have this feature enabled, the G.F.C.I. Trip Test must occur to allow proper spa function.

Within 1 to 7 days after startup, the spa will trip the G.F.C.I. to test it. (The number of days is factory programmed.) The G.F.C.I. must be reset once it has been tripped. After passing the G.F.C.I. Trip Test, subsequent G.F.C.I. trips will indicate a ground fault or other unsafe condition requiring the power to the spa to be shut off.

G.F.C.I. Trip Test Procedure: ML400

The installer can cause the G.F.C.I. Trip Test to occur sooner by initiating it with the following button sequence.

Press “Temp,” then “Jets,” then “Light.” (Each press must be within 3 seconds of the previous press.) Press the “Temp” button repeatedly until “᠑᠑᠘” is displayed. Press “Jets” to select it. Press the “Temp” button until “᠑᠆.᠒” is displayed. Press “Jets” to initiate the G.F.C.I. Trip Test.

The G.F.C.I. should trip within several seconds and the spa should shut down. If it does not, shut down the power and manually verify that a G.F.C.I. breaker is installed and that the circuit and spa are wired correctly. Verify the function of the G.F.C.I. with its own test button. Restore power to the spa and repeat the G.F.C.I. Trip Test.

Once the G.F.C.I. is tripped by the test, reset the G.F.C.I. and the spa will operate normally from that point. You can verify a successful test by navigating to the “᠑᠑᠘” item as described above, pressing “Jets” and then pressing the “Temp” button until you see “᠑᠑᠑”. The code signifies G.F.C.I. Status - Passed.

The system will exit this menu in 30 seconds if no buttons are pressed.

VL Series Panels -- For use with VS and GS Systems

VL802D



VL801D



VL702S



VL701S



VL700S



VL600S



DELUXE SYSTEMS



"Phone Plug" RJ Type, VL/VS Connector

STANDARD SYSTEMS

VL406U



VL406T



VL404



VL403

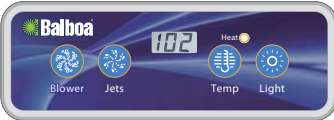

VL402



VL401



VL400



VL260



VL240



VL200



Note:
VL404 and VL403 have red
LED's on black background



“Phone Plug” RJ Type,
VL/VS Connector

DUPLEX SYSTEMS

VS/GS Panel -- 300 & 500 Series and Operation

Please refer to the User Guides for additional information.

500 Z Series User Guide: P/N 40789

300/300F Series User Guide: P/N 40839 (for systems with software V38 only)

500 SZ Series User Guide: P/N 40790

300/300F Series User Guide: P/N 40887 (for systems with software v41 only)

500 DZ Series User Guide: P/N 40788

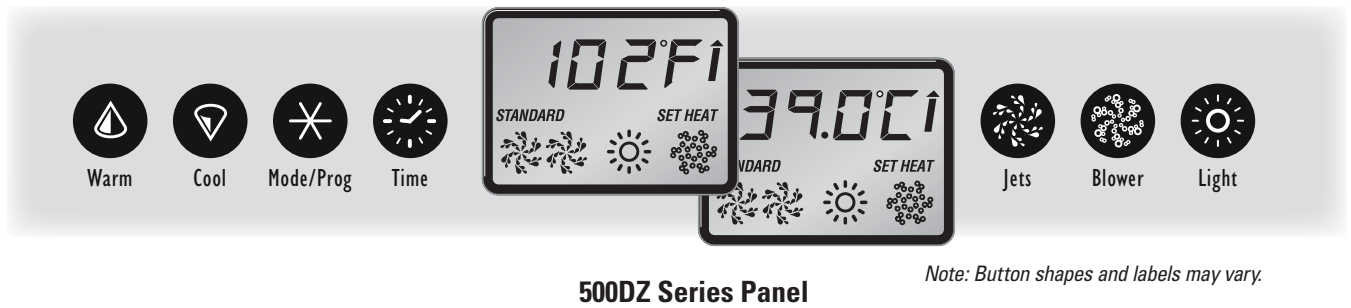

Initial Start-up

Your spa will enter Priming Mode (P-) when it is energized. During Priming Mode, press “Jets” button(s) repeatedly and be sure all pumps are free of air. Priming Mode lasts less than 5 minutes. Press “Temp” to exit. After Priming Mode, the spa will run in Standard Mode (see Mode section). Some panels may not have a “Temp” button. On these panels the “Set,” “Warm,” or “Cool” buttons are used.

The pump responsible for heating and filtration (pump 1 low-speed on non-circ system, or the circ pump on circ systems) will be referred to simply as the pump. In multi-button sequences, if the buttons are pressed too quickly in sequence, they may not register.

TEMP CONTROL (80°F - 104°F/26°C - 40°C)

The last measured water temperature is constantly displayed.

The water temperature displayed is current only when the pump has been running for at least 2 minutes.

On panels with a single “Temp” or “Set” button, to display the set temperature, press the button once. To change the set temperature, press the button a second time before the display stops flashing.

Each press of the button will continue to either raise or lower the set temperature. If the opposite direction is desired, allow the display to revert to the current water temperature. Press the button to display the set temperature, and again to make the temperature change in the desired direction.

On panels with “Warm” and “Cool” buttons, to display the set temperature, press “Warm” or “Cool” once. To change the set temperature, press a temperature button again before the display stops flashing. Each press of “Warm” or “Cool” will adjust the set temperature.

After three seconds, the display will stop flashing and begin to display the current spa temperature.

JETS

Jets 1 500Z, 500DZ, 500SZ Series

Press “Jets 1” to turn pump 1 on or off, and to shift between low and high speeds (if equipped). The low-speed will turn off after 4 hours. High-speed will turn off after 15 minutes. Low-speed may run automatically at times, during which it cannot be deactivated from the panel, but high-speed may be operated.

Jets 2/Jets 3/Blower (If equipped)

Press the corresponding button once to turn the device on or off. The device will turn off after 15 minutes. Pump 2 may be two-speed on some systems.

Some systems use this one button to control two devices. The first button press will activate one device. Press again to have both devices active. Press again to turn off the first device only. Press one more time to turn both devices off.

Jets 300F (Software v. 41)

Press “Jets” to turn the pump on or off, and to shift between low and high speeds (if equipped). If left running, the pump will turn off after a preset length of time, which on some systems may be as long as 2 hours for low speed. Low speed may run automatically at times, during which it cannot be deactivated from the panel, but high speed may be operated. The ozone generator (if installed) will activate anytime low speed is running.

Jets 300, 300F (Software v. 38)

Press “Jets” to turn the pump on or off, and to shift between low and high speeds (if equipped). The low speed will turn off after 4 hours. High speed will turn off after 15 minutes. Low speed may run automatically at times, during which it cannot be deactivated from the panel, but high speed may be operated. The ozone generator (if installed) will activate anytime low speed is running.

LIGHT

Press “Light” to operate the spa light. Turns off after 4 hours.

SETTING THE TIME OF DAY

When the spa is first powered up, the words SET TIME will flash on the display. Press “Time,” then “Mode/Prog,” then “Warm” or “Cool.” The time will begin changing in one-minute increments. Press “Warm” or “Cool” to stop the time from changing. Press “Time” to confirm.

MODE/PROG

Mode 500Z

- Depending on system configuration, mode changing may not be available and will be locked in Standard Mode.
- Mode is changed by pressing “**Temp**,” then “**Light**”.
- STANDARD Mode maintains set temperature. *5E* will be displayed momentarily when you switch into Standard Mode.
- ECONOMY Mode heats the spa to the set temperature only during filter cycles. *E2* will display when water temp is not current, and will alternate with water temp when the pump is running.
- SLEEP Mode heats the spa to within 20°F/10°C of the set temperature only during filter cycles. *5L* will display when water temp is not current, and will alternate with water temp when the pump is running.

Mode 500SZ

- Mode is changed by pressing “**Warm**” or “**Cool**,” then pressing “Mode.”
- STANDARD Mode maintains set temperature. *5E* will be displayed momentarily when you switch into Standard Mode.
- ECONOMY Mode heats the spa to the set temperature only during filter cycles. *E2* will display when water temp is not current, and will alternate with water temp when the pump is running.
- SLEEP Mode heats the spa to within 20°F/10°C of the set temperature only during filter cycles. *5L* will display when water temp is not current, and will alternate with water temp when the pump is running.

VS/GS Panel -- 300 & 500 Series and Operation (cont.)

Mode/Prog 500DZ

- Mode is changed by pressing “Warm” or “Cool,” then pressing “Mode/Prog” button.
- Standard Mode maintains set temperature and the STANDARD icon will be displayed.
- ECONOMY Mode heats the spa to the set temperature only during filter cycles. *Ecn* will display when water temp is not current, and will alternate with water temp when the pump is running. The ECONOMY icon will be displayed.
- SLEEP Mode heats the spa to within 20°F/10°C of the set temperature only during filter cycles. *SLP* will display when water temp is not current, and will alternate with current water temp when the pump is running.

Mode 300, 300F

- Depending on system configuration, mode changing may not be available and will be locked in Standard Mode.
- Mode is changed by pressing “Temp,” then “Light”.
- STANDARD Mode maintains set temperature. *SL* will be displayed momentarily when you switch into Standard Mode.
- ECONOMY Mode heats the spa to the set temperature only during filter cycles. *Ecn* will display when water temp is not current, and will alternate with water temp when the pump is running.
- SLEEP Mode heats the spa to within 20°F/10°C of the set temperature only during filter cycles. *SL* will display when water temp is not current, and will alternate with water temp when the pump is running

FILTER CYCLES

Preset Filter Cycles 500Z

- The first preset filter cycle begins 6 minutes after the spa is energized. The second preset filter cycle begins 12 hours later. Filter duration is programmable for 2, 4, 6, or 8 hours or for continuous filtration (indicated by *FLC*). The default filter time is 2 hours.
- To program, press “Temp,” then “Jets 1.” Press “Temp” to adjust. Press “Jets 1” to exit programming.
- For non-circ systems, low-speed pump 1 and the ozone generator (if installed) run during filtration.

- For circulation systems, the circ pump and the ozone generator (if installed) run 24 hours. In hot environments, the circ pump may turn off for 30 minute periods, except during filter cycles. At the beginning of each filter cycle all other equipment will run briefly to purge the plumbing.

Preset Filter Cycles 500SZ

- The first preset filter cycle begins 6 minutes after the spa is energized. The second preset filter cycle begins 12 hours later. Filter duration is programmable for 2, 4, 6, or 8 hours or for continuous filtration (indicated by *FLC*). The default filter time is 2 hours for non-circ systems and 4 hours for circ systems.
- To program, press “Warm” or “Cool,” then “Jets 1.” Press “Warm” or “Cool” to adjust. Press “Jets 1” to exit programming.
- In hot environments, the circ pump may turn off for 30 minute periods, except during filter cycles. At the beginning of each filter cycle all other equipment will run briefly to purge the plumbing

Preset Filter Cycles 500DZ

- The first preset filter cycle starts at 8:00 AM and ends at 10:00 AM. The second preset filter cycle starts at 8:00 PM and ends at 10:00 PM.
- For non-circ systems, low-speed pump 1 and the ozone generator (if installed) run during filtration.
- For circulation systems, the circ pump and the ozone generator (if installed) run 24 hours. In hot environments, the circ pump may turn off for 30 minute periods, except during filter cycles. At the beginning of each filter cycle, all other equipment will run briefly to purge the plumbing.

Preset Filter Cycles 300F (Software v. 41)

- The first preset filter cycle begins 6 minutes after the spa is energized. The second preset filter cycle begins 12 hours later.
- Filter duration is programmable for 1, 2, 3, 4, 5, 6, 7, or 8 hours. The default filter time is 1 hour.
- To program, press “Temp,” then “Jets.” Press “Temp” to adjust. Press “Jets” to exit programming.

Preset Filter Cycles 300, 300F (Software v. 38)

- The first preset filter cycle begins 6 minutes after the spa is energized. The second preset filter cycle begins 12 hours later.
- For 300-series systems, filter duration is programmable for 2, 4, 6, or 8 hours or for continuous filtration (indicated by *F*⏏). The default filter time is 2 hours.
- For 300F-series systems, filter duration is programmable for 1, 2, 3, 4, 5, 6, 7, or 8 hours or for continuous filtration (indicated by *F*⏏). The default filter time is 1 hour.
- To program, press "Temp," then "Jets." Press "Temp" to adjust. Press "Jets" to exit programming.

Optional Filter Cycle Programming 500DZ

- You are not required to change the filter cycles, but if you wish to, press "Time," "Mode/Prog," "Mode/Prog" within 3 seconds. SET START FILTER 1 (AM) will appear. Press "Warm" or "Cool" to reset the filter start time.
- Press "Mode/Prog" to see SET STOP FILTER 1 and adjust the time with "Warm" or "Cool" as done above. Press "Mode/Prog" to see SET START FILTER 2 (PM) and proceed as above. Press "Mode/Prog" to see SET STOP FILTER 2 and proceed as above. Press "Mode/Prog" to confirm.

LOCKING THE PANEL 500DZ

- Press "Time," "Blower," and "Warm" within 3 seconds. The Panel is now locked. To unlock the panel, press the "Time," "Blower," and "Cool" within 2 seconds.
- Note: On some systems, "Jets 1," instead of "Blower," is used in Lock/Unlock sequences.

LOCKING THE TEMPERATURE 500DZ

- Press "Warm," "Time," "Blower," and "Warm" within 3 seconds. The "Warm" and "Cool" buttons are now disabled. To unlock the temperature, press "Time," "Blower," and "Cool" within 2 seconds.
- Note: On some systems, "Jets 1," instead of "Blower," is used in Lock/Unlock sequences.

OZONE

For non-circ systems (if installed) runs during filtration.
For circulation systems (if installed) runs 24 hours.

EL and GL Series Mach 3 -- Persistent Memory & Power Up

This document applies when using ML Series panels with any EL or GL Mach 3 series system.

EL - GL, ABOUT PERSISTENT MEMORY

Any time you change DIP Switches or Software Configuration Settings that affect parameters the user can change (any filter settings, set temperature default, Celsius vs Fahrenheit, 12-hour vs 24-hour time, reminders suppression, etc), you must reset Persistent Memory for your DIP Switch or Software Configuration Settings changes to take effect. You should also reset Persistent Memory after loading a new file into a board (using the ESM, purchased separately).

To reset Persistent Memory:

- Power down.
- Set A12 ON (See illustration below).
- Power up.
- Wait until “P” or “PRIMING MODE” is displayed on your panel. Note: If “CFE” appears see section below.
- Set A12 OFF. (This can be done safely with power on if you use a non-conductive tool such as a pencil to push the switch back to the OFF position. Otherwise, power down before setting A12 OFF)
- Power up again (if you powered down in the previous step).
- For all other power ups, leave A12 OFF.

About Persistent Memory and Time of Day Retention:

This system uses memory that doesn't require a battery to store a variety of settings. What we refer to as Persistent Memory stores all the User Preferences, as well as all the filter settings, the set temperature, and the heat mode.

Persistent Memory is not used for Time of Day. Time of Day needs to be “kept running” (not just stored) while the power is off, so a separate Real Time Clock feature (on all models except the EL1000) keeps track of Time of Day while the unit is off. Time of Day Retention, and Time of Day Retention alone, is controlled by the J91 jumper. J91 must be set according to main system panel used.

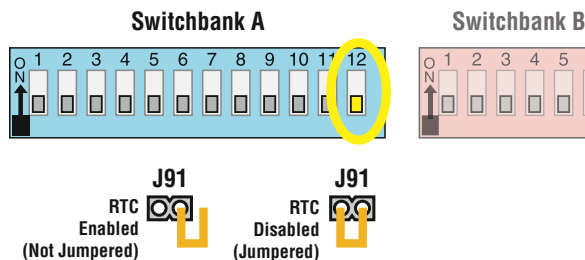

POWER UP DISPLAY SEQUENCE, SOFTWARE ID

CFE message on power up:

If “CFE” appears before (and instead of) “P” or “PRIMING MODE”, you have not configured DIP Switches and/or Software Configuration Settings in a valid manner. This must be corrected before you can reset Persistent Memory.

The switch numbers, jumpers, or configuration settings displayed after “CFE” are ones with which the system has found a configuration problem. For example:

- “CFE A5 B2” would mean that the combination of how you've set A5 and how you've set B2 is not supported on this system.
- “CFE J99” would mean that there is a problem with jumper J99
- “CFE P3 1 BL 1” would mean that the combination of how you've set pump 3 for 1-speed and blower for 1-speed is not supported on this system.
- “CFE P3 1 BL 2” would mean that the combination of how you've set DIP switches which have been assigned to pump 3 and blower is not supported on this system.

Power Up Display Sequence

Upon power up, you should see the following on the display:

- Three numbers in a row, which are the SSID (the System Software ID). The third display of these numbers is the Software Version, which should match the version of your system. For example, if these three numbers are 100 134 26, that is a Mach 3 EL8000 at version 26.
- If there is a Configuration Error, the CFE message (see above) will appear at this point (and none of the messages below will display). Otherwise what comes next is:
- An indication of either the input voltage detected (EL1000/EL2000), or the heater wattage range supported (EL8000/GL2000/GL8000).
 - Heater wattage display: “1-3” means the system supports a heater from 1 kW to 3 kW. “3-6” means the system supports a heater from 3 kW to 6 kW. “3-3” means the system supports a 3 kW heater only. (These ranges may be modified slightly in the case of special heaters, which the next bullet covers.)
- Input voltage display: A system showing “240” supports 3 kW to 6 kW heaters. A system showing “120” supports the very same heaters, although at 120V those heaters will function at only 1/4 of their 240V rated wattage. (The system shows only either “240” or “120” as a general indication of input voltage; it does not show the actual input voltage.)
- If your system is using a special type of heater, a display such as “H B” may appear next. If your system is using the generic Balboa heater, no heater type display will appear.
- “P” or “PRIMING MODE” will appear to signal the start of Priming Mode.

At this point, the power up sequence is complete. Refer to the User Guide for the ML Series panel on your system for information about how the spa operates from this point on.

VS-GS Persistent Memory with VL Panels

Any time you change a DIP Switch, other than A1, you must reset Persistent Memory for your new DIP Switch Settings changes to take effect. If you do not reset Persistent Memory, your system may function improperly.

To reset Persistent Memory:

- Power down by disconnecting power source from spa.
- Put a jumper across J43, covering both pins. (See illustration below)
- Power up by connecting power source to spa.
- Wait until “P-” is displayed on your panel.
- Power down again.
- Remove jumper from J43 (May also move to cover 1 pin only)
- Power up again.

About Persistent Memory and Time of Day Retention:

This system uses memory that doesn't require a battery to store a variety of settings. What we refer to as Persistent Memory stores the filter settings, the set temperature, and the heat mode.

Persistent Memory is not used for Time of Day. Only models with a Serial Deluxe panel installed (VS5xxDZ and GS5xxDZ) can display the time. However, during power loss to the spa, the system will lose the correct time, and reset to 12:00 PM when power is restored.

Power Up Display Sequence

Upon power up, you should see the following on the display:

- Three numbers in a row, which are the SSID (the System Software ID). The third display of these numbers is the Software Version, which should match the version of your system. For example, if these three numbers are 100 67 38, that is a VS511SZ at version 38.
- Displayed next is: “24” (indicating the system is configured for a heater between 3 and 6 kW) or “12” (indicating the system is configured for a heater effectively* between 1 and 3 kW). “24” should appear for all VS models running at 240VAC. “12” should appear for all VS models running at 120VAC, as well as all GS models. (*A heater which is rated at 4 kW at 240VAC will function as a 1 kW heater at 120VAC.)
- “P-” will appear to signal the start of Priming Mode.

At this point, the power up sequence is complete. Refer to the Reference Card for the VS or GS System model of your spa for information about how the spa operates from this point on, including how to adjust the Time of Day if using a Serial Deluxe style panel.

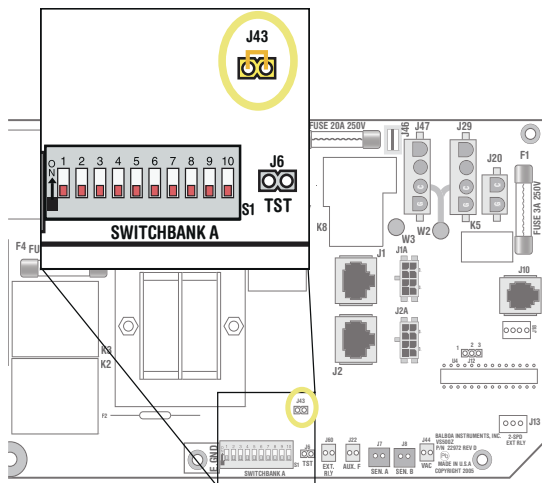

J43 on VS5xxZ and VS300 Series Main Board Shown.
J43 on GS5xxZ Series is located in approximately the same position.

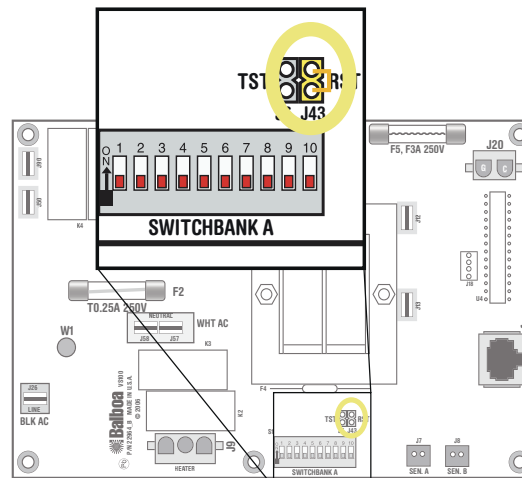

J43 on VS100/GS100 Series Main Board Shown.

Testing the Circuit Board Output

BALBOA'S QUICK TEST™ TEST KIT

If your topside control panel is working properly, but a pump, blower, or other device does not activate when its panel button is pressed, further diagnosis is easily accomplished with the Balboa Quick Check, which is designed to test output voltage on a variety of Balboa systems. The following system outputs can be tested using the Balboa Quick Check:

- 120 VAC or 240 VAC -- 2-speed pump
- 120 VAC or 240 VAC -- 1-speed pump
- 120 VAC or 240 VAC -- blower (with or w/o variable speed)
- 120 VAC or 240 VAC -- ozone generators
- 12 VAC -- spa light
- 120 VAC -- spa light (with Spa Light Adapter)
- 12 VAC -- perimeter light (with Perimeter Light Adapter)

The Balboa Quick Check Test Kit is especially useful for testing variable speed blowers and dimmable spa lights. Because these outputs use a device on the circuit board called a triac, no voltage can be measured unless a load exists. The Quick Check not only supplies a small load, but also indicates if voltage is present.

The 4-prong connector is used to test pumps, blowers, ozone generators, and by using the Spa Light Adapter, 120 VAC spa light output. The 2-prong connector is used to test the output for the 12 VAC spa light. Also included in the kit is a Perimeter Light Adapter, which can be used to test the 12 VAC perimeter light output.

Balboa QuickCheck™
Part No. 70002



TO USE THE BALBOA QUICK CHECK

- Turn off the power at the house breaker box.
- Unplug the device in question, and plug the Quick Check in its place.
- Restore power to the spa and press the appropriate panel button again. If the Quick Check's light appears, the device in question is receiving voltage.
- An ordinary multi-meter can also be used to check for proper output voltage, except when working with a variable-speed blower or a dimmable spa light. In these cases, a component on the circuit board called a "triac" needs to be under a small load to test output voltage.

NOTE: If a small load is not applied to these systems, voltage indications of up to 240 volts AC can be seen when measuring output voltage, even if the component is not activated.

- Even if the system is not equipped with a blower triac, the best way to verify voltage output is with the Balboa Quick Check.
- If the Quick Check light does not appear after pressing the appropriate panel button, trace the wires from the corresponding connector in the system box back to the circuit board.
- Probe these connections at the circuit board after activating the function with the topside control panel.
- If you do not have correct voltage, double check the input voltage before you replace the circuit board.
- If you do have correct voltage at the circuit board, turn off the system power and check for a blown in-line fuse. Blowing the in-line fuse or the power input fuse is usually a symptom of a faulty pump, blower, or a short in the wiring to one of those devices.
- If the fuse is good, then replace the output connector.
- If the high-speed pump comes on when the system calls for heat or when the system goes into a filter cycle, the pump is most likely wired backwards. Verify that the black (low speed) & red (high speed) wires are not switched in the amp connector or the pump itself.
- Always check to make sure all devices are plugged into the proper location.

NOTE: If the spa light output is not detected with the Balboa Quick Check, be sure to check continuity of the light fuse on the circuit board.

Testing the Sensor Set

1. Check sensor wires for cracks or damage that may indicate the presence of a rodent.
2. Inspect the connections of both sensors on the circuit board. The plugs must be clean.
3. If the sensors are not totally failing but are showing excessive ($2^{\circ}\text{F}/1.0^{\circ}\text{C}$ or more) difference between the two sensors when not heating (a possible cause of Sn/SnS/SENSOR SYNC, HL/HFL/HTR FLOW LOW, and LF/LOW/FLOW/messages), do the following:
 - Note which sensor is reading consistently higher (A vs B or t vs H).
4. Unplug the two sensors from the circuit board and exchange their positions (i.e., plug the one that was in the "Sen. A" jack into the "Sen. B" jack and vice versa).
5. Press a panel button if any "stray" faults appeared during the process. (Stray faults are normal when sensors are unplugged then plugged back in while the system is running.)
6. Within a minute or so, see if the same or other sensor is now reading consistently higher:
 - If the same sensor (A vs B or t vs H) is reading higher after the sensor interchange, the problem is on the circuit board. Replace the circuit board.
 - If the opposite sensor is now reading higher, the problem is with the sensor(s). Replace the sensor set.
**If you wait more than 2 minutes after plugging the sensors back in, heating may start (even outside a filter in Economy or Sleep mode) due to a stray Cd/CLd/COLD WATER condition usually detected when sensors are being plugged in while the system is running.*
7. If there is a message indicating an open or faulty sensor:
 - Unplug the sensor set (but leave the original sensors in the heater) and plug in the test sensor set. Put both sensors into the same cup of warm water (ideally above the set temperature, so the spa won't try to heat during this test, as there is no heater protection during this test) and verify that they read the same temperature (within $1^{\circ}\text{F}/0.5^{\circ}\text{C}$).
 - If the problem is solved, replace the sensor set. If the problem is not solved, do not replace the sensor set.
 - Plug in the original sensor set to verify that there is not a connection problem.
 - If the problem continues after following the above steps, then replace the circuit board.

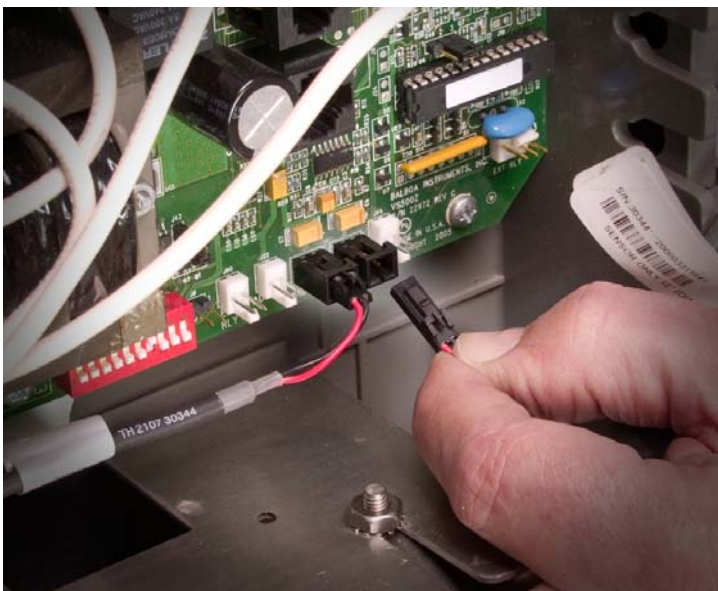

Changing a System Circuit Board

Important!

Be sure to turn the power off before replacing any component, **especially a circuit board**.

Important!

DO NOT REMOVE AND REPLACE THE CIRCUIT BOARD UNLESS THE FAULT HAS POSITIVELY BEEN DETERMINED TO BE THE CIRCUIT BOARD.

HOW TO REMOVE A SYSTEM CIRCUIT BOARD

NOTE: Before you begin, labeling all wires to be removed may help speed up reinstallation. The wiring diagram should always be used to ensure proper wire placement.

- Shut OFF line power to the spa at the main circuit breaker panel. Do not attempt to service a spa without shutting off the power. Serious injury or damage may result.
- Disconnect all wires and slip-on connectors as necessary to remove the board.
- Remove all the screws which mount the board to the system enclosure.
- Remove the board from the plastic stand-offs by gently squeezing the locking flange on each stand-off with a pair of pliers. The board should now be free and can be removed from the system box.

HOW TO REPLACE A SYSTEM CIRCUIT BOARD

- Check all jumpers and dip switch positions on the new board. Make sure they are in the same position as the old board.
- Make sure the new board snaps in place on the plastic stand-offs. Use care to be sure the connectors on the right side of the board clear the enclosure openings as the board is installed.
Caution: Do Not Overtighten this screw.
- Install all screws which mount the board to the system enclosure.
- Reconnect all wires and slip-on connectors.
- Restore power to the spa at the main breaker.
- Test to make sure all functions work correctly.

Important

DO NOT REMOVE AND REPLACE THE CIRCUIT BOARD UNLESS YOU HAVE TESTED ALL OTHER COMPONENTS AND PROVEN THAT THE CIRCUIT BOARD IS ACTUALLY CAUSING THE PROBLEM.

VS500 Board

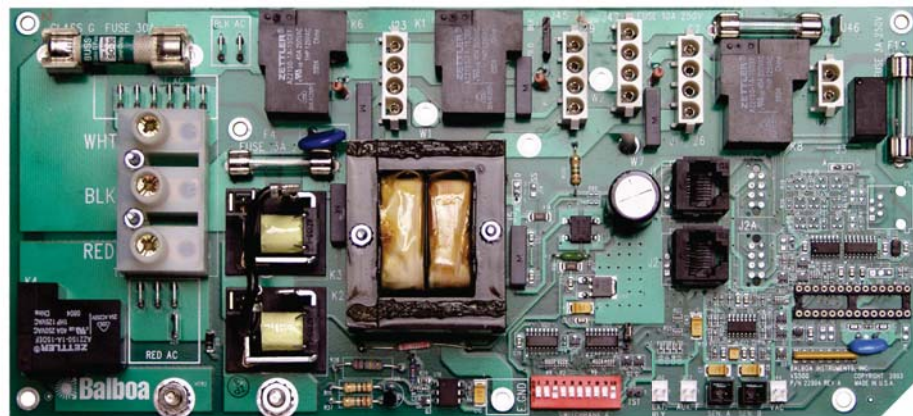

Removing the Heater Assembly from a Spa System

Note: Be careful when removing a heater assembly from a spa plumbing system. Water may splash out under pressure.

Water under pressure in the plumbing may splash out, and onto the system's electronic board. Do not remove the system door until the water has been drained from the heater assembly housed in the system.

1. Turn off the main power.
2. Close off the slice valves (or, ball valves) adjacent to the heater assembly.
3. Once the valves are closed, slowly crack the heater assembly end tubes until water flows out. If the connectors are on too tight, it may be necessary to loosen the Phillips screws that hold the connectors together. Once the water has been drained, continue.



Remove both nuts that secure the element in place.

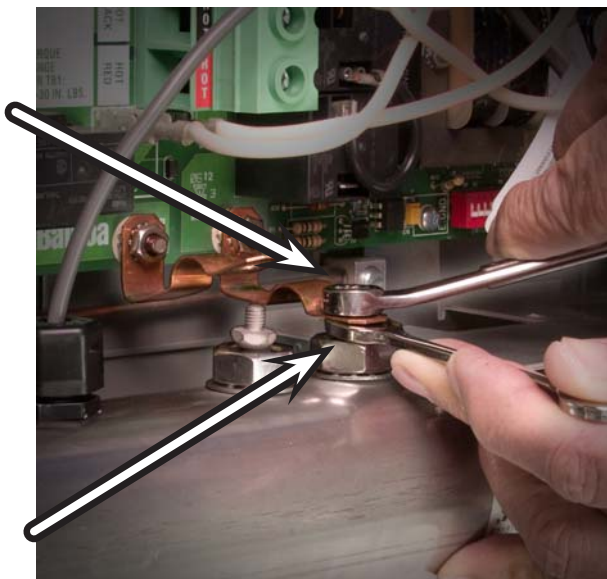

Keep the lower nut from turning by supporting it with another end-wrench

4. Remove the system door cover.
5. Remove the nuts securing the copper straps to the heater assembly's terminal connectors. **Be sure to use a supporting end wrench on the lower nut.** Otherwise, excessive torque may occur on the straps and put undue stress on the PCB.
6. Remove the heating assembly sensor wires and replace if necessary.
7. Remove both nuts that secure the element in place.
8. Remove the heater assembly

Panel Message Reference Guide

Message	Meaning / Frequency	Action Required
-- --- --F or --E	Temperature not current in Economy or Sleep mode.	In Economy or Sleep mode, the pump may be off for hours outside a filter cycle. If you wish to see the current spa temperature, either switch to Standard mode or turn Jets 1 on for 2 minutes. Please see "Diagnosing Topside Control Panels". (Page 16)
CFE	Configuration error. Spa cannot start up.	Please see "Diagnosing Topside Control Panels". (Page 16)
CHANGE MINERAL CARTRIDGE	As needed [3]	Install new Mineral cartridge. Reminder, Suppress in User Preferences. [2]
CHECK PH	Every 7 days [3]	Test and adjust pH chemical levels per manufacturer's instructions. Reminder, Suppress in User Preferences. [2]
CHK SANITIZER	Every 7 days [3]	Test and adjust sanitizer chemical levels per manufacturer's instructions. Reminder, Suppress in User Preferences. [2]
CHKSUM FAIL	Firmware install problem.	Contact Balboa if message appears on more than one power up.
CLEAN COVER	Every 180 days [3]	Clean and condition cover per manufacturer's instructions. Reminder, Suppress in User Preferences. [2]
CLEAN FILTER	Every 30 days [3]	Remove, clean, and reinstall filter per manufacturer's instructions. Reminder, Suppress in User Preferences. [2]
CONFIG ERROR	System configured incorrectly. Menu panel displays errors.	Contact Balboa. Please see "Diagnosing Topside Control Panels". (Page 16)
E-E	Firmware install problem.	Contact Balboa if message appears on more than one power up. Please see "Diagnosing Topside Control Panels". (Page 16)
dr (ML Panels)	Inadequate water detected in heater.	Check water level in spa. Refill if necessary. If the water level is okay, make sure the pumps have been primed. Press any button to reset.
dr (VL panels)	Possible inadequate water, poor flow, or air bubbles in detected in the heater. Spa is shut down for 15 minutes.	If water level is normal, make sure all pumps have been primed. Press any button to reset. This message will reset within 15 minutes.
DRAIN WATER	Every 90 days [3]	Drain and refill spa per manufacturer's instructions. Reminder, Suppress in User Preferences. [2]

[1] On some systems even when spa is shut down, some equipment may occasionally turn on to continue monitoring temperature or if freeze protection is needed.

[2] Please see the User Manual of the specific panel that the Reminders need to be suppressed.

[3] This is a Reminder Message.

Note: All Messages may not appear on your panel.

<i>DRAINING</i> <i>drn</i>	The pump is on during Standby Mode to assist in draining the spa.	Press "Jets 1" to turn off the pump when water has drained (or power off the spa.)
<i>dry</i> <i>dy</i>	Inadequate water detected in heater. (Displays on third occurrence of "dr" message.) Spa is shut down. [1]	Follow action required for <i>dr</i> message. Spa will not automatically reset. Press any button to reset manually.
<i>Ec</i> <i>Ecn</i> Economy	The spa is operating in Economy Mode.	"Ecn" will appear solid on the display when the temperature is not current. "Ecn" will alternate with the temperature when the temperature is current.
<i>FC</i>	As needed.	Continuous Filtration is on.
<i>FREEZE COND</i>	"Ice" - Potential freeze condition detected.	No action required. The pumps and the blower will automatically activate regardless of spa status.
<i>GF 1</i> <i>GFCI FAILURE</i>	Spa could not trip GFCI.	Continued operation may be unsafe.
<i>HEATER DRY SERVICE REQ</i>	Inadequate water detected in heater. (Displays on third occurrence of the above message.) Spa is shut down. [1]	Follow action required for the above message. Spa will not automatically reset. Highlight and press to reset.
<i>HEATER MAY BE DRY- WILL RETEST SHORTLY</i>	Inadequate water detected in heater.	Check water level in spa. Refill if necessary. If the water level is okay, make sure the pumps have been primed. Press any button to reset.
<i>HL</i> <i>HFL</i> <i>HTR FLOW LOW</i>	A substantial difference between the temperature sensors was detected. This could indicate a flow problem.	Check water level in spa. Refill if necessary. If the water level is okay, make sure the pumps have been primed. Press any button to reset.
<i>HH</i>	"Overheat" - The spa has shut down. [1] One of the sensors has detected 118°F/47.8°C at the heater.	DO NOT ENTER THE WATER. Remove the spa cover and allow water to cool. Once the heater has cooled, reset by pushing any button.
<i>HOL</i> <i>HOT-CALL SVC</i>	A pump appears to have been stuck on the last time spa was powered down.	POWER DOWN SPA IMMEDIATELY. DO NOT ENTER THE WATER.
<i>HTR TEMP LMT</i>	"Overheat" - The spa has shut down. [1] On some systems, an alarm may sound. One of the sensors has detected 118°F (approx. 47.8°C) at the heater.	DO NOT ENTER THE WATER. Remove the spa cover and allow water to cool. Once the heater has cooled, reset by pushing any button. If spa does not reset, test sensors.

[1] On some systems even when spa is shut down, some equipment may occasionally turn on to continue monitoring temperature or if freeze protection is needed.

[2] Please see the User Manual of the specific panel that the Reminders need to be suppressed.

[3] This is a Reminder Message.

Note: All Messages may not appear on your panel.

Panel Message Reference Guide (cont.)

<i>IC ICE</i>	"Ice" - Potential freeze condition detected.	No action required. The pumps and the blower will automatically activate regardless of spa status.
<i>LF LOW FLOW</i>	Persistent low flow problems. (Displays on the fifth occurrence of the "Heater Flow Low" message within 24 hours.) Heater is shut down, but other spa functions continue to run normally.	Follow action required for "HFL" or "HL" message. Heating capacity of the spa will not reset automatically; you may press any button to reset.
<i>NEW FILTER</i>	Every 365 days [3]	Install new filter. Reminder, Suppress in User Preferences. [2]
<i>OH OHS</i>	"Overheat" - The spa has shut down. [1] One of the sensors has detected that the spa water is 110°F/43.5°C.	DO NOT ENTER THE WATER. Remove the spa cover and allow water to cool. At 107°F/41.7°C, the spa should automatically reset. If spa does not reset, test sensors.
<i>OHH</i>	"Overheat" - The spa has shut down. On some systems, an alarm may sound. One of the sensors has detected 118°F (approx. 47.8°C) at the heater.	DO NOT ENTER THE WATER. Remove the spa cover and allow water to cool. Once the heater has cooled, reset by pushing any button. Test sensors.
<i>PERSIST FAIL</i>	Hardware failure.	Contact Balboa if message appears on more than one power up.
<i>PH IS HIGH LOWER PH PHH</i>	pH is high.	Add pH reducer according to manufacturer's instructions.
<i>PH IS LOW RAISE PH PHL</i>	pH is low.	Add pH increaser according to manufacturer's instructions.
<i>P_r PRIMING MODE TAKES 4 MIN</i>	When your spa is first actuated, it will go into Priming mode.	See the M-7 Installation Instruction Manual for complete instructions on Power-up and Pump Priming. The Priming mode will last for up to 4 minutes and then the spa will begin to heat and maintain the water temperature in the Standard mode.
<i>PSE</i>	Hardware failure.	Contact Balboa if message appears on more than one power up.
<i>r_{CR}</i>	As needed [3]	Install new Mineral cartridge. Reminder, Suppress in User Preferences. [2]
<i>r_{CH}</i>	Every 365 days [3]	Install new filter. Reminder, Suppress in User Preferences. [2]
<i>r_{CL}</i>	Every 30 days [3]	Remove, clean, & reinstall filter per manufacturer's instructions. Reminder, Suppress in User Preferences. [2]

[1] On some systems even when spa is shut down, some equipment may occasionally turn on to continue monitoring temperature or if freeze protection is needed.

[2] Please see the User Manual of the specific panel that the Reminders need to be suppressed.

[3] This is a Reminder Message.

Note: All Messages may not appear on your panel.

<i>rCD</i>	Every 180 days [3]	Clean & condition cover per manufacturer's instructions. Reminder, Suppress in User Preferences. [2]
<i>rdr</i>	Every 90 days [3]	Drain and refill spa per manufacturer's instructions. Reminder, Suppress in User Preferences. [2]
<i>rPH</i>	Every 7 days [3]	Test and adjust pH chemical levels per manuf. instructions. Reminder, Suppress in User Preferences. [2]
<i>rSA</i>	Every 7 days [3]	Test and adjust sanitizer chemical levels per manufacturer's instructions. Reminder, Suppress in User Preferences. [2]
<i>rEC</i> <i>RTC FAILURE</i>	Hardware failure.	Contact Balboa.
<i>rEG</i>	Every 30 days [3]	Test & reset RCD per manufacturer's instructions. [2]
<i>rEr</i>	Every 180 days [3]	Clean and condition wood per manufacturer's instructions. [2]
<i>SA</i>	Spa is shut down. [1] The sensor that is plugged into the Sensor "A" jack is not working.	If the problem persists, contact Balboa. (May appear temporarily in an overheat condition.) See "Testing the Sensor Set". (Page 41)
<i>Sb</i>	Spa is shut down. [1] The sensor that is plugged into the Sensor "B" jack is not working.	If the problem persists, contact Balboa. (May appear temporarily in an overheat condition.) See "Testing the Sensor Set". (Page 41)
<i>SAH</i> <i>SANITIZER</i> <i>HIGH</i>	Sanitizer is high.	Remove spa cover and allow sanitizer to dissipate.
<i>SAL</i> <i>SANITIZER</i> <i>LOW</i>	Sanitizer is low.	Add sanitizer according to manufacturer's instructions.
<i>Sby</i>	Standby Mode has been activated by pressing a button combination on the user panel.	Press any button, except "Jets 1", to leave Standby Mode and return to normal operation.
<i>SE</i>	The spa is operating in Standard-in-Economy Mode.	Operates the same as Standard mode, then reverts to Economy mode after 1 hour. Press "Mode" to switch directly to Economy mode.
<i>SENSOR A</i> <i>SERVICE REQ</i>	Spa is shut down. [1] The sensor that is plugged into the Sensor "A" jack is not working.	Test sensor, and replace if bad. Please see Testing the Sensor Set. (Page 41)

[1] On some systems even when spa is shut down, some equipment may occasionally turn on to continue monitoring temperature or if freeze protection is needed.

[2] Please see the User Manual of the specific panel that the Reminders need to be suppressed.

[3] This is a Reminder Message.

Note: All Messages may not appear on your panel.

Panel Message Reference Guide (cont.)

<i>SENSOR B SERVICE REQ</i>	Spa is shut down. [1] The sensor that is plugged into the Sensor "B" jack is not working.	Test sensor, and replace if bad. Please see Testing the Sensor Set. (Page 41)
<i>SENSOR SYNC Sn SnS</i>	Sensors are out of balance. If this is alternating with the temperature, it may just be a temporary condition. If the display shows only this message (periodically blinking), the spa is shut down. [1]	Test sensor, and replace if bad. Please see Testing the Sensor Set. (Page 41)
<i>SLP</i>	Sleep Mode has been activated by pressing a button combination on the user panel.	"SLP" will appear solid on the display when the temperature is not current. "SLP" will alternate with the temperature when the temperature is current.
<i>SnA</i>	Spa is shut down. The sensor that is plugged into the Sensor "A" jack is not working.	Test sensor, and replace if bad. Please see Testing the Sensor Set. (Page 41)
<i>Snb</i>	Spa is shut down. The sensor that is plugged into the Sensor "B" jack is not working.	Test sensor, and replace if bad. Please see Testing the Sensor Set. (Page 41)
<i>SPA TEMP LMT</i>	"Overheat" - The spa has shut down. [1] One of the sensors has detected that the spa water is 110°F (approx. 43.3°C).	DO NOT ENTER THE WATER. Remove the spa cover and allow water to cool. At 107°F (approximately 41.7°C), the spa should automatically reset. If spa does not reset, shut off the power to the spa.
<i>STANDBY MODE</i>	Standby Mode has been activated by pressing a button combination on the user panel.	Press any button to leave Standby Mode and return to normal operation.
<i>Std</i>	The spa is operating in Standard Mode.	Temperature display is current after pump has been running for at least 2 minutes.
<i>StU STUCK ON</i>	A pump appears to be stuck on, causing the water temperature to creep up, possibly to hazardous levels.	POWER DOWN SPA IMMEDIATELY. DO NOT ENTER THE WATER.
<i>TEST GFCI</i>	Every 30 days [3]	Test & reset per manufacturer's instructions. Reminder, Suppress in User Preferences. [2]
<i>TREAT WOOD</i>	Every 180 days [3]	Clean and condition wood per manufacturer's instructions. Reminder, Suppress in User Preferences. [2]

[1] On some systems even when spa is shut down, some equipment may occasionally turn on to continue monitoring temperature or if freeze protection is needed.

[2] Please see the User Manual of the specific panel that the Reminders need to be suppressed.

[3] This is a Reminder Message.

Note: All Messages may not appear on your panel.