

CS7100B SERIES

Operation Manual



BALBOA™ Series by HYDROQUIP™

Introduction

This manual covers electrical and installation details on the following product series. Some photos and instructions may not apply to the product you have purchased.

-U Series "Fixed" Heater configuration: This series is designed to fit the most common heater position. Depending upon the actual control being replaced, you may still need to modify the plumbing to achieve proper alignment.

-US Series "Slide" Heater configuration: This series is designed to allow the heater to be positioned within 20" of the control to provide an installation with a minimum of plumbing modifications. Depending upon the actual control being replaced, you may still need to modify the plumbing to achieve proper alignment.

-VH Series "Versi-Heat" Heater configuration: This series is designed to allow the heater to be positioned within 60" of the control to provide an installation where there may not be enough room in the immediate equipment area and to minimize plumbing modifications. Depending upon the actual control being replaced, you may still need to modify the plumbing to achieve proper alignment.

-LH Series "Less Heater" configuration: This series allows the use of customer supplied custom heater configurations which may not have been available from Hydro-Quip. Please refer to the "LH" wiring diagram enclosed with the "LH" wiring harness for specific wiring connections and details NOT covered within this manual.

Contents

Important Safety Instructions.....	3-4
Electrical Installation.....	5-7
GFCI Wiring Detail.....	7
Heater Installation.....	8
Plumbing Considerations.....	9
Temperature Sensor Installation.....	9
Optional Heaters.....	10
Optional Cords.....	10
Power Connection.....	11
Cord Connections.....	12
System Plug Pinouts.....	12
Spa Light.....	12
Equipment Connections.....	13
Circuit Board Configurations.....	14
System Start-Up.....	15
Filtration Cycles.....	15
Spa Side Control Operation.....	16
Operational Considerations.....	17
Spa Side Messages.....	18
TroubleShooting	18-19
Fixed Heater Pressure Switch Adjustment	20
Slide/Versi-Heat Pressure Switch Adjustment.....	21
System Data Label.....	22
Warranty Information.....	22

IMPORTANT SAFETY INSTRUCTIONS

- ! **DANGER** To reduce the risk of injury, do not permit children to use this product unless they are closely supervised at all times.
- ! **WARNING - RISK OF CHILD DROWNING.** Extreme caution must be exercised to prevent unauthorized access by children. To avoid accidents, ensure that children cannot use a spa or hot tub unless they are supervised at all times.
- ! **DANGER** To reduce the risk of injury to persons, do not remove suction fittings.
- ▶ Spa location must accommodate sufficient drainage of water around the base of the structure, as well as the power source compartment.
- ▶ Prolonged immersion in water that is warmer than normal body temperature can result in a dangerous condition known as HYPERTHERMIA. The causes, symptoms, and effects of hyperthermia may be described as follows: Hyperthermia occurs when the internal temperature of the body reaches a level several degrees above the normal body temperature of 98.6°F. The symptoms of hyperthermia include dizziness, fainting, drowsiness, lethargy, and an increase in the internal temperature of the body. The effects of hyperthermia include (1) unawareness of impending hazard, (2) failure to perceive heat, (3) failure to recognize the need to exit spa, (4) physical inability to exit spa, (5) fetal damage in pregnant women, (6) unconsciousness resulting in danger of drowning. **WARNING** The use of alcohol, drugs or medication can greatly increase the risk of fatal hyperthermia in hot tubs and spas.
- ! **DANGER - RISK OF ELECTRICAL SHOCK.**
A spa may be installed within 5 feet of metal surfaces if each metal surface is permanently connected by a solid copper conductor attached to the wire connector on the terminal box . Refer to NEC and local codes in effect at the time of installation.)
- ▶ A bonding lug is provided on the control box to permit connection of a solid copper bonding conductor between this point and any equipment, metal enclosures of electrical equipment, metal water pipe, or conduit within 5 feet (1.5m) of the unit as needed to comply with local requirements.
- ▶ Bond accessible metal to the dedicated connector on the equipment grounding bus, bond the equipment ground bus to the local common bonding grid as part of the installation in the form of (1) a reinforced concrete slab for support, (2) a ground plate provided beneath the hot tub or spa, or (3) a permanent ground connection that is acceptable to the local inspection authority.
- ! **DANGER RISK OF ELECTRICAL SHOCK.** Do not permit any electrical appliance, such as a light, telephone, radio, or television, within 5 feet (1.5m) of a spa or hot tub.

To reduce the risk of injury:

- ▶ The water in a spa or hot tub should never exceed 104°F (40°C). Water temperatures between 100°F (38°C) and 104°F (40°C) are considered safe for a healthy adult. Lower water temperatures are recommended for extended use (exceeding 10-15 minutes) and for young children.
- ▶ Excessive water temperatures have a high potential for causing fetal damage during the early months of pregnancy, pregnant or possibly pregnant women should limit spa or hot tub water temperatures to 100°F(38°C).

Before entering the spa or hot tub, the user should measure the water temperature with an accurate thermometer.

The use of alcohol, drugs, or medication before or during spa or hot tub use may lead to unconsciousness with the possibility of drowning.

Persons suffering from obesity or with a medical history of heart disease, low or high blood pressure, circulatory system problems, or diabetes should consult a physician before using a spa or hot tub.

Persons using medication should consult a physician before using a spa or hot tub since some medication may affect heart rate, blood pressure, and circulation.

For Cord and Plug Connected Units

Must be connected to a grounded, grounding type receptacle only. NEVER connect the spa to an extension cord.

Do not bury the cord.

For Permanently Installed Units

A terminal marked "G" or "ground" is provided in the wiring box located inside the equipment compartment. To reduce the risk of electric shock, connect the terminal or connector to the grounding terminal of your electrical service or supply panel with a continuous green insulated copper wire in accordance with National Electric Code Table 250-95 and any other local codes in effect at the time of the installation.

For Permanently Installed Units not Provided with an Internal Disconnecting Method

The electrical supply for this product must include a suitably rated switch or circuit breaker to open all ungrounded supply conductors to comply with Section 422-30 of the National Electric Code, ANSI/NFPA 70 1987. The disconnecting means must be readily accessible to the tub occupant but installed at least 5 feet (1.5m) from the tub water.

For Units with Gas Heaters

WARNING - Do not install indoors. This unit uses a gas heater that requires proper ventilation and is intended for outdoor use only.

High Voltage Warning

**HIGH VOLTAGE CAN SERIOUSLY INJURE OR KILL!
ONLY EXPERIENCED TECHNICIANS SHOULD SERVICE THIS EQUIPMENT.
DO NOT** remove the protective covers from any electrical enclosure, or attempt to service any related electrical device, unless you are a qualified electrician or service professional.

DANGER

Risk of electric shock. Before working with any electrical connections, make certain that the Main Power breaker from the house breaker box has been turned off.

WARNING

All electrical work must be performed by a qualified electrician and must conform to all local codes.

IMPORTANT

Due to the danger of severe electrical shock, locate all power disconnects before servicing a spa. Precautions must be taken whenever working with breaker boxes, G.F.C.I.'s, or service disconnects.

Electrical Installation

A licensed electrician must accomplish the electrical installation in accordance with the National Electric Code(NEC) Article 680, and any local codes in effect at the time of installation.

Refer to the System Data Label for equipment voltage and maximum amperage draws.

The GFCI (Ground Fault Circuit Interrupter) is a mandatory electrical safety device required for all portable spas and hot tubs as specified in the National Electrical Code Article 680-42. The GFCI in your particular installation may be installed at the electrical service panel or a separate sub-panel.

Use copper conductors ONLY. The ground must be sized following the National Electric Code, Table 250-122. For Power conductor size, refer to the National Electric Code Table 310-16.

A bonding lug has been provided on the control box to allow connection to local ground points. To reduce the risk of electrical shock, a solid copper bonding wire should be connected from this lug to any metal objects within 5 feet of the spa.

The NEC and most local codes require that a “disconnect” be installed within “line-of-site” of the spa.

Circuit & Breaker Rating	15A	20A	30A	40A	50A	60A
Maximum Amps	12A	16A	24A	32A	40A	48A
Minimum Wire Size	14	12	10	8	6	4

The above table is a wiring chart representation.

IMPORTANT- If your electrician is not absolutely sure how to connect your system correctly, call your local dealer. Any mistake may be costly and void your equipment warranty.

Electrical Installation

OPTION 1

GFCI Installed in Main Service Panel

MAIN BREAKER PANEL

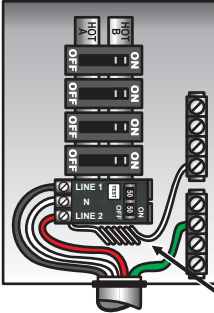

INLINE SPA DISCONNECT

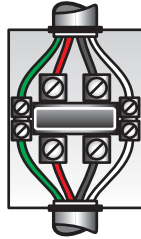

PORTABLE SPA

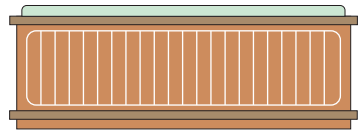

Option 1 shows the power from GFCI breaker installed into main service panel to a service disconnect within line-of-site of the spa. If the manufacturer of your homes main breaker panel makes a GFCI breaker, you may be able to add it to an open slot in the panel.

OPTION 2

Subpanel GFCI Installed

MAIN BREAKER PANEL

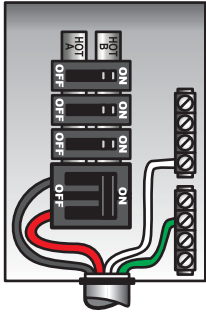

GFCI DISCONNECT

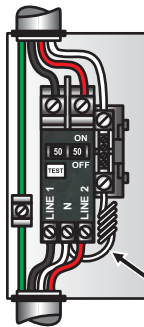

INLINE SPA DISCONNECT



TO PORTABLE SPA



Option 2 shows the power from main service panel to a GFCI subpanel within line-of-site of the spa. (Note: Most local codes will allow a GFCI subpanel to be a disconnect. If this is not the case in your installation, a disconnect must be provided.)

Electrical Installation

If your system was configured to include a 120VAC power cord, ensure that the proper receptacle has been installed (a dedicated circuit is required). DO NOT under any circumstances modify a 20 Amp plug to fit into a 15 Amp receptacle or use an extension cord. Doing so will create hazardous conditions and/or invalidate the warranty.

OPTION 3 Units with 15A / 20A GFCI Plug Connection

15/20AMP CORD END GFCI

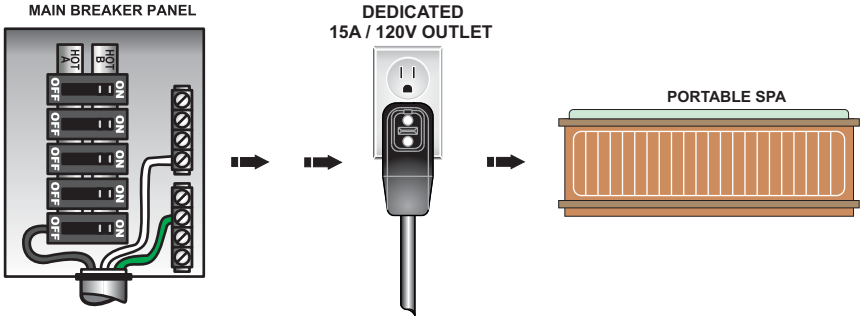

This illustration depicts a typical 15 AMP, cord-end GFCI installation. (The spa must be installed on a dedicated circuit.)

GFCI Wiring Detail

It is important that the GFCI circuit breaker is installed correctly. Often this component has been improperly installed causing the breaker to instantly trip when the system is turned on. Below is an illustration of a typical GFCI breaker installation.

WARNING: Refer to the circuit breaker manufacturers installation instructions. This illustration is meant to be a guide for Field Technicians and is not intended to override or substitute the instructions supplied with the circuit breaker.

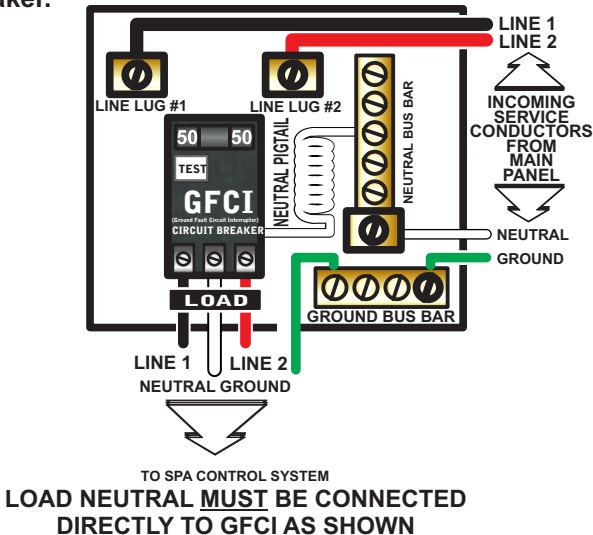

Heater Installation

The "U" Series Fixed Heater and "US" Series Slide Heater systems will arrive from the factory with the heater mounted in the bottom location as pictured in Step 1. The "US" Series Slide Heater can be installed and used in this configuration or you can move the Slide Heater to the back of the control as shown below to align easily with your particular plumbing arrangement.

Step 1

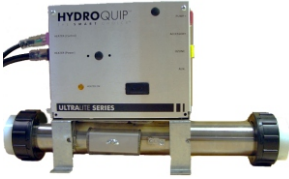

Remove the control system from the carton and verify contents for completeness. If the application is a bottom mount install then you are ready to go directly to step 5.

Step 3

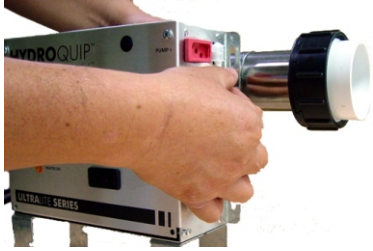

The mounting studs are attached to adjustable clamps on the heater. Loosen the clamps to adjust the stud locations to align with the slide brackets on one end. Do not tighten the nuts yet.

Step 5

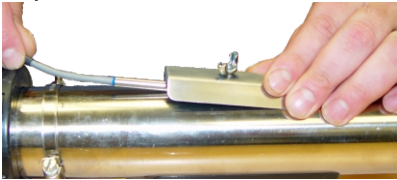

Insert the 1/4 dia. sensor probe under the sensor cover attached to the heater and tighten the wing-nut to secure.

Step 7

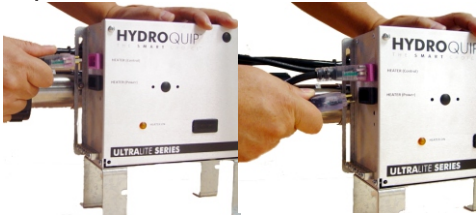

Connect the power control cords from the heater to the matching receptacles on the control box.

Step 2

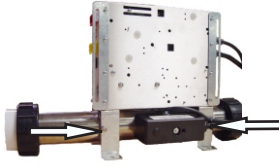

If you need to utilize the slide brackets simply remove the (2) 3/8" outer nuts securing the heater to the foot brackets and remove from under the box.

Step 4



Align the other studded clamp and attach to the other slide bracket. Now determine the proper alignment for the heater and tighten the nuts and clamps.

Step 6

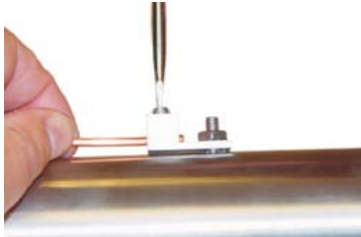

Ground/Bond the heater directly to the control box using the **included** #8 solid bonding wire.

Plumbing Considerations

The control system can be installed wherever it may be convenient, however, it is supplied with a pressure switch. Therefore, it is only possible to install the heater on the pressure side of the plumbing system. (If you find it necessary to install the heater on the suction side of the plumbing system, please contact Hydro-Quip for further information).

Temperature Sensor Installation

Option #1 Drywell: The "U" Series fixed heater configuration comes with a 10' temperature sensor to replace the existing temperature sensor for "Drywell" housings. If the existing placement of your temperature sensor does not allow for an accurate temperature reading, a drywell may have to be installed in the spa wall. Once a location has been chosen, cut a 1 1/8" hole (cut from inside the spa). Clean excess debris from around the hole. Use a water resistant silicone applied to the sealing surfaces and insert the drywell into the hole. Tighten the drywell nut (DO NOT over tighten). Insert temperature sensor into drywell and insert grommet as shown below. Allow silicone to cure for 24-hours.

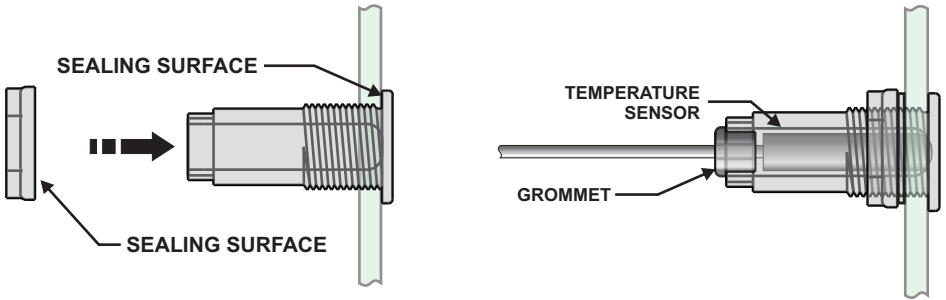

Option #2 Heater Housing: The "VS" / "US" Series heaters comes with 1/4" sensors located under the plate. To install the sensor, loosen the wing nut and slide the sensor under the plate until it becomes no longer visible. Once the sensor is install under the plate, tighten the wing nut to ensure the sensor is secure. If you wish, you can order the 10' x 3/8" temperature sensor to replace the existing temperature sensor for "Drywell" applications.

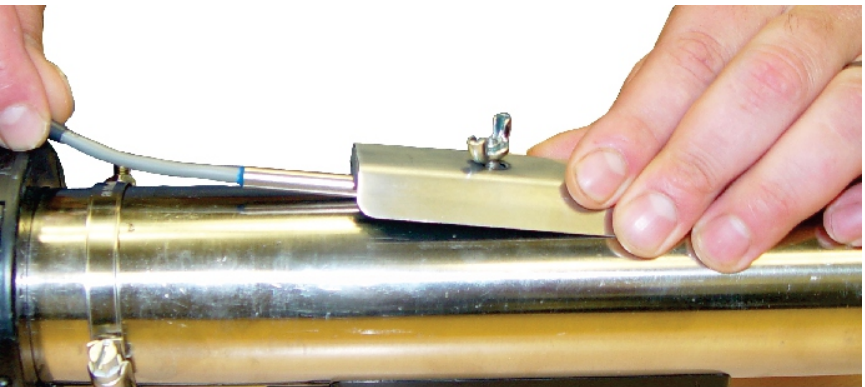

Option #3 Using your existing sensors: If you are replacing an existing Balboa Lite Leader system, you may use your existing sensors. This will be optional in applications with the temperature sensor installed in a "Wetwell" application or unable to gain access to the temperature sensor. Please refer to page 13 for sensor connection.

Optional Heaters

The Remote Heaters are supplied with a 60" cord which allows for versatile installations and locations with multiple angles. BE SURE HEATER IS INSTALLED ON PRESSURE SIDE OF PUMP.
HEATER MUST BE BONDED TO THE CONTROL BOX USING A #8 SOLID COPPER BONDING WIRE (NOT INCLUDED).



Optional Cords

Cord Adapters are available which allow you to quickly replace a control system without changing the original cords. These cord adapters allow you to take a 4-pin amp style plug from the component and quickly convert it to the molded lit mini plug for the control system, saving you hours of install time.

30-1220-L6



30-1180-L6



Power Connection

Use the illustrations and instructions below to connect your input power wiring. Always refer to the wiring diagram provided with your control (located inside the hinged cover) prior to connecting any wires.

120-Volt

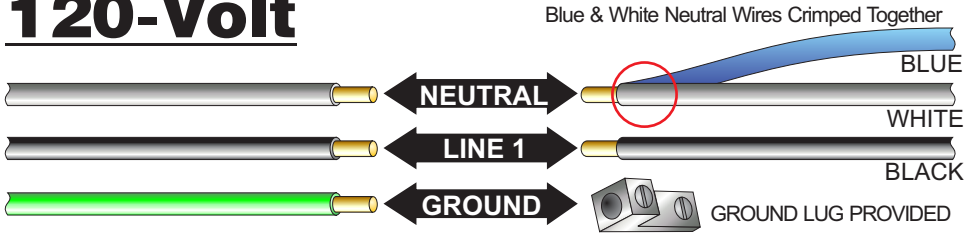

- Connect input Neutral to White Wire (crimped together with Blue wire).
- Connect Line 1 to Black Wire.
- Connect Ground to Ground Lug provided inside control box.

240-Volt

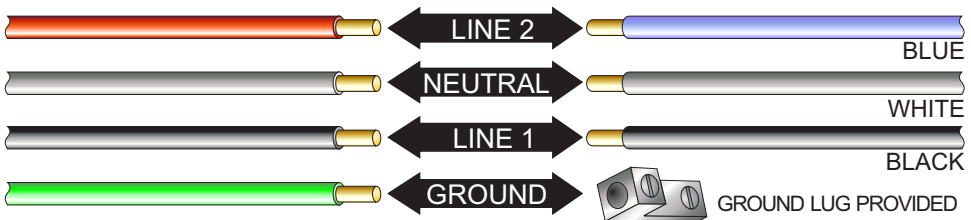

- Connect Line 2 to Blue Wire.
- Connect input Neutral to White Wire
- Connect Line 1 to Black Wire.
- Connect Ground to Ground Lug provided inside control box.

Cord Connections

2-SPEED PUMP CORD CONFIGURATION

The following wiring configuration is for two-speed pump circuits.

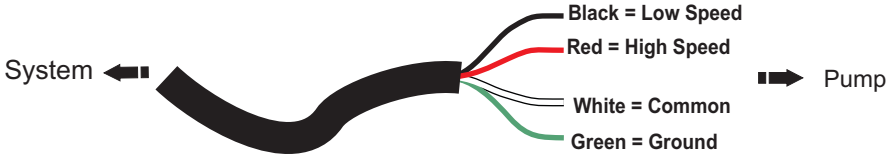

OZONE CORD CONFIGURATION

The following wiring configuration is for a ozone .



System Plug Pinouts

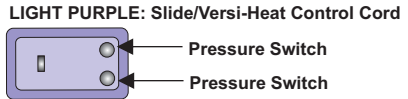
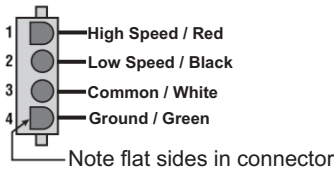
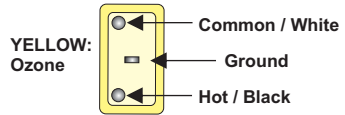
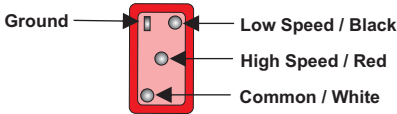

Spa Light

Your control may contain a high intensity, low voltage light to enhance night time use. This illustration shows how and where to find the bulb for replacement. It also shows the mounted spa light with a replacement (colored) lens. Colored lenses will further the enhancement of the light. Simply snap on or off to change the mood of your spa. Wall fitting, reflector and lenses are not included. Spa light circuit is LED compatible.

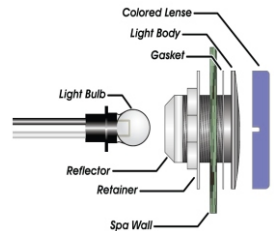

Equipment Connections

Voltage Conversions - All equipment circuits in this control system are convertible from 120v to 240v.

Pump 1 is a two-speed pump utilizing the black wire for low speed and the red wire for high speed. Pump 1 is factory configured for 120V. To convert pump 1 to 240V, move the red coded white wire (Common) from N to L2.

The ozone utilizes the black wire for L1 voltage and the white wire for neutral in 120v operation and L2 in 240v operation. The ozone is factory configured for 120V. To convert the ozone to 240V, move the yellow coded white wire (Common) from N to L2.

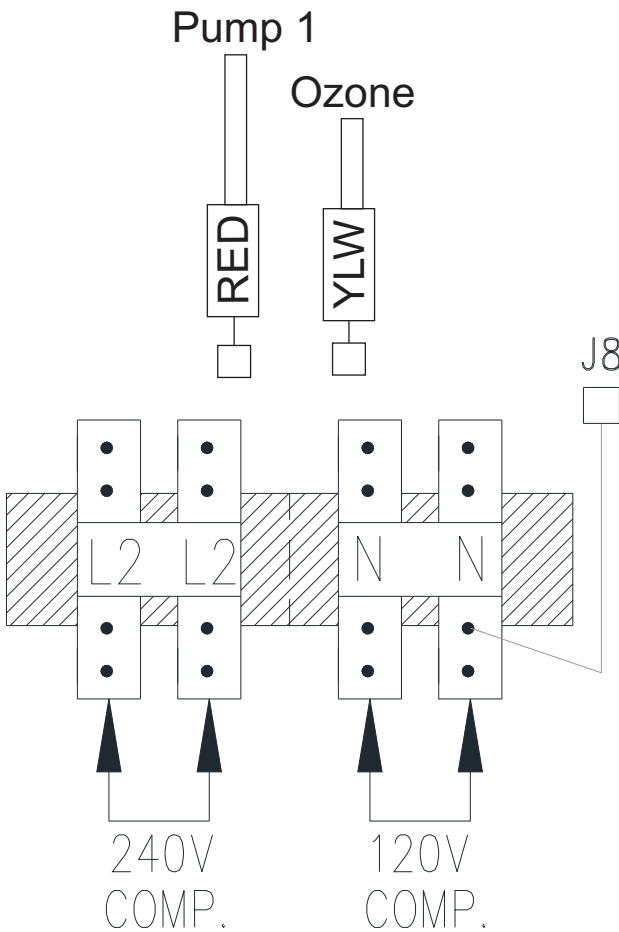

Circuit Board Configurations

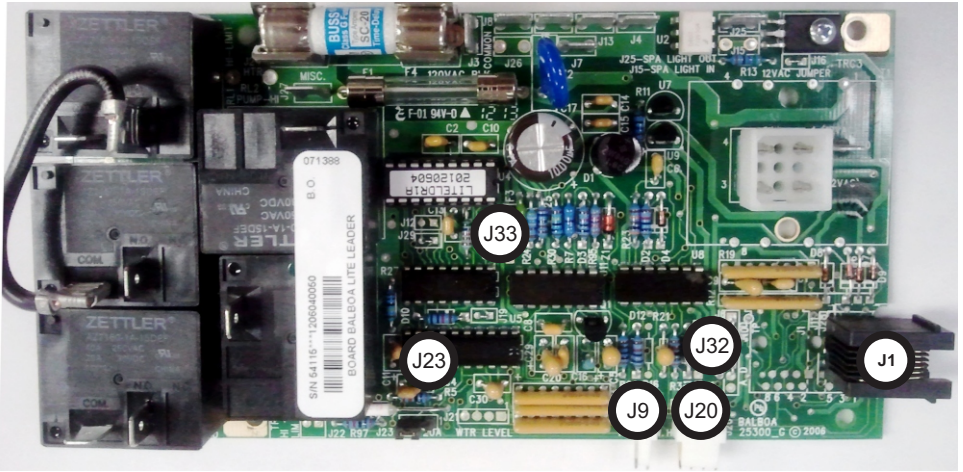

Jumper J23 - 50 amp (high amp mode) / 20 amp (low amp mode).

50 amp

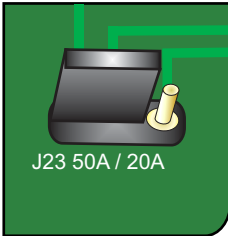

20 amp (default)

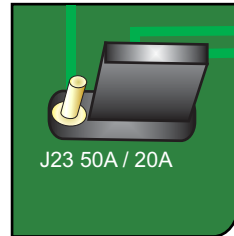

Jumper J32 - 50Hz / 60Hz selection.

1 PIN = 60HZ (default)

2 PIN = 50HZ

Jumper J33 - Filter cycle duration selection.

1 PIN = 2 Hours (default)

2 PIN = 5 Hours

Connector J1 - Spaside plug.

Connector J20 - High Limit and Temperature sensor plug. While looking at the board in the above orientation, the high limit plugs in to the left side of the connector and the temperature sensor plugs in to the right side of the connector.

Connector J9 - Pressure switch plug.

System Start-Up

- 1) Unplug the power cord (120-volt system only) or turn the electrical power “OFF” at the service or breaker panel (120 or 240 volt permanently connected units.)
- 2) Open all **WATER** shut-off valves.
- 3) For spas equipped with a hose bib or drain valve, make sure that it has been closed.
- 4) For spas equipped with in-line or pressure water filters, make sure that the filter nut, housing drain plug, and air relief valve are closed and tight.
- 5) Using a standard water hose, fill the spa with fresh tap water to the level recommended by the spa manufacturer.
- 6) Inspect all plumbing connections and lines for any sign of water leaks.
- 7) Close all **AIR** control valves. **WARNING:** Do not confuse with **WATER** shut-off valves.
- 8) Plug the unit into the proper outlet (120-volt system) or turn on the breaker at the electrical service panel (240-volt system).
- 9) Adjust temperature to the **lowest** setting.
- 10) Press the “Lights/Jets” switch to run the pump on high speed. Allow the pump to run until you achieve a strong, steady water flow (free of air bubbles).
- 11) On systems with a pressure filter, bleed off the trapped air by opening the Air-Relief valve. You will notice a steady flow of water when the air has been bled completely.
- 12) Switch the “JET PUMP” off.
- 13) If equipped, switch the light on to verify that it is working, then switch it off.
- 14) The first filter cycle will start 1 minute after power up.

Filtration Cycles

Your CS7100B will automatically filter itself twice each day. The first filter cycle will begin 1 minute after the CS7100 is powered up. The second filter cycle will begin 12 hours after the start of the first filter cycle. The filter cycle is set by default for 2 hours. During filtration, the low-speed pump and ozone generator (if installed) run continuously.

Spaside Control Operation

Displays water temperature and diagnostic messages.

LED is lit when spa is heating.

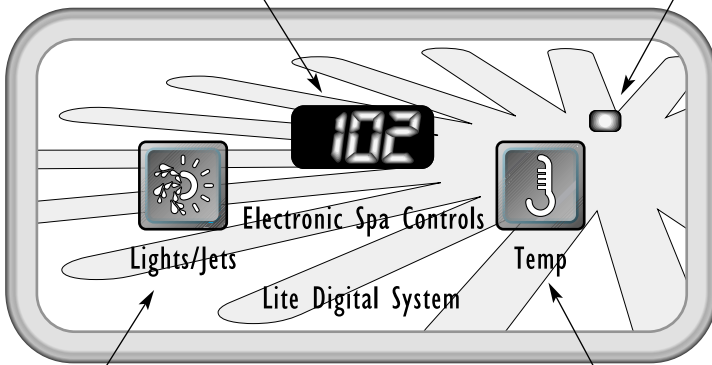

Controls the light and pump.

Controls the water temperature.



Temperature Adjustment (80°F - 104°F)

Temperature adjustment is controlled by pushing the set temperature pad. The display shows the actual water temperature unless the pad is pressed. When the pad is pressed, the display will show the set temperature. Pressing the pad a second time will cause the set temperature to increase or decrease depending on what direction was last chosen. Each successive press will change the set temperature in the same direction. If the opposite direction is desired, release the pad and let the display revert to the actual water temperature again. Press the pad to display the set temperature, and again to make the temperature change in the desired direction.



Light and Pump Control

Press the control pad to turn on the light. Press the pad again and the low-speed pump, ozone generator (if installed), and light will operate. Press the pad a third time and the high-speed pump and light will run. Press the pad again and only the high-speed pump will be on. Press the pad a final time to turn off all functions. The light will automatically turn off after 4 hours of operation. The low-speed pump and ozone generator (if installed) turn off after 2 hours. The high-speed pump turns off after 15 minutes. When the heater is turned on the pump and ozone generator (if installed) are automatically activated. If activated, neither can be turned off with the function pad; however, the high-speed pump may be started.

Operation Considerations

The following describes situations you may encounter and situations to be aware of.

Warm Weather Conditions

Since your spa will normally be expected to maintain warm to hot water ready for use, a great deal of attention has been directed to the energy conservation detail of insulation to keep electrical cost down. Energy conservation efficiency may be achieved by extensive insulation of the spa cabinet, plumbing, spa shell and in some climates full foam insulation may have been provided. This energy conservation feature may cause an inconvenience during warmer times of the year. During warm periods of the year, the temperature within the equipment compartment can elevate to a point that the pump will automatically turn off for a short amount of time (15-30 minutes) to allow the pump to cool down before automatically restarting. This cool down feature will not harm your spa, but serves only to protect the pump from damage and as an indicator that it is too hot. To minimize this occurrence, refrain from using your Hydrotherapy Jets for prolonged periods of time during warm seasons. The jet pump chosen for your spa has been specifically sized for maximum performance and your Hydrotherapy enjoyment.

Filtration System

Please refer to your Spa Manufacturer's Owner's Manual regarding the operation, maintenance and cleaning of your filtration system.

Winterizing

When freezing weather and/or power losses are expected, contact your local spa dealer for freeze protection or winterizing recommendations for both the spa and the equipment system. Freeze related damage is not covered by the warranty.

Chemical Water Treatment

Your dealer is familiar with local water conditions and which chemicals are compatible with and designed specifically for your spa. This is the best person to advise you on proper water quality management. The one thing you can do to insure years of trouble free equipment operations is to maintain proper water chemistry.

Two basic goals of the chemical water treatment are sanitizing and balancing the water. Sanitizing simply means keeping the water free from microorganisms including algae, bacteria and viruses. The current most popular chemicals for sanitizing include chlorine, bromine and ozone.

Balancing water means establishing a balance among pH, total alkalinity and total hardness. Water that is unbalanced can corrode the spa and its support equipment or leave deposits of minerals. Properly balanced water is essential to allow the sanitizing chemical to work effectively. There are numerous chemical additives to help you in controlling pH, total hardness and alkalinity. Never use softened water when filling your spa. Softened water is extremely corrosive to the metal parts of the spa equipment and may lead to an unforeseen failure. Sometimes, despite your most diligent efforts, your water may become so far out of balance to be managed chemically. At this point it is probably better to drain and clean the spa and start over with fresh water. Equipment failure caused by improper water chemistry will not be covered under warranty. Saltwater purification systems can potentially damage your equipment. Any related failures will not be covered under warranty.

Spa Side Messages

Overheat Protection (Spa is deactivated.)

OH

DO NOT ENTER THE WATER. If the spa water has reached 112°F, the display will flash "OH" (meaning overheat). Remove the spa cover to cool the water. Overheating may occur if the filter cycle is set too long. At 110°F, the spa should reset itself. If the high-limit sensor detects 118°F at the heater, the spa will shut down. When the heater cools to 110°F, press any button to reset the spa. If the spa will not reset, then shut off power to the spa and call your dealer or service organization.

Flow Switch Detection

FL

If a pressure switch malfunctions or not adjusted properly, the display will show "FL" (meaning flow). Please see page 19 & 20 for instructions on how to adjust the pressure switch.

Open Sensor (Spa is deactivated.)

Sn

If either the high-limit or water temperature sensor malfunctions, the display will show "SN" (meaning sensor). Contact your dealer or service organization. Possible defective sensor.

Troubleshooting

The following describes situations and possible solutions to common problems you may encounter as a spa owner.

Nothing Operates

- Main Breaker is OFF - *Set to On.*
- Sub-Panel Breaker Off - *Set to On.*
- Equipment GFCI Off - *Set to On.*
- Power switch in Off position - *Set to On.*
- Components not plugged in - *Plug in components.*
- Power cord not plugged in - *Plug in power cord.*
- Over or High Temperature Protection On - *Refer to Spa Side Messages.*

No, Low or Surging Water Flow

- Air Lock in Plumbing System - *"Bleed" the system.*
- Restricted Flow - *Insure that the water shut-off valves are open and that suction fittings are not blocked by debris.*
- Dirty Filter - *Clean or replace filter.*
- Low Water Level - *Increase water level to recommended level.*

Troubleshooting Cont.

Low Speed Pump Not Operational

- Circuit board configuration is Incorrect - *Contact your local dealer.*
- Pump Not Plugged-In - *Plug in the Pump.*
- Blown Fuse - *Contact your local dealer.*

Jets Not Operational

- Pump Not Plugged-In - *Plug in the Pump.*
- Blown Fuse - *Contact your local dealer.*
- Over or High Temperature Protection On - *Refer to Spa Side Messages.*

Therapy Jet Not Operational

- Water Shut-Off Valves are Closed - *Open Shut-Off valves.*
- Dirty Filter - *Clean or replace filter.*
- Jets Not Properly Adjusted - *Adjust Jets properly.*
- Diverter Valve Not Properly Adjusted - *Adjust diverter valve properly.*
- Thermal Overload Tripping - *Check for restricted flow of water.*

Water Leaks

- Spa Overfilled - *Adjust water level.*
- Too Many People in the Spa - *Adjust water level.*
- Drain-Valve Left Open - *Close drain valve.*
- Couplings or Unions Loose - *Tighten or contact your local dealer.*
- Pump Seal Leaking - *Contact your local dealer.*
- Plumbing / Connections Leaking - *Contact your local dealer.*
- Water Leaking from Spaside Control - *Contact your local dealer.*
- Water in Air Blower Plumbing - *Contact your local dealer.*

No Heat

- Temperature Not Set Correctly - *Adjust Set Point.*
- Over or High Temperature Protection On - *Refer to Spa Side Messages*
- Current Limiting On - *120V Systems will not heat if High Speed Pump is on. Contact your local dealer.*
- No Power - *Reset breaker at service panel.*
- Low Water Flow - *Clean or Replace filter.*
- Pressure Switch is Open - *Refer to page 19 & 20.*

Light Not Operational

- Light Bulb Defective - *Replace bulb.*
- Reflector has Fallen Off - *Replace deflector or contact your local dealer.*
- Light Not Plugged-In - *Plug in the Light.*

High Heat

- Filter Cycles Running Too Long - *Adjust filter cycles down.*
- Temperature Set Too High - *Adjust Set Point.*
- High Ambient Temperature - *Remove spa cover.*

GFCI Breaker Trips Occasionally

- Lightning / Electrical Storm or Power Surge - *Reset GFCI Breaker.*
- NOTE: The GFCI breaker must be properly installed by a licensed electrician.

GFCI Breaker Trips Immediately

- Defective Component or Improper GFCI Breaker Installation - *Contact a qualified service technician or the factory for assistance.*

Fixed Heater Pressure Switch Adjustment

The function of the pressure switch is to turn the heater off if the pump stops operating or if there is a restricted water flow (dirty filter, obstruction in the spa plumbing etc.).

The pressure switch has been preset at the factory to operate properly with your spas specific plumbing. Adjustment or other service may be required if you observe a flow related problem (FL on the spaside display). If adjustment is required, follow the next steps carefully.

IMPORTANT: After any pressure switch adjustment, it is important to test the control by turning on the pump low speed and heater. While operating, unplug the pump, the heater must turn off. If the heater stays on, plug the pump back in and readjust the pressure switch to achieve proper operation.

Adjustment

- 1) With power to system turned OFF, remove the wires from the pressure switch terminals (secure wires safely to prevent any chance of electrical shock).
- 2) Use temperature adjustment key to move “set point” temperature to its lowest setting.
- 3) Turn power to the system ON and activate the low-speed pump.
- 4) Place an Ohmmeter across the pressure switch terminals to verify an OPEN circuit.
- 5) Rotate the pressure switch adjustment screw counter-clockwise until the Ohmmeter indicates a CLOSED circuit.
- 6) Turn pump OFF and verify that the pressure switch circuit is once again OPEN.
- 7) Turn power to the system OFF and reconnect pressure switch wires. Reapply power to the system and operate the spa or hot tub as normal.

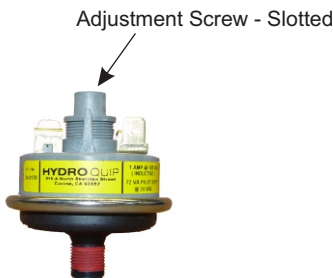

Hydro-Quip 1A Pressure Switch

HQ PT# 34-0178

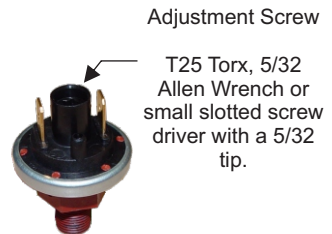

Hydro-Quip 1A Pressure Switch

HQ PT# 34-0178A

Slide/Versi-Heat Pressure Switch Adjustment

****FOR ALL TESTS & ADJUSTMENTS UNPLUG THE "HEATER POWER" CORD****

- 1) With power to system turned OFF, unplug the Lt. Purple colored Heater Control cord.
- 2) Place an Ohmmeter across the pressure switch test points on the cord to verify a OPEN circuit. If the switch is closed at this point rotate the adjustment screw clock-wise until the switch reads OPEN.
- 3) Turn power to the system ON and activate the low-speed pump.
- 4) Place an Ohmmeter across the pressure switch test points to verify a CLOSED circuit.
- 5) If switch is not closed rotate the pressure switch adjustment screw counter-clockwise until the Ohmmeter indicates a CLOSED circuit.
- 6) Re-connect the heater control cord.
- 7) Now test for proper operation of the system with the pump running and with the pump off, no error codes should be present in either instance.

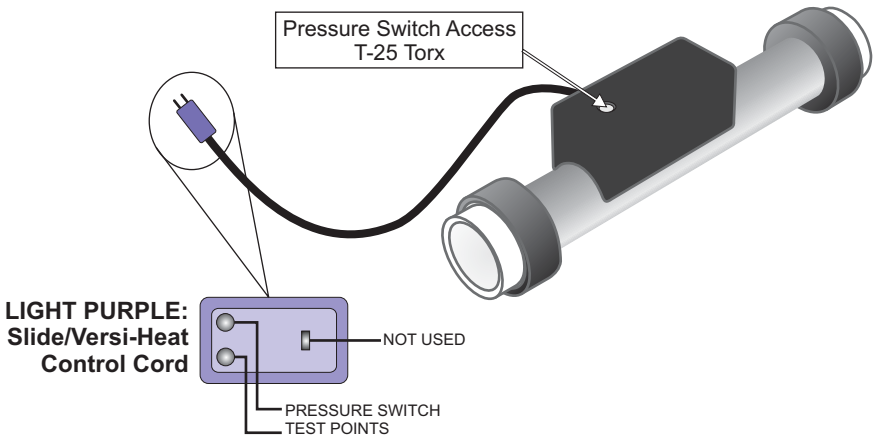

IMPORTANT: After any pressure switch adjustment, it is important to test the control by turning on the pump low speed and heater. While operating, unplug the pump, the heater must turn off. If the heater stays on, plug the pump back in and readjust the pressure switch to achieve proper operation.

System Data Label

Note: This information will be necessary if you should ever have to request warranty or any other type of service.

The system data label is located on the control box. This label is very important and contains information you will need to establish your electrical service. The voltage and amperage ratings are shown on the bottom of the label. Product, Model, Serial and Code numbers are also shown on the label. Please take a moment and fill in your information for future reference.



**REFER TO NEC FOR
BREAKER SIZING**

ORDER
CODE:
MODEL:
SERIAL:
CODE:
VOLTS:
AMPS:
PRODUCT:



Warranty Information

To all original purchasers, HydroQuip, warrants this product to be free from defects in material and workmanship for a period of 1 year from the date of manufacture.

Hydro-Quip will, at it's discretion, repair or replace any part which has been found to be defective.

This warranty excludes damage as a result of: normal wear, freezing, low voltage, chemical abuse, accident, negligence, alteration, improper installation, use or care.

To obtain warranty service, return defective products within the warranty period to Hydro-Quip.

The Hydro-Quip Limited Warranty is for service on the control box only. Purchaser is responsible for removal or reinstallation labor, freight charges, or any other such costs incurred in obtaining warranty service.

Hydro-Quip assumes no responsibility for incidental or consequential damages. Some states do not allow the exclusion of incidental or consequential damages, so the above limitations and exclusions may not apply to you. This warranty gives you specific legal rights and you may also have other rights, which vary from state to state.

If you are the end user for this control system, the spa dealer may provide a different warranty; contact your spa dealer for details and warranty information.



HYDROQUIPTM

510A N. Sheridan Street · Corona, CA 92880-2024

Email: info@hydroquip.com · Internet: <http://www.hydroquip.com/>

Telephone: 951.273.7575 · Fax: 800.332.7190