

EL1000P2 Hot Sheet

System PN 53785 (Mach 2)
Balboa Instruments

System Model # EL1-EL1000P2-DCAH

Base PCBA PN
EL1000P2 – 53786

Base Panels
ML 400 – PN 52684
ML 200 – PN 52958

EPN #1206



P/N 53785-97.pdf 03/18/2005

Circuit Board Configuration

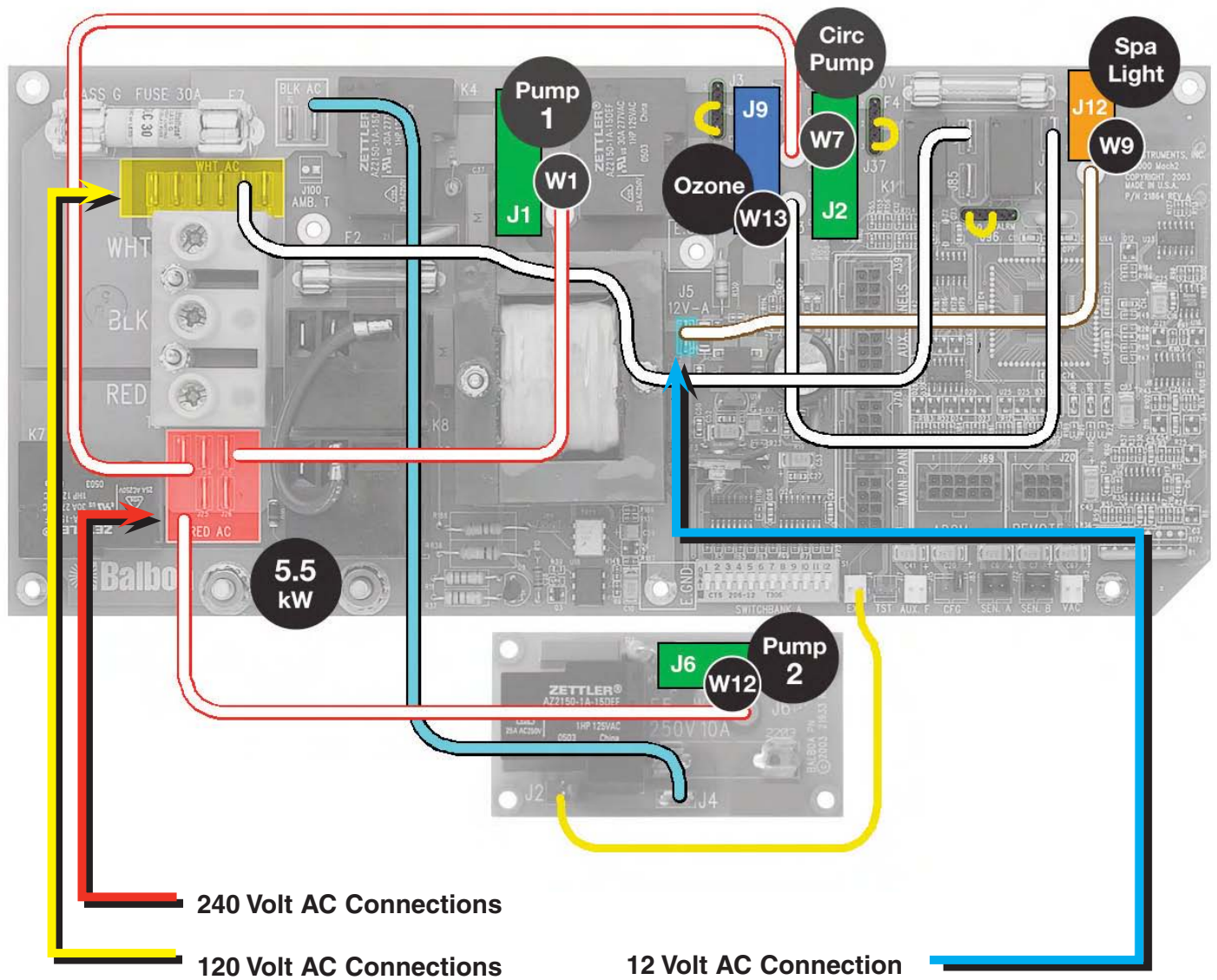

Optional Circulation Pump

To use, be sure DIP switch A9 is ON.

Circuit Board Layout

- J1 & W1 ... Pump 1
- J2 & W7 ... Circ Pump
- J9 & W13 ... Ozone
- J12 & W9 ... Light

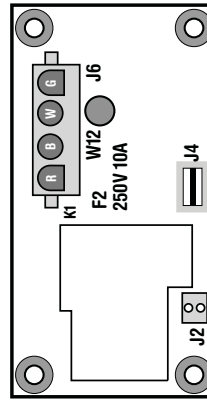
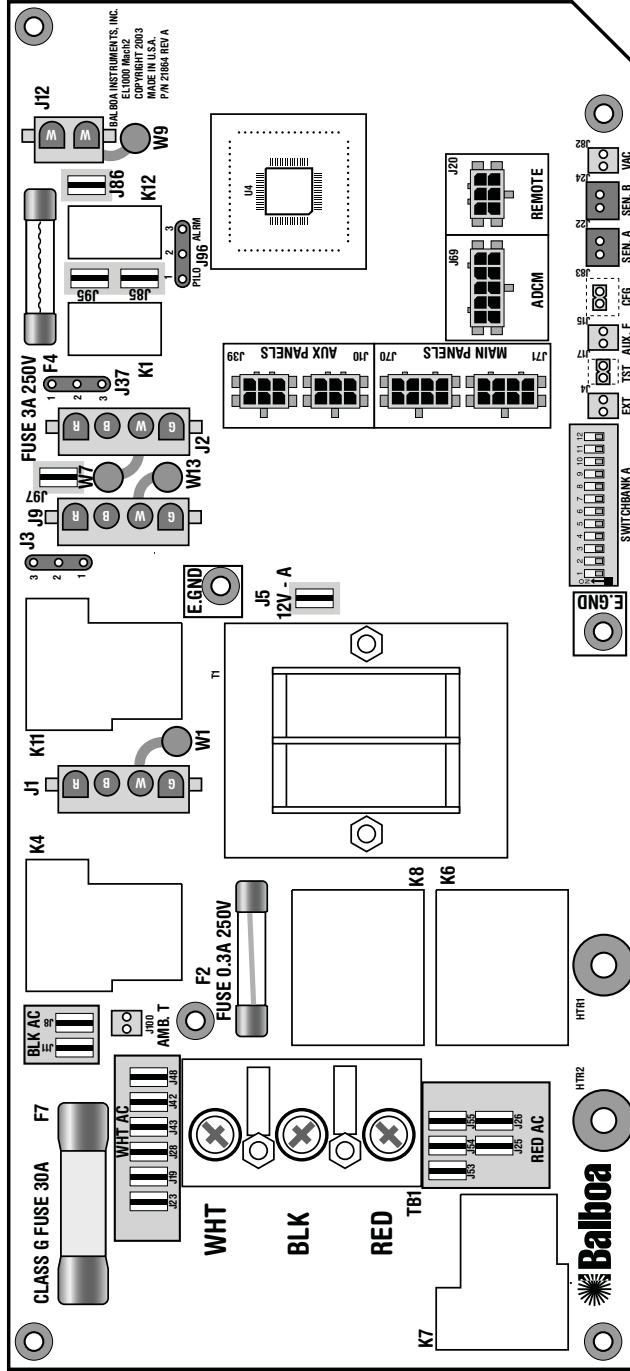

Optional Aux Relay Board (J6 & W 12)

J4 to Black AC on Main Board (J11) – Pump 2

J2 to J4 on Main Board (EXT – Near Switchbank A)

DIP Switches and Jumpers

Switchbank A

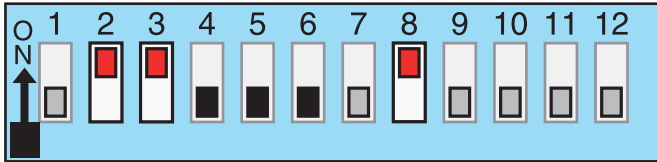

- | | |
|-------------------------------|----------------------------------|
| A1, Test Mode OFF | A7, Cleanup Cycle OFF |
| A2, High Amp | A8, Pump 2 enable |
| A3, Filter by Duration | A9, Circ Pump OFF |
| A4, 12 Hr Time | A10, Blower OFF |
| A5, Degrees F | A11, 2-speed Pump 1 |
| A6, Short Timeouts | A12, Persistent Memory ON |

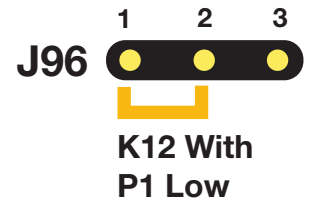
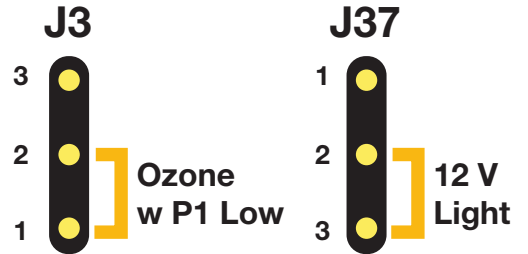

DIP Switch Key

- A 1 Test Mode (normally Off)
- A 2 In "ON" position, all high-speed pumps/blower can run with Heater
..... In "OFF" position, no high-speed pumps or blower can run with Heater
- A 3 In "ON" position, filter cycles are programmed by duration as opposed to start and end times
- A 4 Displays time in 24 hours (military time) – in ON position.
..... Displays 12 hour time when OFF
- A 5 Celsius (ON) or Fahrenheit (OFF) Temperature Display
- A 6 Pump timeout settings (15 minutes / 2 hr for P1 low (Off) or 30 minutes / 4 hr for P1 low (On))
- A 7 Cleanup Cycle – 30 min after spa use/timeout, P1-low & Ozone run for 1 hour.
- A 8 Pump 2 enable
- A 9 No Circ Pump (Off) 24 Hour Circ Pump (ON)
- A 10 Blower enable when Pump 2 is disabled (A8 Off)
- A 11 One-speed pump 1 when in Circ Mode (A9 On)
- A 12 Persistent memory reset (used when spa is powering up)

Jumper Key

- J3 Jumper on Pin 1 and 2 will power J9 (Ozone) with Pump 1 Low.
..... Jumper on Pin 2 and 3 will power J9 (Ozone) with the Circ Pump.
- J37 Jumper on Pin 1 and 2 will power one leg of J9 (Spa Light) at 120 Volts AC.
..... Jumper on Pin 2 and 3 will power one leg of J9 (Spa Light) at 12 Volts AC.
..... Note: W9 controls voltage on the other leg of J9 and must be set for the same voltage.
- J96 Jumper on Pin 1 and 2 will operate relay K12 independently.
..... Jumper on Pin 2 and 3 will operate relay K12 with Pump 1 Low.

Ozone Connections

First, configure the EL 1000 Circuit Board to deliver the desired voltage to the on-board connector (J9). Connect the W-13 wire to J86 AND the wire from J95 to either White AC (120V) or Red AC (240V) to set the voltage.

J3 should be set on pins 1 and 2 to operate the Ozone Generator with Pump 1 Low.

If you are configuring the Ozone to run 24 hours with a circ pump by setting J3 to pins 2 and 3, connect W13 directly to White AC or Red AC without the other wires.

The pin next to ground determines voltage on these connectors. Ground is typically the bottom pin of the white connector (if the flat sides of the top and bottom holes are to the left and the heater connections are on the bottom edge of the board).

The pin next to the bottom (ground) pin of J9 is fed by W-13 and sets the voltage in the connector.

If the board is set up to operate a 120V ozone generator, the connector on the ozone generator is likely to be configured correctly, but should be compared to the illustration below.

If a 240V ozone generator is required, be sure the red wire in the ozone cord is positioned in the connector next to the green ground wire as described below.

Note: A special tool is required to remove the pins from the connector body once they are snapped in place. Check with your Balboa Account Manager for information on purchasing a pin-removal tool.

Ozone connector configuration for 120V 60Hz

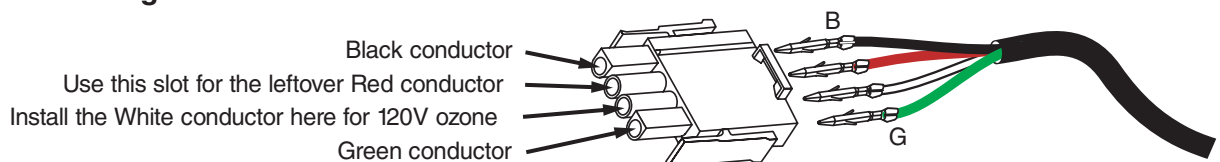

Ozone connector configuration for 240V 60Hz

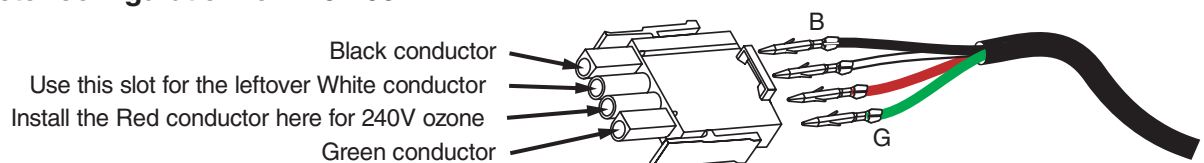

Panel Configuration

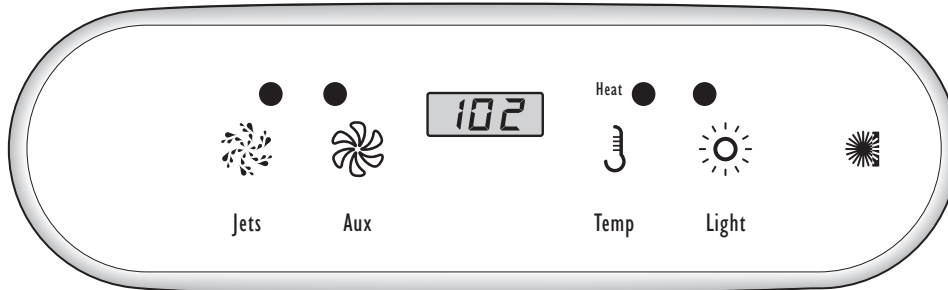

ML 400
PN 52684

OR

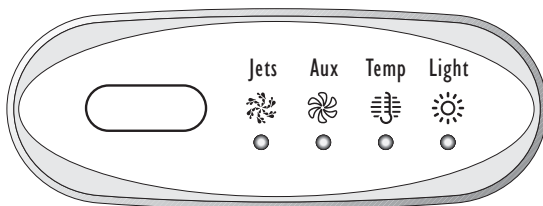

ML 200
PN 52958

Auxiliary panels are available in the following configurations:

Infrared Remote (Dolphin) which has a separate connector on the board.

4-Button (Note: Only 3 Auxiliary buttons are likely to be useful with the EL1000)

2-Button

1-Button

Configuration of the 4-Button and 2-Button Aux Panels can be done for custom applications.
1-button Aux panels are available in 4 different versions.

There are two Aux Panel connectors on the board.