

VS501 Hot Sheet

System PN 53267
Balboa Instruments

System Model # VSP-VS501-DCAH

Base PCBA PN
VS501 – 53268

Base Panels
All “Duplex” style panels



53267-97_A.PDF 11/30/2005

Circuit Board Configuration

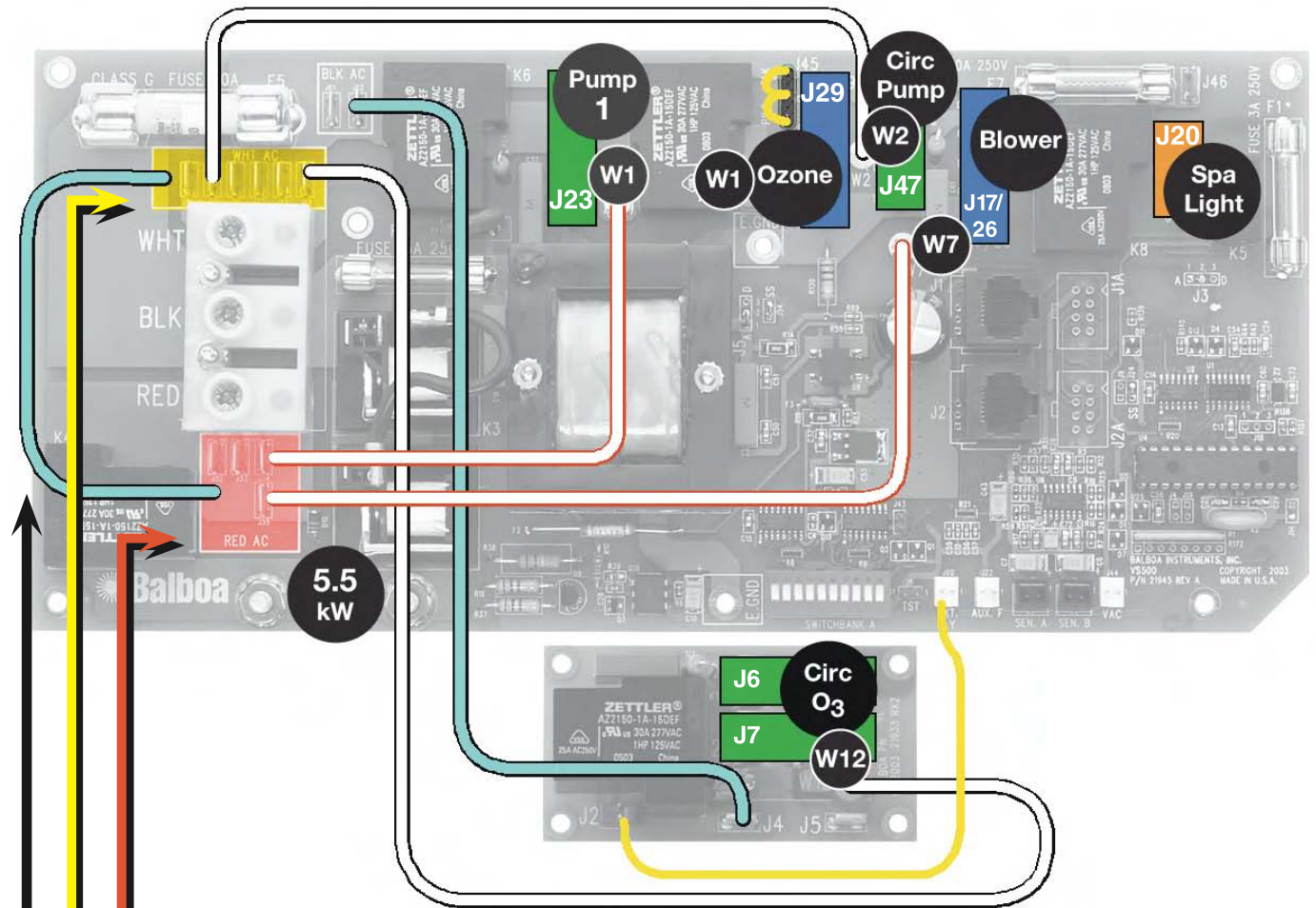

240 Volt AC Connections (RED AC when 120V heater jumper is not attached)

120 Volt AC Connections (WHITE AC)

120V Heater Jumper

Optional Auxiliary Relay Board

Use with 120V service ONLY.
(No Red, Line 2 conductor is used.)

Circ Pump and Ozone Generator MUST be the same voltage

Jumper MUST be removed when using a 240V service.

Optional Circulation Pump

To use, be sure DIP switch A9 is ON.

Circuit Board Layout

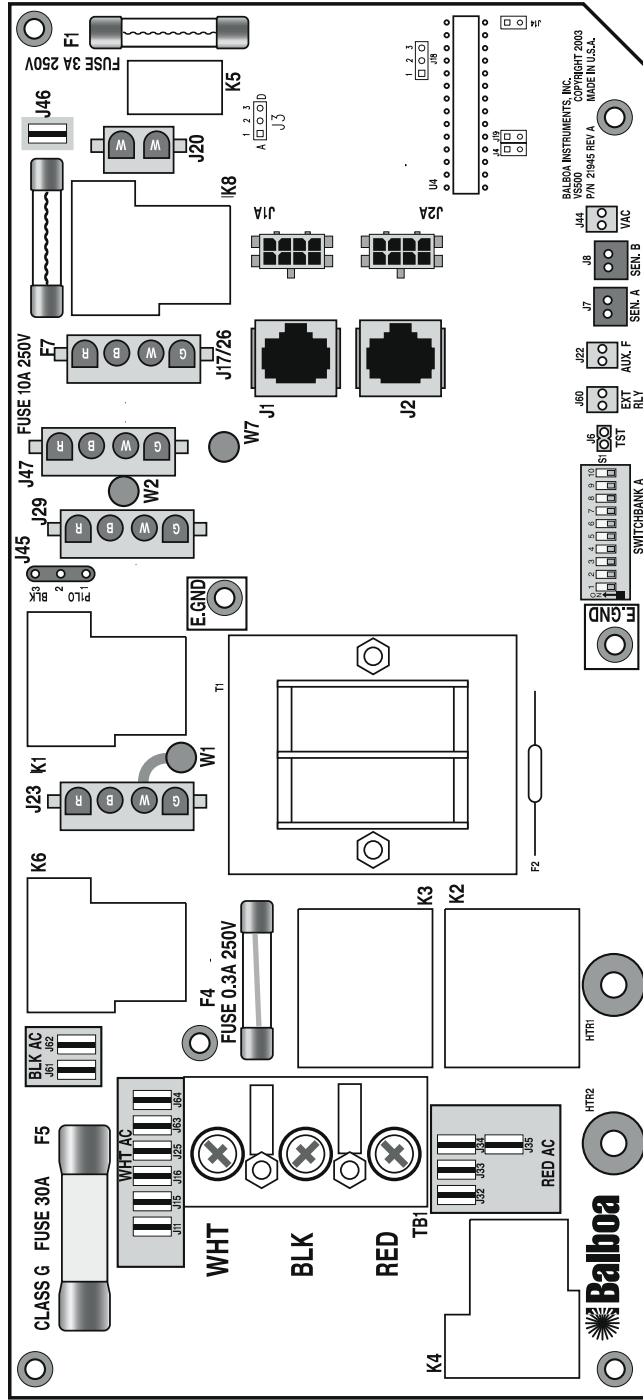

- J23 & W1 Pump 1
- J29 Ozone
Must be the same
voltage as pump 1
- J47 & W2 Circ Pump
- J17/26 & W7
..... Blower/P2
- J20 Light
12 V Only

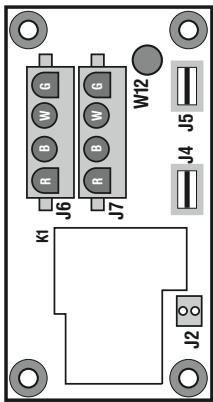

Optional Aux Relay Board 120V (J15 & W 12) 240V (J35 & W 12)
 J4 to Black AC on Main Board (J11) – Circ Pump or Ozone
 J2 to J60 on Main Board (EXT – Near Switchbank A)

DIP Switches and Jumpers

Switchbank A

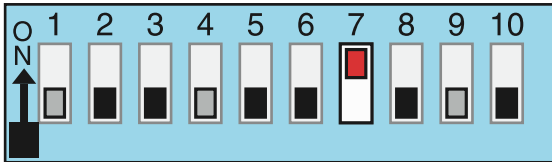

- | | |
|-----------------------|-------------------|
| A1, Test Mode OFF | A7, Blower ON |
| A2, B, J, T, L | A8, Degrees F |
| A3, Duplex Panel | A9, Circ Pump OFF |
| A4, Aux Freeze | A10, 50 Amp |
| A5, 1-speed P1 w/Circ | |
| A6, 60 Hz | |

J47



J47



Ozone MUST be the same voltage as Pump 1.

The jumper connection above does not apply if using optional relay board.

DIP Switch Key

- | | | | |
|---|----|-------|--|
| A | 1 | | Test Mode (normally Off) |
| A | 2 | | In "ON" position, Button layout will be: Jets, Light, Down, Up. (Only avail if Blower disabled)
In "OFF" position, Button layout will be: Blower, Jets, Temp, Light |
| A | 3 | | In "ON" position, use Mini Panel
In "OFF" position, use Digital Duplex or Light Duplex panel. |
| A | 4 | | Aux Freeze (must be OFF). |
| A | 5 | | In "ON" position, Two-speed pump 1 when in Circ Mode (A9 On)
In "OFF" position, One-speed pump 1 when in Circ Mode (A9 On) |
| A | 6 | | In "ON" position, 50Hz operation
In "OFF" position, 60Hz operation |
| A | 7 | | In "ON" position, Blower is enabled
In "OFF" position, Blower is disabled |
| A | 8 | | In "ON" position, temperature is displayed in degrees Celsius
In "OFF" position, temperature is displayed in degrees Fahrenheit |
| A | 9 | | In "ON" Position, 24 Hour Circ Pump
(Optional external relay board will allow 3 ^o shut off for circ pump)
In "OFF" position, no circ pump |
| A | 10 | | In "ON" Position, 30A service
In "OFF" position, 50A service |

Jumper Key

- | | | |
|-----|-------|---|
| J47 | | Jumper on Pin 1 and 2 will power J9 (Ozone) with Pump 1 Low.
Jumper on Pin 2 and 3 will power J9 (Ozone) 24 hours (for Circ mode). |
|-----|-------|---|

Ozone Connections

First, configure the VS 501 Circuit Board to deliver the desired voltage to the on-board connector (J9).

Non-Circ: The Ozone Generator and Pump 1 must be the same voltage. J3 should be set on pins 1 and 2 to operate the Ozone Generator with Pump 1 Low.

Circ: If you are configuring the Ozone to run 24 hours with a circ pump by setting J3 to pins 2 and 3, connect W13 directly to White AC or Red AC without the other wires.

The pin next to ground determines voltage on these connectors. Ground is typically the bottom pin of the white connector (if the flat sides of the top and bottom holes are to the left and the heater connections are on the bottom edge of the board).

The pin next to the bottom (ground) pin of J9 is fed by W-13 and sets the voltage in the connector.

If the board is set up to operate a 120V ozone generator, the connector on the ozone generator is likely to be configured correctly, but should be compared to the illustration below.

If a 240V ozone generator is required, be sure the red wire in the ozone cord is positioned in the connector next to the green ground wire as described below.

Note: A special tool is required to remove the pins from the connector body once they are snapped in place. Check with your Balboa Account Manager for information on purchasing a pin-removal tool.

Ozone connector configuration for 120V 60Hz

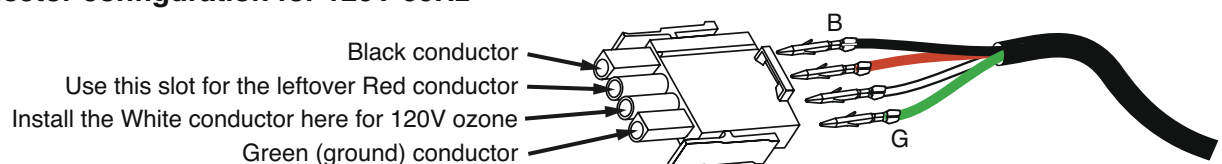

Ozone connector configuration for 240V 60Hz

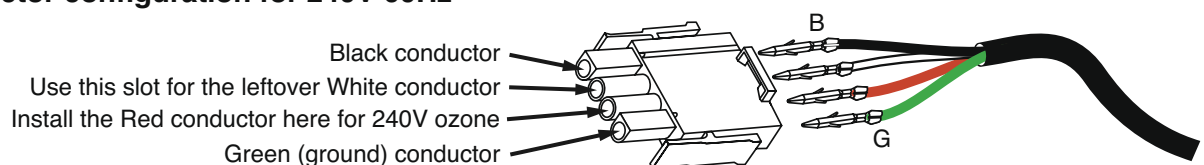

Panel Configurations

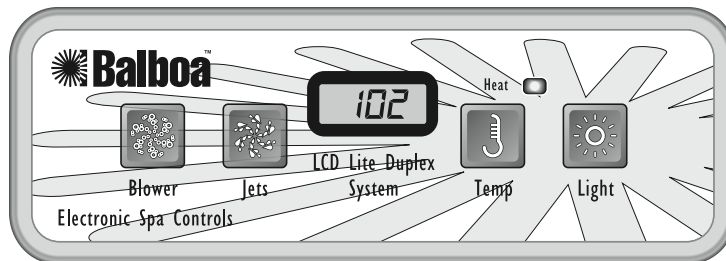
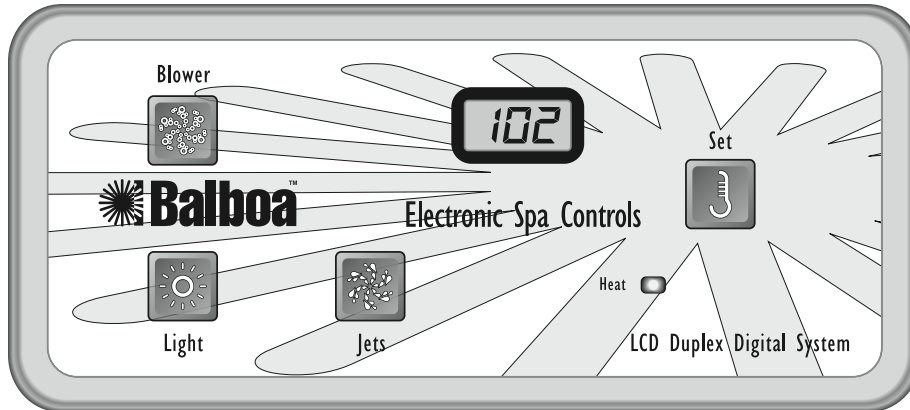

DIP switch A3 in the "OFF" position

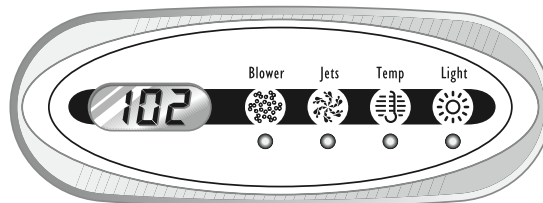

DIP switch A3 in the "ON" position

Several configurations of the panels above can be created as custom parts. Separate Temperature Up and Down buttons can be done if no Blower is present.

There are two Master Panel connectors on the board.