

LORD QUICK START GUIDE

3DM[®]-CV5-15 Vertical Reference Unit (VRU)

The 3DM-CV5-15 is an industrial-grade, board-level Inertial Measurement and Vertical Reference Unit (IMU/VRU) that utilizes micro inertial sensors for use in a wide range of industrial-grade applications, such as platform stabilization and vehicle health monitoring.

The 3DM-CV5-15 combines the strengths of an integrated multi-axis gyroscope and accelerometer, in combination with temperature readings to provide highly accurate inertial measurements.

The 3DM-CV5-15 communicates through a serial connection and is monitored by a host computer. Sensor measurements and computed outputs can be viewed and recorded with the LORD Sensing MIP Monitor software that is available as a free download from the LORD Sensing website. Alternatively, users can write custom software with the open source data communication protocol. The data is time-aligned and available by either polling or continuous stream.



The 3DM-CV5-15 Inertial Sensor can be purchased by itself or as part of a Development Kit.

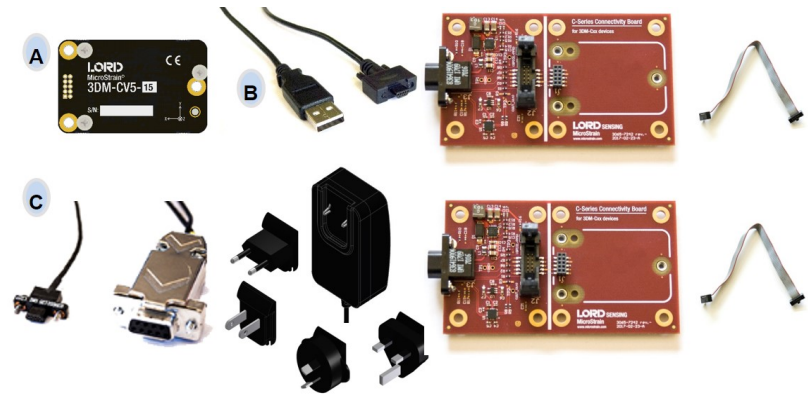

Item	Description	Quantity
Included with Sensor Purchase		
A	3DM-CV5-15 Inertial Sensor	1
	Calibration Certificate	1
USB Development Kit		
B	USB Communication Cable	1
	C-Series Connectivity Board	1
	Ribbon Cable	1
RS232 Development Kit		
C	RS232 Communication Cable, Power Supply and Plug Adapters	1
	C-Series Connectivity Board	1
	Ribbon Cable	1

The 3DM-CV5-15 sensor interface includes a communications and power input connector. The sensor is installed using the mounting and alignment holes as needed.

The indicators on the 3DM-CV5-15 include a device status indicator and the device information label. The table below describes the basic status indicator behavior. The device information label includes the sensor frame diagram (axis orientation), which will be critical during device installation.

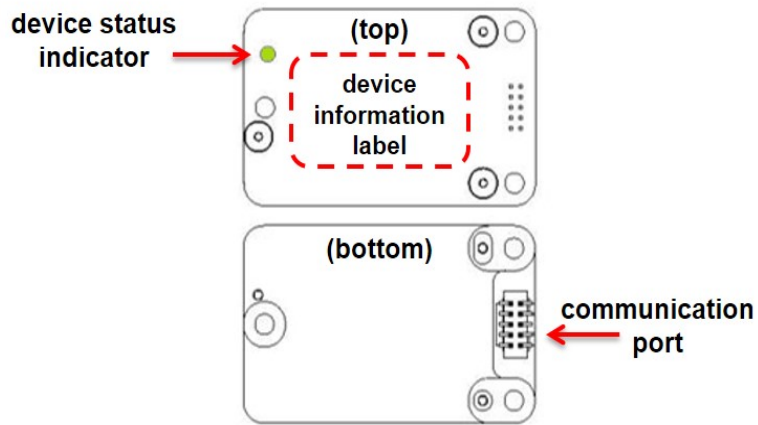

Indicator	Behavior	Device Status
device status indicator	OFF	no power applied
	rapid flash	streaming data
	slow pulse	idle mode, awaiting commands

1. Install Software

To Install the MIP Monitor software on the host computer, complete the following steps:

1. Launch the MIP Monitor software installation menu at: <https://www.microstrain.com/software>.
2. Download and open the MIP Monitor .zip file.
3. Run the **setup.exe** file, and follow the on-screen prompts to completion.
4. Download and open the Inertial Drivers zip folder to install the hardware drivers required for operating the sensor.
5. Run the .msi file, and follow the on-screen prompts to completion.
6. Run the **setup.exe** file, and follow the on-screen prompts to completion. If prompted, reboot the computer when complete.

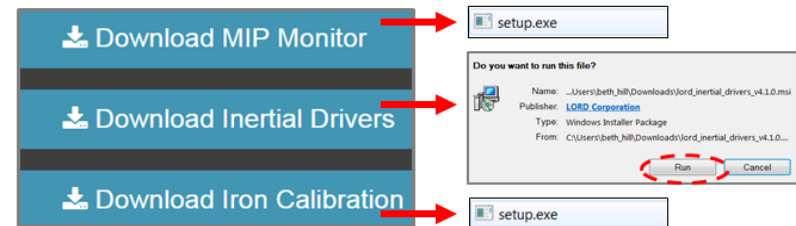

2. Make System Connections

To acquire sensor data the following components are needed: 3DM-CV5-15 sensor, communication cable, power cable (as applicable for RS232 communications), connectivity board, and a host computer with LORD Sensing MIP Monitor installed.

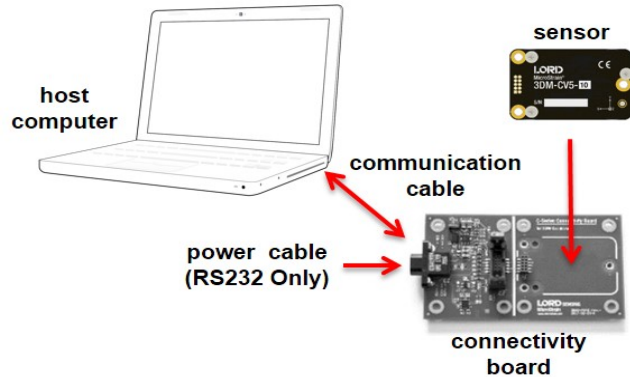

3. Software Interface

The MIP Monitor software includes a main window with system information and menus, a device settings window, and several data monitoring windows.

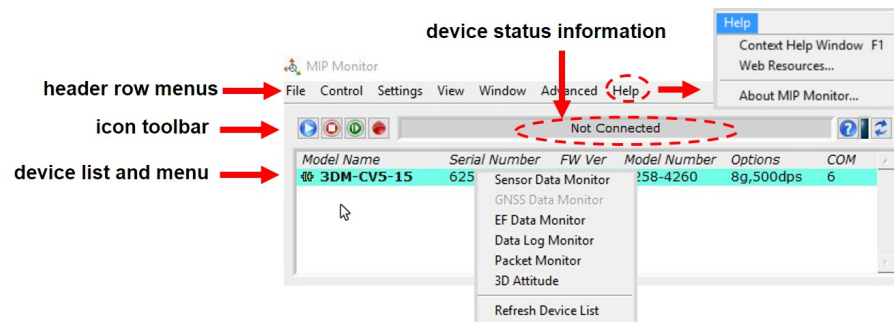

4. Establish Sensor Communication

Once power has been applied to the sensor, it is functional. If the hardware drivers have been installed, communication can be established using the MIP Monitor software interface.

1. Verify the sensor device status indicator is on.
2. Open the MIP Monitor software.
3. The sensor should appear in the device list automatically when the software is running. The list includes the device information and communication port assignment. If the sensor is not automatically discovered, use the refresh button.

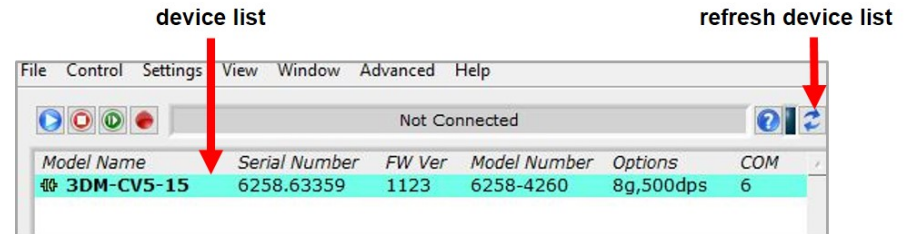

5. Select Sensor Settings

Device settings are stored in the sensor memory. Only the configuration options available for the sensor being used are displayed in the menus.

To enter the settings menu, either right-click on the sensor name highlighted in the main window, and then select Device Settings, or select Settings > Device from the main menu.

- Main menu tabs:** The main tabs divide the settings into functional groups for the available measurements. For the 3DM-CV5-15 these include
- Message Format (first sub-menu tab):** Under each main menu tab there are additional sub-menu tabs, including the Message Format tab, which allows the user to select the measurement type to be displayed and recorded (b1) and the data rate in samples/second(b2).

- c. **Measurement parameters:** Available sub-menu tabs depend on the selected main menu tab. They include the configurable settings for each measurement.
- d. **Scrolling:** used to navigate to additional sub-menus
- e. **Help button:** Enable the context-sensitive help menu for more information.

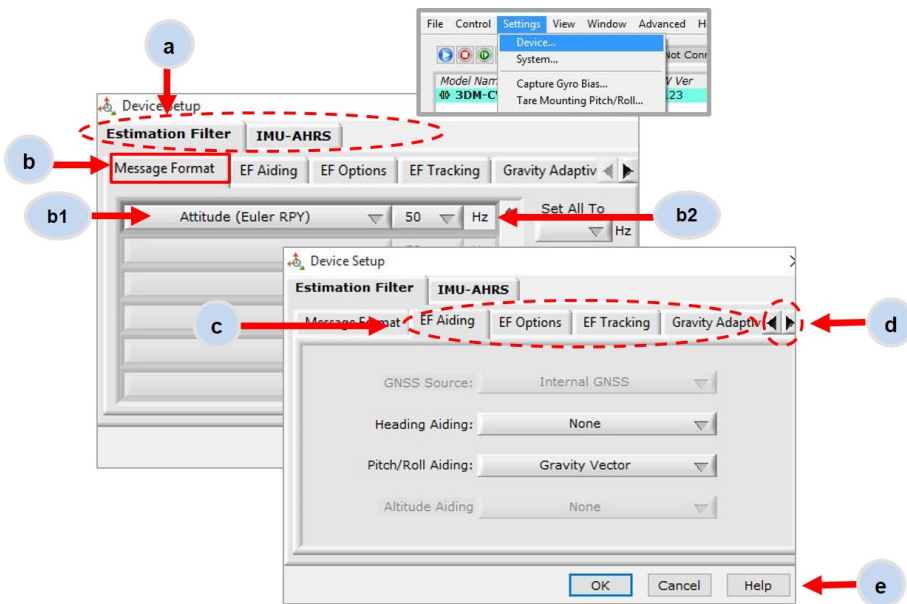

6. Save Sensor Configuration

Sensor settings are saved temporarily by selecting the OK button in the Device Setup window after configuration, but they are lost when the device is powered off. To save current settings, so they are automatically restored the next time the device is powered on, select Settings > Save Current Settings.

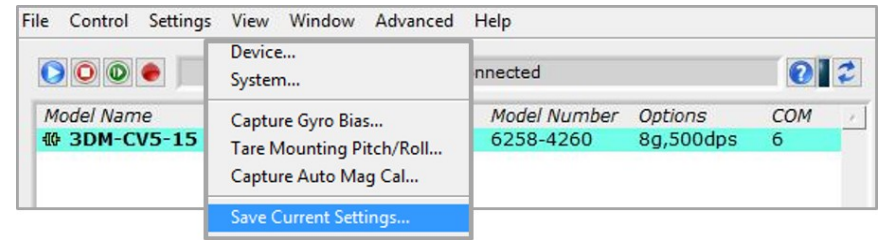

7. Start Data Streaming and Recording

Throughout the MIP Monitor views the same icons are used to control data streaming (sampling) and recording.

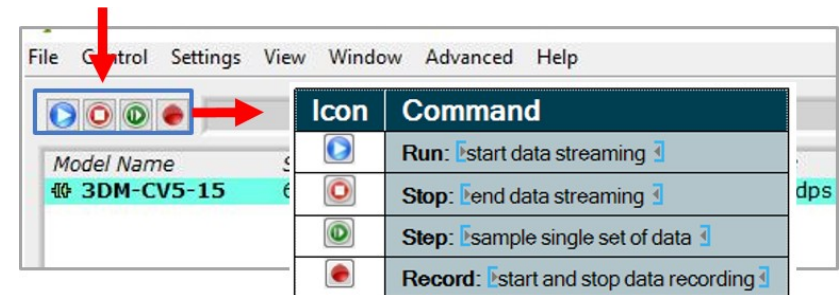

1. Right-click on the device in the MIP Monitor software main window, and select Sensor Data Monitor.
2. Click the blue Start Streaming icon to start sampling.



CSV files can be viewed with Microsoft Excel, Quattro Pro, Open Office, or other CSV editors and spreadsheet programs.

Data recorded in Binary format requires a translation program utilizing the LORD Sensing MIP Data Communications Protocol (DCP) to make it user-readable.

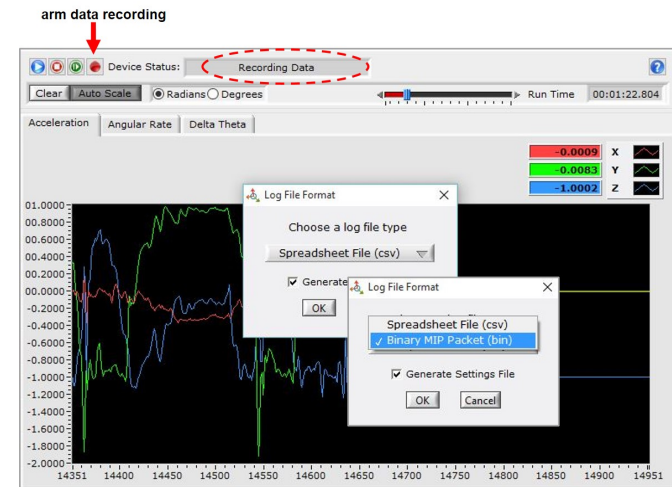

8. View Recorded Data

Recorded data is stored in either Binary (.bin) or Comma Separated Values (.csv) format, depending on what was selected at the initiation of data recording. The files can be found in the directory specified at that time or in the default directory on the host computer desktop.

9. Support

Sales Support

Products can be ordered directly from the LORD Sensing website by navigating to the product page and using the Buy feature.

<http://www.microstrain.com/inertial>

For further assistance, our sales team is available to help with product selection, ordering options, and questions.

Sales Support

sensing_sales@LORD.com

Phone: 802-862-6629

9:00 AM to 5:00 PM (Eastern Time US & Canada)

Technical Support

There are many resources for product support found on the LORD Sensing website including technical notes, FAQs, and product manuals.

http://www.microstrain.com/support_overview.aspx

For further assistance our technical support engineers are available to help with technical and applications questions.

Technical Support

sensing_support@LORD.com

Phone: 802-862-6629

SKYPE: microstrain.orientation.support

Live Chat is available from the website during business hours:
9:00 AM to 5:00 PM (Eastern Time US & Canada)