

E

D

C

B

A

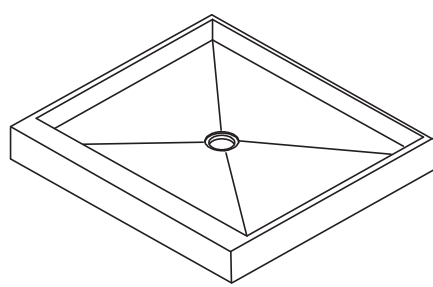
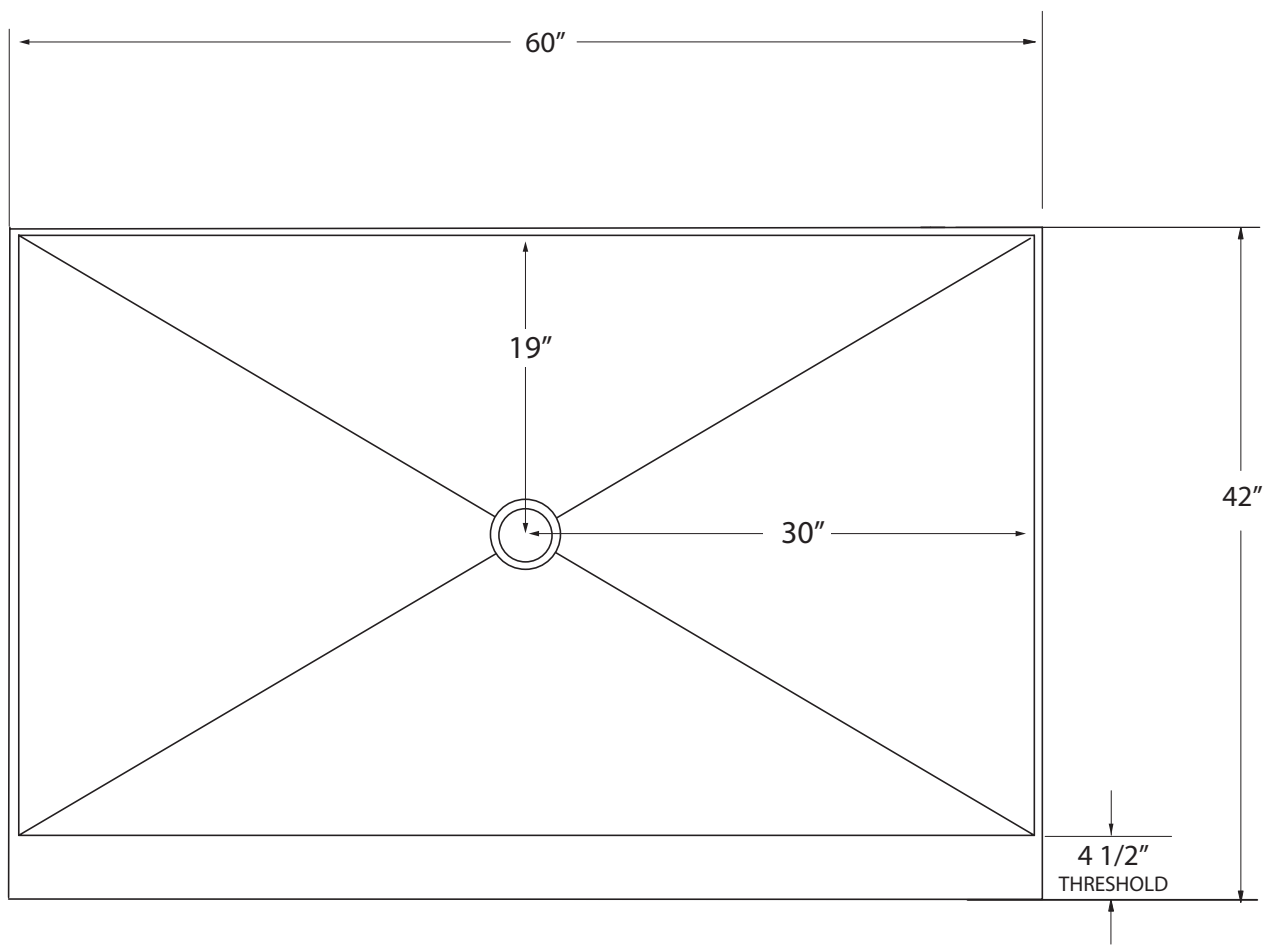

SCALE 1:25

NOTES:

DO NOT USE ANY PRODUCT SPECIFICATIONS TO BEGIN INSTALLATION BEFORE RECEIVING PRODUCT. THESE SPECIFICATION SHEETS ARE FOR REFERENCE ONLY. USE ACTUAL PRODUCT MEASUREMENTS ONLY. (OVERALL DIMENSION TOLERANCE IS +/- 1/4")

UNLESS OTHERWISE SPECIFIED DIMENSIONS ARE IN INCHES. TOLERANCES ARE X.X = ± 0.1 FRACTIONAL = ± 1/4" X.XX = ± 0.01 ANGULAR = ± 1/2" X.XXX = ± 0.005			 DECADES OF DEPENDABILITY		
<h2>SHOWER PAN</h2>					
	NAME	DATE	SIZE	PRT. NO.	REV
DRAWN		7/17/2014	A	S604204XX-C	D
CHECKED			SCALE: 1:10 FINISH: ALL		SHEET 1 OF 1
ENG. APPR.					

1

2

3

4

5