



SHINING 3D[®]

FOR MORE SHINING IDEAS

EINSCAN-SE/ SP V2 DESKTOP 3D SCANNER



MAXIMIZE THE SCANNING CAPABILITY ON YOUR DESKTOP

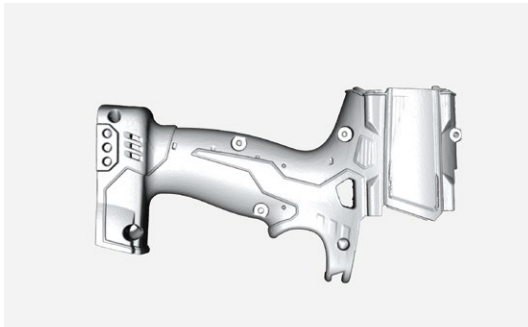

FEATURES

Extensive scanning range from small to large

Depending on the size of the object, scanning can be carried out using a turntable for automatic scanning or a tripod for manual scanning.

Easy operation, user-friendly workflow and faster scanning

One-click scanning
Automatic calibration without complex settings

Fine details

Highly detailed reproduction of display data

Colour scanning

Easy reproduction of physical 3D models with coloured textures

Compatible with 3D printers

Auto meshing to watertight 3D data for 3D printing

Safety in use

Visible white light, safe for human eyes

EinScan-SE/ SE V2

A powerful companion for educators and individuals

- Simple 3D scanning experience for non-technical users
- Wide range of scans from small to large
- Easy to operate and cost-effective

EinScan-SP/ SP V2

The expert's choice for enhanced experience

- Precise calibration in a simple way, achieving high accuracy of better than 0.05 mm
- Faster scanning speeds
- Multiple alignment modes
- Enables high-resolution 3D modelling even for professional users

Model	EinScan-SE	EinScan-SE V2	EinScan-SP	EinScan-SP V2
Scan speed of a single shot	<8s	<1s	<4s	<1s
Scan speed of one turn	<2mins	<45s	<1min	<45s
Align Mode				
Manual	√	√	√	√
Feature	√	√	√	√
Turntable	√	√	√	√
Turntable Coded Targets	x	x	√	√
Markers	x	x	√	√

APPLICATIONS



Education

K12 education, vocational school, college and university



Design & Art

High-quality 3D design, 3D printing applications, reverse engineering



Digital Industry

Animation, CG, VR&AR



Archiving and Sharing

3D digital archiving, data sharing

TECHNICAL SPECIFICATIONS

EINSCAN-SE/ SE V2

Model	Einscan-SE	Einscan-SE V2
Scan Mode	Fixed Scan with Turntable; Fixed Scan without Turntable	
Align Mode	Manually Align; Feature Align; Turntable Align	
Scan Accuracy	≤0.1 mm	
Minimum Scan Volume	30mm × 30mm × 30mm	
Maximum Scan Volume	Fixed Scan: 700mm × 700mm × 700 mm	Turntable: 200mm × 200mm × 200mm
Singe Scan Range	200 mm × 150 mm	
Scan speed of a single shot	< 8s	< 1s
Scan speed of one turn	< 2mins	< 45s
Point Distance	0.17mm ~ 0.2mm	
Color Scan	Supported	
Output Format	OBJ, STL, ASC, PLY, 3MF	
Camera Resolution	1.3MP	
Light Source	White LED	
Working Distance	290mm ~ 480mm	
Power Supply	12V, 3.33A, 40W	
Computer Requirements	OS: Win7, 8, 10 (64bit) CPU: Intel Dual Core i5 or higher; RAM: >8GB Graphics Card: Nvidia GTX660 or higher; Video Memory: >1GB USB Port: 2.0/ 3.0	OS: Win7, 8, 10 (64bit) CPU: Intel Dual Core i5 or higher; RAM: >16GB Graphics Card: Nvidia GTX660 or higher; Video Memory: >2GB USB Port: 2.0/ 3.0
Device Size	570mm × 210mm × 210mm	
Package Size	640mm × 410mm × 230mm	
Weight	4.2KG	
Certificate	CE, FCC, ROHS, WEEE	
Calibration Board	Plastic Calibration Board	
Turntable Loading Capacity	5KG	

*Notice: SHINING 3D reserves the right to explain any alteration of the specifications and pictures.

TECHNICAL SPECIFICATIONS

EINSCAN-SP/ SP V2

Model	Einscan-SP	Einscan-SP V2
Scan Mode	Fixed Scan with Turntable; Fixed Scan without Turntable	
Align Mode	Manually Align; Feature Align; Turntable Align; Markers Align; Turntable Coded Target Align	
Scan Accuracy	≤0.05mm	
Minimum Scan Volume	30mm × 30mm × 30mm	
Maximum Scan Volume	Fixed Scan: 1200mm × 1200mm × 1200mm Turntable: 200mm × 200mm × 200mm	
Singe Scan Range	200mm × 150mm	
Scan speed of a single shot	< 8s	< 1s
Scan speed of one turn	< 2mins	< 45s
Point Distance	0.17mm ~ 0.2mm	
Color Scan	Supported	
Output Format	OBJ, STL, ASC, PLY, 3MF	
Camera Resolution	1.3MP	
Light Source	White LED	
Working Distance	290mm ~ 480mm	
Power Supply	12V, 3.33A, 40W	
Computer Requirements	OS: Win7, 8, 10 (64bit) CPU: Intel Dual Core i5 or higher; RAM: > 16GB Graphics Card: Nvidia GTX660 or higher; Video Memory: >2GB USB Port: 2.0/ 3.0	
Device Size	570mm × 210mm × 210mm	
Package Size	640mm × 410mm × 230mm	
Weight	4.2KG	
Certificate	CE, FCC, ROHS, WEEE	
Calibration Board	High Accuracy Calibration Board	
Turntable	With Coded Targets	
Turntable Loading Capacity	5KG	
Attachments	Tripods; Software for Solid Edge SHINING 3D Edition	

*Notice: SHINING 3D reserves the right to explain any alteration of the specifications and pictures.
EinScan SE/ SP V2-EN 20220718-V0.2