

TOURNAD  WIMAX 

IP65

SUITABLE FOR OUTDOOR USE



 **blizzard**

Blizzard Lighting, LLC
www.blizzardlighting.com
Waukesha, WI USA
Copyright (c) 2018

TABLE OF CONTENTS

Tornado™ WiMAX 5 COB	1
1. Getting Started	3
What's In The Box?	3
Getting It Out Of The Box	3
Powering Up!	3
Getting A Hold Of Us	3
Safety Instructions (Don't run with scissors!)	4
2. Meet The Tornado™ WiMAX 5 COB	5
Main Features	5
DMX Quick Reference	5
The Tornado™ WiMAX 5 COB Pin-up Picture	6
3. Setup	7
Fuse Replacement	7
Data/DMX Cables	7
Using The Built-in W-DMX™	7
3-Pin??? 5-Pin??? Huh?	8
Take It To The Next Level: Setting up DMX Control	8
Fixture Linking (Master/Slave Mode)	9
Mounting/Rigging	9
4. Operating Adjustments	10
Navigating The Control Panel	10
Control Panel Menu Structure	11
DMX Mode	12
Set the Starting DMX Address	12
Setting the DMX Channel Mode	12
Slave Mode	12
Dimming Mode Settings	12
Custom Programs	13
Auto Mode, and Auto Speed	13
Color Calibration Settings	14
Custom Static Colors & Preset Colors	14
Fixture Reset Functions	15
Data Sync Feature	15
Fixture Information	15
DMX In-Depth Reference	17
Troubleshooting	17
5. Appendix	18
A Quick DMX Lesson	18
Keeping Your Tornado™ WiMAX 5 COB As Good As New	19
Returns (Gasp!)	19
Shipping Issues	19
Tech Specs	20
Dimensional Drawings	21

1. GETTING STARTED

What's In The Box?

- 1 x Tournado™ WiMAX 5 COB LED PAR fixture
- 1 x IP Rated AC power cord
- 1 x DMX signal cable
- This lovely user manual

Getting It Out Of The Box

Congratulations! You're now the proud owner of one tough, slightly pumpkin shaped PAR fixture! And now that you've got your TOURnado™ (or hopefully, TOURnados!), you should carefully unpack the box and check the contents to ensure that all parts are present and in good condition. If anything looks as if it has been damaged in transit, notify the shipper immediately and keep the packing material for inspection. Again, please save the carton and all packing materials. If a fixture must be returned to the factory, it is important that the fixture be returned in the original factory box and packing.

Powering Up!

All fixtures must be powered directly off a switched circuit and **cannot be run off a rheostat (variable resistor) or dimmer circuit, even if the rheostat or dimmer channel is used solely for a 0% to 100% switch.**

AC Voltage Switch - Not all fixtures have a voltage select switch, so please verify that the fixture you receive is suitable for your local power supply. See the label on the fixture or refer to the fixture's specifications chart for more information. A fixture's listed current rating is its average current draw under normal conditions. Check the fixture or device carefully to make sure that if a voltage selection switch exists that it is set to the correct line voltage you will use.

Warning! Verify that the voltage select switch on your unit matches the line voltage applied. Damage to your fixture may result if the line voltage applied does not match the voltage indicated on the voltage selector switch. All fixtures must be connected to circuits with a suitable Ground (Earthing).

Getting A Hold Of Us

If something happens goes wrong, please visit www.blizzardlighting.com/support and open a support ticket. We'll be happy to help, honest.

Disclaimer: The information and specifications contained in this document are subject to change without notice. Blizzard Lighting™ assumes no responsibility or liability for any errors or omissions that may appear in this user manual. Blizzard Lighting™ reserves the right to update the existing document or to create a new document to correct any errors or omissions at any time. You can download the latest version of this document from www.blizzardlighting.com.

Author:	Date:	Last Edited:	Date:
J. Thomas	6/28/2018	J. Thomas	7/9/2018

SAFETY INSTRUCTIONS



Please read these instructions carefully. They include important information about the installation, usage and maintenance of this product.

- Please keep this User Guide for future use. If you sell the unit to someone else, be sure that they also receive this User Guide.
- ALWAYS make sure that you are connecting to the proper voltage, and that the line voltage you are connecting to is not higher than that stated on the decal or rear panel of the fixture.
- Make sure there are no flammable materials close to the unit while operating.
- The unit must be installed in a location with adequate ventilation, at least 20in (50cm) from adjacent surfaces. Be sure that no ventilation slots are blocked.
- ALWAYS disconnect from the power source before servicing or replacing fuse and be sure to replace with same fuse size and type.
- ALWAYS secure fixture using a safety chain. NEVER carry the fixture by its head. Use its carrying handles.
- DO NOT operate at ambient temperatures higher than 104°F (40°C).
- In the event of a serious operating problem, stop using the unit immediately. NEVER try to repair the unit by yourself. Repairs carried out by unskilled people can lead to damage or malfunction. Please contact the nearest authorized technical assistance center. Always use the same type spare parts.
- NEVER connect the device to a dimmer pack.
- Make sure the power cord is never crimped or damaged.
- Never disconnect the power cord by pulling or tugging on the cord.
- Avoid direct eye exposure to the light source while it is on.

Caution! There are no user serviceable parts inside the unit. Do not open the housing or attempt any repairs yourself. In the unlikely event your unit may require service, please open a support ticket at www.blizzardlighting.com/support.

2. MEET THE TOURNADO™ WIMAX 5 COB

MAIN FEATURES

- Color mixing via 7x 25W RGBAW 5-in-1 LEDs
- IP65 rated outdoor LED fixture
- OLED control menu with 4x touch sensitive buttons
- 60-degree beam angle
- Built-in wireless W-DMX™ receiver
- Built-in color & chase macros via DMX
- Built-in automated programs via master/slave
- Color mixing ability in standalone mode
- 5/7/11-channel DMX profiles w/32-bit dimming
- Convection cooled cast aluminum housing
- Dual mounting brackets for positioning flexibility
- Flicker-free constant-current LED driver
- IP rated locking power and 3-pin DMX connections

DMX Quick Reference (5-Channel Mode)

Channel	What is does...
1	Red Intensity (0 <--> 100%)
2	Green Intensity (0 <--> 100%)
3	Blue Intensity (0 <--> 100%)
4	Amber Intensity (0 <--> 100%)
5	White Intensity (0 <--> 100%)

DMX Quick Reference (7-Channel Mode)

Channel	What is does...
1	Master Dimmer (0 <--> 100%)
2	Red Intensity (0 <--> 100%)
3	Green Intensity (0 <--> 100%)
4	Blue Intensity (0 <--> 100%)
5	Amber Intensity (0 <--> 100%)
6	White Intensity (0 <--> 100%)
7	Strobe (Slow <--> Fast)

DMX Quick Reference (11-Channel Mode)

Channel	What is does...
1	Master Dimmer (0 <--> 100%)
2	Red Intensity (0 <--> 100%)
3	Green Intensity (0 <--> 100%)
4	Blue Intensity (0 <--> 100%)
5	Amber Intensity (0 <--> 100%)
6	White Intensity (0 <--> 100%)
7	Strobe (Slow <--> Fast)
8	Built-In Programs
9	Auto Speed (Slow <--> Fast)
10	Virtual Color Wheel
11	32-Bit Dimming

Figure 1: The Tornado™ WiMAX 5 COB Pin-Up Picture



Figure 2: The Rear Connections

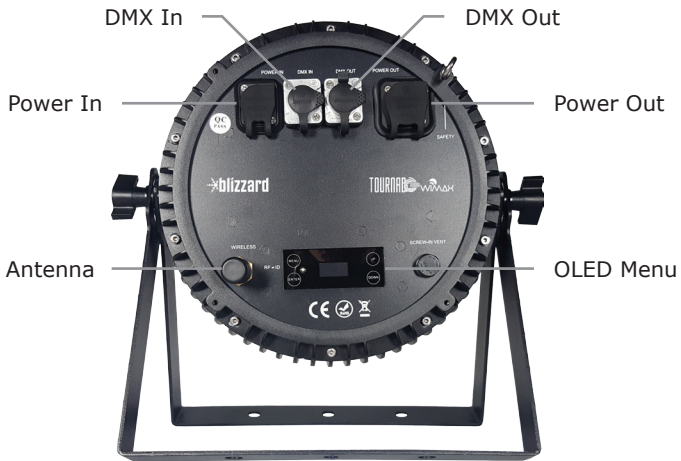

3. SETUP



Before replacing a fuse, disconnect the power cord.
ALWAYS replace with the same type and rating of fuse.

Fuse Replacement

CAUTION! The Tornado™ WiMAX 5 COB utilizes a high-output switch-mode power supply with an internal fuse. Under normal operating conditions, the fuse should not require replacement. Should your fixture require fuse replacement, please contact Blizzard Lighting for instructions.

Data/DMX Cabling

For wired connections you'll need to use data-grade DMX cables. Also, be sure to set the fixture signal input in the menu to cable: **SET > SIGN > CABL.**

Fixtures on a serial data link must be daisy chained in one single line. Also, connecting more than 32 fixtures on one serial data link without the use of a DMX optically-isolated splitter may result in deterioration of the digital DMX signal. The maximum recommended cable-run distance is 500 meters (1640 ft). The maximum recommended number of fixtures on a serial data link is 32 fixtures.

Using The Built-in W-DMX™

In addition to the unbridled thrill you already received the first time you turned it on, you'll be delighted to know that this unit is designed to work seamlessly with any W-DMX™ product. W-DMX™ is a two-time award winning wireless DMX technology, created and owned by Wireless Solution Sweden AB.

To use the built-in W-DMX™ receiver, you will first need a W-DMX™ transmitter or transceiver to broadcast the signal, such as our own LightCaster™ W-DMX™ transceiver unit. Paired up with a LightCaster™ W-DMX™ transceiver, you can expect an outstanding wireless range of up to 500 meters (line-of-sight), and leave any worries behind concerning loss of signal due to its built-in FHSS technology (Frequency Hopping Spread Spectrum).

FHSS are frequency hopping techniques, in which the transmitter jumps from one sub-channel to another at a very rapid pace. This technique was first used by the U.S. military precisely because they are difficult to disrupt, and unless you knew the frequency hopping sequence, practically impossible to intercept.

WIRELESS SOLUTION
MADE IN SWEDEN



Make sure to read the instruction manual of your LightCaster™ W-DMX™, or other W-DMX™ transmission device for other product specific setup information.

Ready to move on? Well alrighty!

Plug your wireless W-DMX transmitter into the “DMX OUT” of your controller. Please refer to your transmitting device user manual for further setup instruction.

a. One transceiver with multiple receivers:

- 1.) Power on all W-DMX receiving fixtures, and verify that the signal input in the fixture menus are set to wireless: **SET > SIGN > 2.4G**.
- 2.) On the receiving fixtures, navigate to **SET > WIRE > KEY**, and then press and hold **<ENTER>** for 3 seconds.
- 3.) Verify that your W-DMX transmitter is transmitting signal.
- 4.) The receiving fixtures should now be synced.

b. Multiple transceivers, multiple receivers; e.g. 3 groups consisting of a transceiver & receiver(s) named A, B, and C:

- 1.) Turn power off of all units.
- 2.) Group “A” gets powered on, then follow steps above.
- 3.) Group “B” gets powered on, then follow steps above.
- 4.) Group “C” gets powered on, then follow steps above.

3-Pin??? 5-Pin??? Huh?!?

If you use a controller with a 5 pin DMX output connector, you will need to use a 5 pin to 3 pin adapter. They are widely available over the internet and from specialty retailers. If you’d like to build your own, the chart below details a proper cable conversion:

Conductor	3-Pin Female (Output)	5-Pin Male (Input)
Ground/Shield	Pin 1	Pin 1
Data 1- (Primary Data Link)	Pin 2	Pin 2
Data 1+ (Primary Data Link)	Pin 3	Pin 3
Data 2- (Optional Secondary Data Link)	Pin 4	Pin 4
Data 2+ (Optional Secondary Data Link)	Pin 5	Pin 5

Take It To The Next Level: Setting Up DMX Control

Step 1: Connect the male connector of the DMX cable to the female connector (output) on the controller.

Step 2: Connect the female connector of the DMX cable to the first fixture’s male connector (input). *Note:* It doesn’t matter which fixture address is the first one connected. We recommend connecting the fixtures in terms of their proximity to the controller, rather than connecting the lowest fixture number first, and so on.

Step 3: Connect other fixtures in the chain from output to input as above. Place a DMX terminator on the output of the final fixture to ensure best communication.

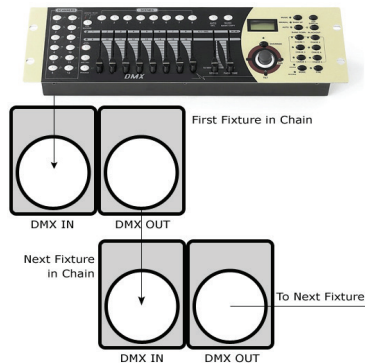

Fixture Linking (Master/Slave Mode)

1. Connect the (male) 3-pin connector side of the DMX cable to the output (female) 3-pin connector of the first fixture.
2. Connect the end of the cable coming from the first fixture which will have a (female) 3-pin connector to the input connector of the next fixture consisting of a (male) 3-pin connector. Then, proceed to connect from the output as stated above to the input of the following fixture and so on.

A quick note: Often, the setup for Master-Slave and Standalone operation requires that the first fixture in the chain be initialized for this purpose via either settings in the control panel or DIP-switches. Secondly, the fixtures that follow may also require a slave setting.

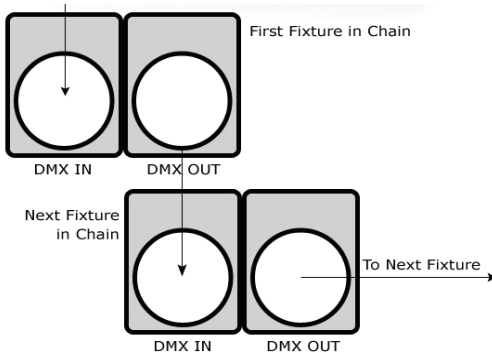

Check the **“Operating Adjustments”** section in this manual for complete instructions for this type of setup and configuration.

Mounting & Rigging

This fixture may be mounted in any SAFE position provided there is enough room for ventilation.

It is important never to obstruct the fan or vents pathway. Mount the fixture using a suitable “C” or “O” type clamp. The clamp

should be rated to hold at least 10x the fixture’s weight to ensure structural stability. Do not mount to surfaces with unknown strength, and ensure properly “rated” rigging is used when mounting fixtures overhead.

Adjust the angle of the fixture by loosening both knobs and tilting the fixture. After finding the desired position, retighten both knobs.

- When selecting installation location, take into consideration lamp replacement access (if applicable) and routine maintenance.
- Safety cables **MUST ALWAYS** be used.
- Never mount in places where the fixture will be exposed to rain, high humidity, extreme temperature changes or restricted ventilation.

4. OPERATING ADJUSTMENTS

The Control Panel

All the goodies and different modes possible with your Tornado™ WiMAX fixture are accessed by using the control panel on the rear of the fixture. There are 4 control buttons which allow you to navigate through the various control panel menus.

<MENU>

Is used to navigate to the previous higher-level menu item.

<ENTER>

Is used to select and confirm/store the current selection.

<UP>

Scrolls through menu items and numbers in ascending order.

<DOWN>

Scrolls through menu items and numbers in descending order.



The control panel display shows the menu items you select from the menu map on page #11. When a menu function is selected, the display will show immediately the first available option for the selected menu function. To select a menu item, press **<ENTER>**.

Use the **<UP>** and **<DOWN>** buttons to navigate the menu options. Press the **<ENTER>** button to select the menu function currently displayed, or to enable a menu option. To return to the previous option or menu without changing the value, press the **<MENU>** button.

Control Panel Menu Structure

ADDR	001-512	To choose the DMX address		
STAT	R	Red intensity (0% <--> 100%)		
	G	Green intensity (0% <--> 100%)		
	B	Blue intensity (0% <--> 100%)		
	A	Amber intensity (0% <--> 100%)		
	W	White intensity (0% <--> 100%)		
	SHUT	Flash / strobe speed (0-255)		
	PRSC (preset colors)	NONE, R, G, B, A, W, RGBAW, YELLOW, PINK, CYAN, ORANGE, VIOLET, GOLDEN, 2700K, 3200K, 4000K, 5500K, 6500K, RGBW		
SET	SIGN	<ENTER>	Choose the signal type: 2.4G (wireless) or CABL (cable)	
	WIRE	<ENTER>	Wireless Reset: REST, or KEY desired wireless mode (color coded LED)	
	CAL		To set global intensity levels of each color + USE: YES/NO	
	CHMD	11CH		To run in 11-channel mode
		7CH		To run in 7-channel mode
		5CH		To run in 5-channel mode
	DIM (dimming)	LIN		Linear dimming curve
		SQR		Square law curve
		ISQR		Inverse square law curve
		SCUR		S-curve
		LIN.		Linear dimming curve (smooth)
		SQR.		Square law curve (smooth)
		ISQR.		Inverse square law curve (smooth)
		SCUR.		S-curve (smooth)
	LOCK	YES/NO	To unlock, press the buttons in this order: <MENU>, <UP>, <DOWN>, <ENTER> 3x times in a row with no longer than 2 seconds between each button press.	
CTST	CT01-CT10	<ENTER>	R/G/B/A/W adjustments for custom color banks 01-10	
AUTO	AT01-AT05	<ENTER>	Auto programs 1-5	
	ATSP	<ENTER>	Auto Speed	
	CHS1	<ENTER>	Custom program 1	
	CHS2	<ENTER>	Custom program 2	
	CHS3	<ENTER>	Custom program 3	
PROG	CHS1-CHS3 Custom programs 1-3.	SC01-SC20 20 scenes for each custom program.	R (0-255)	SHUT (strobe, 0-255)
			G (0-255)	AUTO (None, AT01-AT05)
			B (0-255)	ATSP (speed, 0-255)
			A (0-255)	TIME (duration, 0-255)
			W (0-255)	WAIT (before fade, 0-255)
				USE (use scene, YES/NO)
INFO	SOFT	Vx.x	Software version information	
		POW	Current automated overheat protection level (100%/80%/50%)	
LOAD	ST L		Restore factory settings	
	PR L		Restore factory program settings	
SEND	YES/NO		Sync settings between fixtures via DMX	

DMX Mode

Allows the unit to be controlled by any universal DMX controller.

Setting the DMX Address:

1.) The default mode for the fixture is DMX, which appears as **001** on the LED readout. To select a different DMX address, using the **<MENU>** button, select **ADDR**, then hit **<ENTER>**. Use the **<UP/DOWN>** buttons to select the correct address, then hit **<ENTER>** to confirm.

Setting the DMX Channel Mode:

1.) To select a DMX channel mode, press the **<MENU>** button, then use the **<UP/DOWN>** buttons until the display reads **SET** and press the **<ENTER>** button. Then use the **<UP/DOWN>** buttons until the display reaches **CHMD**, and press **<ENTER>**. Now press the **<UP/DOWN>** buttons again to highlight your desired DMX channel mode, and press the **<ENTER>** button to confirm.

Slave Mode:

1.) Daisy chain the fixtures DMX in/out, having the controller at the beginning of the line.
2.) There is nothing else to it! The first fixture in the DMX chain is the master fixture, and the following fixtures will follow the master.

Dimming Mode Settings:

Allows users to set the fixture to use 1 of 4 (x2) dimming curve settings for smoother (and slower) dimming capabilities. In the control panel menu, there are two settings for each curve that are distinguishable from one another by the trailing dot.

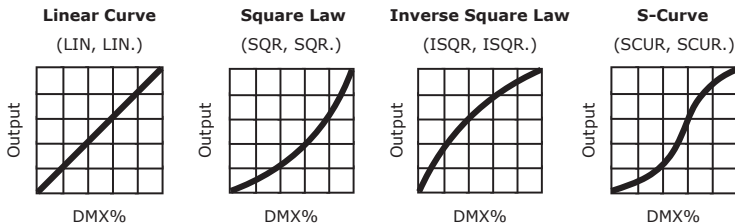

*The curve settings with the trailing dot adds a bit more delay to the curve for a smoother effect.

1.) Use the **<MENU>** and **<UP/DOWN>** buttons to navigate to **SET** and press **<ENTER>**, then **<UP/DOWN>** buttons again to scroll to **DIM**, and press the **<ENTER>** button.
2.) Now use the **<UP/DOWN>** buttons to highlight either **LIN** (Linear), **SQR** (Square), **ISQR** (Inverse Square), **SCUR** (S-Curve), **LIN.** (Smooth Linear), **SQR.** (Smooth Square), **ISQR.** (Smooth Inverse Square), or **SCUR.** (Smooth S-Curve), then hit **<ENTER>**.

Custom Programs:

Allows users to create up to 3 customizable, 20 scene programs that are directly accessible via the control panel and also in DMX mode.

Creating A Custom Program:

- 1.) Use the <MENU> and <UP/DOWN> buttons to navigate to **PROG**, and press <ENTER>.
- 2.) Now use the <UP/DOWN> buttons to highlight your choice of either **CHS1**, **CHS2**, or **CHS3** and press <ENTER>.
- 3.) Start with editing scene 1 (**SC01**), customizing it to your liking by using the choices outlined in the table below. You can insert any of its 5 built-in auto programs (**AT01-AT05**), and adjust its speed (**ATSP 0-255**), and also set the duration (in seconds) before moving on to the next scene (**TIME 0-255**). You can also add a fade in effect to the start of this scene (**WAIT 0-255**), and/or strobe (**SHUT 0-255**). Finally, if you want to use this scene in your program, *be sure to enable it (USE: YES/NO)*.
- 4.) Repeat the above process to create up to 20 scenes in each of the 3 customizable programs.

R (0-255) - Red Intensity	SHUT (0-255) - Strobe (slow - fast)	USE (YES/NO) Use Scene in Program?
G (0-255) - Green Intensity	AUTO (AT01-AT05) - Auto Programs	IMPORTANT: <i>If USE is set to NO, or TIME is set to 0, the scene will not run!</i>
B (0-255) - Blue Intensity	ATSP (0-255) - Auto Speed (fast - slow)	
A (0-255) - Amber Intensity	TIME (0-255) - Scene Time (seconds)	
W (0-255) - White Intensity	WAIT (0-255) - Fade In (fast - slow)	

Running A Custom Program:

- 1.) To view your newly created lighting masterpiece, use the <MENU> and <UP/DOWN> buttons to navigate to **AUTO**, and press <ENTER>.
- 2.) Use the <UP/DOWN> buttons to highlight your choice of **CHS1**, **CHS2**, or **CHS3** and press <ENTER>. These are directly accessible from the **built-in program channel** in DMX mode.

Auto, Modes, and Auto Speed:

Set single or Master/Slaved units to run auto modes at user selectable speeds.

Auto Mode:

- 1.) Use the <MENU> and <UP/DOWN> buttons to navigate to **AUTO**, and press the <ENTER> button.
- 2.) Now use the <UP/DOWN> buttons to highlight any program ranging from **AT01-AT05**, and press <ENTER>.

Auto Speed:

- 1.) Use the <MENU> and <UP/DOWN> buttons to navigate to **AUTO** and press <ENTER>, then with the <UP/DOWN> buttons navigate to **ATSP**, and press the <ENTER> button.
- 2.) Make a selection from **0-255**, and press <ENTER> to choose a speed (slow <--> fast).

Color Calibration Settings:

Allows the user to setup and save 1 customized R/G/B/A/W color balance setting and save it for future use. This custom setting is global, and it will effect all modes.

- 1.) Use the **<MENU>** and **<UP/DOWN>** buttons to navigate to **SET** and press **<ENTER>**, then on while **CAL**, push **<ENTER>** again.
- 2.) Use the **<UP/DOWN>** buttons to highlight either **R** (Red Level), **G** (Green Level), **B** (Blue Level), **A** (Amber Level), or **W** (White Level) then hit **<ENTER>**.
- 3.) Now using the **<UP/DOWN>** buttons, select the maximum level for each color between 000-255 (000=off), and hit **<ENTER>** to confirm your choice.
- 4.) You have now just setup and saved a custom global color calibration setting that you can use at you convenience. To use your custom setting now (or later), press the **<UP/DOWN>** buttons to reach **USE**, and press **<ENTER>**. Then choose either **YES** or **NO** and press **<ENTER>**. When you select **YES**, it enables this custom color calibration globally, and when choosing **NO** the fixture will continue to use the default color calibration settings. Your customized settings will be saved for later use even after powering off the fixture. It can be altered to your liking at any time. Just remember to return to this setting to either enable or disable it when needed.

Custom Static Colors & Preset Colors:

Allows the user to create and save custom static colors for use in standalone or DMX mode.

Static Color Mixing and Preset Mixed Colors

Important: *When finished editing and saving a static color, you must return to (and stay on) any one of the editing screens (0-255) to make the effect stay on continually. If you were only to press **<ENTER>** to save your final edit, you would again be on the static color/effect selection menu, which from here will result in blackout mode after 1 minute.*

- 1.) Use the **<MENU>** and **<UP/DOWN>** buttons to navigate to **STAT** and press **<ENTER>**, then **<UP/DOWN>** buttons to select R/G/B/A/W, and push **<ENTER>** to confirm your selection. Then in adjust the values (0-255) to your liking and press **<ENTER>** to save.
- 2.) In the same manner, you can select **SHUT** to add a strobe effect.
- 3.) You can also select **<PRSC>** and use the **<UP/DOWN>** buttons to scroll through and quickly use any of the fixtures built-in preset colors.

Mix and Save Custom Colors (1-10)

- 1.) Use the **<MENU>** and **<UP/DOWN>** buttons to navigate to **CTST** and press **<ENTER>**, then **<UP/DOWN>** buttons to select a color bank from **CT01-CT10**, and push **<ENTER>** to confirm your selection.
- 2.) Now use the **<UP/DOWN>** buttons to highlight either **R** (Red Level), **G** (Green Level), **B** (Blue Level), **A** (Amber Level), or **W** (White Level), then hit **<ENTER>**.
- 3.) Finally, using the **<UP/DOWN>** buttons, select the maximum level for each color between 000-255 (000=off), and hit **<ENTER>** to confirm your choice(s).
- 4.) These 10 custom colors can be accessed and edited to your liking at any time, and will be saved even after powering off the fixture.
- 5.) Your custom colors and programs are also directly accessible from the **built-in program channel** in DMX mode.

Fixture Reset Functions:

Allows users to reset the fixture to factory default settings, without losing customized settings, or reset the custom programs exclusively.

- 1.) Use the **<MENU>** and **<UP/DOWN>** buttons to navigate to **LOAD** and press **<ENTER>**, then use the **<UP/DOWN>** buttons to highlight **ST L** or **PR L**, and press **<ENTER>**.
- 2.) Use the **<UP/DOWN>** buttons to highlight either **YES** or **NO**, then press **<ENTER>**.
- 3.) The **ST L** reset function will reset all default values *with the exception of* those in **ADDR** (address), **CTST** (10 custom colors), and **PROG** (custom scenes and programs).
- 4.) The **PR L** reset function will only reset all customized program settings found in the **PROG** settings (custom scenes and programs).

Data Sync Feature:

Users can transfer their custom settings from one fixture to another via DMX.

- 1.) Disconnect fixtures from any DMX controllers, and link them together via DMX in/out.
- 2.) On the sending fixture (DMX out), navigate the main menu using the **<UP/DOWN>** buttons to reach **SEND**, and press the **<ENTER>** button.
- 3.) Select **YES**, and press the **<ENTER>** button to begin the transfer.
- 4.) Information for **ADDR** (address), or **CAL** (global intensity) will not be sent.
- 5.) After the data has been transferred, the receiving fixture will be automatically be reset.

Fixture Information:

These are not editable features, they are for informational purposes only.

- 1.) Use the **<MENU>** and **<UP/DOWN>** buttons to navigate to **INFO** and press **<ENTER>**, then use the **<UP/DOWN>** buttons to highlight **SOFT** or **POW**, and press **<ENTER>**.
- 2.) The **SOFT** information simply displays the current software version installed on the fixture, and **POW** displays the fixtures current power level setting. Under normal conditions, it will be at 100%... but this fixture has built-in overheat protection that may automatically reduce the output level to 80%, or 50% in high temperature situations.

DMX Values In-Depth (5/7/11-Channel Modes)

5CH	7CH	11CH	Value	What It Does
--	1	1	000 <--> 255	Dimmer (0% <--> 100%)
1	2	2	000 <--> 255	Red Intensity (0% <--> 100%)
2	3	3	000 <--> 255	Green Intensity (0% <--> 100%)
3	4	4	000 <--> 255	Blue Intensity (0% <--> 100%)
4	5	5	000 <--> 255	Amber Intensity (0% <--> 100%)
5	6	6	000 <--> 255	White Intensity (0% <--> 100%)
--	7	7	000 <--> 005 006 <--> 020 021 <--> 060 061 <--> 100 101 <--> 140 141 <--> 180 181 <--> 220 221 <--> 255	Strobe No strobe Non-synchronous strobe (slow <--> fast) Synchronous strobe (slow <--> fast) Electronic sine wave (slow <--> fast) Random strobe (slow <--> fast) Opening pulse (slow <--> fast) Closing pulse (slow <--> fast) Electronic square wave (slow <--> fast)
--	--	8	000 <--> 005 006 <--> 010 011 <--> 015 016 <--> 020 021 <--> 025 026 <--> 030 031 <--> 035 036 <--> 040 041 <--> 045 046 <--> 050 051 <--> 055 056 <--> 060 061 <--> 065 066 <--> 070 071 <--> 075 076 <--> 080 081 <--> 110 111 <--> 115 116 <--> 120 121 <--> 125 126 <--> 130 131 <--> 135 136 <--> 140 141 <--> 145 146 <--> 150 151 <--> 155 156 <--> 160 161 <--> 165 166 <--> 170 171 <--> 175 176 <--> 180 181 <--> 185 186 <--> 190 191 <--> 195 196 <--> 200 201 <--> 220 221 <--> 225 226 <--> 230 231 <--> 235 236 <--> 255	Built-In Programs No Function Custom color 1 (CT01 in menu settings) Custom color 2 (CT02 in menu settings) Custom color 3 (CT03 in menu settings) Custom color 4 (CT04 in menu settings) Custom color 5 (CT05 in menu settings) Custom color 6 (CT06 in menu settings) Custom color 7 (CT07 in menu settings) Custom color 8 (CT08 in menu settings) Custom color 9 (CT09 in menu settings) Custom color 10 (CT10 in menu settings) Auto 1 Auto 2 Auto 3 Auto 4 Auto 5 Reserved Red Green Blue Amber White RGBAW Yellow Pink Cyan Orange Violet Golden 2700K White 3200K White 4000K White 5500K White 6500K White RGBW No Function Custom program 1 (CH01 in menu settings) Custom program 2 (CH02 in menu settings) Custom program 3 (CH03 in menu settings) No Function

DMX Values In-Depth (5/7/11-Channel Modes), continued

5CH	7CH	11CH	Value	What It Does
--	--	9	000 <--> 255	Auto Speed (slow <--> fast)
--	--	10	000 <--> 010 011 012 <--> 050 051 052 <--> 090 091 092 <--> 130 131 132 <--> 170 171 172 <--> 210 211 212 <--> 250 251 <--> 255	Virtual Color Wheel No Function Blue Blue (+ green) Teal Teal (- blue) Green Green (+ red) Yellow Yellow (- green) Red Red (+ blue) Magenta Magenta (- red) Blue
--	--	11	000 <--> 010 011 <--> 020 021 <--> 030 031 <--> 040 041 <--> 050 051 <--> 060 061 <--> 070 071 <--> 080 081 <--> 090 091 <--> 255	Dimming Mode Default (as set in the LED menu) Linear curve Square law curve Inverse square law curve S-curve Linear curve (smooth) Square law curve (smooth) Inverse square law curve (smooth) S-curve (smooth) Default (as set in the LED menu)

Troubleshooting

Symptom	Solution
Fixture Auto-Shut Off	Check the fan in the fixture. If it is stopped or moving slower than normal, the unit may have shut itself off due to high heat. This is to protect the fixture from overheating. Clear the fan of obstructions, or return the unit for service.
No Light Output	Check to ensure fixture is operating under correct mode, IE auto/DMX/Etc., if applicable.
Chase Speed Too Fast/Slow	Check to ensure proper setup of speed adjustment.
No Power	Check AC cord and circuit for malfunction.
Blown Fuse	Check AC cord and circuit for damage, verify that moving parts are not restricted and that unit's ventilation is not obstructed
Fixture Not Responding / Responding Erratically	Make sure all connectors are seated properly and securely. Use Only DMX Cables and/or check cables for defects Install a Terminator. Reset fixture(s).

5. APPENDIX

A Quick Lesson On DMX

DMX (aka DMX-512) was created in 1986 by the United States Institute for Theatre Technology (USITT) as a standardized method for connecting lighting consoles to lighting dimmer modules. It was revised in 1990 and again in 2000 to allow more flexibility. The Entertainment Services and Technology Association (ESTA) has since assumed control over the DMX512 standard. It has also been approved and recognized for ANSI standard classification.

DMX covers (and is an abbreviation for) Digital MultipleXed signals. It is the most common communications standard used by lighting and related stage equipment.

DMX provides up to 512 control "channels" per data link. Each of these channels was originally intended to control lamp dimmer levels. You can think of it as 512 faders on a lighting console, connected to 512 light bulbs. Each slider's position is sent over the data link as an 8-bit number having a value between 0 and 255. The value 0 corresponds to the light bulb being completely off while 255 corresponds to the light bulb being fully on.

DMX data is transmitted at 250,000 bits per second using the RS-485 transmission standard over two wires. As with microphone cables, a grounded cable shield is used to prevent interference with other signals.

There are five pins on a DMX connector: a wire for ground (cable shield), two wires for "Primary" communication which goes from a DMX source to a DMX receiver, and two wires for a "Secondary" communication which goes from a DMX receiver back to a DMX source. Generally, the "Secondary" channel is not used so data flows only from sources to receivers. Hence, most of us are most familiar with DMX-512 as being employer over typical 3-pin "mic cables," although this does not conform to the defined standard.

DMX is connected using a daisy-chain configuration where the source connects to the input of the first device, the output of the first device connects to the input of the next device, and so on. The standard allows for up to 32 devices on a single DMX link.

Each receiving device typically has a means for setting the "starting channel number" that it will respond to. For example, if two 6-channel fixtures are used, the first fixture might be set to start at channel 1 so it would respond to DMX channels 1 through 6, and the next fixture would be set to start at channel 7 so it would respond to channels 7 through 12.

The greatest strength of the DMX communications protocol is that it is very simple and robust. It involves transmitting a reset condition (indicating the start of a new "packet"), a start code, and up to 512 bytes of data. Data packets are transmitted continuously. As soon as one packet is finished, another can begin with no delay if desired (usually another follows within 1 ms). If nothing is changing (i.e. no lamp levels change) the same data will be sent out over and over again. This is a great feature of DMX -- if for some reason the data is not interpreted the first time around, it will be re-sent shortly.

Not all 512 channels need to be output per packet, and in fact, it is very uncommon to find all 512 used. The fewer channels are used, the higher the "refresh" rate. It is possible to get DMX refreshes at around 1000 times per second if only 24 channels are being transmitted. If all 512 channels are being transmitted, the refresh rate is around 44 times per second.

In summary, since its design and evolution in the 1980's DMX has become the standard for lighting control. It is flexible, robust, and scalable, and its ability to control everything from dimmer packs to moving lights to foggers to lasers makes it an indispensable tool for any lighting designer or lighting performer.

Keeping Your Tornado™ WiMAX 5 COB As Good As New

The fixture you've received is a rugged, tough piece of pro lighting equipment, and as long as you take care of it, it will take care of you. That said, like anything, you'll need to take care of it if you want it to operate as designed. You should absolutely keep the fixture clean, especially if you are using it in an environment with a lot of dust, fog, haze, wild animals, wild teenagers or spilled drinks.

Cleaning the optics routinely with a suitable glass cleaner will greatly improve the quality of light output. Keeping the fans free of dust and debris will keep the fixture running cool and prevent damage from overheating.

In transit, keep the fixtures in cases. You wouldn't throw a prized guitar, drumset, or other piece of expensive gear into a gear trailer without a case, and similarly, you shouldn't even think about doing it with your shiny new light fixtures.

Common sense and taking care of your fixtures will be the single biggest thing you can do to keep them running at peak performance and let you worry about designing a great light show, putting on a great concert, or maximizing your client's satisfaction and "wow factor." That's what it's all about, after all!

Returns (Gasp!)

We've taken a lot of precautions to make sure you never even have to worry about sending a defective unit back, or sending a unit in for service. But, like any complex piece of equipment designed and built by humans, once in a while, something doesn't go as planned. If you find yourself with a fixture that isn't behaving like a good little fixture should, you'll need to obtain a Return Authorization (RA).

Don't worry, this is easy. Just open a support ticket at www.blizzardlighting.com/support, and we'll issue you an RA. Then, you'll need to send the unit to us using a trackable, pre-paid freight method. We suggest using USPS Priority or UPS. Make sure you carefully pack the fixture for transit, and whenever possible, use the original box & packing for shipping.

When returning your fixture for service, be sure to include the following:

- 1.) Your contact information (Name, Address, Phone Number, Email address).
- 2.) The RA# issued to you
- 3.) A brief description of the problem/symptoms.

We will, at our discretion, repair or replace the fixture. Please remember that any shipping damage which occurs in transit to us is the customer's responsibility, so pack it well!

Shipping Issues

Damage incurred in shipping is the responsibility of the shipper, and must be reported to the carrier immediately upon receipt of the items. Claims must be made within seven (7) days of receipt.

Tech Specs!

Weight & Dimensions	
Width	14 inches (35.5 cm)
Depth	6.7 inches (17.2 cm)
Height	13.3 inches (33.7 cm)
Weight	17 lbs (7.7 kg)
Power	
Operating Voltage	AC 100V-264V/47-63HZ
Power Consumption	168W, 1.44A, PF: .99
Light Source	
LED	7x 25W 5-in-1 RGBAW COB LEDs, 100,000 hours.
Optical	
Beam Angle	60-degree beam
Thermal	
Max. Operating Temp.	104 degrees F (40 degrees C) ambient
Control	
Protocol	USITT DMX-512
DMX Channels	5/7/11-channel DMX modes
Input/Output	3-pin XLR Male/Female
Other Operating Modes	DMX512, M/S, Standalone, Auto Mode
Warranty	2-year limited warranty, does not cover malfunction caused by damage to LEDs.

Photometric Data

60° Beam Angle

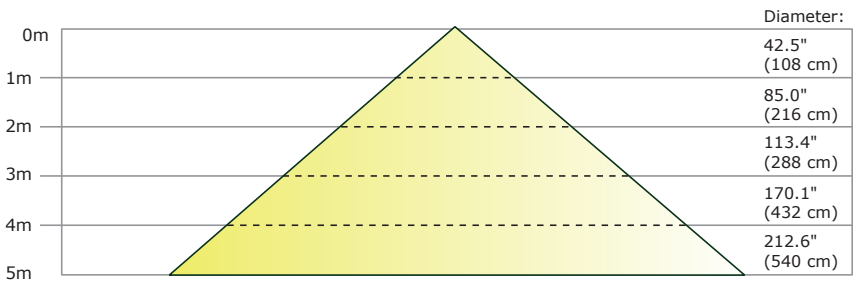

Luminous Intensity:

Beam	2-meter		3-meter		4-meter		5-meter	
	Lux	fc	Lux	fc	Lux	fc	Lux	fc
25°	2,539	235.9	1,145	106.4	665	61.8	423	39.3

Dimensional Drawings

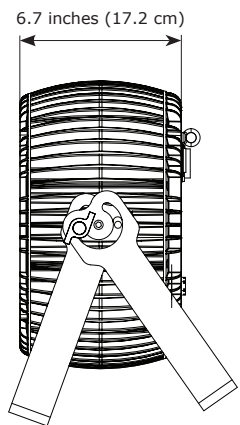
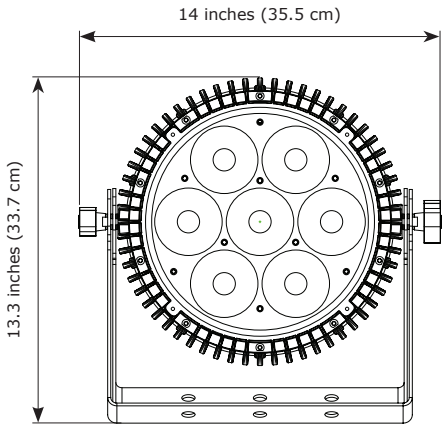

This page intentionally left blank.

This page intentionally left blank.



**Enjoy your product!
Our sincerest thanks for your purchase!
--The team @ Blizzard Lighting**