

TOURNADO

SKY W-DMX™



inteli**ion**
INTELLIGENT
LITHIUM-ION
BATTERY SYSTEM



Blizzard Lighting, LLC
www.blizzardlighting.com
Waukesha, WI USA
Copyright (c) 2016

TABLE OF CONTENTS

TOURnado Sky W-DMX™	1
1. Getting Started	4
What's In The Box?	4
Getting It Out Of The Box	4
Powering Up!	4
Getting A Hold Of Us	4
Safety Instructions (Don't run with scissors!)	5
2. Meet The TOURnado Sky W-DMX™	6
Features	6
DMX Quick Reference	6
The TOURnado Sky W-DMX™ Pin-up Picture	7
3. Setup	8
Connecting A Bunch Of TOURnado Sky W-DMX™ Fixtures	8
Data/DMX Cables	8
Using The Built-in W-DMX™	8
Using The Intelion™ Battery System	9
Cable Connectors	10
3-Pin??? 5-Pin??? Huh?	10
Take It To The Next Level: Setting up DMX Control	10
Fixture Linking (Master/Slave Mode)	11
Mounting/Rigging	11
4. Operating Adjustments	12
Navigating The Control Panel	12
Control Panel Menu Structure	13
LED Display Menu Lock	13
DMX Mode	14
Set the Starting DMX Address	14
Select the DMX Channel Mode	14
Slave Mode	14
Auto Mode	14
Standalone Mode	14
Flash/Fade Modes	14
Program Speed	14
Manual Color Adjustments	14
Dimming Mode	15
DMX Channel Values In-Depth	16
Troubleshooting	17
5. Appendix	18
A Quick DMX Lesson	18
Keeping Your TOURnado Sky W-DMX™ As Good As New	19
Returns (Gasp!)	19
Shipping Issues	19
Tech Specs	20
Dimensional Drawings	21
Internal/External Parts	22

LITHIUM-ION BATTERY WARNINGS & INFO

YOU MUST READ THESE SAFETY INSTRUCTIONS AND WARNINGS BEFORE USING OR CHARGING YOUR FIXTURES.

LI-ION BATTERIES ARE VOLATILE. FAILURE TO READ AND FOLLOW THE BELOW INSTRUCTIONS MAY RESULT IN FIRE, PERSONAL INJURY AND DAMAGE TO PROPERTY IF CHARGED OR USED IMPROPERLY. BY PURCHASING AND USING THESE FIXTURES, YOU ASSUME ALL RISKS ASSOCIATED WITH LITHIUM BATTERIES. IF YOU DO NOT AGREE WITH THESE CONDITIONS, PLEASE CONSIDER RETURNING THE FIXTURES

- 1. WARNING! TO REDUCE THE RISK OF INJURY AND/OR EQUIPMENT DAMAGE, DO NOT TAMPER WITH THE CHARGING CIRCUITRY IN THIS FIXTURE.** The use of other types of chargers may result in personal injury or equipment damage. Under no circumstances attempt to connect the battery pack to any power supplies or other equipment that is not specifically and expressly designated for use with this model battery pack.
- 2. NEVER CHARGE UNATTENDED.** When charging Li-Ion batteries, you must always remain in constant observation in order to react to potential problems which may occur. Failure to do so may result in fire. Put the battery in a fireproof container, and charge in an isolated area, away from flammable materials. Always have a fire extinguisher ready for emergency use.
- 3. USE THE LITHIUM ION BATTERY PACK ONLY WITH EQUIPMENT SPECIFICALLY AND EXPRESSLY DESIGNATED FOR USE WITH THIS MODEL BATTERY PACK.** Use with other equipment may result in fire, electric shock, personal injury, and/or damage to equipment.
- 4. AVOID DANGEROUS CONDITIONS AND ENVIRONMENTS.** Do not charge the battery pack in damp or wet conditions. Avoid using the pack in direct exposure to rain or snow. Do not use the battery pack or charger in the presence of explosive gases or flammable materials.
- 5. AVOID USING OR STORING THE BATTERY PACK IN EITHER EXTREME COLD OR EXTREME HOT TEMPERATURES.** The battery pack will disable itself under conditions of extreme heat (above 60 °C) and may not function to full performance under conditions of extreme cold (below -20 °C). Storage at elevated temperatures (above 25 °C) will shorten the life of the battery pack.
- 6. DO NOT BURN OR INCINERATE BATTERY PACKS.** Battery packs may explode causing personal injury, fire, and/or damage. Fumes resulting from burning of battery packs may be toxic.
- 7. DO NOT DROP, CRUSH, IMPACT, OR MECHANICALLY ABUSE BATTERY PACKS.** Cease use of fixtures that have suffered a sharp impact, been dropped, run over, or damaged in any other way. Such impacts may cause internal damage that is not externally visible and that, over time, may cause short circuits, battery cell leakage, or other events that may lead to fire, personal injury, and or equipment damage.
- 8. DO NOT DISASSEMBLE BATTERY PACK.** There are no user serviceable parts within battery packs. Disassembly may result in short circuiting or other damage that may cause fire, personal injury, and/or other damage.
- 9. AVOID CONTACT WITH BATTERY CHEMICALS.** If a battery pack leaks battery chemicals, avoid any contact with skin, eyes, or mouth. In the event of contact with skin, wash immediately with soap and water and rinse with vinegar. For eye contact, begin flushing with clean water, immediately call for medical help, and continue flushing for 20 minutes or until medical help arrives.
- 10. STORE IN A COOL, DRY PLACE.** Avoid leaving the fixture in direct sunlight, vehicle cabs, compartments, or unventilated storage buildings during hot summer conditions. Under extreme temperature conditions damage may occur. Elevated temperatures in general shorten the life of your battery pack.

1. GETTING STARTED

What's In The Box?

- 1 x TOURnado Sky W-DMX™ Professional LED PAR Fixture
- An Ever-So-Handy Power Cord
- This Lovely User Manual

Getting It Out Of The Box

Congratulations! You're now the proud owner of one tough, slightly pumpkin shaped PAR fixture! Now that you've got your TOURnado Sky W-DMX™ (or hopefully, *TOURNADOS!*), you should carefully unpack the box and check the contents to ensure that all parts are present and in good condition. If anything looks as if it has been damaged in transit, notify the shipper immediately and keep the packing material for inspection. Again, please save the carton and all packing materials. If a fixture must be returned to the factory, it is important that the fixture be returned in the original factory box and packing.

Powering Up!

All fixtures must be powered directly off a switched circuit and **cannot be run off a rheostat (variable resistor) or dimmer circuit, even if the rheostat or dimmer channel is used solely for a 0% to 100% switch.**

AC Voltage Switch - Not all fixtures have a voltage select switch, so please verify that the fixture you receive is suitable for your local power supply. See the label on the fixture or refer to the fixture's specifications chart for more information. A fixture's listed current rating is its average current draw under normal conditions. Check the fixture or device carefully to make sure that if a voltage selection switch exists that it is set to the correct line voltage you will use.

Warning! Verify that the voltage select switch on your unit matches the line voltage applied. Damage to your fixture may result if the line voltage applied does not match the voltage indicated on the voltage selector switch. All fixtures must be connected to circuits with a suitable Ground (Earthing).

Getting A Hold Of Us

If something is wrong, please just visit our website at www.blizzardlighting.com/support and open a support ticket. We'll be happy to help, honest.

Disclaimer: The information and specifications contained in this document are subject to change without notice. Blizzard Lighting™ assumes no responsibility or liability for any errors or omissions that may appear in this user manual. Blizzard Lighting™ reserves the right to update the existing document or to create a new document to correct any errors or omissions at any time. You can download the latest version of this document from www.blizzardlighting.com.

Author:	Date:	Last Edited:	Date:
J. Thomas	3/4/2015	J. Thomas	10/11/2018

SAFETY INSTRUCTIONS



Please read these instructions carefully. They include important information about the installation, usage and maintenance of this product.

- Please keep this User Guide for future use. If you sell the unit to someone else, be sure that they also receive this User Guide.
- ALWAYS make sure that you are connecting to the proper voltage, and that the line voltage you are connecting to is not higher than that stated on the decal or rear panel of the fixture.
- Make sure there are no flammable materials close to the unit while operating.
- The unit must be installed in a location with adequate ventilation, at least 20in (50cm) from adjacent surfaces. Be sure that no ventilation slots are blocked.
- ALWAYS disconnect from the power source before servicing or replacing fuse and be sure to replace with same fuse size and type.
- ALWAYS secure fixture using a safety chain. NEVER carry the fixture by its cord. Use its carrying handles.
- DO NOT operate at ambient temperatures higher than 104°F (40°C).
- In the event of a serious operating problem, stop using the unit immediately. NEVER try to repair the unit by yourself. Repairs carried out by unskilled people can lead to damage or malfunction. Please contact the nearest authorized technical assistance center. Always use the same type spare parts.
- NEVER connect the device to a dimmer pack.
- Make sure the power cord is never crimped or damaged.
- Never disconnect the power cord by pulling or tugging on the cord.
- Avoid direct eye exposure to the light source while it is on.

Caution! There are no user serviceable parts inside this unit. Do not open the housing or attempt any repairs yourself. In the unlikely event your unit may require service, please visit www.blizzardlighting.com/support.

2. MEET THE TOURNADO SKY W-DMX™ LED PAR

CONTROL FEATURES

- RGBAW+UV color mixing via 7x 15W 6-in-1 LEDs
- 2.4Ghz built-in wireless W-DMX™ receiver
- Ultra Long-life intelion™ lithium-ion battery system
- Variable electronic dimming & strobe
- Built-in color & chase macros via DMX
- Built-in automated programs via master/slave
- RGBAW+UV color mixing ability in standalone mode
- RGBAW+UV (6-Ch), RGBAW+UV/Strobe (7-Ch), RGBAW+UV/Dimmer/Strobe (7-Ch), & Extended w/32-bit Dimmer (11-Ch) DMX Profiles

ADDITIONAL FEATURES

- Rugged and well-built (It hits the gym regularly)
- Convection cooled cast aluminum housing
- Dual mounting brackets for positioning flexibility
- Flicker-free constant-current 400hz LED driver
- 3-pin male input and 3-pin female output
- Locking power input and 3-pin DMX connections

DMX Quick Reference - 11/8 Channel Modes

Channel	11-Channel	8-Channel
1	Dimmer	Dimmer
2	Red Intensity	Red Intensity
3	Green Intensity	Green Intensity
4	Blue Intensity	Blue Intensity
5	Amber Intensity	Amber Intensity
6	White Intensity	White Intensity
7	UV Intensity	UV Intensity
8	Strobe	Strobe
9	Static Colors + Auto Run	---
10	Built-in Programs	---
11	32-Bit Dimmer	---

DMX Quick Reference - 7/6 Channel Modes

Channel	7-Channel	6-Channel
1	Red Intensity	Red Intensity
2	Green Intensity	Green Intensity
3	Blue Intensity	Blue Intensity
4	Amber Intensity	Amber Intensity
5	White Intensity	White Intensity
6	UV Intensity	UV Intensity
7	Strobe	---

Figure 1: The TOURnado Sky W-DMX™ Pin-Up Picture



Figure 2: The Rear Connections



3. SETUP

Connecting A Bunch of TOURnado Sky W-DMX™ Fixtures

You will need a serial data link to run light shows using a DMX-512 controller or to run shows on two or more fixtures set to sync in master/slave operating mode. The combined number of channels required by all the fixtures on a serial data link determines the number of fixtures the data link can support.

Fixtures on a serial data link must be daisy chained in one single line. Also, connecting more than 32 fixtures on one serial data link without the use of a DMX optically-isolated splitter may result in deterioration of the digital DMX signal. The maximum recommended cable-run distance is 500 meters (1640 ft). The maximum recommended number of fixtures on a serial data link is 32 fixtures.

Data/DMX Cabling

To link fixtures together you'll need data cables. You should use data-grade cables that can carry a high quality signal and are less prone to electromagnetic interference.

For instance, Belden© 9841 meets the specifications for EIA RS-485 applications. Standard microphone cables will "probably" be OK, but note that they cannot transmit DMX data as reliably over long distances. In any event, the cable should have the following characteristics:

*2-conductor twisted pair plus a shield
Maximum capacitance between conductors – 30 pF/ft.
Maximum capacitance between conductor & shield – 55 pF/ft.
Maximum resistance of 20 ohms / 1000 ft.
Nominal impedance 100 – 140 ohms*

Using The Built-in W-DMX™

In addition to the unbridled thrill you already received the first time you turned on your fixture, you'll be delighted to know that the TOURnado Sky W-DMX™ built-in wireless system is designed to work seamlessly with any W-DMX™ products. W-DMX™ is a two-time award winning wireless DMX technology, created and owned by Wireless Solution Sweden AB.

To use the built-in W-DMX™ receiver, you will first need a W-DMX™ transmitter or transceiver to broadcast the signal, such as our own LightCaster™ W-DMX™ transceiver unit. Paired up with a LightCaster™ W-DMX™ transceiver, you can expect an outstanding wireless range of up to 500 meters (line-of-sight), and leave any worries behind concerning loss of signal due to its built-in FHSS technology (Frequency Hopping Spread Spectrum).

FHSS are frequency hopping techniques, in which the transmitter jumps from one sub-channel to another at a very rapid pace. This technique was first used by the U.S. military precisely because they are difficult to disrupt, and unless you knew the frequency hopping sequence, practically impossible to intercept.

Make sure to read the instruction manual of your LightCaster™ W-DMX™, or other W-DMX™ transmission device for other product specific setup information.

WIRELESS SOLUTION
MADE IN SWEDEN



Ready to move on? Well alrighty!

If you're using an external wireless W-DMX transmitter like our LightCaster™ W-DMX™ transceiver, plug it into the "DMX OUT" connector of the controller and verify it is receiving power.

1. One transceiver with multiple receivers:
 - a.) Power on all units. The DMX LED indicator on the LightCaster™ W-DMX™ transceiver should be off (if its on or flashing, press & hold the **<FUNCTION>** button until it turn off), then press the transceiver's **<FUNCTION>** button again.
 - b.) On the receiving W-DMX fixtures, use the control panel menu to navigate to WDMX, and press the **<ENTER>** button.
 - c.) Press and hold down the **<ENTER>** button for 3 seconds to sync. All the receiving fixtures should be matched up correctly.
2. Multiple transceivers, multiple receivers; e.g. 3 groups consisting of a transceiver & receiver(s) named A, B, and C:
 - 1.) Turn power off of all units.
 - 2.) Group "A" gets powered on, then follow step 1 above.
 - 3.) Group "B" gets powered on, then follow step 1 above.
 - 4.) Group "C" gets powered on, then follow step 1 above.

Using the Intelion™ Battery System

The TOURnado Sky W-DMX™ features our proprietary Intelion™ Lithium-Ion internal battery system which allows you the flexibility to operate your fixture without AC power for up to 20 hours.

To charge the battery, simply plug the fixture into a power source. The battery will charge whether the fixture is powered on or off. The built-in microprocessor of the battery system controls the charge and overall battery health, so all you need to do is plug and play.

On the top left corner of the LED display, there is an LED battery charge status indicator that will illuminate in **RED** while charging, then **GREEN** when charging is complete. Please note, when the LED display goes into lockout mode, which happens after 20s of idle (touch any button for 10s to unlock), the display will show the current percentage of power remaining from 0-100% (**P000-P100**).

A full charge is obtained after charging for at least 4 hours. The fixture will automatically stop charging when the battery is in optimal condition.



Power Output Mode:

Depending on the needs of any given application, you can select either High Power, Medium Power, or Battery Saver Mode, which allows the fixture to run for a longer time at lower output.

- a.) Press the **<MENU>** button until the display reads **OUT MOD**.
- b.) Use the **<UP/DOWN>** buttons to select **H (100%)**, **M (75%)** or **S (50%)**.
- c.) Press **<ENTER>** to confirm the setting.

Note: With average usage of color fades in *High Output Mode*, you can expect the battery life to last up to 10+ hours, color jumping 5+ hrs, or full on for 3+ hrs. Display color/fade/chase/strobe, and environmental factors including ambient temperature will all impact battery life.

Cable Connectors

Cables must have a male XLR connector on one end and a female XLR connector on the other end. (Duh!)

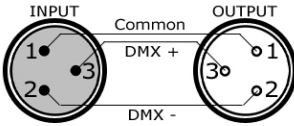

A Word on Termination: DMX is a resilient communication protocol, however errors still occasionally occur. Termination reduces signal errors, and therefore best practices include use of a terminator in all circumstances. If you are experiencing problems with erratic fixture behavior, especially over long signal cable runs, a terminator may help improve performance.

To build your own DMX Terminator:
Obtain a 120-ohm, 1/4-watt resistor, and wire it between pins 2 & 3 of the last fixture. They are also readily available from specialty retailers.

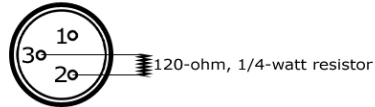

CAUTION: Do not allow contact between the common and the fixture's chassis ground. Grounding the common can cause a ground loop, and your fixture may perform erratically. Test cables with an ohm meter to verify correct polarity and to make sure the pins are not grounded or shorted to the shield or each other.

3-Pin??? 5-Pin??? Huh?!?

If you use a controller with a 5 pin DMX output connector, you will need to use a 5 pin to 3 pin adapter. They are widely available over the internet and from specialty retailers. If you'd like to build your own, the chart below details a proper cable conversion:

Conductor	3-Pin Female (Output)	5-Pin Male (Input)
Ground/Shield	Pin 1	Pin 1
DMX Data (-)	Pin 2	Pin 2
DMX Data (+)	Pin 3	Pin 3
Not Used.	No Connection.	No Connection.
Not Used.	No Connection.	No Connection.

Take It To The Next Level: Setting Up DMX Control

Step 1: Connect the male connector of the DMX cable to the female connector (output) on the controller.

Step 2: Connect the female connector of the DMX cable to the first fixture's male connector (input). *Note:* It doesn't matter which fixture address is the first one connected. We recommend connecting the fixtures in terms of their proximity to the controller, rather than connecting the lowest fixture number first, and so on.

Step 3: Connect other fixtures in the chain from output to input as above. Place a DMX terminator on the output of the final fixture to ensure best communication.

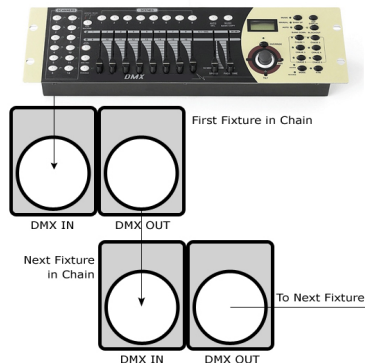

Fixture Linking (Master/Slave Mode)

1. Connect the (male) 3 pin connector side of the DMX cable to the output (female) 3 pin connector of the first fixture.
2. Connect the end of the cable coming from the first fixture which will have a (female) 3 pin connector to the input connector of the next fixture consisting of a (male) 3 pin connector. Then, proceed to connect from the output as stated above to the input of the following fixture and so on.

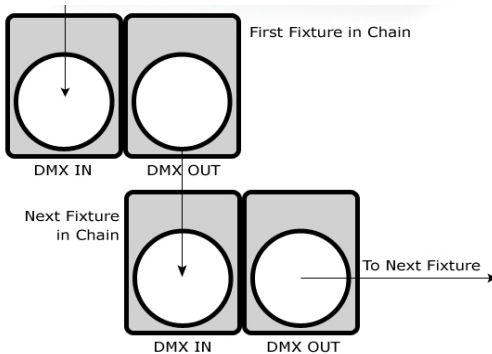

A quick note: Often, the setup for Master-Slave and Standalone operation requires that the first fixture in the chain be initialized for this purpose via either settings in the control panel or DIP-switches. Secondly, the fixtures that follow may also require a slave setting.

Check the **“Operating Adjustments”** section in this manual for complete instructions for this type of setup and configuration.

Mounting & Rigging

This fixture may be mounted in any SAFE position provided there is enough room for ventilation.

It is important never to obstruct the fan or vents pathway. Mount the fixture using a suitable “C” or “O” type clamp. The clamp should be rated to hold at least 10x the fixture’s weight to ensure structural stability. Do not mount to surfaces with unknown strength, and ensure properly “rated” rigging is used when mounting fixtures overhead.

Adjust the angle of the fixture by loosening both knobs and tilting the fixture. After finding the desired position, retighten both knobs.

- When selecting installation location, take into consideration lamp replacement access (if applicable) and routine maintenance.
- Safety cables **MUST ALWAYS** be used.

4. OPERATING ADJUSTMENTS

The Control Panel

All the goodies and different modes possible with the TOURnado Sky W-DMX™ are accessed by using the control panel on the rear of the fixture. There are 4 control buttons below the LED display which allow you to navigate through the various control panel menus.

<MENU>

Is used to navigate to the previous higher-level menu item.

<UP>

Scrolls through menu items and numbers in ascending order.

<DOWN>

Scrolls through menu items and numbers in descending order.

<ENTER>

Is used to select and confirm/store the current selection.

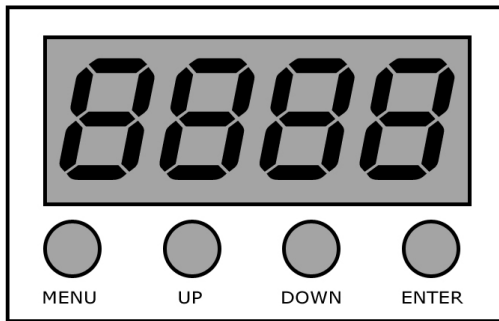

The control panel LED display shows the menu items you select from the menu map on page #13. When a menu function is selected, the display will show immediately the first available option for the selected menu function. To select a menu item, press **<ENTER>**.

Use the **<UP>** and **<DOWN>** buttons to navigate the menu options. Press the **<ENTER>** button to select the menu function currently displayed, or to enable a menu option. To return to the previous option or menu, press the **<MENU>** button.

Control Panel Menu Structure

<i>Addr</i>	<i>d001 - d512</i>	To choose the DMX address
<i>SLAVE</i>	<i>SLAVE</i>	To run the fixture in slave mode
<i>CHnd</i>	<i>11CH</i>	11-channel DMX mode
	<i>8CH</i>	8-channel DMX mode
	<i>7CH</i>	7-channel DMX mode
	<i>6CH</i>	6-channel DMX mode
<i>modE</i>	<i>mod0 - mod4</i>	Dimming mode (0-4)
<i>SP --</i>	<i>SP00 - SP15</i>	Speed adjustments (0-15)
<i>Pr --</i>	<i>Pr00 - Pr63</i>	Built-in programs (0-63)
<i>ASC -</i>	<i>AC00 - AC15</i>	Auto mode (0-15)
<i>FAde</i>	<i>FA00 - FA15</i>	Fade settings (0-15)
<i>FLAS</i>	<i>FL00 - FL15</i>	Flash / strobe speed (0-15)
<i>rL --</i>	<i>r000 - r255</i>	Red dimmer (0% <--> 100%)
<i>gL --</i>	<i>g000 - g255</i>	Green dimmer (0% <--> 100%)
<i>bl --</i>	<i>b000 - b255</i>	Blue dimmer (0% <--> 100%)
<i>AL --</i>	<i>A000 - A255</i>	Amber dimmer (0% <--> 100%)
<i>UL --</i>	<i>U000 - U255</i>	White dimmer (0% <--> 100%)
<i>uL --</i>	<i>U000 - U255</i>	UV dimmer (0% <--> 100%)
<i>LED</i>	<i>on - off</i>	Display menu on/off
<i>WDMX</i>	<i>SET</i>	Wireless reset
<i>OUT</i>	<i>H - M - S</i>	Power output: 100%, 75%, 50%

LED Display Menu Lock:

As a safety feature, the LED control panel display will automatically lock after 20 seconds of inactivity. To unlock it, press the buttons in this order: **<MENU>**, **<UP>**, **<DOWN>**, **<ENTER>**, **<MENU>**, **<UP>**, **<DOWN>**, **<ENTER>**, **<MENU>**, **<UP>**, **<DOWN>**, **<ENTER>** with no longer than 3 seconds between each button press.

Also note, during this locked period the display will show the current percentage of power remaining in the battery from 0-100% (**P000-P100**).

DMX Mode

Allows the unit to be controlled by any universal DMX controller.

Set the Starting DMX Address:

The default mode for the fixture is DMX, so the first menu item that you can edit is the starting DMX address.

- 1.) Navigate the menu using the **<UP/DOWN>** buttons until you reach **Addr.**
- 2.) Push the **<ENTER>** button.
- 3.) Use the **<UP/DOWN>** buttons to select a DMX channel from **001-512**.
- 4.) Press the **<ENTER>** button to confirm.

Select the DMX Channel Mode:

- 1.) Navigate the menu using the **<UP/DOWN>** buttons until you reach **CHnd.**
- 2.) Push the **<ENTER>** button.
- 3.) Use the **<UP/DOWN>** buttons to select either **6CH, 7CH, 8ch** or **11CH** mode.
- 4.) Press the **<ENTER>** button to confirm.

Slave Mode:

To synchronize one or more fixtures to follow the actions of the Master fixture (the 1st unit in the DMX chain), perform the following steps on each Slave fixture:

- 1.) Set the DMX address to **d001**.
- 2.) Navigate the menu using the **<UP/DOWN>** button until you reach **SLAU**.
- 3.) Push the **<ENTER>** button.
- 4.) Use the **<UP/DOWN>** buttons to select **SLAU**.
- 5.) Press the **<ENTER>** button to confirm.

Auto, Stand-Alone, & Built-in Program Modes:

Allows a single or Master/Slaved units to run factory installed programs at user selectable speeds.

Auto Mode:

- 1.) Navigate the menu using the **<UP/DOWN>** button until you reach **ASC-**.
- 2.) Push the **<ENTER>** button.
- 3.) Use the **<UP/DOWN>** buttons to select from **AC00-AC15**.
- 4.) Press the **<ENTER>** button to confirm.

Standalone (Program) Mode:

Allows a single unit to display a variety of colors and programs without a DMX controller.

- 1.) Navigate the menu using the **<UP/DOWN>** button until you reach **Pr--**.
- 2.) Push the **<ENTER>** button.
- 3.) Use the **<UP/DOWN>** buttons to select from **Pr00-Pr63**.
- 4.) Press the **<ENTER>** button to confirm.

Flash/Fade Modes:

- 1.) Navigate the menu using the **<UP/DOWN>** buttons until you reach **FLAS** or **FAdE**.
- 2.) Push the **<ENTER>** button.
- 3.) Now, you can adjust the flash rate from **FL00-FL15** or the fade speed from **FA00-FA15** with the **<UP/DOWN>** buttons. Press the **<ENTER>** button to confirm.

Built-in Program Speed:

- 1.) Navigate the menu using the **<UP/DOWN>** button until you reach **SP-**.
- 2.) Push the **<ENTER>** button.
- 3.) Use the **<UP/DOWN>** buttons to select from **SP00-SP15**.
- 4.) Press the **<ENTER>** button to confirm.

Manual Color Adjustment:

- 1.) Navigate the menu using the **<UP/DOWN>** button until you reach either **rL--** (Red), **gL--** (Green), **bL--** (Blue), **AL--** (Amber), **UL--** (White), or **uL--** (UV) then hit **<ENTER>**.
- 2.) Using the **<UP/DOWN>** buttons, select the maximum level for each color between **x000-x255** (000=off), then hit **<ENTER>** to confirm.

Dimming Mode

Each allows for different amounts of steps for much smoother (and slower) dimming capabilities.

- 1.) Navigate the menu using the **<UP/DOWN>** buttons until you reach **nodE**.
- 2.) Push the **<ENTER>** button.
- 3.) Use the **<UP/DOWN>** buttons to select **nod0-nod4**.
- 4.) Press the **<ENTER>** button to confirm.

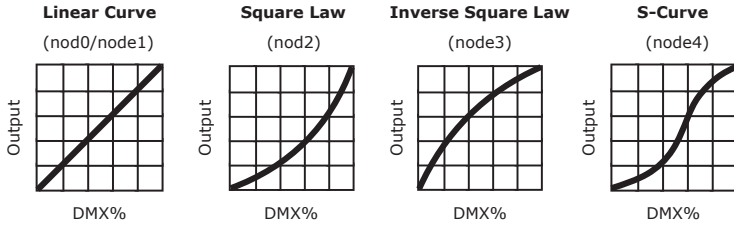

DMX Values In-Depth (6-Channel Mode)

Channel	Value	What It Does
1	000 <--> 255	Red Intensity (0% <--> 100%)
2	000 <--> 255	Green Intensity (0% <--> 100%)
3	000 <--> 255	Blue Intensity (0% <--> 100%)
4	000 <--> 255	Amber Intensity (0% <--> 100%)
5	000 <--> 255	White Intensity (0% <--> 100%)
6	000 <--> 255	UV Intensity (0% <--> 100%)

DMX Values In-Depth (7-Channel Mode)

Channel	Value	What It Does
1	000 <--> 255	Red Intensity (0% <--> 100%)
2	000 <--> 255	Green Intensity (0% <--> 100%)
3	000 <--> 255	Blue Intensity (0% <--> 100%)
4	000 <--> 255	Amber Intensity (0% <--> 100%)
5	000 <--> 255	White Intensity (0% <--> 100%)
6	000 <--> 255	UV Intensity (0% <--> 100%)
7	000 <--> 009 010 <--> 255	Strobe No Function Strobe (Slow <--> Fast)

DMX Values In-Depth (8-Channel Mode)

Channel	Value	What It Does
1	000 <--> 255	Dimmer (0% <--> 100%)
2	000 <--> 255	Red Intensity (0% <--> 100%)
3	000 <--> 255	Green Intensity (0% <--> 100%)
4	000 <--> 255	Blue Intensity (0% <--> 100%)
5	000 <--> 255	Amber Intensity (0% <--> 100%)
6	000 <--> 255	White Intensity (0% <--> 100%)
7	000 <--> 255	UV Intensity (0% <--> 100%)
8	000 <--> 009 010 <--> 255	Strobe No Function Strobe (Slow <--> Fast)

DMX Values In-Depth (11-Channel Mode)

Channel	Value	What It Does																																																																																																			
1	000 <--> 255	Dimmer (0% <--> 100%)																																																																																																			
2	000 <--> 255	Red Intensity (0% <--> 100%)																																																																																																			
3	000 <--> 255	Green Intensity (0% <--> 100%)																																																																																																			
4	000 <--> 255	Blue Intensity (0% <--> 100%)																																																																																																			
5	000 <--> 255	Amber Intensity (0% <--> 100%)																																																																																																			
6	000 <--> 255	White Intensity (0% <--> 100%)																																																																																																			
7	000 <--> 255	UV Intensity (0% <--> 100%)																																																																																																			
8	000 <--> 009 010 <--> 255	Strobe No Function Strobe (Slow <--> Fast)																																																																																																			
9		Static Colors + Auto Mode																																																																																																			
	000 <--> 015 016 <--> 018 019 <--> 021 022 <--> 024 025 <--> 027 028 <--> 030 031 <--> 033 034 <--> 036 037 <--> 039 040 <--> 042 043 <--> 045 046 <--> 048 049 <--> 051 052 <--> 054 055 <--> 057 058 <--> 060 061 <--> 063 064 <--> 066 067 <--> 069 070 <--> 072 073 <--> 075 076 <--> 078 079 <--> 081 082 <--> 084 085 <--> 087 088 <--> 090 091 <--> 093 094 <--> 096 097 <--> 099 100 <--> 102 103 <--> 105 106 <--> 108 109 <--> 111	<table border="1"> <thead> <tr> <th>Dimming</th> <th></th> <th></th> </tr> </thead> <tbody> <tr><td>Red</td><td>112 <--> 114</td><td>G+B+W</td></tr> <tr><td>Green</td><td>115 <--> 117</td><td>G+B+UV</td></tr> <tr><td>Blue</td><td>118 <--> 120</td><td>G+A+W</td></tr> <tr><td>Amber</td><td>121 <--> 123</td><td>G+A+UV</td></tr> <tr><td>White</td><td>124 <--> 126</td><td>G+W+UV</td></tr> <tr><td>UV</td><td>127 <--> 129</td><td>B+A+W</td></tr> <tr><td>R+G</td><td>130 <--> 132</td><td>B+A+UV</td></tr> <tr><td>R+B</td><td>133 <--> 135</td><td>B+W+UV</td></tr> <tr><td>R+A</td><td>136 <--> 138</td><td>A+W+UV</td></tr> <tr><td>R+W</td><td>139 <--> 141</td><td>R+G+B+A</td></tr> <tr><td>R+UV</td><td>142 <--> 144</td><td>R+G+B+W</td></tr> <tr><td>G+B</td><td>145 <--> 147</td><td>R+G+B+UV</td></tr> <tr><td>G+A</td><td>148 <--> 150</td><td>R+G+A+W</td></tr> <tr><td>G+W</td><td>151 <--> 153</td><td>R+G+A+UV</td></tr> <tr><td>G+UV</td><td>154 <--> 156</td><td>R+G+W+UV</td></tr> <tr><td>B+A</td><td>157 <--> 159</td><td>R+B+A+W</td></tr> <tr><td>B+W</td><td>160 <--> 162</td><td>R+B+A+UV</td></tr> <tr><td>B+UV</td><td>163 <--> 165</td><td>R+B+W+UV</td></tr> <tr><td>A+W</td><td>166 <--> 168</td><td>R+A+W+UV</td></tr> <tr><td>A+UV</td><td>169 <--> 171</td><td>G+B+A+W</td></tr> <tr><td>W+UV</td><td>172 <--> 174</td><td>G+B+A+UV</td></tr> <tr><td>R+G+B</td><td>175 <--> 177</td><td>G+B+W+UV</td></tr> <tr><td>R+G+A</td><td>178 <--> 180</td><td>G+A+W+UV</td></tr> <tr><td>R+G+W</td><td>181 <--> 183</td><td>B+A+W+UV</td></tr> <tr><td>R+G+UV</td><td>184 <--> 186</td><td>R+G+B+A+W</td></tr> <tr><td>R+B+A</td><td>187 <--> 189</td><td>R+G+B+A+UV</td></tr> <tr><td>R+B+W</td><td>190 <--> 192</td><td>R+G+B+W+UV</td></tr> <tr><td>R+B+UV</td><td>193 <--> 195</td><td>R+G+A+W+UV</td></tr> <tr><td>R+A+W</td><td>196 <--> 198</td><td>R+B+A+W+UV</td></tr> <tr><td>R+A+UV</td><td>199 <--> 201</td><td>G+B+A+W+UV</td></tr> <tr><td>R+W +UV</td><td>202 <--> 204</td><td>R+G+B+A+W+UV</td></tr> <tr><td>G+B+A</td><td>205 <--> 255</td><td>Auto Run (Slow <--> Fast)</td></tr> </tbody> </table>	Dimming			Red	112 <--> 114	G+B+W	Green	115 <--> 117	G+B+UV	Blue	118 <--> 120	G+A+W	Amber	121 <--> 123	G+A+UV	White	124 <--> 126	G+W+UV	UV	127 <--> 129	B+A+W	R+G	130 <--> 132	B+A+UV	R+B	133 <--> 135	B+W+UV	R+A	136 <--> 138	A+W+UV	R+W	139 <--> 141	R+G+B+A	R+UV	142 <--> 144	R+G+B+W	G+B	145 <--> 147	R+G+B+UV	G+A	148 <--> 150	R+G+A+W	G+W	151 <--> 153	R+G+A+UV	G+UV	154 <--> 156	R+G+W+UV	B+A	157 <--> 159	R+B+A+W	B+W	160 <--> 162	R+B+A+UV	B+UV	163 <--> 165	R+B+W+UV	A+W	166 <--> 168	R+A+W+UV	A+UV	169 <--> 171	G+B+A+W	W+UV	172 <--> 174	G+B+A+UV	R+G+B	175 <--> 177	G+B+W+UV	R+G+A	178 <--> 180	G+A+W+UV	R+G+W	181 <--> 183	B+A+W+UV	R+G+UV	184 <--> 186	R+G+B+A+W	R+B+A	187 <--> 189	R+G+B+A+UV	R+B+W	190 <--> 192	R+G+B+W+UV	R+B+UV	193 <--> 195	R+G+A+W+UV	R+A+W	196 <--> 198	R+B+A+W+UV	R+A+UV	199 <--> 201	G+B+A+W+UV	R+W +UV	202 <--> 204	R+G+B+A+W+UV	G+B+A	205 <--> 255	Auto Run (Slow <--> Fast)
Dimming																																																																																																					
Red	112 <--> 114	G+B+W																																																																																																			
Green	115 <--> 117	G+B+UV																																																																																																			
Blue	118 <--> 120	G+A+W																																																																																																			
Amber	121 <--> 123	G+A+UV																																																																																																			
White	124 <--> 126	G+W+UV																																																																																																			
UV	127 <--> 129	B+A+W																																																																																																			
R+G	130 <--> 132	B+A+UV																																																																																																			
R+B	133 <--> 135	B+W+UV																																																																																																			
R+A	136 <--> 138	A+W+UV																																																																																																			
R+W	139 <--> 141	R+G+B+A																																																																																																			
R+UV	142 <--> 144	R+G+B+W																																																																																																			
G+B	145 <--> 147	R+G+B+UV																																																																																																			
G+A	148 <--> 150	R+G+A+W																																																																																																			
G+W	151 <--> 153	R+G+A+UV																																																																																																			
G+UV	154 <--> 156	R+G+W+UV																																																																																																			
B+A	157 <--> 159	R+B+A+W																																																																																																			
B+W	160 <--> 162	R+B+A+UV																																																																																																			
B+UV	163 <--> 165	R+B+W+UV																																																																																																			
A+W	166 <--> 168	R+A+W+UV																																																																																																			
A+UV	169 <--> 171	G+B+A+W																																																																																																			
W+UV	172 <--> 174	G+B+A+UV																																																																																																			
R+G+B	175 <--> 177	G+B+W+UV																																																																																																			
R+G+A	178 <--> 180	G+A+W+UV																																																																																																			
R+G+W	181 <--> 183	B+A+W+UV																																																																																																			
R+G+UV	184 <--> 186	R+G+B+A+W																																																																																																			
R+B+A	187 <--> 189	R+G+B+A+UV																																																																																																			
R+B+W	190 <--> 192	R+G+B+W+UV																																																																																																			
R+B+UV	193 <--> 195	R+G+A+W+UV																																																																																																			
R+A+W	196 <--> 198	R+B+A+W+UV																																																																																																			
R+A+UV	199 <--> 201	G+B+A+W+UV																																																																																																			
R+W +UV	202 <--> 204	R+G+B+A+W+UV																																																																																																			
G+B+A	205 <--> 255	Auto Run (Slow <--> Fast)																																																																																																			
10	000 <--> 015 016 <--> 255	Auto Mode No Function Color Jump (Slow <--> Fast)																																																																																																			
11	000 <--> 005 006 <--> 055 056 <--> 105 106 <--> 155 156 <--> 205 206 <--> 255	32-Bit Dimmer As set in the control menu display Mode 0 = 8-bit, Linear Curve Mode 1 = 32-bit, Linear Curve (Smooth) Mode 2 = 32-bit, S-Curve (Smooth) Mode 3 = 32-bit, Inverse Square Law Curve (Smooth) Mode 4 = 32-bit, Square Law Curve (Smooth)																																																																																																			

Troubleshooting

Symptom	Solution
Fixture Auto-Shut Off	Check the fan in the fixture. If it is stopped or moving slower than normal, the unit may have shut itself off due to high heat. This is to protect the fixture from overheating. Clear the fan of obstructions, or return the unit for service.
Beam is Dim	Check optical system and clean excess dust/grime. Also ensure that the 220V/110V switch is in the correct position, if applicable.
No Light Output	Check to ensure fixture is operating under correct mode, IE auto/DMX/Etc., if applicable.
Chase Speed Too Fast/Slow	Check to ensure proper setup of speed adjustment.
No Power	Check fuse, AC cord and circuit for malfunction.
Blown Fuse	Check AC cord and circuit for damage, verify that moving parts are not restricted and that unit's ventilation is not obstructed
Slow Movement	Verify that 220V/110V switch is in the correct position, if applicable. Also check that speed channels are set appropriately.
Fixture Not Responding / Responding Erratically	Make sure all connectors are seated properly and securely. Use Only DMX Cables and/or check cables for defects. Install a Terminator. Reset fixture(s).
Intermittent Lamp	Check lamp for properly installation. Relamp, lamp may have reached end of life.
Remote Doesn't Work	Verify remote control cable is installed properly and securely. Verify remote is correct type (CA-9 or other as applicable.)
Fixture Moving On Its Own	Verify proper mode of operation. Is the fixture in "Auto" mode?

If your problem persists or isn't listed, please open a support ticket at www.blizzardlighting.com/support.

5. APPENDIX

A Quick Lesson On DMX

DMX (aka DMX-512) was created in 1986 by the United States Institute for Theatre Technology (USITT) as a standardized method for connecting lighting consoles to lighting dimmer modules. It was revised in 1990 and again in 2000 to allow more flexibility. The Entertainment Services and Technology Association (ESTA) has since assumed control over the DMX512 standard. It has also been approved and recognized for ANSI standard classification.

DMX covers (and is an abbreviation for) Digital MultipleXed signals. It is the most common communications standard used by lighting and related stage equipment.

DMX provides up to 512 control "channels" per data link. Each of these channels was originally intended to control lamp dimmer levels. You can think of it as 512 faders on a lighting console, connected to 512 light bulbs. Each slider's position is sent over the data link as an 8-bit number having a value between 0 and 255. The value 0 corresponds to the light bulb being completely off while 255 corresponds to the light bulb being fully on.

DMX data is transmitted at 250,000 bits per second using the RS-485 transmission standard over two wires. As with microphone cables, a grounded cable shield is used to prevent interference with other signals.

There are five pins on a DMX connector: a wire for ground (cable shield), two wires for "Primary" communication which goes from a DMX source to a DMX receiver, and two wires for a "Secondary" communication which goes from a DMX receiver back to a DMX source. Generally, the "Secondary" channel is not used so data flows only from sources to receivers. Hence, most of us are most familiar with DMX-512 as being employer over typical 3-pin "mic cables," although this does not conform to the defined standard.

DMX is connected using a daisy-chain configuration where the source connects to the input of the first device, the output of the first device connects to the input of the next device, and so on. The standard allows for up to 32 devices on a single DMX link.

Each receiving device typically has a means for setting the "starting channel number" that it will respond to. For example, if two 6-channel fixtures are used, the first fixture might be set to start at channel 1 so it would respond to DMX channels 1 through 6, and the next fixture would be set to start at channel 7 so it would respond to channels 7 through 12.

The greatest strength of the DMX communications protocol is that it is very simple and robust. It involves transmitting a reset condition (indicating the start of a new "packet"), a start code, and up to 512 bytes of data. Data packets are transmitted continuously. As soon as one packet is finished, another can begin with no delay if desired (usually another follows within 1 ms). If nothing is changing (i.e. no lamp levels change) the same data will be sent out over and over again. This is a great feature of DMX -- if for some reason the data is not interpreted the first time around, it will be re-sent shortly.

Not all 512 channels need to be output per packet, and in fact, it is very uncommon to find all 512 used. The fewer channels are used, the higher the "refresh" rate. It is possible to get DMX refreshes at around 1000 times per second if only 24 channels are being transmitted. If all 512 channels are being transmitted, the refresh rate is around 44 times per second.

In summary, since its design and evolution in the 1980's DMX has become the standard for lighting control. It is flexible, robust, and scalable, and its ability to control everything from dimmer packs to moving lights to foggers to lasers makes it an indispensable tool for any lighting designer or lighting performer.

Keeping Your TOURnado Sky W-DMX™ As Good As New

The fixture you've received is a rugged, tough piece of pro lighting equipment, and as long as you take care of it, it will take care of you. That said, like anything, you'll need to take care of it if you want it to operate as designed. You should absolutely keep the fixture clean, especially if you are using it in an environment with a lot of dust, fog, haze, wild animals, wild teenagers or spilled drinks.

Cleaning the optics routinely with a suitable glass cleaner will greatly improve the quality of light output. Keeping the fans free of dust and debris will keep the fixture running cool and prevent damage from overheating.

In transit, keep the fixtures in cases. You wouldn't throw a prized guitar, drumset, or other piece of expensive gear into a gear trailer without a case, and similarly, you shouldn't even think about doing it with your shiny new light fixtures.

Common sense and taking care of your fixtures will be the single biggest thing you can do to keep them running at peak performance and let you worry about designing a great light show, putting on a great concert, or maximizing your client's satisfaction and "wow factor." That's what it's all about, after all!

Returns (Gasp!)

We've taken a lot of precautions to make sure you never even have to worry about sending a defective unit back, or sending a unit in for service. But, like any complex piece of equipment designed and built by humans, once in a while, something doesn't go as planned. If you find yourself with a fixture that isn't behaving like a good little fixture should, you'll need to obtain a Return Authorization (RA).

Don't worry, this is easy. Just open a support ticket at www.blizzardlighting.com/support, and we'll issue you an RA. Then, you'll need to send the unit to us using a trackable, pre-paid freight method. We suggest using USPS Priority or UPS. Make sure you carefully pack the fixture for transit, and whenever possible, use the original box & packing for shipping.

When returning your fixture for service, be sure to include the following:

- 1.) Your contact information (Name, Address, Phone Number, Email address).
- 2.) The RA# issued to you
- 3.) A brief description of the problem/symptoms.

We will, at our discretion, repair or replace the fixture. Please remember that any shipping damage which occurs in transit to us is the customer's responsibility, so pack it well!

Shipping Issues

Damage incurred in shipping is the responsibility of the shipper, and must be reported to the carrier immediately upon receipt of the items. Claims must be made within seven (7) days of receipt.

Tech Specs!

Weight & Dimensions								
Width	10.7 in (272 mm)							
Depth	5.7 in (144 mm)							
Height	11.2 in (284 mm)							
Weight	11.5 lbs (5.2 kg)							
Power								
Operating Voltage	100-264VAC, 47-63 Hertz							
Power Consumption	40W, .54A, PF: .58							
Light Source								
LED	7x 15W 6-in-1 LEDs 100,000 hours.							
Optical								
Beam Angle	25 degree optics standard 26 degree beam 30 degree field							
Luminous Intensity	Lux/m	Red	Green	Blue	Amber	White	UV	All
	1m	1,217	1,321	1,274	828	1,956	384	6,590
	2m	326	348	342	215	521	119	1,815
Thermal								
Max. Operating Temp.	104 degrees F (40 degrees C) ambient							
Control								
Protocol	USITT DMX-512							
DMX Channels	6 / 7 / 8 / 11							
Input	3-pin XLR Male							
Output	3-pin XLR Female							
Other Operating Modes	Standalone, Master/Slave, Color Preset							
Warranty	2-year limited warranty, does not cover malfunction caused by damage to LEDs.							

Dimensional Drawings

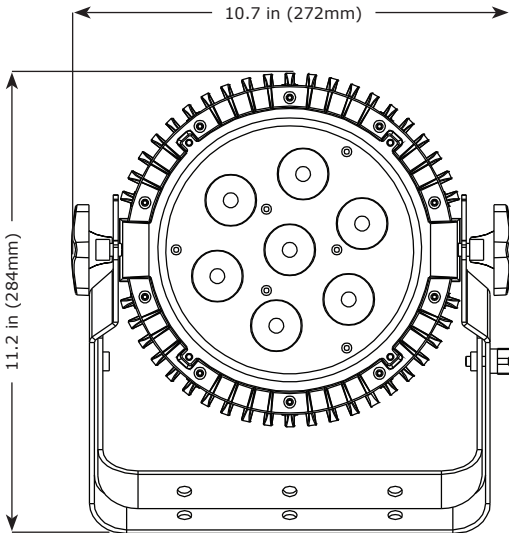
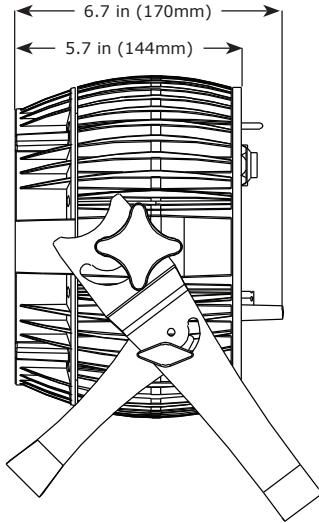

Internal/External Parts

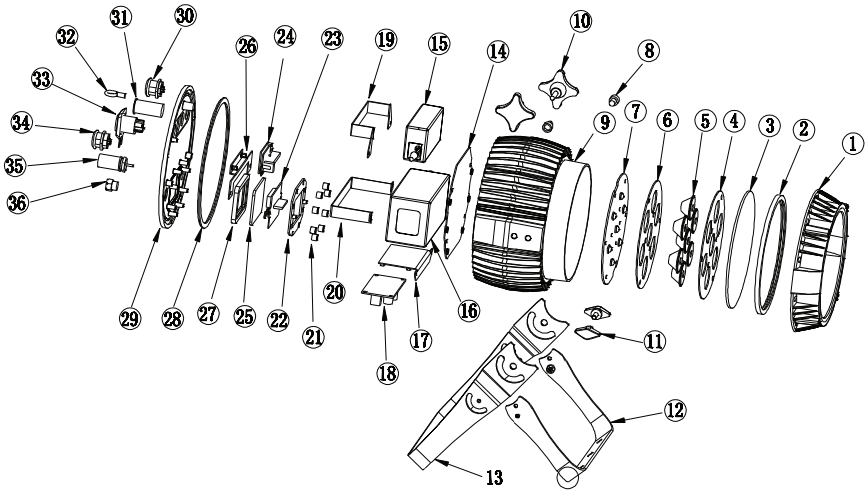

#	Name	#	Name
1.	Front cover	19.	Charger holder
2.	Waterproof silicon ring	20.	Battery holder
3.	Glass	21.	Aluminum tube
4.	Upper lens plate	22.	Waterproof display holder
5.	Lens	23.	Display
6.	Under lens plate	24.	Wireless board
7.	Aluminum plate	25.	Display glass
8.	Screw	26.	Wireless holder
9.	Body	27.	Waterproof silicon
10.	Knob	28.	Waterproof silicon
11.	Knob	29.	Back cover
12.	Inside handle	30.	DMX socket
13.	Outside handle	31.	Button
14.	Base plate	32.	Safety ring hole
15.	Charger	33.	Power socket
16.	Battery	34.	DMX socket
17.	Main board holder	35.	WDMX wireless
18.	Main board	36.	LED air valve

This page intentionally left blank.



**Enjoy your product!
Our sincerest thanks for your purchase!
--The team @ Blizzard Lighting**