

PIXELSTORM™

cob mini



WIRELESS DMX
WICICLE®
ENABLED



Blizzard Lighting, LLC
www.blizzardlighting.com
Waukesha, WI USA
Copyright (c) 2015

TABLE OF CONTENTS

PixelStorm™ COB Mini	1
1. Getting Started	3
What's In The Box?	3
Getting It Out Of The Box	3
Powering Up!	3
Getting A Hold Of Us	3
Safety Instructions (Don't Stick Your Hand In The Toaster!)	4
2. Meet The PixelStorm™ COB Mini	3
Features	5
DMX Quick Reference	5
The PixelStorm™ COB Mini Pin-up Picture	6
3. Setup	7
Fuse Replacement	7
Connecting A Bunch Of PixelStorm™ COB Mini Fixtures	7
Data/DMX Cables	7
Cable Connectors	8
3-Pin??? 5-Pin??? Huh?	8
Take It To The Next Level: Setting up DMX Control	8
Fixture Linking (Master/Slave Mode)	9
Mounting/Rigging	9
Using this fixture with the wiCICLE® Wireless DMX System	10
4. Operating Adjustments	11
Navigating The Control Panel	11
Control Panel Menu Structure	12
DMX Mode	13
Slave Mode	13
Sound Active Mode	13
Dimming Mode Settings	13
LED Display & Fan Speed Settings	13
Custom Programs	14
Auto, Speed, and Sound Active Modes	14
Color Calibration Settings	15
Custom Static Colors	15
Fixture Reset Functions	15
Custom Static Colors	16
Data Sync Feature	16
Fixture ID Settings	16
Fixture Information	16
DMX Value In-Depth Reference Guide	17
LED Pixel Group Configurations	18
DMX In-Depth Reference	19
5. Appendix	21
A Quick DMX Lesson	21
Dimensional Drawings	21
Keeping Your PixelStorm™ COB Mini As Good As New	22
Returns (Gasp!)	22
Shipping Issues	22
Tech Specs	23

1. GETTING STARTED

What's In The Box?

- 1 x PixelStorm™ COB Mini Professional LED Fixture
- An Ever-So-Handy Power Cord
- This Lovely User Manual

Getting It Out Of The Box

Congratulations on purchasing one way cool, way flexible, way original LED strip light! Now that you've got your PixelStorm™ COB Mini (*or hopefully, Minis!*), you should carefully unpack the box and check the contents to ensure that all parts are present and in good condition. If anything looks as if it has been damaged in transit, notify the shipper immediately and keep the packing material for inspection. Again, please save the carton and all packing materials. If a fixture must be returned to the factory, it is important that the fixture be returned in the original factory box and packing.

Powering Up!

All fixtures must be powered directly off a switched circuit and **cannot be run off a rheostat (variable resistor) or dimmer circuit, even if the rheostat or dimmer channel is used solely for a 0% to 100% switch.**

AC Voltage Switch - Not all fixtures have a voltage select switch, so please verify that the fixture you receive is suitable for your local power supply. See the label on the fixture or refer to the fixture's specifications chart for more information. A fixture's listed current rating is its average current draw under normal conditions. Check the fixture or device carefully to make sure that if a voltage selection switch exists that it is set to the correct line voltage you will use.

Warning! Verify that the voltage select switch on your unit matches the line voltage applied. Damage to your fixture may result if the line voltage applied does not match the voltage indicated on the voltage selector switch. All fixtures must be connected to circuits with a suitable Ground (Earthing).

Getting A Hold Of Us

If something is wrong, please just visit our website at www.blizzardlighting.com and open a support ticket. We'll be happy to help, honest.

Blizzard Lighting
N16 W23390 Stoneridge Dr. Suite E
Waukesha, WI 53188 USA
www.blizzardlighting.com
414-395-8365

Disclaimer: The information and specifications contained in this document are subject to change without notice. Blizzard Lighting™ assumes no responsibility or liability for any errors or omissions that may appear in this user manual. Blizzard Lighting™ reserves the right to update the existing document or to create a new document to correct any errors or omissions at any time. You can download the latest version of this document from www.blizzardlighting.com.

Author:	Date:	Last Edited:	Date:
J. Thomas	2/24/2015	J. Thomas	2/26/2015

SAFETY INSTRUCTIONS



Please read these instructions carefully. They include important information about the installation, usage and maintenance of this product.

- Please keep this User Guide for future use. If you sell the unit to someone else, be sure that they also receive this User Guide.
- ALWAYS make sure that you are connecting to the proper voltage, and that the line voltage you are connecting to is not higher than that stated on the decal or rear panel of the fixture.
- This product is intended for indoor use only.
- To prevent risk of fire or shock, do not expose fixture to rain or moisture.
- Make sure there are no flammable materials close to the unit while operating.
- The unit must be installed in a location with adequate ventilation, at least 20in (50cm) from adjacent surfaces. Be sure that no ventilation slots are blocked.
- ALWAYS disconnect from the power source before servicing or replacing fuse and be sure to replace with same fuse size and type.
- ALWAYS secure fixture using a safety chain. NEVER carry the fixture by its cord. Use its carrying handles.
- DO NOT operate at ambient temperatures higher than 104°F (40°C).
- In the event of a serious operating problem, stop using the unit immediately. NEVER try to repair the unit by yourself. Repairs carried out by unskilled people can lead to damage or malfunction. Please contact the nearest authorized technical assistance center. Always use the same type spare parts.
- NEVER connect the device to a dimmer pack.
- Make sure the power cord is never crimped or damaged.
- Never disconnect the power cord by pulling or tugging on the cord.
- Avoid direct eye exposure to the light source while it is on.

Caution! There are no user serviceable parts inside the unit. Do not open the housing or attempt any repairs yourself. In the unlikely event your unit may require service, please open a support ticket at www.blizzardlighting.com/tickets.

2. MEET THE PIXELSTORM™ COB MINI

CONTROL FEATURES

- 6x 25W 5-in-1 COB LEDs, 100,000 hours
- Built-in color and pixel chase macros via DMX
- Virtual color wheel effect
- 33 built-in automated programs + 2 sound active modes
- RGBAW color mixing ability in standalone mode
- 10 custom color, and 3 custom program banks
- Variable electronic dimmer & strobe
- Custom global color calibration settings
- Fixture ID addressing
- Beam Angle: 45 degree
- Easy to use LED control panel
- 5/6/11/18/23/30 or 38-channel DMX modes w/two different pixel group configurations in 18/23-channel modes

ADDITIONAL FEATURES

- Rugged and well-built (It hits the gym regularly)
- Super-quiet, variable speed internal fan cooling
- Dual mounting brackets with locking knobs for positioning flexibility
- Flicker-free constant-current LED driver
- 3-pin male input and 3-pin female output
- PowerCon™ compatible AC power In/Out connectors
- Can directly power the wiCICLE® wireless system via DMX

DMX Quick Reference (5/6/11/18/23/30/38-Channel Modes)

Ch.	11-Channel
1	Dimmer
2-6	Full Bar Color Mixing
7	Strobe
8	Effect
9	Speed
10	Virtual Color Wheel
11	Dimming Modes

Ch.	6-Channel
1	Dimmer
2-6	Full Bar RGBAW Mixing

Ch.	5-Channel
1-5	Full Bar RGBAW Mixing

Ch.	30-Channel
1-30	6 Pixel RGBAW Control

Ch.	18-Channel
1	Dimmer
2-11	2 Pixel Group Control
12	Strobe
13	Effect
14	Speed
15	Virtual Color Wheel
16	Dimming Modes
17	ID Function
18	ID Address

Ch.	23-Channel
1	Dimmer
2-16	3 Pixel Group Control
17	Strobe
18	Effect
19	Speed
20	Virtual Color Wheel
21	Dimming Modes
22	ID Function
23	ID Address

Ch.	38-Channel
1	Dimmer
2-31	6 Pixel Control
32	Strobe
33	Effect
34	Speed
35	Virtual Color Wheel
36	Dimming Modes
37	ID Function
38	ID Address

Figure 1: The PixelStorm™ COB Mini Pin-Up Picture

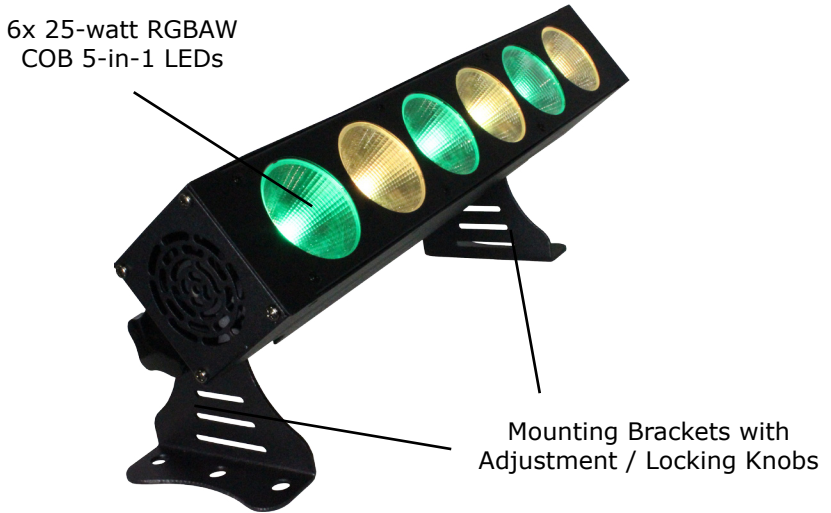
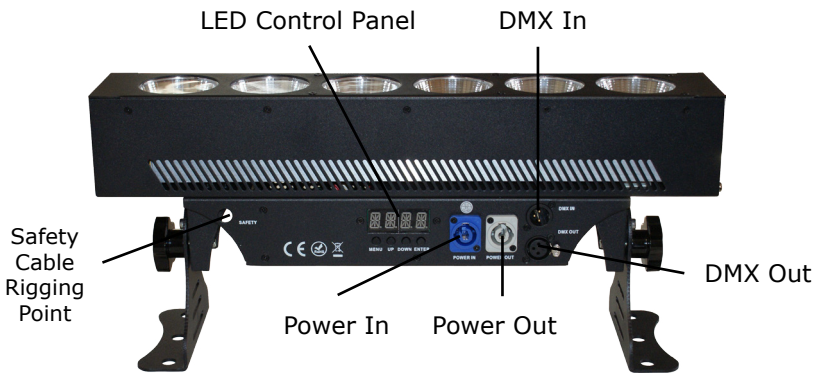

Figure 2: The Rear Connections



3. SETUP



Before replacing a fuse, disconnect power cord. ALWAYS replace with the same type and rating of fuse.

Fuse Replacement

CAUTION! The PixelStorm™ COB Mini utilizes a high-output switch-mode power supply with an internal fuse. Under normal operating conditions, the fuse should not require replacement. The fuse is field replaceable, however it is an advanced procedure suited to qualified individuals. Should your PixelStorm™ COB Mini fuse require replacement, please contact Blizzard Lighting for instructions, or to return your unit for service.

Connecting A Bunch of PixelStorm™ COB Mini Fixtures

You will need a serial data link to run light shows using a DMX-512 controller or to run shows on two or more fixtures set to sync in master/slave operating mode. The combined number of channels required by all the fixtures on a serial data link determines the number of fixtures the data link can support.

Fixtures on a serial data link must be daisy chained in one single line. Also, connecting more than 32 fixtures on one serial data link without the use of a DMX optically-isolated splitter may result in deterioration of the digital DMX signal.

The maximum recommended cable-run distance is 500 meters (1640 ft). The maximum recommended number of fixtures on a serial data link is 32 fixtures.

Data/DMX Cabling

To link fixtures together you'll need data cables. You should use data-grade cables that can carry a high quality signal and are less prone to electromagnetic interference.

For instance, Belden© 9841 meets the specifications for EIA RS-485 applications. Standard microphone cables will "probably" be OK, but note that they cannot transmit DMX data as reliably over long distances. In any event, the cable should have the following characteristics:

2-conductor twisted pair plus a shield
Maximum capacitance between conductors – 30 pF/ft.
Maximum capacitance between conductor & shield – 55 pF/ft.
Maximum resistance of 20 ohms / 1000 ft.
Nominal impedance 100 – 140 ohms

Cable Connectors

Cables must have a male XLR connector on one end and a female XLR connector on the other end. (Duh!)

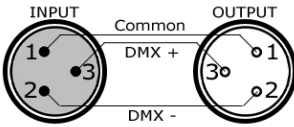

A Word on Termination: DMX is a resilient communication protocol, however errors still occasionally occur. Termination reduces signal errors, and therefore best practices include use of a terminator in all circumstances. If you are experiencing problems with erratic fixture behavior, especially over long signal cable runs, a terminator may help improve performance.

To build your own DMX Terminator:
Obtain a 120-ohm, 1/4-watt resistor, and wire it between pins 2 & 3 of the last fixture. They are also readily available from specialty retailers.

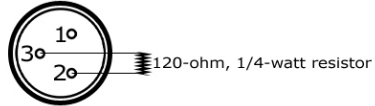

CAUTION: Do not allow contact between the common and the fixture's chassis ground. Grounding the common can cause a ground loop, and your fixture may perform erratically. Test cables with an ohm meter to verify correct polarity and to make sure the pins are not grounded or shorted to the shield or each other.

3-Pin??? 5-Pin??? Huh?!?

If you use a controller with a 5 pin DMX output connector, you will need to use a 5 pin to 3 pin adapter. They are widely available over the internet and from specialty retailers. If you'd like to build your own, the chart below details a proper cable conversion:

Conductor	3-Pin Female (Output)	5-Pin Male (Input)
Ground/Shield	Pin 1	Pin 1
DMX Data (-)	Pin 2	Pin 2
DMX Data (+)	Pin 3	Pin 3
Not Used.	No Connection.	No Connection.
Not Used.	No Connection.	No Connection.

Take It To The Next Level: Setting Up DMX Control

Step 1: Connect the male connector of the DMX cable to the female connector (output) on the controller.



Step 2: Connect the female connector of the DMX cable to the first fixture's male connector (input). *Note:* It doesn't matter which fixture address is the first one connected. We recommend connecting the fixtures in terms of their proximity to the controller, rather than connecting the lowest fixture number first, and so on.

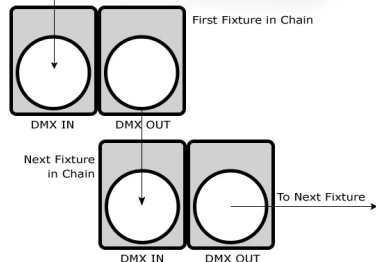

Step 3: Connect other fixtures in the chain from output to input as above. Place a DMX terminator on the output of the final fixture to ensure best communication.

Fixture Linking (Master/Slave Mode)

1. Connect the (male) 3 pin connector side of the DMX cable to the output (female) 3 pin connector of the first fixture.
2. Connect the end of the cable coming from the first fixture which will have a (female) 3 pin connector to the input connector of the next fixture consisting of a (male) 3 pin connector. Then, proceed to connect from the output as stated above to the input of the following fixture and so on.

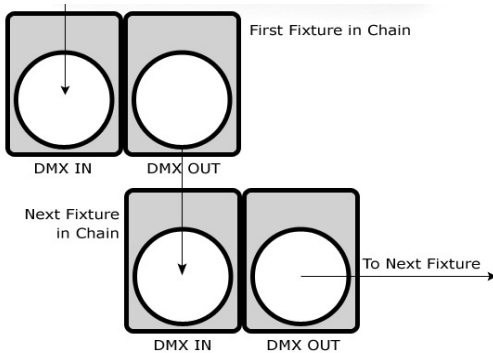

A quick note: Often, the setup for Master-Slave and Standalone operation requires that the first fixture in the chain be initialized for this purpose via either settings in the control panel or DIP-switches. Secondly, the fixtures that follow may also require a slave setting.

Check the **"Operating Adjustments"** section in this manual for complete instructions for this type of setup and configuration.

Mounting & Rigging

This fixture may be mounted in any SAFE position provided there is enough room for ventilation.

It is important never to obstruct the fan or vents pathway. Mount the fixture using a suitable "C" or "O" type clamp. The clamp should be rated to hold at least 10x the fixture's weight to ensure structural stability. Do not mount to surfaces with unknown strength, and ensure properly "rated" rigging is used when mounting fixtures overhead.

Adjust the angle of the fixture by loosening both knobs and tilting the fixture. After finding the desired position, retighten both knobs.

- When selecting installation location, take into consideration lamp replacement access (if applicable) and routine maintenance.
- Safety cables **MUST ALWAYS** be used.
- Never mount in places where the fixture will be exposed to rain, high humidity, extreme temperature changes or restricted ventilation.

USING THIS FIXTURE WITH THE wiCICLE® WIRELESS DMX SYSTEM

In addition to the unbridled thrill you already received the first time you plugged in your fixture, you'll be delighted to know that This fixture also works seamlessly with our wiCICLE® Wireless DMX system, **without additional power.**

- ONLY fixtures bearing this logo are certified for use with the wiCICLE® without external power.

- **Unauthorized modification and/or using the wiCICLE® with unapproved fixtures may cause damage to the wiCICLE® or fixture. UNDER NO CIRCUMSTANCES IS BLIZZARD LIGHTING RESPONSIBLE FOR ANY DAMAGE FROM SUCH OPERATION.**



- Fixtures bearing the above logo **MUST** only use cable and connectors which separate chassis/case ground from cable shielding. Cabling with the shield connected to the connector's case/chassis may cause malfunction and damage to the wiCICLE® or fixture.

- wiCICLE® transmitters have additional power requirements and therefore cannot be powered directly from the fixture. You will need to utilize the supplied AC/DC adaptor to drive wiCICLE® transmitters in your system.

Each wiCICLE® acts as both a transmitter and a receiver, depending on whether a DMX source is applied to the integral XLR connector. This is an extremely powerful feature of the system, however, it also requires 1 piece of due diligence, and that is the removal of extraneous DMX signals from your lighting rig BEFORE proceeding.

SO: BEFORE DOING ANYTHING ELSE, YOU SHOULD DISABLE ANY BUILT-IN PROGRAMS IN THE FIXTURES YOU WISH TO CONNECT AND/OR SET THEM AS SLAVES PRIOR TO RETURNING THEM TO DMX MODE (IF APPLICABLE). Most fixtures contain a built-in automatic, sound active or custom program which is designed to operate with the fixture NOT connected to a DMX chain.

Some of these programs will automatically run unless the fixture is set to slave mode. These fixtures typically sense DMX automatically and switch to DMX mode upon receiving DMX signal (our Pucks do that!)

If you plug a wiCICLE® "receiver" into an autosensing fixture set as a "master," chances are good that the wiCICLE® "receiver" will begin transmitting the master program. Most times, this is undesirable, and taking the two seconds to switch these programs off will solve a lot of ails.

Got that done? Good! Then let's proceed!

1. Plug the wiCICLE® Receiver into the "DMX IN" connector of the fixture and verify it is receiving power (the **STATUS LED** should illuminate.)
2. Connect the AC/DC adaptor to the wiCICLE® Transmitter and verify it is receiving power (the **STATUS LED** should illuminate.)
3. Press the **RECESSED SELECTOR BUTTON** on the Transmitter to select the operating channel group. (The system will store this setting for future use)

The 7-Color Status LED will change color to indicate the current channel group:

- GROUP 1: **RED**
- GROUP 2: **GREEN**
- GROUP 3: **YELLOW**
- GROUP 4: **BLUE**
- GROUP 5: **VIOLET**
- GROUP 6: **CYAN**
- GROUP 7: **WHITE**

NOTE: "GROUP" number also corresponds to the "GROUP" setting on our LightCaster™ wireless DMX Transceiver.

4. Follow the same procedure on the Receiver to select the channel group.
5. Once both the transmitter and receiver(s) are both set to the same channel group, connect the transmitter to the DMX controller or the DMX out of a fixture on your DMX chain.
6. Once a DMX signal is provided to the transmitter, the status LED will blink **RED** slowly until communication is established with the receiver. The status LED on the receiver(s) will flash **GREEN** slowly until communication is established.
7. Once the clearest channel is auto-selected, the status LEDs will blink quickly on both the transmitter and receiver. NOTE: The color of the LED DURING operation does not indicate channel group, instead it indicates whether the unit is transmitting or receiving. **That's It!**

4. OPERATING ADJUSTMENTS

The Control Panel

All the goodies and different modes possible with the PixelStorm™ COB Mini are accessed by using the control panel on the rear of the fixture. There are 4 control buttons below the LED display which allow you to navigate through the various control panel menus.

<MENU>

Is used to navigate to the previous higher-level menu item.

<UP>

Scrolls through menu items and numbers in ascending order.

<DOWN>

Scrolls through menu items and numbers in descending order.

<ENTER>

Is used to select and confirm/store the current selection.

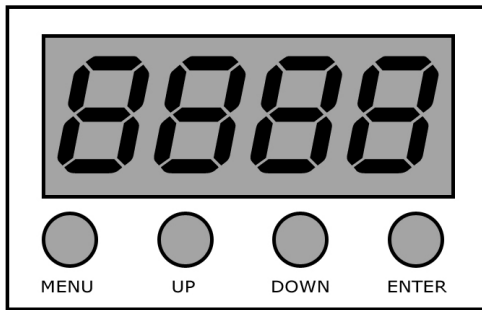

The control panel LED display shows the menu items you select from the menu map on page #12. When a menu function is selected, the display will show immediately the first available option for the selected menu function. To select a menu item, press **<ENTER>**.

Use the **<UP>** and **<DOWN>** buttons to navigate the menu options. Press the **<ENTER>** button to select the menu function currently displayed, or to enable a menu option. To return to the previous option or menu without changing the value, press the **<MENU>** button.

Control Panel Menu Structure

ADDR	001-512	To choose the DMX address			
STAT	R1	Red intensity - Group 1 (0% <--> 100%)			
	G1	Green intensity - Group 1 (0% <--> 100%)			
	B1	Blue intensity - Group 1 (0% <--> 100%)			
	A1	Amber intensity - Group 1 (0% <--> 100%)			
	W1	White intensity - Group 1 (0% <--> 100%)			
	R2	Red intensity - Group 2 (0% <--> 100%)			
	G2	Green intensity - Group 2 (0% <--> 100%)			
	B2	Blue intensity - Group 2 (0% <--> 100%)			
	A2	Amber intensity - Group 2 (0% <--> 100%)			
	W2	White intensity - Group 2 (0% <--> 100%)			
	R3	Red intensity - Group 3 (0% <--> 100%)			
	G3	Green intensity - Group 3 (0% <--> 100%)			
	B3	Blue intensity - Group 3 (0% <--> 100%)			
	A3	Amber intensity - Group 3 (0% <--> 100%)			
W3	White intensity - Group 3 (0% <--> 100%)				
	SHUT	Flash / strobe speed (0-255)			
SET	CAL	To set global intensity levels of each color + USE: YES/NO			
	CHMD	38CH	To run in 38-channel mode		
		30CH	To run in 30-channel mode		
		23CH	To run in 23-channel mode (LED Group 1 setting)		
		23CH.	To run in 23-channel mode (LED Group 2 setting)		
		18CH	To run in 18-channel mode (LED Group 1 setting)		
		18CH.	To run in 18-channel mode (LED Group 2 setting)		
		11CH	To run in 11-channel mode		
		6CH	To run in 6-channel mode		
	5CH	To run in 5-channel mode			
	DIM (dimming)	LIN	Linear dimming curve		
		SQR	Square law curve		
		ISQR	Inverse square law curve		
		SCUR	S-curve		
		LIN.	Linear dimming curve (smooth)		
		SQR.	Square law curve (smooth)		
		ISQR.	Inverse square law curve (smooth)		
	SCUR.	S-curve (smooth)			
	DISY (display)	ON	LED menu display is on continually		
		2MIN	LED menu display shuts off after 2 minutes of inactivity		
	FAN	<ENTER>	Fan speed (high/medium/low)		
CTST	CT01-CT10	<ENTER>	R/G/B/A/W adjustments for custom color banks 01-10		
AUTO	AT01-AT33	<ENTER>	Auto programs 1-33		
	ATSP (speed)	<ENTER>	Auto Speed		
	CHS1	<ENTER>	Custom program 1		
	CHS2	<ENTER>	Custom program 2		
	CHS3	<ENTER>	Custom program 3		
	SOU1	<ENTER>	Sound Active Mode 1 (color changing)		
	SOU2	<ENTER>	Sound Active Mode 2 (white strobe)		
PROG	CHS1-CHS3 Custom programs 1-3.	SC01-SC20 20 scenes for each custom program.	R1 (0-255)	B2 (0-255)	W3 (0-255)
			G1 (0-255)	A2 (0-255)	SHUT (strobe, 0-255)
			B1 (0-255)	W2 (0-255)	AUTO (None, AT01-AT33)
			A1 (0-255)	R3 (0-255)	ATSP (speed, 0-255)
			W1 (0-255)	G3 0-255)	TIME (duration, 0-255)
			R2 (0-255)	B3 (0-255)	WAIT (before fade, 0-255)
			G2 (0-255)	A3 (0-255)	USE (use scene, YES/NO)
INFO	SOFT	Vx.x	Software version information		
		POW	Current automated overheat protection level (100%/80%/50%)		
LOAD	ST L	Restore factory settings			
	PR L	Restore factory program settings			
SEND	YES/NO	Sync settings between fixtures via DMX			
ID	0-255	Fixture ID			

DMX Mode

Allows the unit to be controlled by any universal DMX controller.

Setting the DMX Address:

- 1.) The default mode for the fixture is DMX, which appears as **001** on the LED readout. To select a different DMX address, using the **<MENU>** button, select **ADDR**, then hit **<ENTER>**. Use the **<UP/DOWN>** buttons to select the correct address, then hit **<ENTER>** to confirm.

Setting the DMX Channel Mode:

- 1.) To select a DMX channel mode, press the **<MENU>** button, then use the **<UP/DOWN>** buttons until the display reads **SET** and press the **<ENTER>** button. Then use the **<UP/DOWN>** buttons until the display reaches **CHMD**, and press **<ENTER>**. Now press the **<UP/DOWN>** buttons again to highlight your desired DMX channel mode, and press the **<ENTER>** button to confirm.

Slave Mode:

- 1.) Daisy chain the fixtures DMX in/out, having the controller at the beginning of the line.
- 2.) There is nothing else to it! The first fixture in the DMX chain is the master fixture, and the following fixtures will follow the master.

Dimming Mode Settings:

Allows users to set the fixture to use 1 of 4 (x2) dimming curve settings for smoother (and slower) dimming capabilities. In the control panel menu, there are two settings for each curve that are distinguishable from one another by the trailing dot.

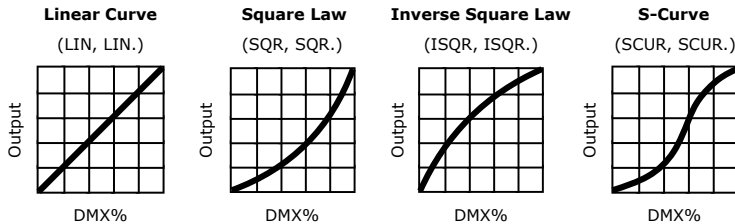

*The curve settings with the trailing dot adds a bit more delay to the curve for a smoother effect.

- 1.) Use the **<MENU>** and **<UP/DOWN>** buttons to navigate to **SET** and press **<ENTER>**, then **<UP/DOWN>** buttons again to scroll to **DIM**, and press the **<ENTER>** button.
- 2.) Now use the **<UP/DOWN>** buttons to highlight either **LIN** (Linear), **SQR** (Square), **ISQR** (Inverse Square), **SCUR** (S-Curve), **LIN.** (Smooth Linear), **SQR.** (Smooth Square), **ISQR.** (Smooth Inverse Square), or **SCUR.** (Smooth S-Curve), then hit **<ENTER>**.

LED Display and Fan Speed Setting:

- 1.) Use the **<MENU>** and **<UP/DOWN>** buttons to navigate to **SET** and press **<ENTER>**, then navigate to either **DISY** (display), or **FAN** (fan), and press the **<ENTER>** button.
- 2.) In **DISY**, you can set the LED menu display to be continually on, or shut off after 2 min of inactivity. In **FAN**, you can set the fan speed to run at high, medium, or low.

Custom Programs:

Allows users to create up to 3 customizable, 20 scene programs that are directly accessible via the control panel and also in DMX mode.

Creating A Custom Program:

- 1.) Use the <MENU> and <UP/DOWN> buttons to navigate to **PROG**, and press <ENTER>.
- 2.) Now use the <UP/DOWN> buttons to highlight your choice of either **CHS1**, **CHS2**, or **CHS3** and press <ENTER>.
- 3.) Start with editing scene 1 (**SC01**), customizing it to your liking by using the choices outlined in the table below. You can insert any of its 33 built-in auto programs (**AT01-AT33**), and adjust its speed (**ATSP 0-255**), and also set the duration (in seconds) before moving on to the next scene (**TIME 0-255**). Or, you can create a custom scene by color mixing any (or all) of the 3 pixel groups, then add in a fade in effect (**WAIT 0-255**), and/or strobe (**SHUT 0-255**). Finally, if you want to use this scene in your program, *be sure to enable it* (**USE: YES/NO**).
- 4.) Repeat the above process to create up to 20 scenes in each of the 3 customizable programs.

R1 (0-255) - Red Group 1 Intensity	B2 (0-255) - Blue Group 2 Intensity	W3 (0-255) - White Group 3 Intensity
G1 (0-255) - Green Group 1 Intensity	A2 (0-255) - Amber Group 2 Intensity	SHUT (0-255) - Strobe (slow - fast)
B1 (0-255) - Blue Group 1 Intensity	W2 (0-255) - White Group 2 Intensity	AUTO (AT01-AT33) - Auto Programs
A1 (0-255) - Amber Group 1 Intensity	R3 (0-255) - Red Group 3 Intensity	ATSP (0-255) - Auto Speed (fast - slow)
W1 (0-255) - White Group 1 Intensity	G3 (0-255) - Green Group 3 Intensity	TIME (0-255) - Scene Time (seconds)
R2 (0-255) - Red Group 2 Intensity	B3 (0-255) - Blue Group 3 Intensity	WAIT (0-255) - Fade In (fast - slow)
G2 (0-255) - Green Group 2 Intensity	A3 (0-255) - Amber Group 3 Intensity	USE (YES/NO) Use Scene in Program?

IMPORTANT: If USE is set to NO, or TIME is set to 0, the scene will not run!

Running A Custom Program:

- 1.) To view your newly created lighting masterpiece, use the <MENU> and <UP/DOWN> buttons to navigate to **AUTO**, and press <ENTER>.
- 2.) Use the <UP/DOWN> buttons to highlight your choice of either **CHS1**, **CHS2**, or **CHS3** and press <ENTER>. These are also directly accessible from the **Effect Channel** in DMX mode.

Auto, Speed, and Sound Active Modes:

Set single or Master/Slaved units to run in sound active or auto mode at user selectable speeds.

Sound Active Mode:

- 1.) Use the <MENU> and <UP/DOWN> buttons to navigate to **AUTO** and press <ENTER>, then with the <UP/DOWN> buttons navigate to **SOU1** (color change), or **SOU2** (white strobe only), and press the <ENTER> button.

Auto Mode:

- 1.) Use the <MENU> and <UP/DOWN> buttons to navigate to navigate to **AUTO**, and press the <ENTER> button.
- 2.) Now use the <UP/DOWN> buttons to highlight any program ranging from **AT01-AT33**, and press <ENTER>.

Auto Speed:

- 1.) Use the <MENU> and <UP/DOWN> buttons to navigate to **AUTO** and press <ENTER>, then with the <UP/DOWN> buttons navigate to **ATSP**, and press the <ENTER> button.
- 2.) Make a selection from **0-255**, and press <ENTER> to choose a speed (slow <-> fast).

Color Calibration Settings:

Allows the user to setup and save 1 customized R/G/B/A/W color balance setting and save it for future use. This custom setting is global, and it will effect all modes.

- 1.) Use the **<MENU>** and **<UP/DOWN>** buttons to navigate to **SET** and press **<ENTER>**, then on while **CAL**, push **<ENTER>** again.
- 2.) Use the **<UP/DOWN>** buttons to highlight either **R** (Red Level), **G** (Green Level), **B** (Blue Level), **A** (Amber Level), or **W** (White Level), then hit **<ENTER>**.
- 3.) Now using the **<UP/DOWN>** buttons, select the maximum level for each color between 000-255 (000=off), and hit **<ENTER>** to confirm your choice.
- 4.) You have now just setup and saved a custom global color calibration setting that you can use at you convenience. To use your custom setting now (or later), press the **<UP/DOWN>** buttons to reach **USE**, and press **<ENTER>**. Then choose either **YES** or **NO** and press **<ENTER>**. When you select **YES**, it enables this custom color calibration globally, and when choosing **NO** the fixture will continue to use the default color calibration settings. Your customized settings will be saved for later use even after powering off the fixture. It can be altered to your liking at any time. Just remember to return to this setting to either enable or disable it when needed.

Custom Static Colors:

Allows the user to create and save up to 10 custom static colors for use in standalone or DMX mode.

- 1.) Use the **<MENU>** and **<UP/DOWN>** buttons to navigate to **CTST** and press **<ENTER>**, then **<UP/DOWN>** buttons to select a color bank from **CT01-CT10**, and push **<ENTER>** to confirm your selection.
- 2.) Now use the **<UP/DOWN>** buttons to highlight either **R** (Red Level), **G** (Green Level), **B** (Blue Level), **A** (Amber Level), or **W** (White Level), then hit **<ENTER>**.
- 3.) Finally, using the **<UP/DOWN>** buttons, select the maximum level for each color between 000-255 (000=off), and hit **<ENTER>** to confirm your choice(s).
- 4.) These 10 custom colors can be accessed and edited to your liking at any time, and will be saved even after powering off the fixture.
- 5.) These static colors are directly accessible from the **Effect Channel** in DMX mode.

Fixture Reset Functions:

Allows users to reset the fixture to factory default settings, without loosing customized settings, or reset the custom programs exclusively.

- 1.) Use the **<MENU>** and **<UP/DOWN>** buttons to navigate to **LOAD** and press **<ENTER>**, then use the **<UP/DOWN>** buttons to highlight **ST L** or **PR L**, and press **<ENTER>**.
- 2.) Use the **<UP/DOWN>** buttons to highlight either **YES** or **NO**, then press **<ENTER>**.
- 3.) The **ST L** reset function will reset all default values *with the exception of* those in **ADDR** (address), **CTCT** (10 custom colors), and **PROG** (custom scenes and programs).
- 4.) The **PR L** reset function will only reset all customized program settings found in the **PROG** settings (custom scenes and programs).

Data Sync Feature:

Users can transfer their custom settings from one fixture to another via DMX.

- 1.) Disconnect fixtures from any DMX controllers, and link them together via DMX in/out.
- 2.) On the sending fixture (DMX out), navigate the main menu using the **<UP/DOWN>** buttons to reach **SEND**, and press the **<ENTER>** button.
- 3.) Select **YES**, and press the **<ENTER>** button to begin the transfer.
- 4.) Information for **ADDR** (address), **CAL** (global intensity), or **ID** (Fixture ID) will not be sent.
- 5.) After the data has been transferred, the receiving fixture will be automatically be reset.

Fixture ID Settings:

ID settings give you the ability to assign ID numbers to individual or groups of fixtures for quick and easy DMX control access. This is available in 68/28/23 and 18-channel DMX modes.

- 1.) Use the **<MENU>** and **<UP/DOWN>** buttons to navigate to **ID** and press **<ENTER>**.
- 2.) Now use the **<UP/DOWN>** buttons to select any ID value you would like to assign to this fixture, and press the **<ENTER>** button to save it.
- 3.) While using a DMX channel mode where fixture ID control available, you can now set the **ID Function Slider** to a value ranging from **010-020** for "1 ID control per each 1 digit", ex. 21 = ID21, 22=ID22, or you can set the **ID FUNCTION** slider to a value ranging from **021-030** for "1 ID control per each 10 digit" functionality, ex. 010 <--> 019 = ID1, etc.
- 4.) Now use the **ID Address Slider** on your controller to select the fixture ID number (or ID range) setup in steps 1 & 2, while keeping in mind the function method you selected in step 3.
- 5.) You should now have DMX control of any fixtures with this ID.

Fixture Information:

These are not editable features, they are for informational purposes only.

- 1.) Use the **<MENU>** and **<UP/DOWN>** buttons to navigate to **INFO** and press **<ENTER>**, then use the **<UP/DOWN>** buttons to highlight **SOFT** or **POW**, and press **<ENTER>**.
- 2.) The **SOFT** information simply displays the current software version installed on the fixture, and **POW** displays the fixtures current power level setting. Under normal conditions, it will be at 100%... but this fixture has built-in overheat protection that may automatically reduce the output level to 80%, or 50% in high temperature situations.

DMX Value In-Depth Reference Guide

Function	Value	What It Does
Dimmer	000 <--> 255	(0% <--> 100%)
Red Intensity	000 <--> 255	(0% <--> 100%)
Green Intensity	000 <--> 255	(0% <--> 100%)
Blue Intensity	000 <--> 255	(0% <--> 100%)
Amber Intensity	000 <--> 255	(0% <--> 100%)
White Intensity	000 <--> 255	(0% <--> 100%)
Strobe	000 <--> 005 006 <--> 020 021 <--> 060 061 <--> 100 101 <--> 140 141 <--> 180 181 <--> 220 221 <--> 255	No strobe Non-synchronous strobe (slow <--> fast) Synchronous strobe (slow <--> fast) Electronic sine wave (slow <--> fast) Random strobe (slow <--> fast) Opening pulse (slow <--> fast) Closing pulse (slow <--> fast) Electronic square wave (slow <--> fast)
Effect	000 <--> 005 006 <--> 010 011 <--> 015 016 <--> 020 021 <--> 025 026 <--> 030 031 <--> 035 036 <--> 040 041 <--> 045 046 <--> 050 051 <--> 055 056 <--> 060 061 <--> 065 066 <--> 070 071 <--> 075 076 <--> 080 081 <--> 085 086 <--> 090 091 <--> 095 096 <--> 100 101 <--> 105 106 <--> 110 111 <--> 115 116 <--> 120 121 <--> 125 126 <--> 130 131 <--> 135 136 <--> 140 141 <--> 145 146 <--> 150 151 <--> 155 156 <--> 160 161 <--> 165 166 <--> 170 171 <--> 175 176 <--> 180 181 <--> 185 186 <--> 190 191 <--> 195 196 <--> 200 201 <--> 205 206 <--> 210 211 <--> 215 216 <--> 220 221 <--> 225 226 <--> 230 231 <--> 235 236 <--> 240 241 <--> 245 246 <--> 255	No Function Custom color 1 (CT01 in menu settings) Custom color 2 (CT02 in menu settings) Custom color 3 (CT03 in menu settings) Custom color 4 (CT04 in menu settings) Custom color 5 (CT05 in menu settings) Custom color 6 (CT06 in menu settings) Custom color 7 (CT07 in menu settings) Custom color 8 (CT08 in menu settings) Custom color 9 (CT09 in menu settings) Custom color 10 (CT10 in menu settings) Auto 1 - R, G, B, A, W, RG, RB, GB, AW, RGBA, RGBW, RGBAW Auto 2 - R↑, R↓, G↑, G↓, B↑, B↓, A↑, A↓, W↑, W↓ Auto 3 - RG↑, RG↓, RB↑, RB↓, BG↑, BG↓ Auto 4 - RGBW↑, RGBW↓ Auto 5 - B, BG↑, BG, B↓G, G, GR↑, GR, G↓R, R, RB↑, RB, R↓B Auto 6 - 1 pixel chase, color change & repeat Auto 7 - 2 pixel amber, step running Auto 8 - 3 pixel orange, running with fade Auto 9 - 3 pixel pink, step running Auto 10 - 2 pixel red, running on green Auto 11 - 2 pixel green, running on blue Auto 12 - 2 pixel yellow, running on pink Auto 13 - 1 pixel red, step running Auto 14 - 1 pixel yellow, step running Auto 15 - 3 pixel yellow, running with fade Auto 16 - 3 pixel pink, running with fade Auto 17 - Yellow pixel from 1 to 6 then dark Auto 18 - Blue pixel from 1 to 6 then dark Auto 19 - Each pixel color change R/G/B/Y/P/C Auto 20 - Inverse direction auto 6 Auto 21 - Inverse direction auto 7 Auto 22 - 3 pixel white, running with fade Auto 23 - 3 pixel cyan, step running Auto 24 - Inverse direction auto 10 Auto 25 - Inverse direction auto 11 Auto 26 - Inverse direction auto 12 Auto 27 - Inverse direction auto 13 Auto 28 - Inverse direction auto 14 Auto 29 - Inverse direction auto 15 Auto 30 - Inverse direction auto 16 Auto 31 - Inverse direction auto 17 Auto 32 - Inverse direction auto 18 Auto 33 - All pixel rainbow effect Custom program 1 (CH01 in menu settings) Custom program 2 (CH02 in menu settings) Custom program 3 (CH03 in menu settings) Sound active mode 1 (color change) Sound active mode 2 (white strobe) No Function

DMX Value In-Depth Reference Guide (continued)

Function	Value	What It Does
Speed	000 <--> 255	(fast <--> slow)
Virtual Color Wheel	000 <--> 010 011 012 <--> 050 051 052 <--> 090 091 092 <--> 130 131 132 <--> 170 171 172 <--> 210 211 212 <--> 250 251 <--> 255	No Function Blue Blue (+ green) Teal Teal (- blue) Green Green (+ red) Yellow Yellow (- green) Red Red (+ blue) Magenta Magenta (- red) Blue
Dimming Mode	000 <--> 010 011 <--> 020 021 <--> 030 031 <--> 040 041 <--> 050 051 <--> 060 061 <--> 070 071 <--> 080 081 <--> 090 091 <--> 255	Default (as set in the LED menu) Linear curve Square law curve Inverse square law curve S-curve Linear curve (smooth) Square law curve (smooth) Inverse square law curve (smooth) S-curve (smooth) Default (as set in the LED menu)
ID Function	000 <--> 010 010 <--> 020 021 <--> 030 031 <--> 255	No Function 1 ID per each 1, ex. 021 = ID21, 022 = ID22 1 ID per each 10, ex. 010 <--> 019 = ID1 No function
ID Address	000 <--> 255	Control fixture(s) ID number 0-255

LED Pixel Group Configurations

Below are illustrations of the fixtures 6 pixel group configurations. Note that there are 2 different LED groups for 18ch and 23ch modes, that are distinguishable from each other by the trailing dot displayed on the LED control panel.

38ch/30ch

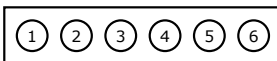

23ch (mode 1)

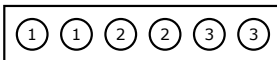

23ch. (mode 2)

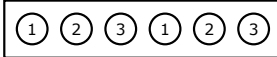

18ch (mode 1)

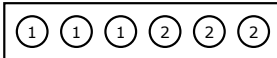

18ch. (mode 2)

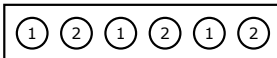

11ch/6ch/5ch

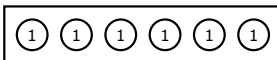

DMX In-Depth Reference: 38-Channel Mode

Channel	Name	Channel	Name
1	Dimmer	20	Amber 4
2	Red 1	21	White 4
3	Green 1	22	Red 5
4	Blue 1	23	Green 5
5	Amber 1	24	Blue 5
6	White 1	25	Amber 5
7	Red 2	26	White 5
8	Green 2	27	Red 6
9	Blue 2	28	Green 6
10	Amber 2	29	Blue 6
11	White 2	30	Amber 6
12	Red 3	31	White 6
13	Green 3	32	Strobe
14	Blue 3	33	Effect
15	Amber 3	34	Speed
16	White 3	35	Virtual Color Wheel
17	Red 4	36	Dimming Mode
18	Green 4	37	ID Function
19	Blue 4	38	ID Address

DMX In-Depth Reference: 30-Channel Mode

Channel	Name	Channel	Name
1	Red 1	16	Red 4
2	Green 1	17	Green 4
3	Blue 1	18	Blue 4
4	Amber 1	19	Amber 4
5	White 1	20	White 4
6	Red 2	21	Red 5
7	Green 2	22	Green 5
8	Blue 2	23	Blue 5
9	Amber 2	24	Amber 5
10	White 2	25	White 5
11	Red 3	26	Red 6
12	Green 3	27	Green 6
13	Blue 3	28	Blue 6
14	Amber 3	29	Amber 6
15	White 3	30	White 6

DMX In-Depth Reference: 23-Channel Mode

Ch.	Name	Ch.	Name	Ch.	Name	Ch.	Name
1	Dimmer	7	Red 2	13	Green 3	19	Speed
2	Red 1	8	Green 2	14	Blue 3	20	Virtual Color Wheel
3	Green 1	9	Blue 2	15	Amber 3	21	Dimming Mode
4	Blue 1	10	Amber 2	16	White 3	22	ID Function
5	Amber 1	11	White 2	17	Strobe	23	ID Address
6	White 1	12	Red 3	18	Effect		

DMX In-Depth Reference: 18-Channel Mode

Ch.	Name	Ch.	Name	Ch.	Name	Ch.	Name
1	Dimmer	6	White 1	11	White 2	16	Dimming Mode
2	Red 1	7	Red 2	12	Strobe	17	ID Function
3	Green 1	8	Green 2	13	Effect	18	ID Address
4	Blue 1	9	Blue 2	14	Speed		
5	Amber 1	10	Amber 2	15	Virtual Color Wheel		

DMX In-Depth Reference: 11-Channel Mode

Ch.	Name	Ch.	Name	Ch.	Name	Ch.	Name
1	Dimmer	4	Blue 1	7	Strobe	10	Virtual Color Wheel
2	Red 1	5	Amber 1	8	Effect	11	Dimming Mode
3	Green 1	6	White 1	9	Speed		

DMX In-Depth Reference: 6-Channel Mode

Ch.	Name	Ch.	Name	Ch.	Name
1	Dimmer	3	Green 1	5	Amber 1
2	Red 1	4	Blue 1	6	White 1

DMX In-Depth Reference: 5-channel Mode

Ch.	Name	Ch.	Name	Ch.	Name
1	Red 1	3	Blue 1	5	White 1
2	Green 1	4	Amber 1		

5. APPENDIX

A Quick Lesson On DMX

DMX (aka DMX-512) was created in 1986 by the United States Institute for Theatre Technology (USITT) as a standardized method for connecting lighting consoles to lighting dimmer modules. It was revised in 1990 and again in 2000 to allow more flexibility. The Entertainment Services and Technology Association (ESTA) has since assumed control over the DMX512 standard. It has also been approved and recognized for ANSI standard classification.

DMX covers (and is an abbreviation for) Digital MultipleXed signals. It is the most common communications standard used by lighting and related stage equipment.

DMX provides up to 512 control "channels" per data link. Each of these channels was originally intended to control lamp dimmer levels. You can think of it as 512 faders on a lighting console, connected to 512 light bulbs. Each slider's position is sent over the data link as an 8-bit number having a value between 0 and 255. The value 0 corresponds to the light bulb being completely off while 255 corresponds to the light bulb being fully on.

DMX is connected using a daisy-chain configuration where the source connects to the input of the first device, the output of the first device connects to the input of the next device, and so on. The standard allows for up to 32 devices on a single DMX link.

Each receiving device typically has a means for setting the "starting channel number" that it will respond to. For example, if two 6-channel fixtures are used, the first fixture might be set to start at channel 1 so it would respond to DMX channels 1 through 6, and the next fixture would be set to start at channel 7 so it would respond to channels 7 through 12.

The greatest strength of the DMX communications protocol is that it is very simple and robust. It involves transmitting a reset condition (indicating the start of a new "packet"), a start code, and up to 512 bytes of data. Data packets are transmitted continuously. As soon as one packet is finished, another can begin with no delay if desired (usually another follows within 1 ms). If nothing is changing (i.e. no lamp levels change) the same data will be sent out over and over again. This is a great feature of DMX -- if for some reason the data is not interpreted the first time around, it will be re-sent shortly.

Not all 512 channels need to be output per packet, and in fact, it is very uncommon to find all 512 used. The fewer channels are used, the higher the "refresh" rate. It is possible to get DMX refreshes at around 1000 times per second if only 24 channels are being transmitted. If all 512 channels are being transmitted, the refresh rate is around 44 times per second.

Dimensional Drawings

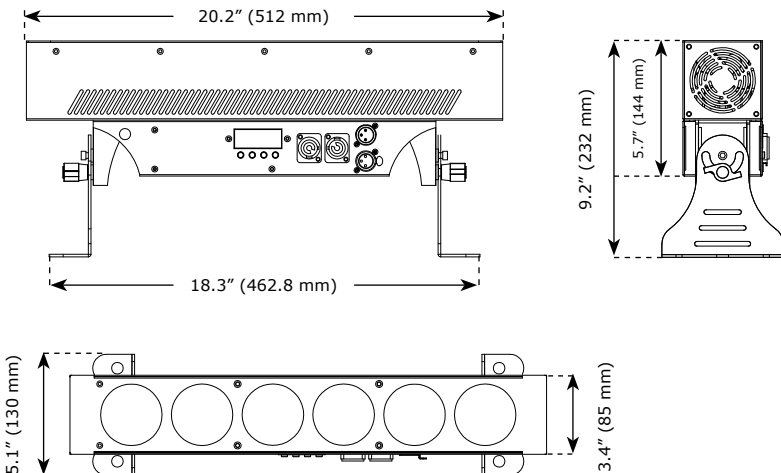

Keeping Your PixelStorm™ COB Mini As Good As New

The fixture you've received is a rugged, tough piece of pro lighting equipment, and as long as you take care of it, it will take care of you. That said, like anything, you'll need to take care of it if you want it to operate as designed. You should absolutely keep the fixture clean, especially if you are using it in an environment with a lot of dust, fog, haze, wild animals, wild teenagers or spilled drinks.

Cleaning the optics routinely with a suitable glass cleaner will greatly improve the quality of light output. Keeping the fans free of dust and debris will keep the fixture running cool and prevent damage from overheating.

In transit, keep the fixtures in cases. You wouldn't throw a prized guitar, drumset, or other piece of expensive gear into a gear trailer without a case, and similarly, you shouldn't even think about doing it with your shiny new light fixtures.

Common sense and taking care of your fixtures will be the single biggest thing you can do to keep them running at peak performance and let you worry about designing a great light show, putting on a great concert, or maximizing your client's satisfaction and "wow factor." That's what it's all about, after all!

Returns (Gasp!)

We've taken a lot of precautions to make sure you never even have to worry about sending a defective unit back, or sending a unit in for service. But, like any complex piece of equipment designed and built by humans, once in a while, something doesn't go as planned. If you find yourself with a fixture that isn't behaving like a good little fixture should, you'll need to obtain a Return Authorization (RA).

Don't worry, this is easy. Just go to our website and open a support ticket at www.blizzardlighting.com/tickets, and we'll issue you an RA. Then, you'll need to send the unit to us using a trackable, pre-paid freight method. We suggest using USPS Priority or UPS. Make sure you carefully pack the fixture for transit, and whenever possible, use the original box & packing for shipping.

When returning your fixture for service, be sure to include the following:

- 1.) Your contact information (Name, Address, Phone Number, Email address).
- 2.) The RA# issued to you
- 3.) A brief description of the problem/symptoms.

We will, at our discretion, repair or replace the fixture. Please remember that any shipping damage which occurs in transit to us is the customer's responsibility, so pack it well!

Shipping Issues

Damage incurred in shipping is the responsibility of the shipper, and must be reported to the carrier immediately upon receipt of the items. Claims must be made within seven (7) days of receipt.

DISCLAIMER:

The power connector fitted to the fixture and fixture cord are designed for compatibility with products manufactured by Neutrik AG, Neutrik USA and their related entities, however they are not manufactured by, affiliated with or endorsed by Neutrik AG, Neutrik USA, or any related entity. Neutrik® and power-CON® are registered trademarks of Neutrik AG.

Troubleshooting

Symptom	Solution
Fixture Auto-Shut Off	Check the fan in the fixture. If it is stopped or moving slower than normal, the unit may have shut itself off due to high heat. This is to protect the fixture from overheating.
Beam is Dim	Check optical system and clean excess dust/grime.
No Light Output	Check to ensure fixture is operating under correct mode, IE sound active/ auto/DMX/Etc., if applicable.
Chase Speed Too Fast/Slow	Check to ensure proper setup of speed adjustment.
No Power	Check fuse, AC cord and circuit for malfunction.
Slow Movement	Verify that 220V/110V switch is in the correct position, if applicable. Also check that speed channels are set appropriately.
No Response to Audio	Verify that the fixture is in "Sound Active" mode.

If your problem persists or isn't listed, please open a support ticket online at: www.blizzardlighting.com/tickets.

Tech Specs!

Weight & Dimensions							
Width	Fixture: 20.2" (512 mm), 18.3" (462.8 mm)						
Depth	Fixture: 3.4" (85 mm), Bracket: 5.1" (130 mm)						
Height	9.2" (232 mm)						
Weight	11.3 lbs (5.1 kg)						
Power							
Operating Voltage	100-264VAC, 50-60 Hertz						
Power Consumption	172W, 2.11A, pf: .66						
Light Source							
LED	12x 25W 5-in-1 COB LEDs 100,000 hours.						
Optical							
Beam Angle	45 degree beam						
Luminous Intensity	Lux/m	Red	Green	Blue	Amber	White	All
	1m	4420	5573	2148	2299	4951	16,843
	2m	1635	2774	826	815	2048	5,966
	3m	846	1340	390	370	961	3,689
	4m	536	806	232	212	544	2,177
5m	362	534	174	135	349	1,415	
Thermal							
Max. Operating Temp.	104 degrees F (40 degrees C) ambient						
Control							
Protocol	USITT DMX-512						
DMX Channels	5/6/11/18/23/30 or 38-channel DMX modes						
Input/Output	3-pin XLR Male/Female						
Other Operating Modes	Standalone, Master/Slave, Sound Active, Color Preset						
Other Information							
Hunchbacks hate backpacks. They prefer messenger bags.							
Warranty	2-year limited warranty, does not cover malfunction caused by damage to LEDs.						

Photometric Data: 45° Beam Angle LUX (Full RGBAW)

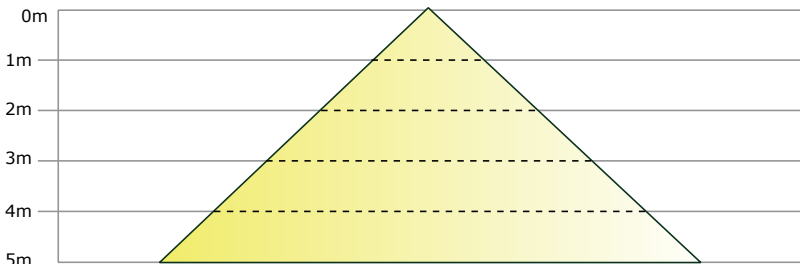

16,843 @ 1m	5,966 @ 2m	3,689 @ 3m	2,177 @ 4m	1,415 @ 5m
-------------	------------	------------	------------	------------



**Enjoy your product!
Our sincerest thanks for your purchase!
--The team @ Blizzard Lighting**