

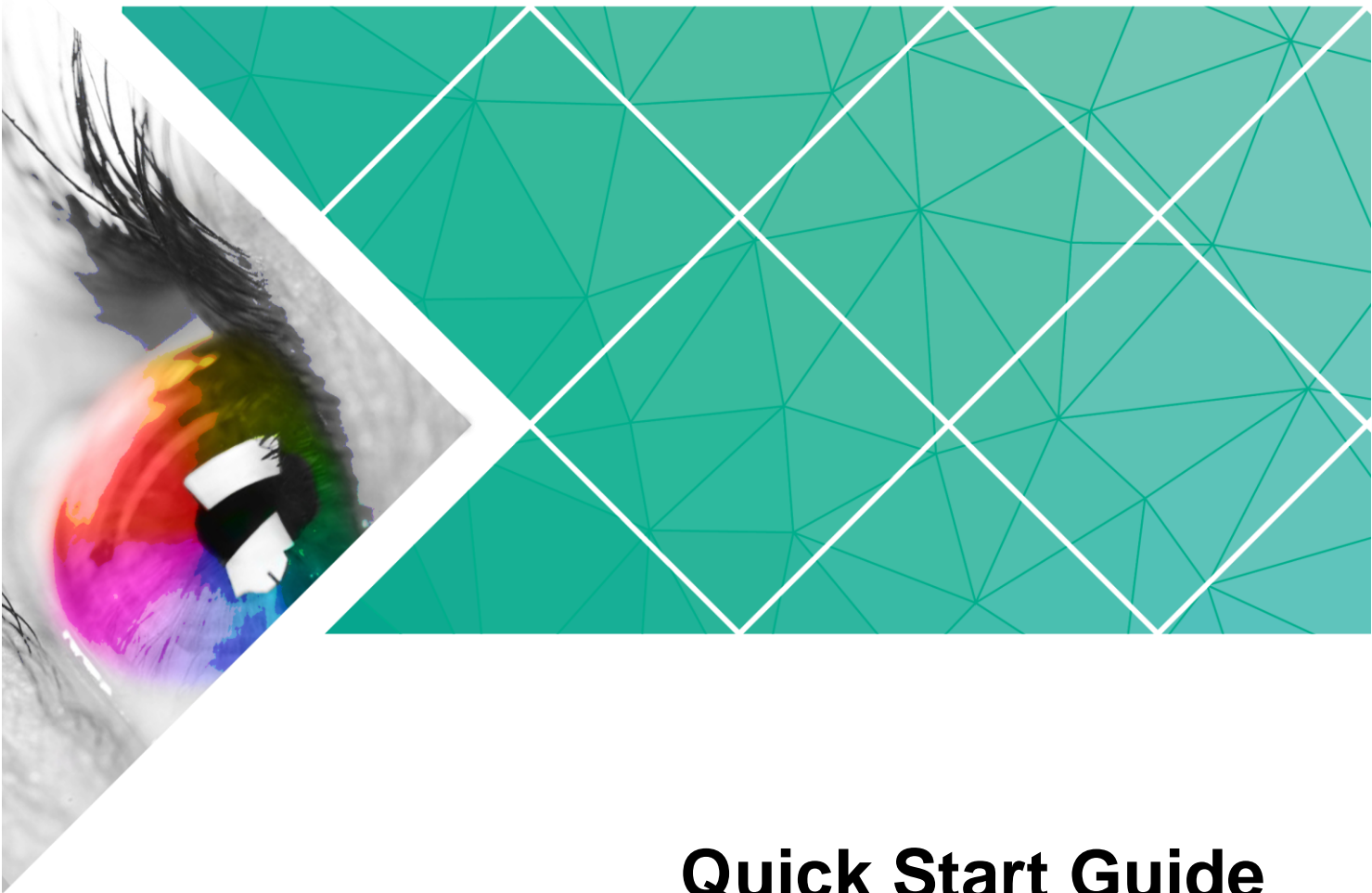

# Taurus Series

## Multimedia Players



## Quick Start Guide

---

Version: V1.0.0

Doc. ID: NS120100144

---

# Change History

---

Version	Release Date	Description
V1.0.0	2017-07-20	First release.

---

# Table of Contents

---

<b>Change History .....</b>	<b>i</b>
<b>Table of Contents.....</b>	<b>i</b>
<b>1 Overview.....</b>	<b>1</b>
1.1 Scenario.....	1
1.2 Procedures .....	1
<b>2 Preparation.....</b>	<b>2</b>
2.1 Getting and Installing Software.....	2
2.2 Getting Documents .....	3
2.3 Getting Required Account Information .....	3
<b>3 Taurus Connections .....</b>	<b>4</b>
3.1 Connecting via Ethernet Cable .....	4
3.2 Connecting via Local Area Network (LAN) .....	4
3.3 Connecting via Wi-Fi.....	5
3.3.1 Wi-Fi AP Mode.....	5
3.3.2 WiFi Sta Mode .....	6
3.3.3 WiFi AP+Sta Mode .....	6
<b>4 Receiving Card Parameter Configuration.....</b>	<b>8</b>
4.1 Loading Configuration File or Configuring the Parameters Manually Through NovaLCT-Taurus .....	8
4.2 Loading the Configuration File Through ViPlex Handy .....	9
<b>5 Screen Configuration .....</b>	<b>10</b>
5.1 Configuring a Screen Through ViPlex Handy.....	10
<b>6 General Operations.....</b>	<b>11</b>
6.1 Taurus Login with ViPlex Handy (Android and iOS).....	11
6.2 Taurus Login with ViPlex Express (Windows).....	11

# 1 Overview

## 1.1 Scenario

This document introduces a quick way to use Taurus series multimedia players and provides instructions for the first-timer.

## 1.2 Procedures

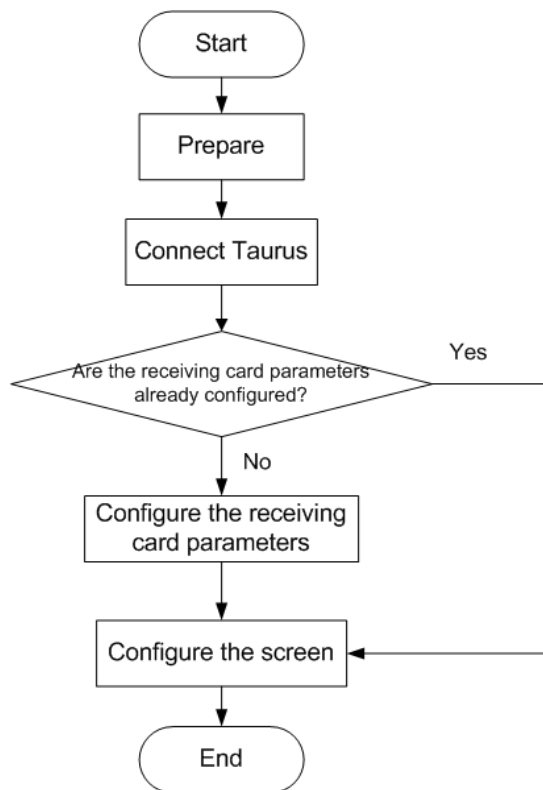

# 2 Preparation

## 2.1 Getting and Installing Software

Item	Description	How to get	How to install
ViPlex Handy	It is a LAN-based display management software, including the one applicable to Android and iOS operating systems, is mainly used for display management as well as solution editing and publishing.	Scan the following QR code to download and install the APP.  Use the App Store on your iPhone to get ViPlex Handy for iOS.	Software installation is the same as other applications.
ViPlex Express	It is a LAN-based display management software applicable to the Windows operating system, and is mainly used for display management as well as solution editing and publishing.	Visit <a href="http://www.novastar.tech">www.novastar.tech</a> , download and install the required software.	
NovaLCT-Taurus	Screen configuration software, which only supports Windows and is mainly used for adjusting screens to the optimal display status.	Visit <a href="http://www.novastar.tech">www.novastar.tech</a> , download and install the required software.	

## 2.2 Getting Documents

Item	Description	How to get
<i>Taurus Series Multimedia Players Product Description-V1.0.0</i>	Describing application scenarios, features, safety instructions, hardware structure, software structure and specifications of Taurus series products.	Visit <a href="http://www.novastar.tech">www.novastar.tech</a> to download the required documents.

## 2.3 Getting Required Account Information

Item	Account Name	Default Password
Connect Taurus WiFi AP	AP+ <i>last 8 digits of the SN</i> , For example: AP10000033	12345678
Log into the Taurus	admin	123456

# 3 Taurus Connections

In this chapter, the picture of T6 is taken as an example to introduce the Taurus series products.

## 3.1 Connecting via Ethernet Cable

### Network Diagram

Users can access the Taurus directly when it is connected via the Ethernet cable.



### Configuration

Step 1 Refer to “[6 General Operations](#)” to log in to the Taurus.

Step 2 Turn off DHCP and set static IP address for the Taurus.

- ViPlex Handy: Select **Network Setting, Wired Network Setting** in the **Screen management** page.
- ViPlex Express: Select **Screen Control, Network configuration**.

## 3.2 Connecting via Local Area Network (LAN)

### Network Diagram

Users can access the Taurus through LAN when it is connected via LAN.

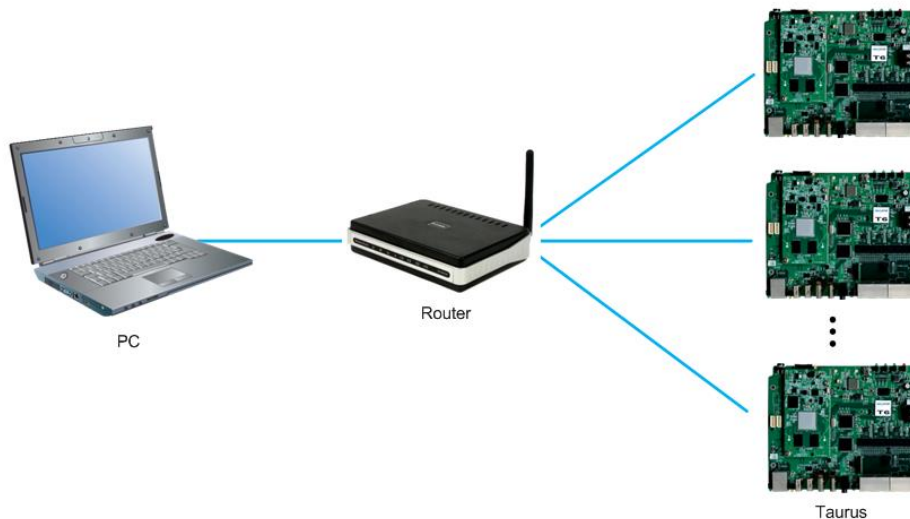

### Configuration

No need for configuration.

## 3.3 Connecting via Wi-Fi

The Taurus series products have dual WiFi function which can provide Wi-Fi hotspot as well as serve as WiFi Station at the same time.

### 3.3.1 Wi-Fi AP Mode

#### Network Diagram

Users can access the Taurus directly when it is connected via WiFi AP.

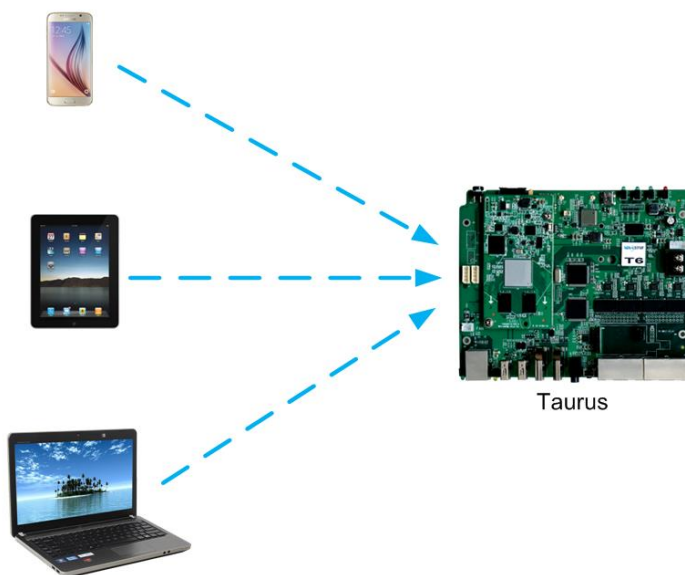



## Configuration

No need for configuration. Please connect the WiFi AP of the Taurus. SSID is “AP + last 8 digits of the SN”, for example, “AP10000033”.

### 3.3.2 WiFi Sta Mode

#### Network Diagram

Users can access Taurus through external router when it is connected via WiFi Sta.



## Configuration

Step 1 Refer to “[6 General Operations](#)” to log in to the Taurus.

Step 2 Turn on Wi-Fi Sta mode. Click the Wi-Fi name of the external router and then enter the password of the Wi-Fi.

- ViPlex Handy: Select **Network Setting, WiFi Setting** in the **Screen management** page.
- ViPlex Express: Select **Screen Control, Network configuration**.

### 3.3.3 WiFi AP+Sta Mode

#### Network Diagram

By using WiFi AP+Sta connection, users can directly access the Taurus or access the Internet through bridging connection.

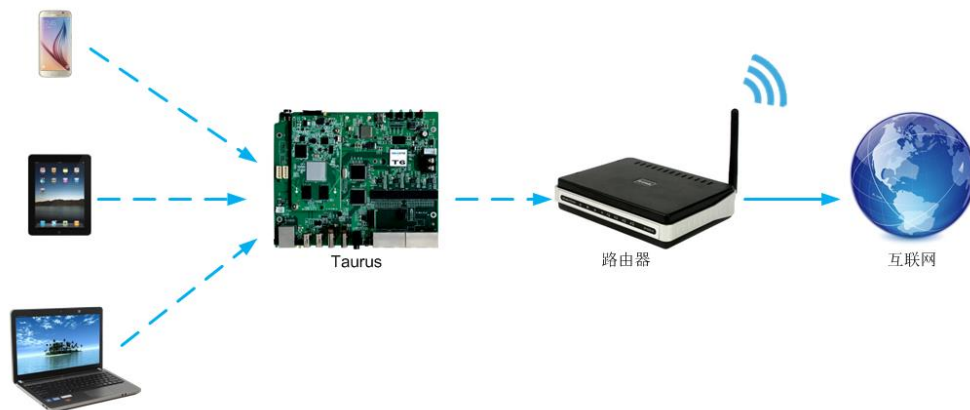

## Configuration

Step 1 Refer to “[6 General Operations](#)” to log in to the Taurus.

Step 2 Turn on Wi-Fi Sta mode. Click the Wi-Fi name of the external router and then enter the password of the Wi-Fi.

- ViPlex Handy: Select **Network Setting, WiFi Setting** in the **Screen management** page.
- ViPlex Express: Select **Screen Control, Network configuration**.

## Related Information

The Taurus can be connected to the Internet through following three ways. The priority order of the three ways is from high to low.

- Wired network
- WiFi Sta
- 4G network

Models of the Taurus must have 4G module while using 4G network. Users can enter following relevant menus to turn on the mobile network:

- ViPlex Handy: Select **Network Setting, Mobile Data Setting** in the **Screen management** page.
- ViPlex Express: Select **Screen Control, Network configuration**.

# 4 Receiving Card Parameter Configuration

If receiving card parameters are already configured, please skip this chapter and perform the operations in “5 Screen Configuration”.

## 4.1 Loading Configuration File or Configuring the Parameters Manually Through NovaLCT-Taurus

Step 1 Start NovaLCT-Taurus.

Step 2 Select **System, Search All Display**.

System will display the screen information list.

Step 3 Click screen information and click **Connect System**.

The gray button on the page will become normal.

Step 4 Select **User, Advanced login**.

Step 5 Enter password and click **Login**.

Default password is “admin”.

Step 6 Click  to enter the **Screen Config** page.

Step 7 Confirm whether the local PC has the required receiving card configuration file.

- Yes. Please perform **Load Configuration File**.
- No. Please perform **Manual Configuration**.

### Loading Configuration File

Step 1 Select **Cascading scan board** and **Load Configuration File**. Click **Browse** to choose a configuration file from the local PC.

Step 2 Click **Next** to load the configuration file.

### Manual Configuration

Step 1 Select **Cascading scan board** and click **Next**.

Step 2 Configure receiving card parameters based on actual conditions.

- Step 3 Click **Send To HW**.
- Step 4 Set parameters based on actual conditions and click **Send**.
- Step 5 Adjust parameters until the screen displays normally and then click **Save to Screen**.
- Step 6 (Optional) Click **Save Config File** to back up the receiving card configuration file to the local PC.

## 4.2 Loading the Configuration File Through ViPlex Handy

- Step 1 Save the receiving card configuration file to mobile phone.
- Step 2 Refer to “[6 General Operations](#)” to log in to the Taurus.
- Step 3 Click screen name to enter the **Screen management** page.
- Step 4 Select **Screen Setting, Receiving card configuration** to enter the **Receiving card configuration** page.
- Step 5 Select the receiving card configuration file and click **Send**.

# 5 Screen Configuration

---

## 5.1 Configuring a Screen Through ViPlex Handy

- Step 1 Refer to “[6 General Operations](#)” to log in to the Taurus.
- Step 2 Click screen name to enter the **Screen management** page.
- Step 3 Select **Screen Setting, Screen configuration** to enter the **Screen configuration** page.
- Step 4 Configure screen information based on actual conditions and click **OK**.

---

# 6 General Operations

---

## 6.1 Taurus Login with ViPlex Handy (Android and iOS)

### Before You Begin

- Acquire the SSID and password of Wi-Fi AP of Taurus series products. SSID is default to be composed of AP and the last 8 numbers of SN, and the password is default as “**12345678**”.
- Acquire the login password of user “admin” of which the default password is “**123456**”.



### Operating Procedures

ViPlex Handy can connect numerous Taurus series products.

Step 1 Connect Wi-Fi AP of the Taurus series products.

Step 2 Start ViPlex Handy.

System can automatically detect the Taurus series products and refresh **Screen list**. Users can also slide down **Screen list** to manually refresh the list.

- : denotes that Taurus is online and you can log into it.
- : denotes that Taurus is offline and you cannot log into it.
- : denotes that Taurus login is successful.

Step 3 Click **Connect** next to the screen name.

Step 4 Enter the user name and password and click **Login**.

## 6.2 Taurus Login with ViPlex Express (Windows)

### Before You Begin

- Acquire the SSID and password of Wi-Fi AP of Taurus series products. SSID is default to be composed of AP and the last 8 numbers of SN, and the password is default as “**12345678**”.
- Acquire the login password of user “admin” of which the default password is “**123456**”.



## Operating Procedures

ViPlex Express can connect numerous Taurus series products.

Step 1 Connect Wi-Fi AP of the Taurus series products.

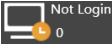

Step 2 Start the ViPlex Express.

Step 3 Click **Refresh** and the screen list will be displayed on the page.

- : denotes that Taurus is online and you can log into it.
- : denotes that Taurus is offline and you cannot log into it.
- : denotes that Taurus login is successful.

After the Taurus is found by ViPlex Express, the ViPlex express will try to log into to the Taurus with the default account or the account used for last login.

Step 4 Taurus login is successful or not.

- Yes.  appears and no further operation is required.
- No.  appears and then perform Step 5.

Step 5 Click **Connect** on the right of the screen information.

Step 6 Enter the username and password, and click **OK**.

# Taurus Series

## Multimedia Players



## Application Solution

---

Version: V1.0.0

Document Number: NS120100150



---

## Change History

---

Version	Release Date	Description
V1.0.0	2017-07-20	The first version.

---

# Table of Contents

---

<b>Change History</b> .....	<b>i</b>
<b>Table of Contents</b> .....	<b>ii</b>
<b>1 Overview</b> .....	<b>1</b>
1.1 About This Solution.....	1
1.2 Characteristics of the Application Solution .....	1
1.2.1 Synchronous Playing.....	1
1.2.2 Smart Brightness Adjustment .....	2
1.2.3 4G Module .....	2
1.2.4 Cluster Management .....	3
1.3 Software Acquiring Method .....	3
<b>2 AD Player and Mirror Screen Solution</b> .....	<b>5</b>
2.1 Overview.....	5
2.2 Single Application .....	7
2.2.1 Networking Diagram .....	7
2.2.2 Required Software .....	7
2.2.3 Relevant Configurations .....	7
2.3 Cluster Application.....	8
2.3.1 Networking Diagram .....	8
2.3.2 Required Software .....	8
2.3.3 Required Hardware Devices.....	8
2.3.4 Relevant Configurations .....	9
2.4 Splicing .....	12
2.4.1 Networking Diagram .....	12
2.4.2 Required Software .....	13
2.4.3 Relevant Configuration .....	13
<b>3 Post Screen Solution</b> .....	<b>15</b>
3.1 Overview.....	15
3.2 Networking Diagram .....	17
3.3 Required Software .....	17
3.4 Required Hardware Devices.....	17
3.5 Relevant Configuration .....	18
<b>4 General Operations</b> .....	<b>22</b>
4.1 Taurus Login .....	22
4.1.1 Taurus Login upon ViPlex Handy (Android and iOS) .....	22

---

4.1.2 Taurus Login upon ViPlex Express (Windows) ..... 23

# 1 Overview

## 1.1 About This Solution

Taurus series products are the second-generation multimedia players developed by NovaStar specially designed for the medium-small size LED full color displays, and applicable to all kinds of display devices as well as many application scenes.

AD player, mirror screen and post screen are used here as examples to describe the application solution of Taurus series products. Pictures of Taurus series products used in networking diagram are taken from T6 model.

For more information of Taurus series products, please visit [www.novastar.tech](http://www.novastar.tech) to download relevant documents.

## 1.2 Characteristics of the Application Solution

### 1.2.1 Synchronous Playing

This function makes several displays play the same image at the same time with high accuracy based on advanced synchronous playing and scheduling technologies.

The synchronous playing function could be enabled for different displays as long as following three requirements are met:

- The synchronous playing function has been enabled on the ViPlex or VNNOX.
- The time of multiple Taurus products are synchronized.
- Playing plans of multiple Taurus products are the same without random transition or media.

Advantages of the synchronous playing function are shown in Table 1-1.

Table 1-1 Synchronous playing

Object	Advantage
User	Improve advertisement and information broadcast effects
Environment	Improve city image and make the city more colorful
Display	Improve visual experience

Time could be synchronized through NTP and Lora modes from which the user could select one as required:

- NTP time synchronization: Taurus time synchronization is based on NTP server. No hardware is required to be added, and time synchronization accuracy depends on network speed. Consequently, network traffic will be consumed by using 4G network.
- Lora time synchronization: Master and slave devices are required to be set for Taurus. Time of the slave device is synchronized with that of the master device through Lora network, and therefore Lora device is required. This time synchronization method is applicable to events with high time synchronization requirement and does not consume network traffic, but its signal receiving depends on the environment and is limited by distance.

## 1.2.2 Smart Brightness Adjustment

Smart brightness adjustment includes auto brightness adjustment and timing brightness adjustment.

- Auto brightness adjustment: Display brightness will automatically adjust according to environment brightness.
- Timing brightness adjustment: Display brightness will automatically adjust to a specific value at a given point of time.

Taurus products have brightness sensor connectors. Connect the light sensor and set smart brightness adjustment rules on ViPlex to enable the smart brightness adjustment function.

Advantages of smart brightness adjustment are as shown in Table 1-2.

Table 1-2 Smart brightness adjustment

Object	Advantage
User	Reduce manual operations
Environment	Avoid light pollution
Display	Smarter

Taurus products support manual brightness adjustment as well.

## 1.2.3 4G Module

Taurus series products provide models of onboard 4G modules, and therefore 4G network could be used for Internet connection.

When mobile data network is enabled on ViPlex and priority requirements for signal selection are met, Taurus products with 4G module could connect to Internet.

Advantages of 4G module are as shown in Table 1-3.

Table 1-3 4G module

Object	Advantage
User	Solution transmission speed is fast without wiring operation
Environment	-

Display	All Internet connection methods are available to enable more application scenes
---------	---

## 1.2.4 Cluster Management

Display quantity increases fast following with the development of smart city and commercial application, and cluster solution of NovaStar emerges to uniformly manage and monitor numerous displays in different places.

- VNNOX: A cloud publishing service used to realize display remote content management and remote terminal control.
- NovaiCare: A cloud monitoring service used to realize display remote monitoring.

VNNOX and NovaiCare could be accessed to remotely and uniformly manage displays with PC, Pad or mobile phone as long as Internet is available.

Advantages of cluster management are as shown in Table 1-4.

Table 1-4 Cluster management

Object	Advantage
User	Remotely and uniformly manage and monitor numerous displays
Environment	Helpful for the development of the smart city
Display	Without limits on deployment position and quantity

## 1.3 Software Acquiring Method

Table 1-5 Software acquiring methods

Type	Description	Method
ViPlex Handy	It is a LAN-based display management software, including the one applicable to Android and iOS operating systems, is mainly used for display management as well as solution editing and publishing.	Scan the following QR code to download and install the APP.  You can also download the ViPlex Handy for iOS from App Store.
ViPlex Express	It is a LAN-based display management software applicable to the Windows operating system, and is mainly used for display	Visit <a href="http://www.novastar.tech">www.novastar.tech</a> , download and install the required software.

---

	management as well as solution editing and publishing.	
VNNOX	It is a safe cloud publishing service, and is mainly used for solution remote editing and publishing.	Visit <a href="http://www.vnnox.com">www.vnnox.com</a> for register and login.
NovaiCare	It is a safe cloud monitoring service, and is mainly used for display remote monitoring.	Visit <a href="http://www.novaicare.com">www.novaicare.com</a> for register and login.

# 2 AD Player and Mirror Screen Solution

## 2.1 Overview

AD player and mirror screen, the typical commercial display applications, are mainly used for information publishing and advertisement display, and can be placed at the shopping mall, hotel, office building, exhibition, bank, station and community.

There are two application modes for the mirror screen which is a mirror when the display is turned off.

There are many application modes for the AD player and mirror screen, and only typical applications are introduced in this chapter, including the single application, cluster application and splicing application.

Characteristics of the AD player and mirror screen of NovaStar are as shown in Table 2-1.

Table 2-1 AD player and mirror screen

Characteristic	Description	Required Configuration
Support for synchronous display	Application of advanced synchronous playing and dispatching technologies realize high-accuracy synchronous playing for the same image on different displays.	<ul style="list-style-type: none"><li>• Enable the synchronous playing function on the ViPlex or VNNOX.</li><li>• Set time synchronizing rules on the ViPlex or VNNOX.</li></ul>
Support for smart brightness adjustment	Automatic and timing brightness adjustment could reduce manual operation, and brightness filtering technology could help to avoid brightness interference to realize stable display brightness.	Set smart brightness adjustment rules on ViPlex.
Support for splicing playing	Both individual playing and splicing playing are available for multiple displays.	Set splicing-related parameters on ViPlex.
Support for selling advertisements played	During the process of solution scheduling, the	Edit solutions on VNNOX.



in different time periods	user can divide time periods as required to play the specified list in every time period.	
Support for media switching without blackout	Blackout does not occur during media switching process.	No need to set.
Support for generating play log	The Taurus products can generate play log, and the user can check and export the log on VNNOX.	No need to set.

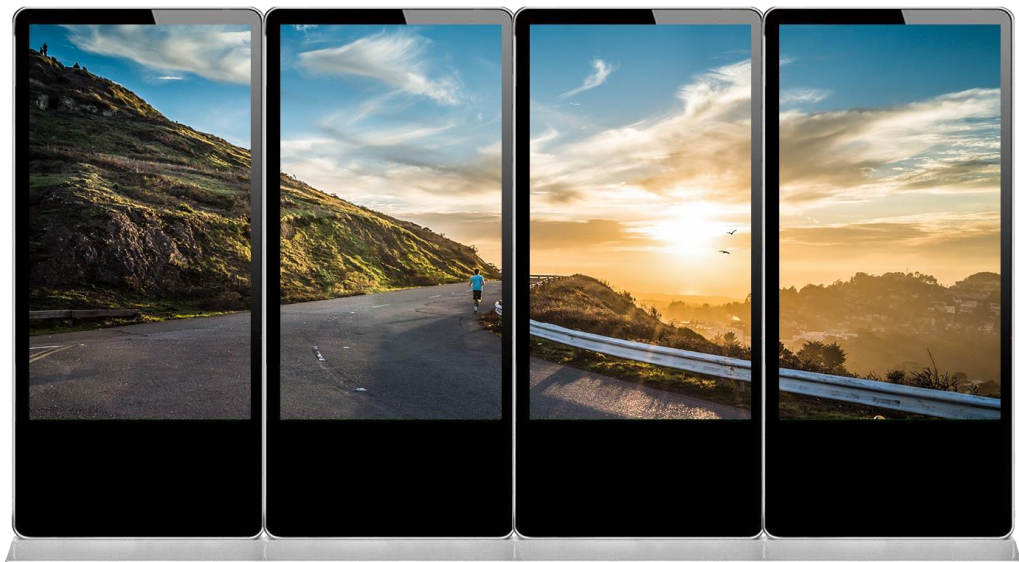
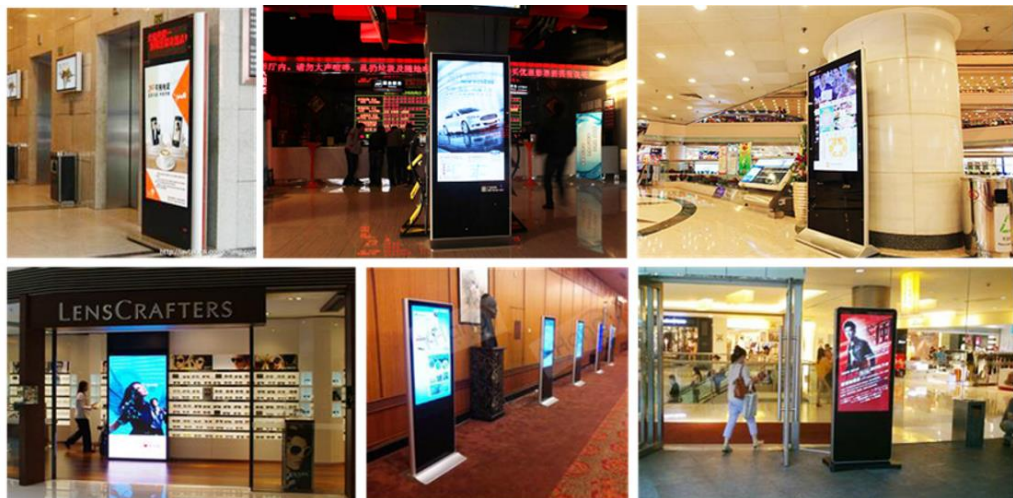

## 2.2 Single Application

### 2.2.1 Networking Diagram

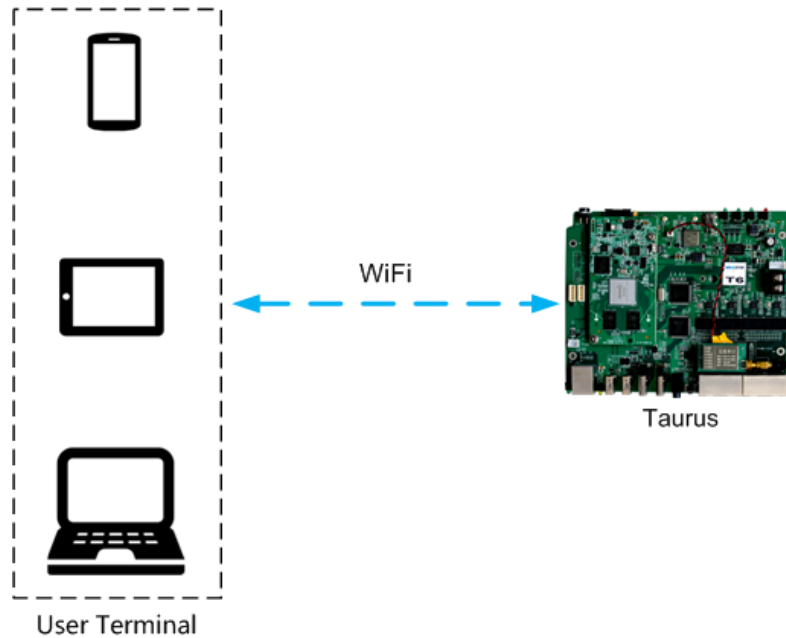

Taurus products provide Wi-Fi AP itself. After connecting to Wi-Fi AP with PC, Pad and mobile phone, enter the username and password to log in to the Taurus.

### 2.2.2 Required Software

- ViPlex Handy
- ViPlex Express

### 2.2.3 Relevant Configurations

No need to set. Refer to 4.1 "Taurus Login" for specific operations to connect and log in to the Taurus products.

## 2.3 Cluster Application

### 2.3.1 Networking Diagram

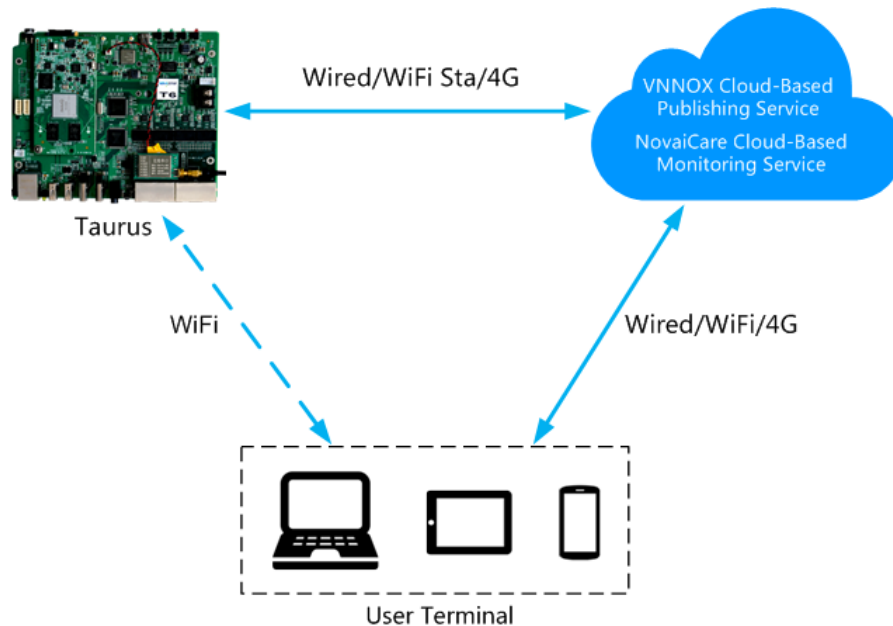

VNNOX and NovaiCare could be accessed directly or by way of bridge connection. When bridge connection is selected, following three methods for Internet connection of Taurus products are available with priorities ranging from high to low:

- Wired network
- WiFi Sta
- 4G network

When the three methods are all enabled, Taurus products will select signals automatically according to the priorities.

### 2.3.2 Required Software

- ViPlex Handy
- ViPlex Express
- VNNOX
- NovaiCare

### 2.3.3 Required Hardware Devices

Function	Required Hardware Device	Model
Synchronous playing	When Lora time synchronization is used, it is required to purchase Lora devices	<ul style="list-style-type: none"> <li>• E32-1W: Installed on the master device.</li> <li>• E32-100: Installed on the slave device.</li> </ul>
Smart brightness adjustment	Light sensor	NS048D

## 2.3.4 Relevant Configurations

### Before You Begin

- The login username and password for VNNOX, NovaiCare and NovaLCT-Taurus are acquired.
- Create solution(s) on VNNOX without random transition and random media of the solution(s).
- Create asynchronous players on VNNOX and associate the players with the License.
- Configurations required before monitoring have been done on NovaLCT-Taurus and NovaiCare.

Refer to software online help for specific operations of VNNOX, NovaiCare and NovaLCT-Taurus.

### Acquiring Player authentication information

Authentication information is required when ViPlex binds the asynchronous player of VNNOX.

Step 1 Visit <http://www.vnnox.com>, and click the **Login** button at the upper-right corner.

Step 2 Select the server node and click **Ok**.

Step 3 Enter the account name and password, and click **Login**.

Step 4 Select **Organization Management, System Management** from the pop-up menu of  in the upper right corner.

Step 5 Select the **Player Authentication** tab to view **Server address, Certified user name** and **Certified password**.



For following settings, do not exit VNNOX after above operations.

### Configuring ViPlex Handy (Android and iOS)

Step 1 Log in to the Taurus. Refer to 4.1.1 “Taurus Login upon ViPlex Handy (Android and iOS)”.

Step 2 Click screen name to enter **Screen management** page.

Step 3 Set rules for smart brightness adjustment.

1. Select **Screen Setting, Brightness control**.
2. Click **Brightness mode**, select **Smart**, and click **OK**.
3. Click **Smart adjustment parameters**.
4. Click  and select **Auto brightness adjust** to set time and duration for automatic adjustment, and then click **OK**.
5. Click **Auto adjustment parameters** to set the corresponding relationship between the environment brightness and display brightness, and then click **OK**.
6. Click  and select **schedule brightness adjust** to set the timing adjustment time and duration as well as display brightness value, and then click **OK**.
7. Click **Send** to send the smart brightness adjustment rules to the Taurus.

Step 4 Set the connection method between the Internet and Taurus.

Priorities of wired network, Wi-Fi Sta and 4G network range from high to low. When the three methods are all enabled, the Taurus will select signals automatically according to the priorities.

- Wired network: When static IP address is required, select **Network Setting, Wired Network Setting**, turn **DHCP** off, enter the static IP address of the Taurus, and click **OK**.
- WiFi Sta: Select **Network Setting, WiFi Setting**, and turn **WiFi** on. Click the Wi-Fi name of the external router and enter the Wi-Fi password, and click **OK**.
- 4G network: Select **Network Setting, Mobile Data Setting**, and turn **Mobile data** on.

Step 5 Bind the asynchronous player.

1. Select **Remote Management, Player Binding**.
2. Set the VNNOX server and player authentication information.
3. Click **Obtain** and select a player from the drop-down box of **Player**.
4. Click **OK** after setting.

Step 6 If display remote monitoring is required, perform the following procedures. Otherwise, ignore this step.

1. Select **Remote Management, Remote Monitor**.
2. Turn **Remote Monitor** on.
3. Select the service node of the NovaiCare from the drop-down box of **Server**.
4. Click the right side of **Possessor** line.
5. Enter the username for login NovaiCare in the pop-up dialog box, and click **OK**.
6. Click **OK** after setting.

Step 7 Repeat above steps to configure other Taurus products in cluster till all Taurus products have been configured.

## Configuring ViPlex Express (Windows)

Step 1 Log in Taurus and see detailed operations in 4.1.2 “Taurus Login upon ViPlex Express (Windows)”.

Step 2 Select **Screen Control**.

Step 3 Set rules for smart brightness adjustment.

**Currently not supported.**

Step 4 Set the way to connect Taurus to the Internet.

The priority of wired network, Wi-Fi Sta and 4G network is from high to low. If all of the three ways are enabled, the Taurus will choose signal automatically according to the priority order.

1. Select **Network configuration**.
2. Select the target terminal in the terminal list and perform the following operations according to actual needs.

- Wired network: If it is required to set static IP address, turn off **Dynamic DHCP**, enter the IP address information of the Taurus and then click **Apply** in the **Wired network configuration** section.
- WiFi Sta: Turn on **Wi-Fi** in the **Wi-Fi configuration** section. Click the Wi-Fi name of external router and then enter Wi-Fi password and click **Apply**.
- 4G network. Turn on **Mobile network** in the **Mobile network configuration** section.

Step 5 Bind asynchronous players.

1. Select **Server configuration**.
2. Select the target terminal in the terminal list.
3. Configure player authentication information in **Configure parameters for connecting screens to VNNOX**.
4. Click  next to **Player** and select a player.
5. Click **Apply**.

Step 6 If you want to monitor displays remotely, please perform this step; otherwise, skip this step.

1. Select **Enable** next to **NovaiCare configuration** in **Configure parameters for connecting screens to NovaiCare**.
2. Configure NovaiCare server address and login user name.
3. Click **Apply**.

Step 7 Repeat above steps until all the Taurus products in the cluster are configured.

## Configuring VNNOX

When setting timing rules and synchronous playing upon ViPlex, every Taurus product is required to be set individually, and batch setting is available for setting timing rules and synchronous playing upon VNNOX. When the public network is available, VNNOX is recommended for batch configuration to reduce manual operations.

Step 1 Set time synchronization rule.

1. Select **Players Management, Time Synchronization** from the pop-up menu of  in the upper right corner.
2. Click **NTP server configuration**.
3. Click **Add** to configure NTP service information, and then click **Save&Close**.
4. Click **New** on the page of time synchronization task list.
5. Enter time synchronization task name and select time synchronization method, and then click **Next**.
  - NTP: Select a NTP server and then click **Ok**.
  - LORA: Select a time synchronization standard device and then click **Ok**.
6. Click **Add** in the **Players** tab of the time synchronization task attribute page.
  - NTP time synchronization: Select all the players in cluster and then click **Ok**.
  - LORA time synchronization: Select all the slave players in Lora network and then click **Ok**.

7. When the time synchronization method upon Lora network is selected, and NTP server is used for the time synchronization standard device, click **Configure** tab to set **NTP** to **Yes**, and select NTP server. Otherwise, ignore this step.
8. Click **Save** or **Save&Close**. Players added in the time synchronization task will perform time synchronization according to rules defined in the task.

Step 2 If the same image is required to be played by different screens, perform the following procedures. Otherwise, ignore this step.

1. Select **Player Management, Players** in the pop-up menu of  in the upper right corner.
2. Select asynchronous players corresponding to all Taurus series products requiring enabling the synchronous playing function.
3. Click **Real-time control** and select **open the synchronous broadcasting** from the drop-down box.

Step 3 Associate with solution(s).

1. Select **Players Management, Players** from the pop-up menu of  in the upper right corner.
2. Select a player and click **Attribute**, or click a player name.
3. Select a solution from the drop-down box of parameter **associate solution**.
4. Whether solution distribution type is **Manual**.
  - Yes. Click **Save&Close** to return to the player list page. Perform term 5.
  - No. Click **Save** or **Save&Close**. VNNOX will automatically distribute solutions to corresponding Taurus products.
5. Select the target player, and click **Update solution** to manually distribute solutions to corresponding Taurus products.
6. Repeat above steps to associate with solutions for other players in cluster till all players have been configured.

## 2.4 Splicing

### 2.4.1 Networking Diagram

The following figure uses three displays splicing as an example to illustrate Taurus connection.



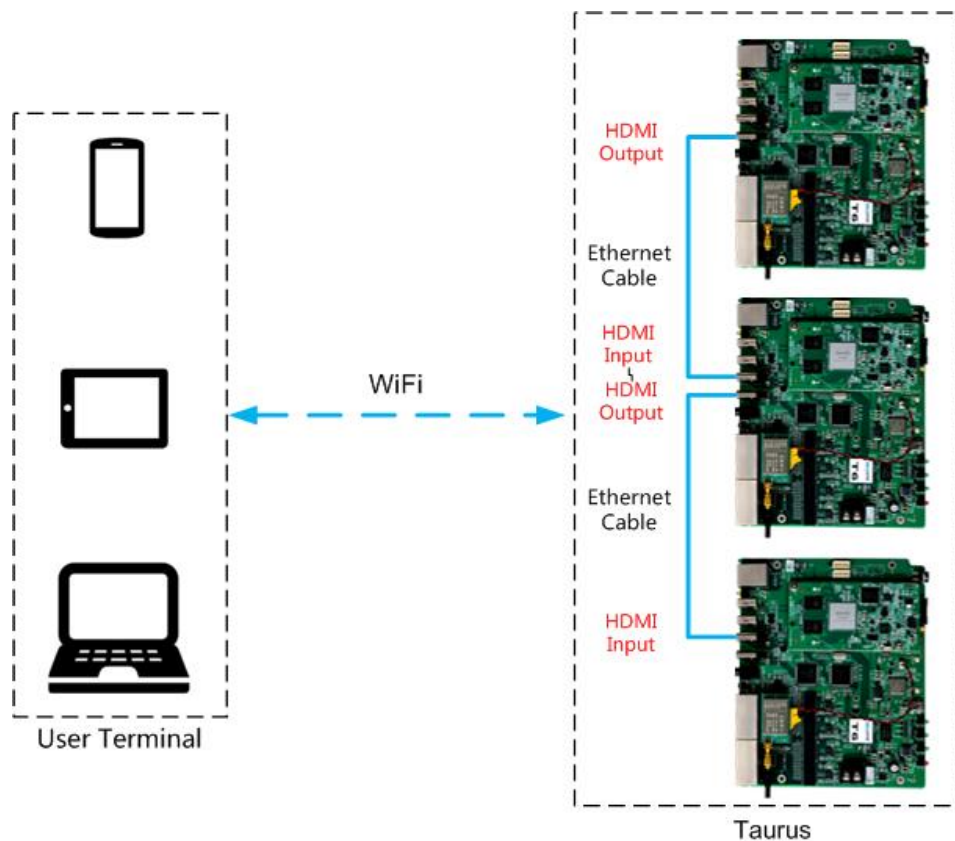

The Taurus product provides Wi-Fi AP itself. Connect to Wi-Fi AP of each Taurus product through PC, Pad and mobile phone, and then enter the username and password to log in to the Taurus.

## 2.4.2 Required Software

- ViPlex Handy
- ViPlex Express

## 2.4.3 Relevant Configuration

**ViPlex Express doesn't support following operations for the moment.**

### Configuring the first display

- Step 1 Log in to the Taurus of the first display. Refer to 4.1.1 “Taurus Login upon ViPlex Handy (Android and iOS)” for specific operations.
- Step 2 Click screen name to enter the **Screen management** page.
- Step 3 Select **Video Control**.
- Step 4 Configure the required parameters.
  - Mode: Manual
  - Source: inside
  - Offset X: 0
  - Offset Y: 0
- Step 5 Click **OK**.



## Configuring other displays

Step 1 Log in to the Taurus of the second display. Refer to 4.1.1 “Taurus Login upon ViPlex Handy (Android and iOS)” for specific operations.

Step 2 Click screen name to enter **Screen management** page.

Step 3 Select **Video Control**.

Step 4 Configure the required parameters.

Horizontal splicing image is taken as an example here for illustration. In the event of vertical splicing, the way for setting **Offset Y** is the same as that for setting **Offset X**.

- Mode: Manual
- Source: HDMI
- Offset X:  $(\text{The display serial number} - 1) \times \text{The Image width}$ . For example, when the image width is 500px, it is required to be set as 500px for the second display and 1000px for the third display.
- Offset Y: 0

Step 5 Click **OK**.

Step 6 Repeat above steps to configure other Taurus products till all Taurus products have been configured.

# 3 Post Screen Solution

## 3.1 Overview

Post screens prevail on both sides of highways and roads following with the development of the smart city. Smart post screen has distinct advantages compared with the conventional post which features illumination and static advertisement only and requires new manufacture and installation in case of advertisement replacement, while the smart post provides functions including illumination, security monitoring, environment monitoring, emergency call, charging pile and LED display which used high-definition smart LED post screen for road leading, data release and advertising promotion.

Post screens can be used without quantity limits, and the display contents can be controlled individually or in batch based on cluster management method.

Characteristics of the post screen of NovaStar are as shown in Table 3-1.

Table 3-1 Post screen

Characteristics	Description	Require Configuration
Support synchronous playing	Use advanced synchronous playing and scheduling technologies to make several displays play the same image at the same.	<ul style="list-style-type: none"> <li>• Enable the synchronous playing function on the ViPlex or VNNOX.</li> <li>• Set time synchronizing rules on the ViPlex or VNNOX.</li> </ul>
Support for smart brightness adjustment	Automatic and timing brightness adjustment could reduce manual operation, and brightness filtering technology could help to avoid brightness interference to realize stable display brightness.	Set smart brightness adjustment rules on ViPlex.
Support for selling advertisements played in different time periods	During the process of solution scheduling, the user can divide time periods as required to play the specified list in every time period.	Edit solutions on VNNOX.
Support for media switching without	Blackout does not occur during media switching	No need to set.

blackout	process.	
Support for generating play log	Taurus products can generate play log, and the user can check and export the log on VNNOX.	No need to set.
Support for remote solution publishing	VNNOX is a safe cloud publishing service which enables remote content management and remote terminal control for the LED display.	Visit <a href="http://www.vnnox.com">www.vnnox.com</a> for register and login.
Support for remote display monitoring on NovaiCare	NovaiCare is a safe cloud monitoring service which enables remote monitoring for the LED display.	Visit <a href="http://www.novaiCare.com">www.novaiCare.com</a> for register and login.
Support for environment monitoring	Onboard camera connector can monitor the environment surround the post screen.	No need to set.
Support for 4G module	Onboard 4G module can connect Internet through 4G network.	Turn on mobile data network on ViPlex.



## 3.2 Networking Diagram

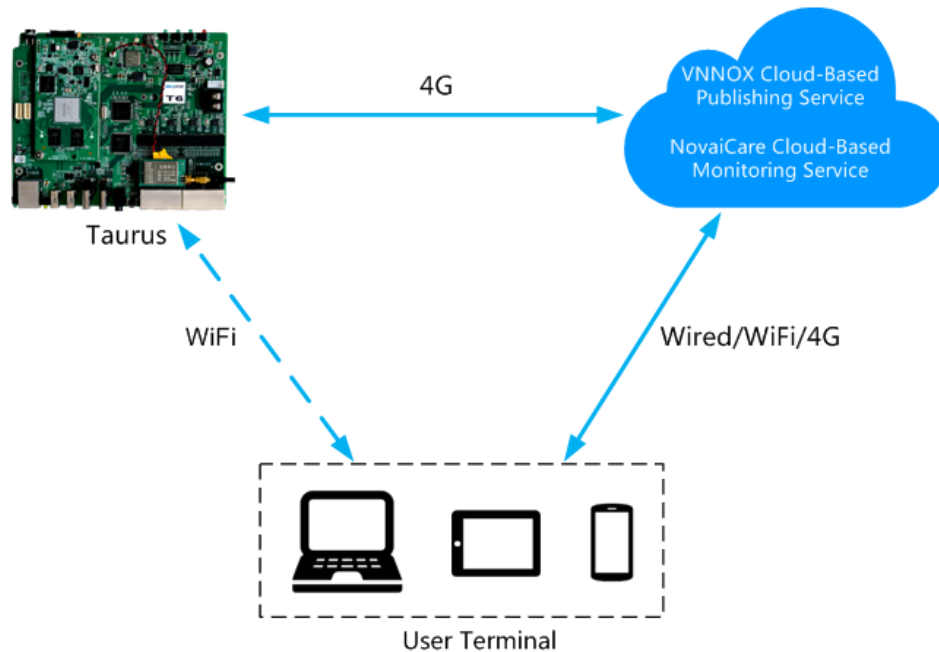

VVNOX and NovaiCare could be accessed directly or by way of bridge connection to centrally manage post screens.

Taurus products can connect to Internet through the wired network, Wi-Fi and 4G network which is recommended for this solution.

## 3.3 Required Software

- ViPlex Handy
- ViPlex Express
- VVNOX
- NovaiCare

## 3.4 Required Hardware Devices

Function	Required Hardware Device	Model
Synchronous playing	When Lora time synchronization is used, it is required to purchase Lora devices	<ul style="list-style-type: none"> <li>• E32-1W: Installed on the master device.</li> <li>• E32-100: Installed on the slave device.</li> </ul>
Smart brightness adjustment	Light sensor	NS048D

## 3.5 Relevant Configuration

### Before You Begin

- Acquire the login username and password of VNNOX, NovaiCare and NovaLCT-Taurus.
- Create a solution on the VNNOX without random transition and random media.
- Create an asynchronous player which associates with License on the VNNOX.
- Complete configurations required to be done before monitor on NovaLCT-Taurus and NovaiCare.

Refer to software online help for specific operations of VNNOX, NovaiCare and NovaLCT-Taurus.



### Acquiring player authentication information

- Step 1 Visit <http://www.vnnox.com> and then click **Login** in the upper right corner.
- Step 2 Select a server node and click **Ok**.
- Step 3 Enter the account name and password and then click **Login**.
- Step 4 Select **Organization Management, System Management** from the pop-up menu of  in the upper right corner.
- Step 5 Select the **Player Authentication** tab to view **Server address, Certified user name** and **Certified password**.

For following settings, do not exit VNNOX after above operations.

### Configuring ViPlex Handy (Android and iOS)

Following operations are required for every display in cluster.

- Step 1 Log in to the Taurus. Refer to 4.1.1 “Taurus Login upon ViPlex Handy (Android and iOS)” for specific operations.
- Step 2 Click the screen name to enter the **Screen management** page.
- Step 3 Set rules for smart brightness adjustment.
  1. Select **Screen Setting, Brightness control**.
  2. Click **Brightness mode** to select **Smart**, and then click **OK**.
  3. Click **Smart adjustment parameters**.
  4. Click  and select **Auto brightness adjust** to set automatic adjustment time and duration, and then click **OK**.
  5. Click **Auto adjustment parameters** to set the corresponding relationship between the environment brightness and display brightness, and then click **OK**.
  6. Click  and select **schedule brightness adjust** to set timing adjustment time and duration, and then click **OK**.
  7. Click **Send** to send rules for smart brightness adjustment to the Taurus.
- Step 4 Set Internet connection mode for the Taurus.
  1. Select **Network Setting, Mobile Data Setting**.

2. Turn **Mobile data** on.
- Step 5 Bind the asynchronous player.
1. Select **Remote Management, Player Binding**.
  2. Set the VNNOX server and player authentication information.
  3. Click **Obtain** and select a player from the dropdown box of **Player**.
  4. Click **OK** after setting.
- Step 6 If display remote monitoring is required, perform the following procedures. Otherwise, ignore this step.
1. Select **Remote Management, Remote Monitor**.
  2. Turn **Remote Monitor** on.
  3. Select the service node of NovaiCare from the dropdown box of **Server**.
  4. Click the right side of **Possessor** line.
  5. Enter the login username of NovaiCare in the pop-up dialog box, and click **OK**.
  6. Click **OK** after setting.
- Step 7 Repeat above steps to configure other Taurus products in cluster till all Taurus products have been configured.

## Configuring ViPlex Express (Windows)

- Step 1 Log in Taurus and see detailed operations in 4.1.2 “Taurus Login upon ViPlex Express (Windows)”.
- Step 2 Select **Screen Control**.
- Step 3 Set rules for smart brightness adjustment.
- Currently not supported.
- Step 4 Set the way to connect Taurus to the Internet.
1. Select **Network configuration**.
  2. Select the target terminal in the terminal list.
  3. Turn on **Mobile network** in the **Mobile network configuration** section.
- Step 5 Bind asynchronous players.
1. Select **Server configuration**.
  2. Select the target terminal in the terminal list.
  3. Configure player authentication information in **Configure parameters for connecting screens to VNNOX**.
  4. Click  next to **Player** and select a player.
  5. Click **Apply**.
- Step 6 If you want to monitor displays remotely, please perform this step; otherwise, skip this step.
1. Select **Enable** next to **NovaiCare configuration** in **Configure parameters for connecting screens to NovaiCare**.
  2. Configure NovaiCare server address and login user name.
  3. Click **Apply**.

Step 7 Repeat above steps until all the Taurus products in the cluster are configured.

## Configuring VNNOX

When setting timing rules and synchronous playing upon ViPlex, every Taurus product is required to be set individually, and batch setting is available for setting timing rules and synchronous playing upon VNNOX. When the public network is available, VNNOX is recommended for batch configuration to reduce manual operations.

Step 1 Set time synchronization mode.

1. Select **Players Management, Time Synchronization** from the pop-up menu of  in the upper right corner.
2. Click **NTP server configuration**.
3. Click **Add** to configure NTP service information, and then click **Save&Close**.
4. Click **New** on the page of time synchronization task list.
5. Enter time synchronization task name and select time synchronization method, and then click **Next**.
  - NTP: Select the NTP server and then click **Ok**.
  - LORA: Select a time synchronization standard device and then click **Ok**.
6. Click **Add** in the **Players** tab of the time synchronization task attribute page.
  - NTP time synchronization: Click all the players in cluster and then click **Ok**.
  - LORA time synchronization: Click all the slave players in Lora network and then click **Ok**.
7. When the time synchronization method upon Lora network is selected, and NTP server is used for the time synchronization standard device, click **Configure** tab to set **NTP** to **Yes**, and select NTP server. Otherwise, ignore this step.
8. Click **Save** or **Save&Close**. Players added in the time synchronization task will perform time synchronization according to rules defined in the task.

Step 2 If the same image is required to be played by different screens, perform the following procedures. Otherwise, ignore this step.

1. Select **Player Management, Players** in the pop-up menu of  in the upper right corner.
2. Select asynchronous players corresponding to all Taurus series products requiring enabling the synchronous playing function.
3. Click **Real-time control** and select **open the synchronous broadcasting** from the drop-down box.

Step 3 Associate with solution(s).

1. Select **Players Management, Players** from the pop-up menu of  in the upper right corner.
2. Select a player and click **Attribute**, or click a player name.
3. Select a solution from the drop-down box of parameter **associate solution**.
4. Whether solution distribution type is **Manual**.
  - Yes. Click **Save&Close** to return to the player list page, and perform term5.
  - No. Click **Save** or **Save&Close**. VNNOX will automatically distribute solutions to corresponding Taurus products.

5. Select the target player, and click **Update solution** to manually distribute solutions to corresponding Taurus products.
6. Repeat above steps to associate with solutions for other players in cluster till all players have been configured.



# 4 General Operations

## 4.1 Taurus Login

Taurus series products feature Wi-Fi AP function. This chapter takes Wi-Fi AP connection as an example to introduce the Taurus login method.

Other connection methods require hardware or software configuration. Refer to ***Taurus Series Multimedia Players Quick Start Guide*** for specific operations.

### 4.1.1 Taurus Login upon ViPlex Handy (Android and iOS)

#### Before You Begin

- Acquire the SSID and password of Wi-Fi AP of the Taurus. SSID is default to be composed of AP and the last 8 numbers of SN, and the password is default as “**12345678**”.
- Acquire the login password of user “admin” of which the default password is “**123456**”.



#### Operating procedures

ViPlex Handy can connect numerous Taurus products.

Step 1 Connect Wi-Fi AP of the Taurus series products.

Step 2 Start ViPlex Handy.

System can automatically detect the Taurus series products and refresh **Screen list**. Users can also slide down **Screen list** to manually refresh the list.

- : denotes that Taurus is online and you can log into it.
- : denotes that Taurus is offline and you cannot log into it.
- : denotes that Taurus login is successful.

Step 3 Click **Connect** behind the screen name.

Step 4 Enter username and password, and click **Login**.

## 4.1.2 Taurus Login upon ViPlex Express (Windows)

### Before You Begin

- Acquire the SSID and password of Wi-Fi AP of the Taurus. SSID is default to be composed of AP and the last 8 numbers of SN, and the password is default as “**12345678**”.
- Acquire the login password of user “admin” of which the default password is “**123456**”.



### Operating procedures

The ViPlex Express can connect numerous Taurus products.

Step 1 Connect the Wi-Fi AP of Taurus series products.



Step 2 Start the ViPlex Express.

Step 3 Click **Refresh** and the screen list will be displayed on the page.

- : denotes that Taurus is online and you can log into it.
- : denotes that Taurus is offline and you cannot log into it.
- : denotes that Taurus login is successful.

After the Taurus is found by ViPlex Express, the ViPlex express will try to log into to the Taurus with the default account or the account used for last login.

Step 4 Taurus login is successful or not.

- Yes.  appears and no further operation is required.
- No.  appears and then perform Step 5.

Step 5 Click **Connect** on the right of the screen information.

Step 6 Enter the username and password, and click **OK**.

# Taurus Series

## Multimedia Players



Version: V1.0.0

Doc. Number: NS120100152

**Implementation  
Instruction of the  
Synchronous  
Playing Solution**

---

---

# Change History

---

Version	Release Date	Description
V1.0.0	2017-07-20	The first version

---

# Table of Contents

---

<b>Change History</b> .....	<b>i</b>
<b>Table of Contents</b> .....	<b>ii</b>
<b>1 Overview</b> .....	<b>1</b>
1.1 About This Solution.....	1
1.2 Synchronous Playing Conditions.....	1
1.3 Time Synchronization.....	1
1.4 Lora Time Synchronization.....	2
1.5 Required Softwares.....	2
1.6 Required Hardware Devices.....	3
<b>2 Implementation of NTP Synchronization Plan</b> .....	<b>4</b>
2.1 NTP Time Synchronization in the LAN.....	4
2.1.1 NTP Server Configuration.....	4
2.1.2 Taurus Configuration.....	4
2.2 NTP Time Synchronization in the Public Network.....	5
<b>3 Implementation of Lora Time Synchronization Plan</b> .....	<b>7</b>
3.1 Lora Device Installation.....	7
3.2 Taurus Configuration.....	9
3.2.1 Configuration with ViPlex Handy (Android and iOS).....	9
3.2.2 Configuration with ViPlex Express (Windows).....	9
3.2.3 Configuration with VNNOX.....	10
<b>4 General Operations</b> .....	<b>11</b>
4.1 Taurus Login.....	11
4.1.1 Taurus Login with ViPlex Handy (Android and iOS).....	11
4.1.2 Taurus Login with ViPlex Express (Windows).....	12

# 1 Overview

## 1.1 About This Solution

Taurus series multimedia players support the synchronous playing function for multiple displays in asynchronous mode. This document is intended to instruct on-site workers and technicians to complete configurations related to the synchronous playing function.

## 1.2 Synchronous Playing Conditions

All following conditions are required to be met for synchronous playing:

- The player supports the synchronous playing function.  
The Taurus series multimedia player, launched by NovaStar, perfectly supports the synchronous playing function, uses advanced synchronous playing technology and scheduling technology to perform automatic calibration and synchronization in the playing process of each media based on time.
- Enable the synchronous playing function.  
Taurus series products feature the perfect software supporting program, and the user could enable the synchronous playing function through the ViPlex or VNNOX cloud publishing system.
- Time synchronization of Taurus series products  
Playing and scheduling technologies are based on time, and therefore time synchronization should be ensured for synchronous playing. Taurus series products support NTP and Lora time synchronization methods either of which can be selected as required.
- Feature the same playing plan without random transition or media.  
Playing plans sent to multiple Taurus series products must be the same without random transition or media.

## 1.3 Time Synchronization

When NTP time synchronization is used, time synchronization of the Taurus series products will be performed with NTP server as the time standard in LAN or Internet.

### Advantages

- Use network time synchronization technology without additional hardware.

- Time synchronization accuracy depends on the Internet speed, and therefore applicable to the case with low time synchronization requirement. It is recommended to use such technology in LAN or good 4G network.

### Disadvantages

- Time synchronization depends on the Internet conditions and speed.
- Additional 2GB network traffic will be consumed per month by a single terminal when 4G network is used.

## 1.4 Lora Time Synchronization

When NTP time synchronization is used, master and slave devices are required to be set for Taurus series products. Time of the slave device is synchronized with that of the master device through Lora network.

### Advantages

- It is independent of network environment with good time synchronization performance and applicable to the case with high time synchronization requirement.
- No network traffic will be consumed.
- Time synchronization is available for the groups of the Taurus series products.

### Disadvantages

- The Lora device should be purchased.
- There are limits on distance, and configurations should be performed based on the specific conditions to ensure that radio-frequency signal can be received.

## 1.5 Required Softwares

Table 1-1 Software acquiring methods

Type	Description	Method
ViPlex Handy	It is a LAN-based display management software, including the one applicable to Android and iOS operating systems, is mainly used for display management as well as solution editing and publishing.	Scan the following OR code to download and install the APP.  You can also download the ViPlex Handy for iOS

		from App Store.
ViPlexExpress	It is a LAN-based display management software applicable to the Windows operating system, and is mainly used for display management as well as solution editing and publishing.	Visit <a href="http://www.novastar.tech">www.novastar.tech</a> , download and install the required software.
VNNOX	It is a safe cloud publishing service, and is mainly used for solution remote editing and publishing.	Visit <a href="http://www.vnnox.com">www.vnnox.com</a> for register and login.

## 1.6 Required Hardware Devices

When Lora time synchronization is used, it is required to purchase Lora devices, as shown in Table 1-2.

Table 1-2 Required hardware devices

Required Hardware Devices	Model
Lora devices	<ul style="list-style-type: none"> <li>• E32-1W: Installed on the master device.</li> <li>• E32-100: Installed on the slave device.</li> </ul>



# 2 Implementation of NTP Synchronization Plan

Taurus series multimedia players support NTP time synchronization in the LAN or public network for which configured NTP server and the world-wide used NTP server independent of configuration are required respectively.

## 2.1 NTP Time Synchronization in the LAN

### 2.1.1 NTP Server Configuration

Configure the NTP server in the LAN and **record the domain name or IP address**.

The Personal Computer (PC) can be set with the NTP server by default. Refer to <http://note.youdao.com/share/?id=2efee9a613935113fa0f9a874b89047f&type=note#/> for details.

### 2.1.2 Taurus Configuration

Taurus series products can be configured with ViPlex only in the LAN. ViPlex includes ViPlex Handy and ViPlex Express. The user can choose one as required.

#### 2.1.2.1 Configuration with ViPlex Handy (Android and iOS)

- Step 1 Log in to the Taurus, and refer to 4.1.1 “Taurus Login with ViPlex Handy (Android and iOS)” for specific operations.
- Step 2 Click the screen name to enter the **Screen management** page.
- Step 3 Enable the synchronous playing function.
  1. Select **Advanced Setting, Advanced features**.
  2. Turn **Sync\_play** on.
- Step 4 Return to **Advanced Setting** page.
- Step 5 Configure NTP time synchronization.
  1. Select **Correct Time**.
  2. Click **Time mode**, select **NTP**, and click **OK**.
  3. Click **Server**.
  4. Turn **Time Auto-sync** on.

5. Click **New**, enter the name and visit the address of the NTP server, and then click **OK**. The visit address must be the same as the configured domain name or IP address.
  6. Click **OK**.
- Step 6 Repeat above steps to configure other Taurus series products requiring synchronous playing till all Taurus series products have been configured.

### 2.1.2.2 Configuration with ViPlex Express (Windows)

- Step 1 Log in to the Taurus. Refer to 4.1.2 “Taurus Login with ViPlex Express (Windows)” for specific operations.
- Step 2 Enable the synchronous playing function.
1. Select **Screen Control**.
  2. Select **Play management**.
  3. Select the target terminal in the terminal list, and select **Startup** next to **Synchronous Playing**.
  4. Click **Yes** in the pop-up dialog box.
  5. Close the **Play management** window.
- Step 3 Configure NTP time synchronization.
- Currently not supported.
- Step 4 Repeat above steps to configure other Taurus series products requiring synchronous playing till all Taurus series products have been configured.

## 2.2 NTP Time Synchronization in the Public Network

Configure each Taurus series product respectively when the synchronous playing and settings are enabled with ViPlex. Batch configuration could be available based on VNNOX. In the public network, VNNOX is recommended to reduce manual operations.

### Before You Begin

Bind the asynchronous player of VNNOX through ViPlex.

### Operating Procedures

- Step 1 Visit <http://www.vnnox.com> and click **Login** in the upper right corner.
- Step 2 Select the server node and click **Ok**.
- Step 3 Enter the account name and password, and click **Login**.
- Step 4 Enable the synchronous playing function in batch.
1. Select **Player Management, Players** in the pop-up menu of  in the upper right corner.
  2. Select asynchronous players corresponding to all Taurus series products requiring enabling the synchronous playing function.

3. Click **Real-time control** and select **open the synchronous broadcasting** from the drop-down box.

Step 5 Configure NTP time synchronization.

1. Select **Players Management, Time Synchronization** in the pop-up menu of  in the upper right corner.
2. Click **New** in the page of time synchronization task.
3. Enter the time synchronization task name, select **NTP** as the type of the time synchronization task, and then click **Next**.
4. Select **China** or **America** as required, and click **Ok**.
5. Click **Add** in the **Players** tab of the time synchronization task attribute page.
6. Select asynchronous players corresponding to all Taurus series products requiring enabling the synchronous playing function, and click **Ok**.
7. Click **Save** or **Save&Close**.

# 3 Implementation of Lora Time Synchronization Plan

Lora time synchronization requires setting one Taurus in Lora network as the master device and others as the slave devices. Only the master device is used as the standard time instead of loading the display, and the slave device is used for loading the display.

Time synchronization of the slave device is based on that of the master device. Range of the time synchronization is limited. Taurus supports NTP-standardized time synchronization for the master device. If the same NTP server is configured for the master devices of different Lora networks and the networks are normal, large-scale time synchronization can be enabled.

One Taurus series product requires one Lora device. The Taurus and Lora device of **E32-100** and **E32-1W** models should be purchased before the project implementation.

## 3.1 Lora Device Installation

The Lora device of **E32-1W** model is installed on the master device, and the Lora device of **E32-100** model is installed on the slave device.

- Step 1 Make sure to power off the Taurus.
- Step 2 Connect the antenna to the Lora device.

Figure 3-1 Lora Device

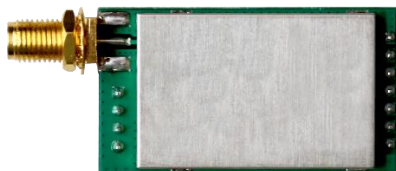

Figure 3-2 Antenna



Step 3 Install the Lora device on the Taurus. Figure 3-3 and Figure 3-4 show the Taurus of T3 model and T6 model installed with Lora devices.

Figure 3-3 Install the Lora Device on Taurus of T3 model

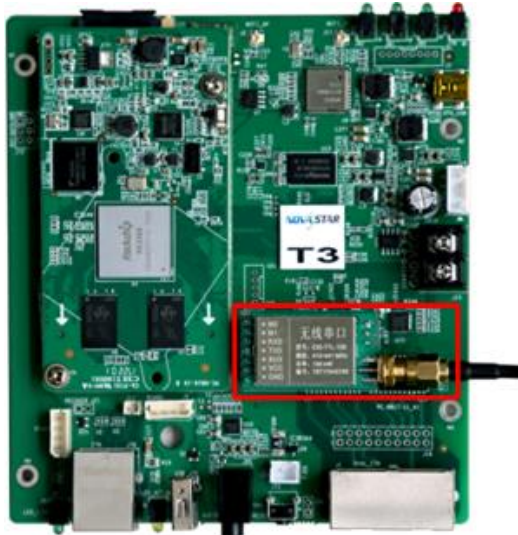

Figure 3-4 Install the Lora Device on Taurus of T6 Model



## 3.2 Taurus Configuration

When the public network is not available, the ViPlex, including ViPlex Handy and ViPlex Express, is applied to configure the Taurus, and the user could choose one as required.

When the public network is available, VNNOX is recommended for batch configuration to reduce manual operations.

### 3.2.1 Configuration with ViPlex Handy (Android and iOS)

- Step 1 Log in to the Taurus. Refer to 4.1.1 “Taurus Login with ViPlex Handy (Android and iOS)”.
- Step 2 Click the screen name to enter the **Screen management** page.
- Step 3 Enable the synchronous playing function. Please ignore this operation for the master device.
  1. Select **Advanced Setting, Advanced features**.
  2. Turn **Sync\_play** on.
- Step 4 Return to the **Advanced Setting** page.
- Step 5 Configure Lora time synchronization.
  1. Select **Correct Time**.
  2. Click **Time mode**, select **Lora**, and click **OK**.
  3. Click **Time parameter**.
    - Group ID: Use the same organization ID for the Taurus required enabling the time synchronization function to make such Taurus series products divide into the same Lora network.
    - Device type: Set the current Taurus as the master or slave device, and only one master device can exist in one organization. The slave device performs time synchronization through Lora network with the master device as time standard.
    - Time Auto-sync: When time synchronization of the master device is desired to be performed using the NTP server as the standard, automatic time synchronization function should be enabled, and NTP server address should be set.
  4. Click **OK** after the configuration.
- Step 6 Repeat above steps to configure other Taurus series products requiring synchronous playing till all Taurus series products have been configured.

### 3.2.2 Configuration with ViPlex Express (Windows)

- Step 1 Log in to the Taurus, and refer to 4.1.2 “Taurus Login with ViPlex Express (Windows)” for specific operations.
- Step 2 Enable the synchronous playing function. Please ignore this operation for the master device.
  1. Select **Screen Control**.
  2. Select **Play management**.



3. Select the target terminal in the terminal list, and select **Startup** next to **Synchronous Playing**.
  4. Click **Yes** in the pop-up dialog box.
  5. Close the **Play management** window.
- Step 3 Configure NTP time synchronization.
- Currently not supported.**
- Step 4 Repeat above steps to configure other Taurus series products requiring synchronous playing till all Taurus series products have been configured.

### 3.2.3 Configuration with VNNOX

#### Before You Begin

Bind the asynchronous player of VNNOX with ViPlex.

#### Operating Procedures

- Step 1 Visit <http://www.vnnox.com> and click **Login** in the upper right corner.
- Step 2 Select the server node and click **Ok**.
- Step 3 Enter the account name and password, and click **Login**.
- Step 4 Enable the synchronous playing function in batch.
  1. Select **Player Management, Players** in the pop-up menu of  in the upper right corner.
  2. Select asynchronous players corresponding to all Taurus series products requiring enabling the synchronous play function which is not required for the master device.
  3. Click **Real-time control** and select **open the synchronous broadcasting** from the drop-down box.
- Step 5 Configure Lora time synchronization.
  1. Select **Players Management, Time Synchronization** in the pop-up menu of  in the upper right corner.
  2. Click **New** in the page of time synchronization task.
  3. Enter the time synchronization task name, select **Lora** as the type of the time synchronization task, and then click **Next**.
  4. Select a standard device for time synchronization, and then click **Ok**.
  5. Click **Add** in the **Players** tab of the time synchronization task attribute page.
  6. Select asynchronous players corresponding to all slave devices requiring enabling the synchronous play function, and click **Ok**.
  7. When NTP server time synchronization is required, select the **Configure** tab, set NTP to **Yes**, and select the **NTP** server. Otherwise, ignore this step.
  8. Click **Save** or **Save&Close**.

# 4 General Operations

## 4.1 Taurus Login

Taurus series products feature the Wi-Fi AP function which is taken as the example by this chapter to introduce Taurus Login methods.

Other connection methods require hardware or software configuration. Refer to “Taurus Series Multimedia Players Quick Start Guide”.

### 4.1.1 Taurus Login with ViPlex Handy (Android and iOS)

#### Before You Begin

- Acquire the SSID and password of Wi-Fi AP of Taurus series products. SSID is default to be composed of AP and the last 8 numbers of SN, and the password is default as “**12345678**”.
- Acquire the login password of user “admin” of which the default password is “**123456**”.



#### Operating Procedures

ViPlex Handy can connect numerous Taurus series products.

Step 1 Connect Wi-Fi AP of the Taurus series products.

Step 2 Start ViPlex Handy.

System can automatically detect the Taurus series products and refresh **Screen list**. Users can also slide down **Screen list** to manually refresh the list.

- : denotes that Taurus is online and you can log into it.
- : denotes that Taurus is offline and you cannot log into it.
- : denotes that Taurus login is successful.

Step 3 Click **Connect** next to the screen name.

Step 4 Enter the user name and password and click **Login**.



## 4.1.2 Taurus Login with ViPlex Express (Windows)

### Before You Begin

- Acquire the SSID and password of Wi-Fi AP of Taurus series products. SSID is default to be composed of AP and the last 8 numbers of SN, and the password is default as “**12345678**”.
- Acquire the login password of user “admin” of which the default password is “**123456**”.



### Operating Procedures

ViPlex Express can connect numerous Taurus series products.

Step 1 Connect Wi-Fi AP of the Taurus series products.

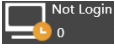

Step 2 Start the ViPlex Express.

Step 3 Click **Refresh** and the screen list will be displayed on the page.

- : denotes that Taurus is online and you can log into it.
- : denotes that Taurus is offline and you cannot log into it.
- : denotes that Taurus login is successful.

After the Taurus is found by ViPlex Express, the ViPlex express will try to log into to the Taurus with the default account or the account used for last login.

Step 4 Taurus login is successful or not.

- Yes.  appears and no further operation is required.
- No.  appears and then perform Step 5.

Step 5 Click **Connect** on the right of the screen information.

Step 6 Enter the username and password, and click **OK**.



# ViPlex Express

LAN-Based Screen Management Software



## User Guide

---

Version: V1.0.0

Document Number: NS120100148

---

## Change History

---

Version	Release Date	Description
V1.0.0	2017-07-20	First release.

---

# Table of Contents

---

<b>Change History .....</b>	<b>i</b>
<b>Table of Contents .....</b>	<b>ii</b>
<b>1 ViPlex Express Introduction .....</b>	<b>1</b>
<b>2 Installation of ViPlex Express.....</b>	<b>1</b>
<b>3 Login of Taurus .....</b>	<b>2</b>
<b>4 Program Management .....</b>	<b>3</b>
<b>5 Screen Control .....</b>	<b>5</b>
5.1 General Function .....	5
5.2 Play Management.....	5
5.3 Server Configuration.....	6
5.4 Network Configuration .....	6
5.5 Screen on/off .....	7
5.6 Screen Upgrade.....	8
5.7 Monitor.....	8
5.8 Screen Information .....	8
<b>6 System Settings .....</b>	<b>9</b>

---

# 1 ViPlex Express Introduction

---

Designed for Windows PC, ViPlex Express is the client software of the Taurus series multimedia players and mainly used for managing screens, editing and publishing programs.

Advantages:

- Friendly user interface: UI design takes full account of users' habits.
- Ease of use: The Taurus series players can be connected wirelessly and accessed easily.
- Synchronous playing: Capable of playing the same content on different screens synchronously.
- Dual Wi-Fi function: Capable of setting Wi-Fi AP mode and Wi-Fi Sta mode.
- 4G connection: Capable of setting mobile data network of the Taurus with 4G module.
- Terminal binding: The Taurus series players can be easily bound to the cloud-based publishing system VNNOX and the cloud-based monitoring system NovaiCare.

# 2 Installation of ViPlex Express

---

## Before You Begin

- Get the installation package of ViPlex Express.  
How to get: Visit [www.novastar.tech](http://www.novastar.tech).
- Install Framework 4.6.1 or above.

## Operating Procedures

- Step 1 Double click the installer "ViPlex Express V1.0.0 Setup.exe".
- Step 2 Click **Next** in the setup wizard.
- Step 3 Select installation path and click **Next**.
- Step 4 Select start menu folder and click **Next**.

- Step 5 Select additional tasks and click **Next**.
- Step 6 Click **Install**.
- Step 7 After the installation is done, select or deselect **Run ViPlex Express** and click **Finish**.

# 3 Login of Taurus

## Required Information

Get the actual values of the information in Table 3-1.



Table 3-1 Required information

Item	Account Name	Default Password
Connect Taurus WiFi AP	AP+last 8 digits of the SN For example: AP10000033	12345678
Log in Taurus	admin	123456



## Operating Procedures

ViPlex can connect multiple Taurus series products.

- Step 1 Connect the Taurus series products via the Wi-Fi AP of the Taurus, external router or Ethernet cable.
- Step 2 Start ViPlex Express.
- Step 3 Click **Refresh**, and the screen list appears.

- : Denotes that the Taurus is online and you can log in it.
- : Denotes that the Taurus is offline and you cannot log in it.
- : Denotes that logging in the Taurus is successful.

After Taurus is found by ViPlex Express, ViPlex Express will attempt to log in the Taurus automatically with the default account or the account used for last login.

- Step 4 Automatic Login is successful or not.
  - Yes.  is shown and the operation is finished.
  - No.  is shown. Then go to Step 5

- Step 5 Click **Connect** next to the screen information.
- Step 6 Enter your user name and password, and then click **OK**.

## Related Operations

Right click the screen information to see the related operations.

- Logout: Log out of the Taurus.
- Rename: Rename the Taurus.
- Password Modification: Modify the password used for the user “admin” to log in the Taurus.
- Forget password: Delete the user name and password used for last login.

If the user enter the password of the user “admin” to log in Taurus, ViPlex Express will automatically save the account information and the user can log in Taurus automatically in future. In case of selecting forget password, the user will need to enter the account information again while logging in Taurus in future.

# 4 Program Management

ViPlex Express supports the media formats shown in Table 4-1

Table 4-1 Media formats

Media Type	Format
Text	N/A
Image	JPEG, BMP, GIF, PNG, WEBP
Audio	MPEG, WMA, WAV, OGG, FLAC, AAC, AMR, MIDI
Video	MPEG-1/2, MPEG-4, H.264/AVC, MVC, H.265/HEVC, Google VP8, H.263, VC-1, Motion JPEG

## Create Programs

Get the screen size before creating programs.

Step 1 Click **New**.

Step 2 Enter playlist name, screen width and height, and then click **OK**. The editing page of the program appears, as shown in Figure 4-2. Each area of the page is explained in Table 4-2.

Figure 4-1 The editing page of a program

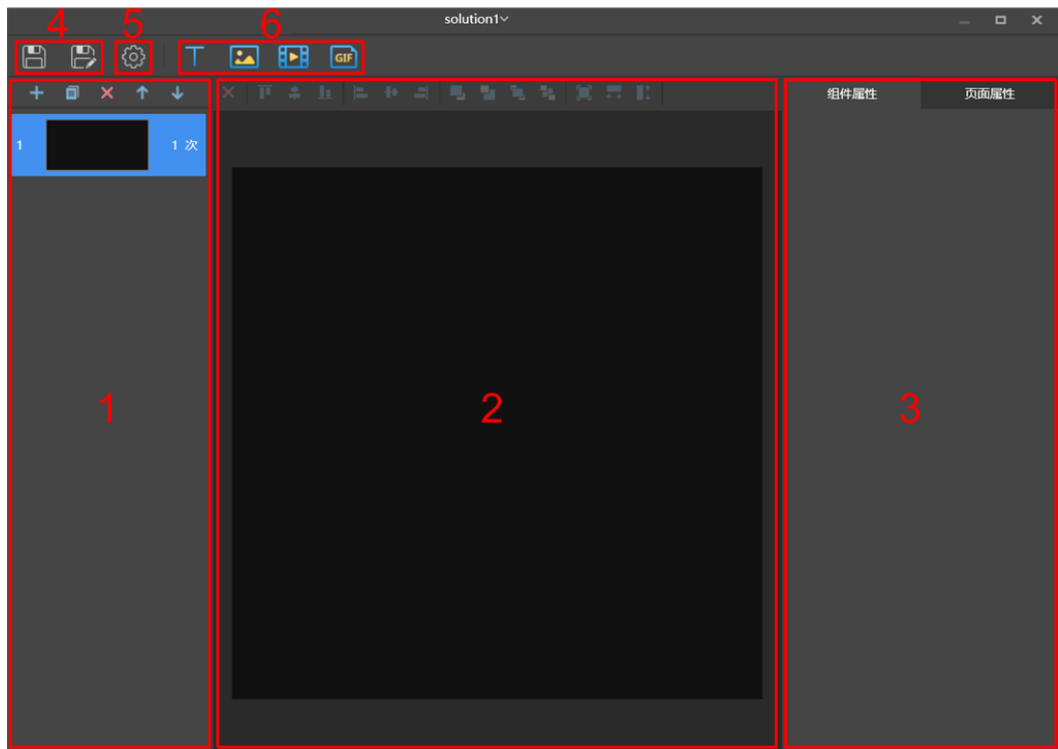



Table 4-2 Description of the editing page of a program

No.	Description
1	Editing area for creating, copying and deleting pages and adjusting the order of pages. Pages are played according to the order from the top to bottom.
2	Editing area of page media, for deleting media and adjust media layout. Click to select the media before operation.
3	Editing area for editing widget properties and page properties. Widgets are the media added in pages. Click to select a widget before editing the widget properties.
4	Buttons for saving a program and save a program as another program.
5	Setting button for setting the default duration of a program.
6	Buttons for adding media to a program page.

Step 3 After the program is edited, click  to save.

## Edit Programs

In the program list, select a program and click **Edit** to enter the editing page.

## Publish Programs

- A program can be published after media are added to the program.



- Only one program can be sent to terminals each time.
- One program can be sent to multiple terminals simultaneously.

- Step 1 Select a program in the program list and click **Publish**, or click  next to the program information.
- Step 2 Click **Refresh** in the **Playlist Release** dialog box to show the information of terminals which are logged in.
- Step 3 Select one or more terminals and click **Publish**.
- Step 4 When **Progress** shows 100%, click **Done**.

# 5 Screen Control

## 5.1 General Function

There is a **Read back** button in each of the functions of terminal control to read back terminal information to ViPlex Express so that the latest data are shown in the software.

## 5.2 Play Management

Manage the play mode, volume and content of terminals.

### Turn on Synchronous Playing

- Step 1 Select the target terminal in the terminal list.
- Step 2 Select **Startup** next to **Synchronous Playing**.
- Step 3 Click **Yes** in the pop-up dialog box.

### Adjust Volume in Real Time

Drag the slider or enter a value to adjust volume. Volume can be adjusted only in asynchronous mode.

### Play/Stop Programs

Play a program: Move the mouse to the thumbnail of the program and click .

Stop a program: Move the mouse to the thumbnail of the program and click .

---

## Delete Programs

Select programs in the program thumbnail list and click **Delete**.

## 5.3 Server Configuration

Bind VNNOX Player and NovaiCare.

### Bind VNNOX Player

Step 1 View player authentication information.

1. Visit <http://www.vnnox.com> and click **Login** at the top right of the page.
2. Select a server node and click **Ok**.
3. Enter your account name and password, and then click **Login**.
4. Select **Organization Management**, **System Management** in the pop-up menu of  at the top right of the page.
5. Select the **Player Authentication** tab and view server address, certified user name and password.

Step 2 Select the target terminal in the terminal list.

Step 3 Configure player authentication information in **Configure parameters for connecting screens to VNNOX**. The authentication information must be the same as the information on VNNOX.

Step 4 Click  next to **Player** and select a player.

Step 5 Click **Apply**.

### Bind NovaiCare

Step 1 Select **Enable** next to **NovaiCare configuration** in **Configure parameters for connecting screens to NovaiCare**.

Step 2 Configure NovaiCare server address and login user name.

Step 3 Click **Apply**.

## 5.4 Network Configuration

Configure current network, including wired network, Wi-Fi AP, Wi-Fi Sta and mobile network.

### Configure Wired Network

It is required to set static IP address for Taurus while connecting Taurus via Ethernet cable. Set IP address according actual needs while connect Taurus to the Internet via Ethernet cable,

Step 1 Select the target terminal in the terminal list.

Step 2 In **Wired network configuration**, perform the following operations according to actual needs.

- Select **Enable** next to **Dynamic DHCP** to get IP address automatically.
- Deselect **Enable** next to **Dynamic DHCP** and configure static IP address.

Step 3 Click **Apply**.

## Configure Wi-Fi AP

The default SSID of terminal Wi-Fi AP is "**AP + the last 8 digits of the SN**" and the default password is "**12345678**".

Step 1 Enter the SSID and password of terminal Wi-Fi AP.

Step 2 Click **Apply**.

## Configure Wi-Fi Sta

If the external router is connected to the Internet, terminals can access Internet via the external router after Wi-Fi Sta is configured.

Step 1 Turn on **Wi-Fi** in **Wi-Fi configuration**.

Step 2 Double click the Wi-Fi information of the external router, enter password and then click **OK**.

## Configure Mobile Network

Terminals with 4G module can access Internet via mobile data.

Step 1 Insert 4G card into the slot.

Step 2 Turn on **Mobile network**.

# 5.5 Screen on/off

Restart terminals immediately and configure restart rules.

## Restart Taurus



Step 1 Select the target terminal in the terminal list.



Step 2 Click **Restart promptly**.

Step 3 Click **Confirm** in the pop-up dialog box to restart the terminal immediately.

## Configure Restart Rules

Step 1 Perform the following operations according to actual needs.

- Create a rule: Click . Set the time and cycle to restart a terminal in the pop-up dialog box and then click **OK**.
- Modify a rule: Select a rule and click  to modify the time and cycle to restart a terminal and then click **OK**.

- Delete rules: Select one or more rules and click . Then click **Confirm** in the pop-up dialog box.
- Clear rules: Click  and then click **Confirm** in the pop-up dialog box.
- Enable rules: In the rule list, turn on **Sure to enable** next to a rule.

Step 2 After the configuration is done, click **Apply**.

## 5.6 Screen Upgrade

Upgrade the application software and system software of terminals.

**Note: Keep the power on during upgrade.**

### Upgrade Application Software

Step 1 Select **Screen software**.

Step 2 Select upgrade package path.

Step 3 Select one or more terminals in terminal information list and click **Upgrade**.

### Upgrade System Software

Step 1 Select **Screen system**.

Step 2 Select upgrade package path.

Step 3 Select one or more terminals in terminal information list and then click **Upgrade**.

## 5.7 Monitor

View terminal hardware information and play screenshot. Hardware information includes disk size, memory usage, CPU usage, CPU temperature and environment brightness.

## 5.8 Screen Information

Show terminal IP address, system software version, application software version, etc.

---

# 6 System Settings

---

Menu	Description
Language	Set system language, including Chinese and English.
Setting	Set the save path of files, including the configuration files of ViPlex Express, data, temporary files, etc.
About	Show the version of ViPlex Express and the official website of NovaStar.
Help	View <i>ViPlex Express User Guide</i> .