

# ATTO

OWNER'S MANUAL

---



[movinglife.com](http://movinglife.com)

*movinglife*<sup>™</sup>



WELCOME TO ATTO

tekst die u hier wilt weergeven.

---

Intentionally left blank

# WELCOME!

Welcome to MovingLife ATTO's family of users.

MovingLife mission is to produce topnotch superior quality products and services for the benefit of mobility-limited users. Made by professionals and real users, ATTO is handed to you knowing it will become not just another scooter but an extension of your body, part of your life. As such, we made an enormous effort to design and manufacture each and every one of its 500 parts with great attention and care, which we hope you will be able to appreciate. However, being human means, we are not perfect and therefore, for the benefit of both users and makers, we urge you to contact us with any remark, idea for a change, complaint and even complements! We want to hear it all, so please register your ATTO and give us a feedback on the appropriate form on our website.

Enjoy your ATTO!

## REGISTER NOW

Please visit MovingLife website and register your ATTO product. Once registered you will become part of the MovingLife community, receive safety notices and recall information and will be able to enjoy news, updates, and special benefits.

[www.movinglife.com/register](http://www.movinglife.com/register)

tekst die u hier wilt weergeven.

---

Intentionally left blank

# TABLE OF CONTENT

PREFACE .....	7
ABOUT THIS MANUAL .....	9
BACKGROUND .....	12
SAFETY .....	14
ATTONOMY .....	30
OPERATING ATTO .....	34
TRANSPORTING ATTO .....	70
TROUBLESHOOTING .....	72
MAINTENANCE .....	74
SPECIFICATIONS .....	80
LIMITED WARRANTY .....	84
CONTACT INFORMATION .....	78

tekst die u hier wilt weergeven.

---

Intentionally left blank

# PREFACE

## Important Notice

This document is delivered subject to the following conditions and restrictions:

This Owner's Manual contains proprietary information of MovingLife Ltd. This information is supplied solely for the purpose of assisting authorized users of MovingLife Ltd. products.

This manual is designed to serve as an accompanying document to the ATTO Mobility Scooter.

No part of the contents of this manual may be used for any other purposes, disclosed to any person or firm, or reproduced by any means, without the express prior written permission of MovingLife Ltd.

The text and drawings in this manual are for the purposes of illustration and reference only. The

specifications on which they are based are subject to change without notice.

## Trademarks

ATTO is a registered trademark of MovingLife Ltd.

Other company and brand, product and service names are for identification purposes only and may be trademarks or registered trademarks of their respective holders. Data is subject to change without notice.

This product is covered by MovingLife Ltd. patents pending.

### **▲ CAUTION**

Federal law restricts this device to sale by or on the order of a physician.



## Indications for Use

The MovingLife ATTO Mobility Scooter is an indoor scooter that provides transportation for a disabled or elderly person.

## Intended Users

A motorized three-wheeled vehicle is a battery-powered device intended for medical purposes that is used for outside transportation by disabled persons.

The ATTO is intended for people with an injury, physical disability, or medical condition which means that they are unable to walk or have difficulty in walking.

Intended users should assess eyesight, reaction time, balance and posture, ability to sit for long periods of time, concentration and ability to get on and off the mobility scooter. Intended users should be able to

judge distances, recognize obstacles and hazards, and be able to see pedestrians and other road users.

The intended user of ATTO is the occupant who will be driving it and who may be assisted by an assistant for non-driving operations such as opening and folding the mobility scooter.

# ABOUT THIS MANUAL

## NOTE

For information on opening the shipping container and unboxing ATTO please refer to the UNBOXING SUPPLEMENT located in the container box.

## Purpose of this manual

This Owner Manual is an essential tool for any user of a MovingLife ATTO. The manual includes usage and operation guidelines, warnings concerning dangers while operating the ATTO including when changing from the folded position to the drive position and vice versa, while driving and during transportation of the ATTO.

The purpose of the manual is to prepare you and get you acquainted with the product and all its capabilities. The manual is aimed at providing you with all the answers to questions that may arise during the operation and use of the ATTO. If you

encounter a question for which you have not found an answer, please contact a MovingLife dealer near you or the company's technical support via our web site [www.movinglife.com](http://www.movinglife.com)

## Symbols and warning

Please pay attention to all warnings and cautions in this Owner's Manual. They are here to help you prevent injuries and damages that may occur if you do not read or ignore the instructions.

### WARNING

The warning frame includes information concerning your safety and warnings of possible injuries.

### CAUTION

Caution is intended to draw your attention to a possible risk or damage to your ATTO and other properties.

tekst die u hier wilt weergeven.

---

#### NOTE

Some more general information we would like you to consider.

In this Owner's Manual, you will also find some additional special symbols and warning as follows:

#### PINCH POINT

Pinch Point warning: A pinch point warning refers to an area where you must pay extra attention to your fingers to be sure your fingers are not pinched between two metal parts.

#### REQUIRES TOOLS

Wrench warning: If you see a warning with a wrench and you are not a certified technician please ignore the instructions and seek a professional or contact MovingLife support to help you find one.

## Users and certified technicians

#### WARNING

THIS CLAUSE CONTAIN A MUST-READ INFORMATION CONCERNING USERS AND CERTIFIED TECHNICIANS.

This Owner's Manual contains important information for the safe operation and use of this product. DO NOT use this product or any available optional equipment without first reading and completely understanding these instructions and any additional instructional material supplied with this product or optional equipment. If you are unable to understand the warnings, cautions or instructions, contact a healthcare professional, an authorized MovingLife dealer or technical personnel before attempting to use this equipment – otherwise, injury or damage may occur.

**ATTO users:** do not service or operate this equipment without first reading and understanding this Owner's Manual. If you are unable to understand the warnings, cautions, and instructions, contact MovingLife technical support before attempting to service or operate this equipment – otherwise injury or damage may result. Procedures other than those described in this manual must be performed by a qualified technician.

**MovingLife Qualified Technicians:** do not service or operate this equipment without first reading and understanding the Owner's Manual and service manual. If you are unable to understand the warnings, cautions and instructions, contact MovingLife technical support before attempting to service or operate this equipment – otherwise, injury or damage may result.

**NOTE**

This Owner's Manual is compiled from the latest specifications and product information available at the time of publication. We reserve the right to make changes as they become necessary or available. Any changes to our products may result in slight variations between the illustrations and explanations in this manual and the product you have purchased.

## BACKGROUND

MovingLife's ATTO is an advanced-technology Class A mobility scooter, designed for use indoors and on sidewalks. When driving on a pavement you should follow the rules for pedestrians. You should give pedestrians priority and show consideration for other pavement users, particularly those with a hearing or visual impairment who may not be aware that you are there.

In most countries, mobility scooters may only be used by a disabled person, or by a nondisabled person who is demonstrating a vehicle before sale, training a disabled user or taking the vehicle to or from a place for maintenance or repair. A disabled person in this context is someone with an injury, physical disability, or medical condition which means that they are unable to walk or have difficulty in walking.

If you are using a mobility vehicle for the first time, or if it has been a while since you have driven one, you are strongly advised to get some training to ensure that you can steer and control the vehicle properly, especially on uneven surfaces. Your assessment should include checking your eyesight, reaction time, balance and posture, ability to sit for long periods of time, concentration and ability to get on and off the ATTO. You may also want to consider having a regular review of your driving skills.

Although in most countries there are no legal eyesight requirements, good vision is important for driving a mobility vehicle safely. You should be able to judge distances, recognize obstacles and hazards, and be able to see pedestrians and other road users. Poor eyesight could be a contributory factor in an accident and could make you liable for a compensation claim. Vision can change with age and you are recommended to have regular sight tests.

If you are eligible to be registered as severely sight impaired (blind), you should not drive a mobility scooter as this would put yourself and others at risk. If

you are eligible to be registered as sight impaired (partially sighted), you should speak to your optometrist or doctor.

If you regularly take medication that makes you drowsy, you should consider whether it would be safe to use a mobility scooter. If you are in any doubt, consult your doctor. You should not use a mobility scooter if you have been drinking alcohol.

ATTO can be used on footpaths, pavements, bridleways, and in pedestrian areas and can be used on the road if a pavement is not available, or where it is necessary to cross the road.

Subject to space availability and depending on local regulations, you may be able to travel in your ATTO on buses and trains, so long as those vehicles are constructed or adapted to carry a mobility scooter, and providing that your ATTO fits in.

## Certification and Compliance

The ATTO Mobility Scooter is designed to comply with

### NOTE

Laws and regulation may vary from country to country and from state to state. Always check with local authorities to ensure you can use your mobility scooter and of the restrictions that apply.

the following international safety requirements for medical electrical equipment:

Safety: EN 12184 and ISO 7176-15

EMC: ISO 7176-21

Risk Management: ISO 14971

Regulatory Compliance: EEC: Annex V of 93/42/EEC

The European Medical Devices Directive of 93/42/EEC classifies the ATTO Mobility Scooter as a Class I device  
Device cleared by FDA : K160909



# SAFETY

## Safety highlights



ATTO is not a toy and should not be used by children, unless they are the intended users who comply with laws and regulations and with the minimum requirements specified in the specification section of this Owner's Manual.



ATTO is not intended for show-off driving or any other use other than the intended use. This mobility scooter must be used only in areas intended for pedestrians and under conditions allowing safe use and good contact with the ground.



Beware of snow, ice, sleet, rain, strong wind, sand, broken glass and other obstacles and interferences. All those and other such irregularities are dangerous to you and to others and should be avoided to prevent injury and damage.



Do not try to descend or climb an incline with an angle greater than recommended. See the "Specifications" section of this Owner's Manual.

---

Always climb or descend an incline by driving straight up or straight down the incline.

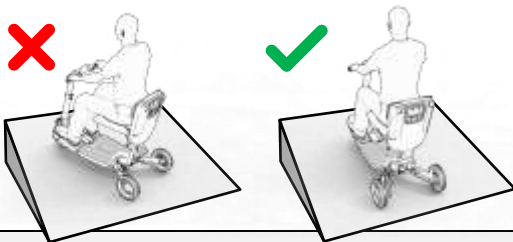

**⚠ WARNING**

Carefully read and follow the following safety instructions.

**⚠ CAUTION**

FIRST TIME USER – Do not operate your ATTO for the first time before reading and completely understanding this Owner's Manual.

## Safety and usage instructions

DISCLAIMER: MovingLife Ltd. is not and cannot be held responsible for any damage or injury incurred due to improper or unsafe use of the MovingLife's ATTO. MovingLife Ltd. specifically disclaims responsibility for any bodily injury or property damage that may occur during any use that does not comply with applicable federal, state, or local laws or ordinances.

### First time users

- Do not use this product or any available optional equipment without first reading and completely understanding these instructions. If you are unable to understand the warnings, cautions or instructions, contact a healthcare professional, an authorized MovingLife dealer or MovingLife technical support before attempting to use this equipment, otherwise, injury or damage may occur.



- There are certain situations, including some medical conditions, where the ATTO user will have to practice operating the ATTO in the presence of a trained attendant. A trained attendant can be defined as a family member or care professional especially trained in assisting an ATTO user in various daily living activities. Consult with your physician if you are taking any medication that may affect your ability to operate your ATTO safely.
- If you feel uncomfortable with your new ATTO or do not understand the instructions presented in this Owner's Manual, or if, for any reason, you do not feel capable of performing the activities necessary to open, fold, assemble, disassemble, operate, or maintain your ATTO, please contact the authorized MovingLife dealer you purchased this ATTO from or contact MovingLife technical support at the number showed on page 87.

## General

- Always turn the power off when the unit is not in use.
- Always make sure your seat is locked in fully opened position before driving your ATTO.
- Always remain properly seated when operating your ATTO.
- Use caution when driving on soft or uneven surfaces such as grass and gravel.
- Use caution on decks where there is no railing.
- Turning too sharply around a corner can cause the ATTO to tip over. Avoid this danger at all times by steering a wide arc around corners and obstacles. To avoid the risk of tipping over, reduce speed before negotiating any turns.
- For emergency stop, press the On/Off button.
- Never attempt to drive over or off obstacles higher than 20 mm (3/4") when driving forward and 18 mm (45/64") when driving in reverse. This could be unsafe and could damage the ATTO.

- Avoid turning off the power while the ATTO is moving. Doing so will cause the ATTO to come to an abrupt stop.
- Avoid reaching or bending while driving your ATTO. Bending forward creates the risk of accidental throttle lever contact. Bending sideways while seated creates the risk of tipping over. It is important to maintain a stable center of gravity and keep the ATTO from tipping.

## Driving in public

- Do not ride your ATTO in traffic, on public streets and roadways.
- Be aware that it may be difficult for traffic to see you when you are seated on the ATTO. Obey all local pedestrian traffic rules. Wait until your path is clear of traffic, and then proceed with extreme caution.
- If the power button is switched off while driving on horizontal level plan at maximum speed (limited by software) of 6.4 km/h (4 mph), it will come to a stop with a maximum stopping distance

of 1.1 m (about 4 ft). Please consider this distance when driving.

- Do not attempt to use your ATTO on stairs or escalators. Always use an elevator.
- Do not operate your ATTO where you could not safely or legally walk.
- Never operate your ATTO near steps or curbs where you might accidentally drop a wheel of the edge.
- Enter narrow driving paths/doorways slowly and with caution and always look out for additional obstacles such as car mirrors or door knobs.

## Sharp turns

- Avoid sudden starts while the handlebar is turned sharply.
- Do not make a sharp turn or a sudden stop while riding your ATTO.
- Always reduce your speed and maintain a stable center of gravity when cornering sharply. Do not corner sharply when driving at higher speeds.

tekst die u hier wilt weergeven.

---

- Always reduce the speed of your ATTO when making turns.

## Driving angles

- Do not attempt to climb ramps, slopes, curbs, or any low-rise slope with an angle greater than the limits specified on the Technical Specification.
- When climbing an incline, do not drive at an angle to the incline. Drive your ATTO straight up the incline. This greatly reduces the risk of tipping over or falling.
- For maximum stability, lean forward on your seat while proceeding up ramps, slopes, curbs, or any low rise.
- Drive with caution when attempting to negotiate any incline, even handicap access ramps.
- Do not traverse or drive across the face of a slope.
- Do not attempt to negotiate an incline that is covered with snow, ice, cut or wet grass, leaves, or any other potentially hazardous material.

- Try to keep your ATTO moving when climbing an incline. If you do come to a stop, restart and accelerate slowly and carefully.
- While you are driving down a slope, if your ATTO starts to move faster than you feel is safe, release the thumb lever and allow your ATTO to come to a stop. When you feel that you have gained control of your ATTO again, press the thumb lever and continue safely down the remainder of the slope.
- Do not place your ATTO in freewheel mode when on an incline or decline.
- Never park on inclines or declines.
- If you must stop on an incline, always lean forward to shift the center of gravity and prevent the ATTO from tipping over backwards.

## Reversing

- Make sure that there are no obstacles behind you while reversing your ATTO.

- Do not attempt to have your ATTO move backward down any step, curb or other obstacle. This may cause the ATTO to fall or tip over.

## Arms and legs

- When getting on or off your ATTO, do not put most or all of your weight on the edge of the deck. Doing so may cause the ATTO to tip over.
- Do not leave your hands and legs off the ATTO when driving.
- Keep your hands and legs away from the wheels while driving the ATTO. Be aware that loose fitting clothing may get caught in moving parts.
- Always keep your legs on the feet pads while you are seated on your ATTO.

## Weather

- Do not operate or store your ATTO where it will be exposed to rain, snow, mist, and below freezing temperatures.

- Do not operate your ATTO during stormy weather to reduce the risk of an accident or possible damage to the ATTO
- Operating in rain, snow, salt, mist conditions and on icy or slippery surfaces may have an adverse effect on the electrical system.
- The temperature of ATTO surfaces that can come into direct contact with the driver and/or assistant's skin during normal use and which are within the driver reach shall not exceed 41°C. The motor surface can reach temperatures greater than 41°C after driving. Do not touch these parts when folding or unfolding the ATTO or wait until the motor is cooled down.
- Do not touch the motor when folding or unfolding the ATTO, until the motor is cooled down.
- Do not hose down your ATTO.
- Maintain and store ATTO in a clean and dry condition and avoid exposure to rain, snow, ice, salt, or standing water.

## Power off

- To prevent injury to yourself or others, always ensure that the power is switched off when getting on or off the ATTO.

## Freewheel

For information on setting the ATTO in Freewheel mode see the “Operating the freewheel” section in this manual.

- Always check that the front wheel is engaged (not in freewheel mode) before driving. Do not switch off the power when the ATTO is still moving forward. This will bring the ATTO to a very abrupt stop.
- Be aware when the drive wheel is unlocked (freewheel mode) or locked (driving mode).
- The drive-wheel has to be switched to engaged-mode (not in freewheel mode) while transporting the ATTO. For instruction see the Freewheel section on page 63.

- Never sit on your ATTO when it is in freewheel mode.

## Lifting

- Do not attempt to lift or move your ATTO by any of its removable parts including the seat or driving console. Personal injury and damage to the ATTO may result.

## Load

- Never use the ATTO to carry or tow, push or pull anything but yourself.
- You may use dedicated accessories approved by MovingLife to carry shopping bags and a small luggage only if done according to instructions and only if the combined weight of the passenger plus load does not exceed the maximum allowed weight of the ATTO.

## Medical condition

- Never operate the ATTO while you are under the influence of alcohol.
- Never operate the ATTO if your health condition or medications you are taking cause you to feel dizzy, affect your vision, or affect your ability to safely operate the ATTO in any other way.
- Consult your physician if you are taking prescribed medication or if you have any physical limitations. Some medications and limitations may impair your ability to operate the ATTO in a safe manner.

## External devices

- Contact with tools can cause electrical shock.
- Do not connect or allow anyone except an authorized MovingLife representative to connect any electrical or mechanical device to your ATTO. Unauthorized accessories will void the warranty and may cause damage or injury.

## Unusual usage

- Never try to use your ATTO beyond its limitations as detailed in this Owner's Manual.
- Never sit on your ATTO while it is in a moving vehicle.
- Never sit on your ATTO when it is being used in connection with any type of lift or elevation product. Your ATTO is not designed with such use in mind and MovingLife shall not be liable to any damage or injury incurred from such use.
- Programming of the controller shall only be carried out by authorized personnel. Incorrect programming can result in safety hazards for the driver.

## Battery and charger

- Do not allow unsupervised children to play near this equipment while the batteries are charging.
- Never charge a frozen battery.
- If you encounter a damaged or cracked battery, immediately enclose it in a plastic bag and call

tekst die u hier wilt weergeven.

---

your authorized MovingLife dealer for recycle and disposal instructions.

- Always avoid/prevent damage to AC and DC cords.
- Do not connect an extension cord to the battery charger
- Use only original MovingLife Li-Ion battery.

## Modifications

### **▲ WARNING**

This product has been designed and engineered to provide maximum utility. However, under no circumstances should you modify, add, remove, or disable any part or function of your ATTO. Personal injury and damage to the ATTO may result.

1. Do not modify your ATTO in any way not authorized by MovingLife.
2. Do not use accessories if they have not been tested or approved by MovingLife.

3. Get to know the feel of your ATTO and its capabilities. We recommend that you perform a safety check before each use to make sure your ATTO operates safely.

## Weight limitation

### **▲ WARNING**

1. Please refer to the specifications table for weight capacity information.
2. Stay within the specified weight capacity for your ATTO. Exceeding the weight capacity voids your warranty. The manufacturer will not be held responsible for injuries or property damage resulting from failure to observe weight limitations.
3. Do not carry passengers on the ATTO. Carrying passengers on the ATTO may affect the center of gravity, resulting in tipping over or a falling.

## Temperature

### **⚠ WARNING**

1. Some of the parts of the ATTO are susceptible to change in temperature. The controller can only operate in temperature that ranges between minus 20°C and plus 50°C.
2. At extreme low temperatures the batteries may freeze, and your ATTO may not operate. In extreme high temperatures it may operate at slower speeds due to a safety feature of the controller, which prevents damage to the motors and other electrical components.
3. ATTO surfaces temperatures can increase or decrease when exposed to external sources of heat or cold (e.g. sunlight, outdoor environment).



tekst die u hier wilt weergeven.

## Safety labels

The following safety symbols are used on ATTO to identify warnings, mandatory actions and prohibited actions. It is very important for you to read and understand them completely.



Place unit on level ground when changing from “D” drive mode to “N” freewheel mode or freewheel mode to drive mode.

N = Unlocked / freewheel.

D = Locked / drive mode.



Do not lift handle while seated

Do not lift marked handle while seated on ATTO.



Marked handle is not intended for product lifting.



ATTO may topple when not in parking mode.



Marked handle must not be used while ATTO in opened position.



Indicates front module weight in kilograms.



Indicates ATTO's maximum user weight capacity. Indicates rear module weight in kilograms.



Pinch/Crush points created during the operation of ATTO (opening, closing, assembly, and disassembly).



Indicate ATTO's maximum user weight capacity.

Reduce speed to minimum when approaching incline or a turn.

Avoid ascending or descending ramps, curbs or slopes greater than 6 Deg.

Avoid sharp turns or sudden stops.

## Damaged labels

In case labels are unreadable for any reason, please consult this chapter and contact MovingLife for a new set of labels free of charge.

## Compliance and Warning Labels

The ATTO Mobility Scooter system components are equipped with various product compliance labels and icons. These are strategically positioned to provide important information regarding safe operation of the system.

For a description of the labels and symbols used as well as details of their location, refer to the following:

- Safety Rating and Manufacturer Identification Label on page 78.
- Symbols and Descriptions on pages 24-24.

**NOTE:** Additional labels used on system controls, accessories and disposables are illustrated and described in the following sections:

- Labels on ATTO Mobility Scooter Controls on page 24.

## EMC information

### **⚠ WARNING**

It is very important that you read this information regarding the possible effects of electromagnetic interference on your ATTO.

### Electromagnetic Interference (EMI) from radio wave sources

Mobility scooters may be susceptible to electromagnetic interference (EMI), which is interfering electromagnetic energy (EM) emitted from sources such as radio stations, TV stations, amateur radio (HAM) transmitters, two-way radios, and cellular phones. The interference (from radio wave sources) can cause the mobility scooter to release its brakes, move by itself, or move in unintended directions. It can also permanently damage the mobility scooter control system. The intensity of the

interfering EM energy can be measured in volts per meter (V/m).

Each mobility scooter can resist EMI up to certain intensity. This is called the "EMI immunity level". The higher the EMI immunity level, the greater the protection from EMI. Currently the ATTO technology has an immunity level of at least 20 V/m, which provides useful protection from the more common sources of EMI.

There are a number of sources of relatively intense electromagnetic fields in the daily environment. Some of these sources are obvious and easy to avoid. Others are not apparent and exposure is unavoidable. However, we believe that by following the warning listed below, your risk to EMI will be minimized.

The sources of radiated EMI can be broadly classified into three types:

1) Hand-held portable transceivers. These are transmitters-receivers with the antenna mounted directly on the transmitting unit. These devices include citizens band (CB) radios, walkie-talkies,

security, fire and police transceivers, cellular telephones, and other personal communication devices).

**NOTE:** Some cellular telephones and similar devices transmit signals while they are on, even when not being used.

2) Medium-range mobile transceivers, such as those used in police cars, fire trucks, ambulances and taxis. These usually have the antenna mounted on the outside of the vehicle.

3) Long-range transmitters and transceivers, such as commercial broadcast transmitters (radio and TV broadcast antenna towers) and amateur (HAM) radios.

**NOTE:** Other types of hand-held devices, such as cordless phones, laptop computers, AM/FM radios, TV sets, CD players, cassette players, and small appliances such as electric shavers and hair dryers are not likely to cause EMI problems to your ATTO, as far as we know.

## Mobility Scooter Electromagnetic Interference (EMI)

Because EM energy rapidly becomes more intense as one moves closer to the transmitting antenna (source), the EM fields from hand-held radio wave sources (transceivers) are of special concern. It is possible to unintentionally bring high levels of EM energy very close to the mobility scooter control system while using these devices. This can affect mobility scooter movement and braking.

Therefore, the warnings listed below are intended to prevent possible interference with the control system of the ATTO. Electromagnetic interference (EMI) from sources such as radio and TV stations, amateur radio (HAM) transmitters, two-way radios, and cellular phones can affect mobility scooters.

**⚠ WARNING**

Following the warnings listed below should reduce the chance of unintended brake release or scooter movement, which could result in serious injury.

- 1) Do not operate hand-held transceivers (transmitters receivers), such as citizens band (CB) radios, or turn on personal communication devices such as cellular phones while the ATTO is turned ON;
- 2) Be aware of nearby transmitters, such as radio or TV stations, and try to avoid getting close to them;
- 3) If unintended movement or brake release occurs, turn the ATTO OFF as soon as it is safe;
- 4) Be aware that adding accessories or components, or modifying the ATTO, may make it more susceptible to EMI (**NOTE:** There is no easy way to evaluate their effect on the overall EMI immunity of the ATTO);
- 5) Report all incidents of unintended movement or brake release to the ATTO manufacturer

and note whether there is a source of EMI nearby.

## Important

EMI/RFI – ATTO has passed an EMI immunity test according to EN 60601-1 Class B.

Modification of any kind to the electronics of the ATTO as manufactured by MovingLife may adversely affect the EMI immunity levels.

**⚠ WARNING**

The operation of the ATTO might disturb the operation of devices in its environment due to emitting of electromagnetic fields (e.g. alarm systems of shops, automatic doors, etc.).

## Radiation

The ATTO Mobility Scooter does not generate any hazardous radiation.

tekst die u hier wilt weergeven.

---

## ATOMY



Figure 1 - ATTO in folded mode



Figure 2 - ATTO in driving mode



tekst die u hier wilt weergeven.

---



---

Figure 3 – ATTO in trolley mode

---

# OPERATING ATTO

ATTO is very easy to operate; it requires no special skills and can be learned by following the steps described in the following pages and by practice.

The first step is reading through this chapter of the Owner's Manual and understanding the sequence of steps required for opening and closing (folding) the ATTO. Once completed, use the manual to guide you while you practice each step. It may be difficult at first but will be very easy once you have practice it several times.

To help you learn we have created a simple video you can watch under the videos section of our website:

[www.movinglife.com/videos](http://www.movinglife.com/videos)

## WARNING

Injury hazard due to improper assembly, disassembly, opening or closing ATTO. Ensure that all components in the ATTO have been correctly placed before continuing to the next step. Always check that all locked devices are holding correctly.

## Opening

1. Make sure your ATTO is on flat ground before opening. Make sure you have clearance of 2 meters (7 feet) from the side of the back wheels.

## PINCH POINT

Operations described below are done near and around pinching points. Be careful and follow instructions to prevent injury. Make sure your fingers are away from moving parts that may be closing gaps while moving.

2. Release the adjustment lever of the handle bar (1) and bring the handle bar to an upright position (2), then bring the lever back to its secured position (3). (see Figure 4).

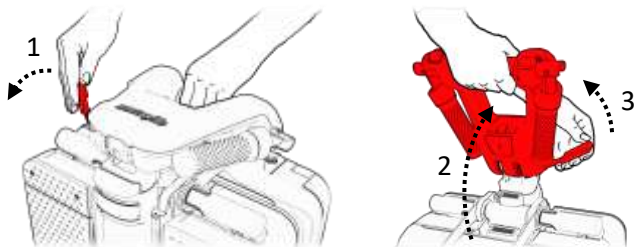

Figure 4

3. Press the central release button until it clicks and remains pressed (see Figure 5).



Figure 5

4. Press the rod button (1) and tilt it away from the main ATTO body (2). (see Figure 6).

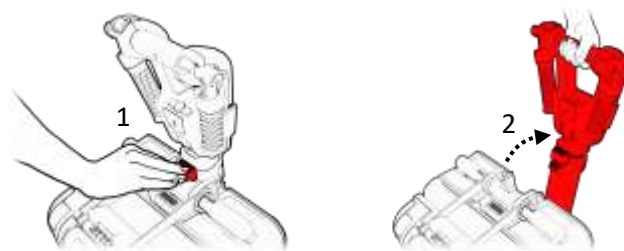

Figure 6

5. Hold ATTO by the main handle and the handlebar (see Figure 7).

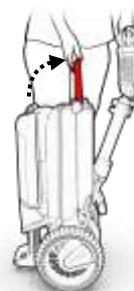

Figure 7

die u hier wilt weergeven.

6. Tilt ATTO toward the rod until the front wheel touches the ground (see Figure 8).



Figure 8

7. Using the main handle, pull the main body away from the rod, thus rolling the back wheels away from the front wheel (see Figure 9).



Figure 9

8. Gently move the handle down until ATTO is flat (see Figure 10).

**NOTE**

Keep holding the rod at upright position.



Figure 10

9. Place handle in its designated place (see Figure 11).

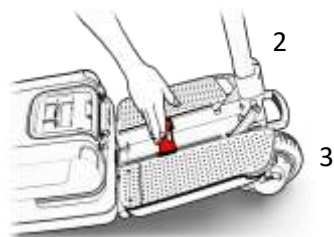

Figure 11

10. Lock the rod in upright position by pushing the front lever down until it clicks and locks in place (1) (see Figure 12). In case the front lever requires too much force to operate, you should apply horizontal pressure on the main handle towards the front of the ATTO (2). This will release the pressure on the front lever and will make it easier to lock (3).

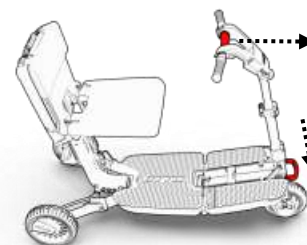

Figure 12



die u hier wilt weergeven.

---

11. Place one hand on the tiller and with the other hand release the secure lever of the back handle (1) and bring the handle to upright position at 90 degrees (2). (see Figure 13).

**NOTE**

For proper operation please do not flip the handle to 180 degrees from closed position. If you did and you are unable to lift the chair backwards, return the handle to its original position and try again.

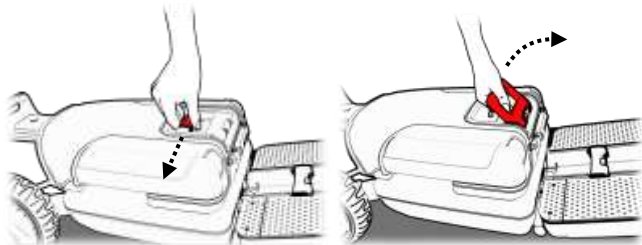

1

2  
90°

---

Figure 13

---

Using the handle, pull the back of the chair backwards until it clicks and locks in place (see Figure 14).



Figure 14

12. Continue using the handle for pulling up the chair until it clicks and locks in place (see Figure 15).

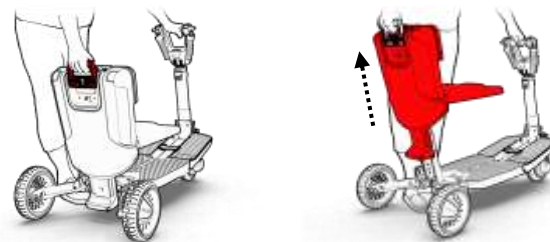

Figure 15

13. Open both sides of the handle bar (see Figure 16).

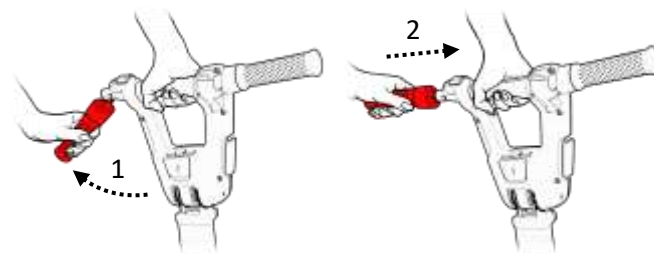

Figure 16

**⚠ WARNING**

Do not sit on the chair before it clicks in place to prevent it from sliding down again.



die u hier wilt weergeven.

## Adjusting for maximum comfort

Several adjustments can be made for maximum comfort. Some adjustments can be made by the user, while other adjustments **must only be made by a certified technician**. The adjustments that can be made by the user are detailed in this section.

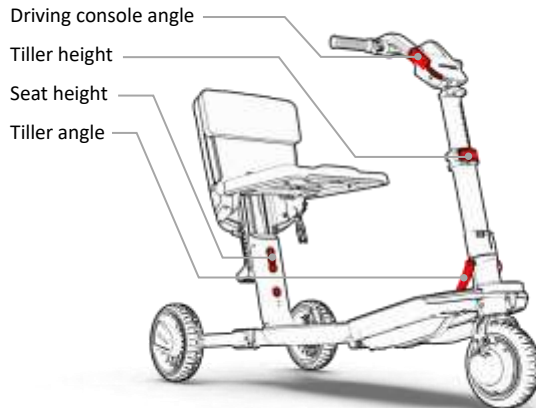

Figure 17 Comfort adjustments

### PINCH POINT

Operations described in this chapter are performed near and around pinching points. Be careful and follow instructions to prevent injury. Make sure your fingers are away from moving parts that may be closing gaps while moving.

## Adjusting Driving Console height

Open the rod lever and hold it (1) while adjusting the height of the handle bar at your convenience (2). Bring the lever back to the secure position once you're done (3). (see Figure 18).

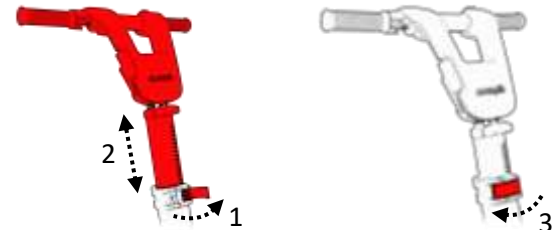

Figure 18 Driving Console height lever

## Adjusting Driving Console angle

ATTO's Driving Console can be adjusted to your comfort in a variety of angles. To adjust the Driving Console, you should first be seated on your ATTO:

1. Hold the Driving Console in one hand and release the adjusting lever using the other hand (1). (see Figure 19).
2. Adjust the Driving Console angle so you can reach and hold it comfortably with a clear view of the display area (2).
3. Tighten the adjustment lever once you're done (3).

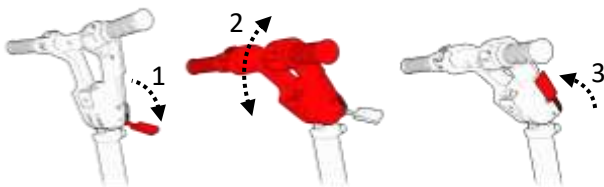

Figure 19 Driving console tilt adjustment

## Seat height adjustment

### REQUIRES TOOLS

Adjusting seat height must be performed only by certified technician to prevent injury and damage.

Although ATTO's seat is thin and stylish, it was designed to provide comfort and safety and can be adjusted according to user's preferences. The seat mechanism can be locked at one of four fixed heights. To adjust seat height please follow the following steps, no tools needed:

1. ATTO must be in opened position in order to adjust seat height. Lift the seat to upright position, locate the seat height adjustment cover at the seat base right under the seat pivots and remove it by pressing on 2 side spots with a screwdriver (see Figure 20, Step 1).

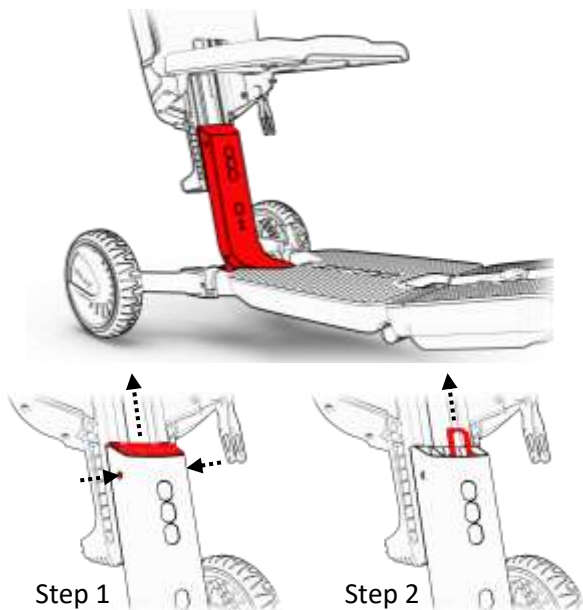

Figure 20 Seat height cover

2. Under the cover you will find a metal bracket that has to be removed. Hold the bracket between your fingers and lift it out. Remember the bracket position to make it easier to put it back in place again (see Figure 20, Step 2).

3. Once the bracket has been removed you should be able to remove the bulky metal pin (located in one of the three adjustment holes) holding the seat in its place. Remove the pin while holding the seat with your other hand (see Figure 21, Step 3).

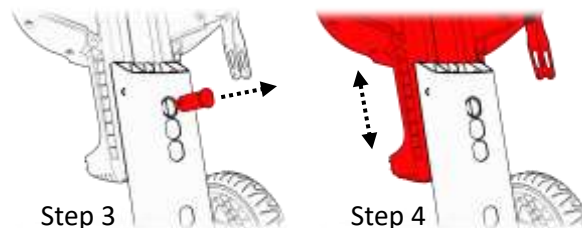

Figure 21 Seat height adjustment holes

4. Now you can adjust the seat to any of the four holes height and reinsert the pin to hold it in place (see Figure 21, Step 4).
5. Reinsert the metal bracket and the cover.

**⚠ WARNING**

When the seat is in its highest position, the ATTO will be more inclined to tip over.

## Tiller angle adjustment

### REQUIRES TOOLS

The tiller angle adjustment must be done by certified technician only, to prevent injury and damage.

The Steering Rod (tiller) angle can be adjusted in one of two positions according to user comfort. The default position will be adequate for most users, larger users may want the Steering Rod further away from their body for more space. In order to adjust the angle, you need a 4 mm Allen wrench (hex key).

1. ATTO must be in the opened position in order to adjust the tiller angle. Once opened, locate and release the two Alan (hex) screws shown in Figure 22 while holding the tiller in upright position (you need to hold the tiller to prevent it from falling while releasing the screws).
2. Move the tiller into the desired position and tighten the two screws back again using a thread locker (such as Loctite).

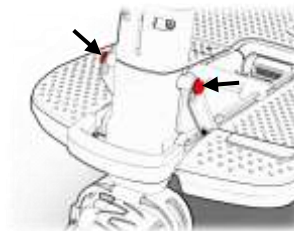

Figure 22 Steering Rod angle adjustment screws

## Driving Console

The Driving Console (your ATTO's dashboard) contains all the controls and display needed for operating your ATTO while driving.



Figure 23 Driving Console overview

die u hier wilt weergeven.

## ON/OFF and speed control buttons

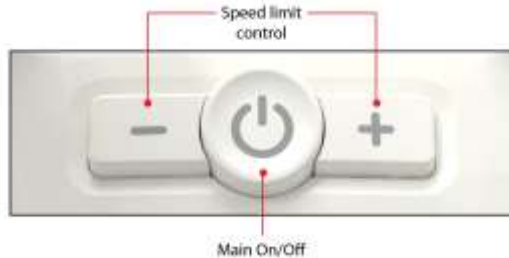

Figure 24 On/Off and speed control

- A. The On/Off button is located at the center of the Driving Console below the display panel. To turn ATTO on press and hold the button until ATTO starts.
- B. The two buttons on the sides of the ON/OFF switch marked with "+" and "-" are your speed limit control. Along with the number shown on the display panel, they allow you to set the maximum speed ATTO will develop at full throttle. While ATTO is not moving, Click the

"+" button to increase the speed and the "-" button to decrease the speed.

### **⚠ WARNING**

When driving in crowded places and near obstacles, use extra care and reduce the maximum speed to a limit allowing you to control your ATTO without presenting a risk to other people and to yourself.

## Display panel

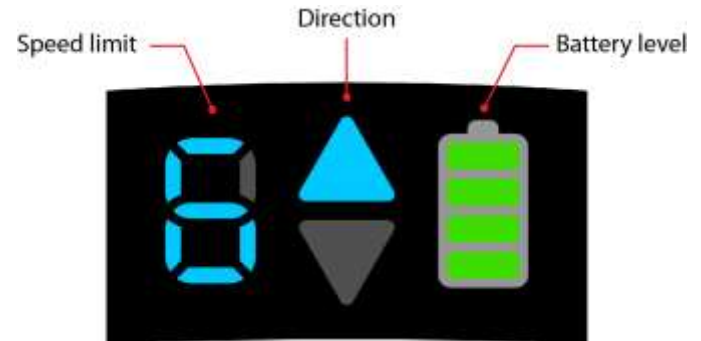

---

Figure 25 Display Panel

---

die u hier wilt weergeven.

**Battery level meter** – When ATTO power is ON the battery meter indicates the approximate battery charge level. As with all Li-ion batteries, the charge level indication is accurate only when the battery is fully charged. All other indications are approximate and intended to give you a rough idea of the battery charge level. Please refer to the "Specification" chapter in this Owner's Manual for more information on your battery range.

**NOTE**

Your ATTO will automatically turn itself off if the battery output falls below operation voltage.

**Direction mode** – ATTO can drive both forward and backward. The current driving direction is shown on the display panel by an arrow pointing forward or backward, depending on user's selection. To switch the driving direction, press on the direction button located near the left hand grip.

## Throttle

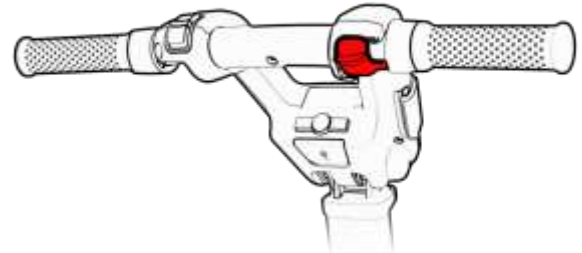

Figure 26 Driving Throttle

The throttle is used for driving and controlling the driving speed. Place your thumb on the throttle lever and press it down to accelerate. To decelerate, release the throttle lever to your level of comfort. To bring the ATTO to a complete stop simply remove your thumb from the lever which will set the lever to its "off" position, bringing the ATTO to a halt after 1.2 meter.

## Reverse and horn buttons



Figure 27 Reverse and horn buttons

- A. ATTO is equipped with a driving direction button. Press on the button to change the driving direction. Once the driving direction has changed, ATTO will sound a single beep when in forward driving mode, and a double beep when in reverse driving mode. In addition, a large arrow on the display panel will indicate the current driving mode. When ATTO is turned on it is always in Forward driving mode.
- B. Press the horn button to sound the horn. Always use the horn when needed to prevent accident or injury.

### **⚠ WARNING**

Always bring the ATTO to a full stop before changing the driving direction.

## USB port

ATTO is equipped with a general USB charging port providing up to 1A charging current. If an error occurred, the port is disabled, and the ATTO will operate as normal. The error will be reset after restarting of the ATTO's controller (power off/on cycle).

## Display Dimming

Pressing the "+" and "-" buttons simultaneously will toggle the dimming option.

## Beep sounds

Beeps caused by pressing buttons may be enabled or disabled. To Enable, press the "+" and "Horn" buttons simultaneously. To Mute the beeps, press the "-" and "Horn" buttons simultaneously (horn is always active).



die u hier wilt weergeven.

## Handle bar grips



Figure 28 Handlebar grips

There are two grips on the handlebar, one on each side. To change the grips from folded position to drive position simply lift the grip around its pivot and it will lock itself in the open position. To fold it back again (only when you are about to fold ATTO), simply pull the grip away from the handlebar and down to an angle of nearly 90 degrees where it will automatically lock itself in the new position.

### PINCH POINT

Be careful of pinch points near the grip hinge. To prevent injury, keep your fingers away from metal

parts and hold the grip and the handlebar only in non-exposed areas covered with plastic and rubber.

## Getting on ATTO

- Verify that the ATTO is turned off.
- Verify that the ATTO is fully opened and secured. See the "Opening" section of this Owner's Manual.
- Carefully place one foot on the approximate center of the deck and seat yourself comfortably and securely on the seat.

### WARNING

Do not lean on the handlebar tiller for support during stepping on or off the ATTO. The handlebar might unintentionally move and cause you to lose your balance which could result in personal injury.

### WARNING

Never step on or off the ATTO using the seat or the seat backrest for support. The seat back may fold down and may cause you to lose your balance, which could result in personal injury.

## Getting off ATTO

- Verify that the power is turned off.
- Carefully place one foot on the ground, transfer your weight to that leg, and slowly come to a standing position.
- Step away from the ATTO.

## Driving

### NOTE

#### INSPECTIONS PRIOR TO USING YOUR ATTO:

1. Please check that the battery is in its place and verify it is locked and not protruding off the surface.

2. Please check that the battery is fully charged or has enough capacity to carry you to your desired destination.
3. Verify that the freewheel lever is in locked position.
4. Verify that all locking parts are in fully opened position and locked in place.

## Turning ATTO on

Press and hold the “On” button to turn ATTO on. All lights will come on momentarily and then the following information will be indicated:

- Set maximum speed
- Forward driving direction (default)
- Battery charge level status

See Figure 29 Typical display after turning on.

die u hier wilt weergeven.



Figure 29 Typical display after turning on

- We recommend that you select a maximum speed setting (using the "+" and "-" buttons near the On/Off switch) at which you feel comfortable, safe, and in control of your ATTO.
- Make sure that you are seated safely and properly on your ATTO.
- For your first driving sessions, make sure that your ATTO starts out on a level surface and that you will continue driving on a level surface.

**⚠ WARNING**

- Never touch the Freewheel/brake release lever while driving.
- Do not bend, lean, or reach for objects if you must pick them up from the ATTO deck or from either side of the ATTO.
- Movements may change your center of gravity and the weight distribution of the ATTO and cause your ATTO to tip over, possibly resulting in personal injury.
- Never switch the ATTO to the Freewheel mode when somebody is sitting on it.
- For proper operation, the Freewheel/brake release lever should always be securely engaged.
- Always bring your ATTO to a complete stop before stepping up or down from the ATTO.

## Forward driving

- Place your hands on the handgrips. Move the tiller to the center position to drive straight forward.
- Make sure you are in forward drive mode by looking at the Direction Arrow on the display. If the arrow points forward (away from your body to the

front) then you are in Forward Mode. If the arrow points backwards in the direction of your body than you should click the Direction Button until you hear one beep and making sure the Direction Arrow is pointing forward.

- Use your right thumb to operate the drive throttle. Press the throttle lightly to move forward.
- Increase the pressure applied by your thumb to increase your speed.
- To stop ATTO, release all pressure on the throttle. The throttle will automatically return to the upper (off) position and your ATTO will come to a gradual stop. **NOTE:** Always bring your ATTO to a full stop before changing direction from forward to reverse, or from reverse to forward.

## Reverse driving

- Place your hands on the handgrips.
- Use one of your left fingers to press the direction button located on the left side of the Driving Console.
- You should hear a double beep confirming you are now driving backwards. If you hear a single beep

you are in forward drive mode and should click the direction button again.

- Use your right thumb to operate the drive throttle. Press the throttle lightly to move backwards.
- Increase the pressure applied by your thumb to increase your reverse speed.
- To stop ATTO, release all pressure on the throttle. The throttle will automatically return to the upper (off) position and your ATTO will come to a gradual stop.
- You should know that for safety reasons ATTO's speed in reverse is slower than the maximum speed set on the speed control dial.

## Stopping

Just let go of the drive throttle, which will automatically return to the upper (off). The ATTO automatically brakes using the regenerative brake. This will be followed by entering the ATTO into "parking" mode using the electro-mechanical brake.

## Emergency braking

In case you must stop, and you have released the drive throttle, but your ATTO continues to move, press the On/Off switch until the ATTO turns off and stops.

## Steering

- Steering your ATTO is easy and intuitive.
- With both hands on the handgrips of the tiller, turn the tiller to the right or to the left to change the moving direction accordingly.
- Make certain to maintain sufficient clearance when turning your ATTO so that the rear wheels will clear any obstacle.

### WARNING

Turning too sharply around a corner can cause the ATTO to tip over. Avoid this danger by steering a wide arc around corners and obstacles. Also, to avoid the risk of tipping over, reduce speed before negotiating any turns.

## Steering in a tight spot

If you must steer in a tight spot, such as entering a doorway or when turning around:

- Bring your ATTO to a full stop.
- Turn the speed control to the slowest speed setting.
- Turn the tiller to the direction in which you wish to drive.
- Press gently on the thumb throttle and slowly turn your ATTO.

## Steering in Reverse

Backing up your ATTO requires special attention to what you are doing:

- Use a left finger to click the direction button. You should hear a double beep confirming you are now driving backwards.
- Turn the tiller in the direction in which you wish to drive backwards.

- Note that for safety reasons ATTO's speed in reverse is slower than the maximum speed set on the speed control dial.

## Driving on slopes

### **▲ WARNING**

Stopping distance on slopes can be significantly greater than on level ground

More and more buildings have ramps with specified degrees of inclination, designed for easy and safe access. Some ramps may have switchbacks (180 degrees turn) that require you to have good cornering skills on your ATTO.

- Proceed with extreme caution as you approach the downgrade of a ramp or other incline.
- Take wide swings with your ATTO around any tight corners. If you do that, the ATTO's rear wheels will follow a wide arc, not cut the corner short, and not bump into or get hung up on any railing corners.

- When driving down a ramp, keep ATTO's speed set to the slowest speed setting to ensure a safely controlled descent.
- Avoid sudden stops and starts.

When climbing an incline, try to keep ATTO moving. If you must stop, start up again slowly, and then accelerate cautiously. When driving down an incline, do so by adjustment the speed to the slowest setting and driving in the forward direction only. If your ATTO starts to move down the incline faster than you anticipated or desired, allow it to come to a complete stop by releasing the throttle. Then push the throttle forward slightly to ensure a safely controlled descent.

### **▲ WARNING**

When climbing an incline, do not zigzag or drive at an angle up the face of the incline. Drive your ATTO straight up the incline. This greatly reduces the possibility of tipping over or falling. Always exercise extreme caution when negotiating an incline.

### **▲ WARNING**

die u hier wilt weergeven.

Do not drive your ATTO across the side of an incline or diagonally up or down an incline; Avoid stopping, as much as possible, while driving up or down an incline.

**⚠ WARNING**

You should not travel up or down a potentially hazardous incline (i.e., areas covered with snow, ice, cut grass, or wet leaves).

**⚠ WARNING**

When on any sort of an incline or decline, never place the ATTO in freewheel mode while seated on it or standing next to it.

**⚠ WARNING**

Even though your ATTO is capable of climbing slopes greater than that illustrated in Figure 30, do not, under any circumstances, exceed the incline

guidelines or any other specifications presented in this manual. Doing so could cause your ATTO to become unstable, resulting in personal injury and/or damage to your ATTO.

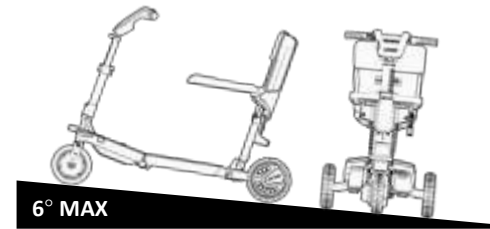

Figure 30 Maximum recommended incline angle

**⚠ WARNING**

Any attempt to climb or descend a slope steeper than what is shown in Figure 30 may make ATTO unstable and cause it to tip over, resulting in personal injury.

When approaching an incline, it is best to lean forward (see Figure 31 and Figure 32). This shifts the center of gravity of you and your ATTO toward the front of the ATTO for improved stability.



Figure 31 Normal driving position



Figure 32 Shifts center of gravity

## Turning corners

Turning at high speed may cause a tipping over. Factors affecting the possibility of tipping over include turning speed, steering angle (how sharply you are turning the steering tiller), uneven road surfaces, inclined road surfaces, a transition from low grip area to high grip area (as moving from a grass surface to a paved surface - especially at high speed while turning), and abrupt changes of direction. High speed turning is not recommended. If you feel you are about to tip over while turning, reduce speed and steering angle (i.e., make the turn wider) to prevent your ATTO from tipping over.

### **⚠ WARNING**

When you turn a sharp corner, reduce speed. When you use the ATTO at a high speed, do not turn sharply. This will reduce the risk of overturning and falling. Always exercise discretion when taking a turn to avoid injury and damage to property.



die u hier wilt weergeven.

## Folding (closing)

1. Make sure ATTO is on flat ground before folding it.

### PINCH POINT

Operations described in this chapter are done near and around pinching points. Be careful and follow instructions to prevent injury. Make sure your fingers are away from moving parts that may be closing gaps while moving.

2. Fold both sides of the handle bar (see Figure 33).

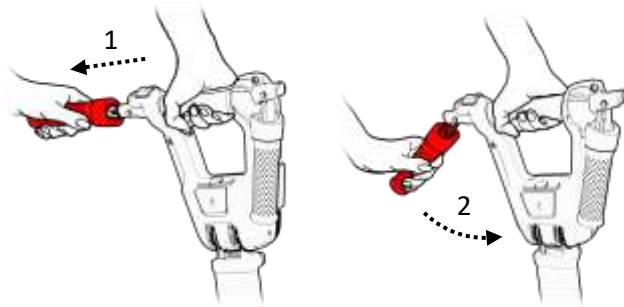

Figure 33

3. Release the secure lever of the back handle (1) and bring the handle to 100 degrees position (2). Allow the seat to slide down until it clicks in place (3). (See Figures 34 and 35).

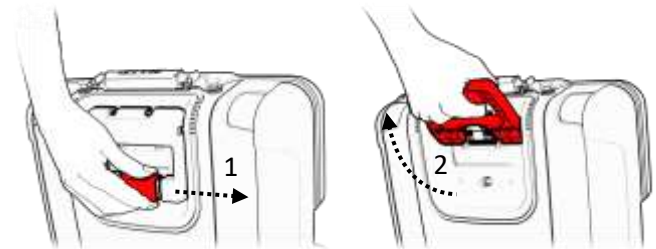
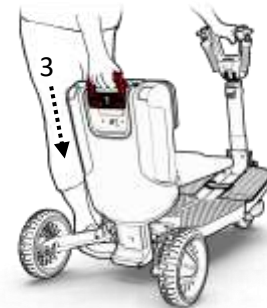

Figure 34



---

Figure 35

---

4. Push the back of the chair forwards until it clicks (see Figure 36).

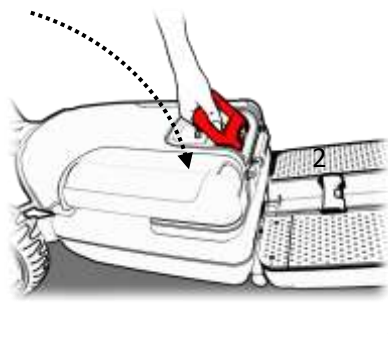

---

Figure 36

---

5. Use one hand to keep the rod upright. Using your other hand, release the front lever (1) In case the front lever requires too much force to operate, you should apply horizontal pressure on the main handle towards the front of the ATTO (2). This will release the pressure on the front lever and will make it easier to open (3). (see Figure 37).

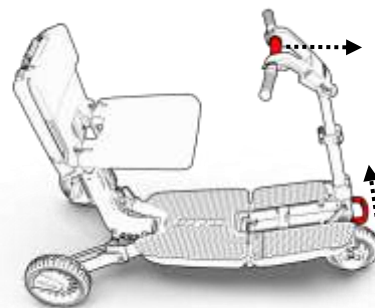
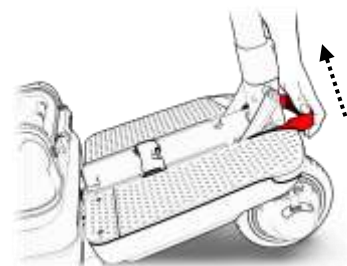

---

Figure 37

---

Switch hands. Use one hand to keep the rod upright and use your other hand to lift the main handle (see Figure 38).

die u hier wilt weergeven.

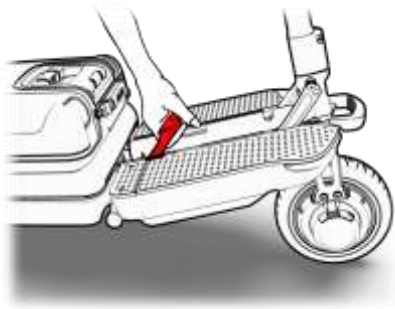

Figure 38

6. Using the main handle to pull the center upwards and towards the rod (1) until it clicks and locks in place (2). (See Figure 39).

**⚠ PINCH POINT**

Be careful not to pinch your finger between the chassis. This area is a pinch point and requires your full attention.

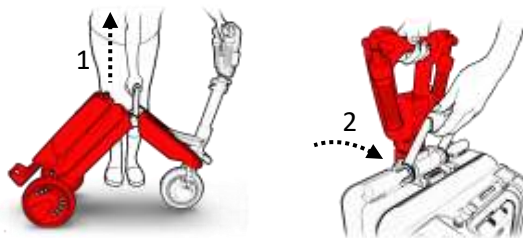

Figure 39

7. Pull the rod lever (1) to adjust the height of the handle bar to the lowest position and bring the lever back to the secure position (2). (See Figure 40).

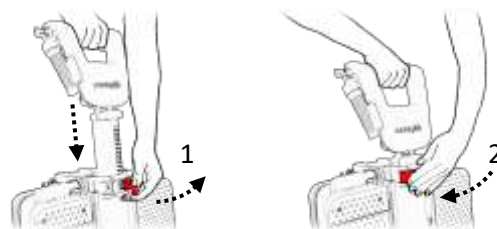

Figure 40

8. Release the adjustment lever of the handle bar (1) and bring the handle bar to a horizontal position (2). Then bring the lever back to secure position (3). (see Figure 41).

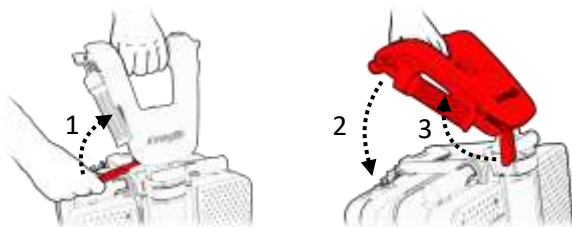

Figure 41

below. Lifting ATTO as a whole may be too heavy and may cause injury or damage.

ATTO's front and rear halves (chassis) can be easily and effortlessly separated in only a few seconds by operating a knob and two handles. The same technique applies to putting the two halves back together. This is very useful when storing ATTO in the trunk or in an airplane's overhead bins.

1. Make sure the handle bar is secured at an upright position (see Figure 42).

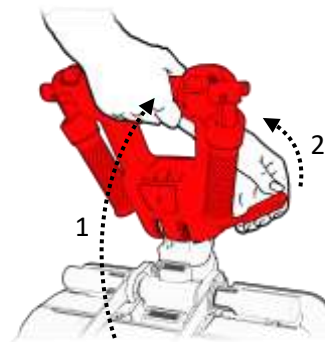

Figure 42

## Separating the chassis

### **⚠ WARNING**

Lifting ATTO by yourself may be challenging for some people and therefore not recommended. If you have another person to assist you, we suggest lifting the product together. If you need to lift ATTO alone, you can separate ATTO into two segments as described

die u hier wilt weergeven.

---

2. Open both separation levers (see Figure 43). In case the separation levers require too much force to operate, you should apply horizontal pressure on the driving console towards the center of the ATTO. This will release the pressure on the separation levers and will make them easier to open.

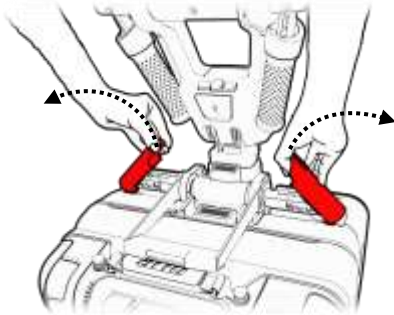

---

Figure 43

---

3. Hold the handle bar with one hand and press the central release button with the second hand until it clicks (see Figure 44).

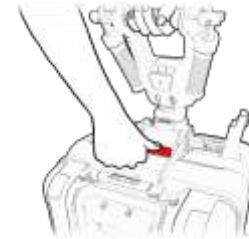

---

Figure 44

---

4. Carry the front chassis from the handle bar and separate from the back chassis (see Figure 45).



---

Figure 45

---

## Lifting separated chassis

1. Once the two chassis have been separated and you are ready to lift them, for instance into your car trunk, make sure both chassis are set flat on the ground where they will not be an obstacle to you or to others.
2. Grab the one of the chassis from designated handles and carry it to its destination (See Figure 46).
3. Repeat the previous step on the other chassis.
4. Lay the chassis flat and secure them with straps (or other ways) to insure safety and damage free transportation.

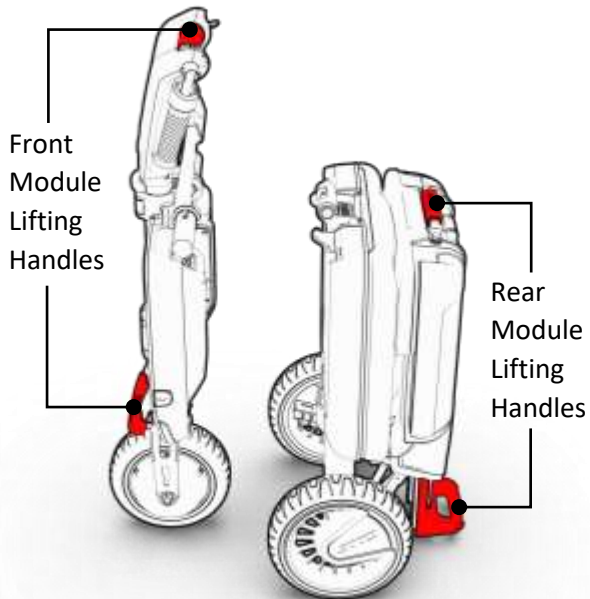

---

Figure 46 – lifting points

---

## Connecting the chassis

1. Make sure the handle bar is secured at an upright position (see Figure 47).



---

Figure 47

---

Place the back chassis vertically. Hold the front chassis from the handle bar and bring it towards the back chassis (see Figure 48).



Figure 48

- Bring the two parts together. Use the hanging hooks (see Figure 49) to locate the two ends properly. At this point the central release button will click.

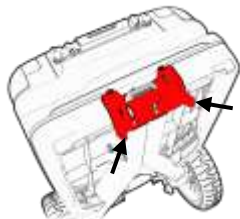

Figure 49

- Close the two separation levers until they click (see Figure 50). In case the separation levers require too much force to operate, you should apply horizontal pressure on the driving console handle towards the center of the ATTO. This will release the pressure on the separation levers and will make them easier to open.

**NOTE:** DO NOT try to open ATTO for driving before the two levers are secured in the downwards

position

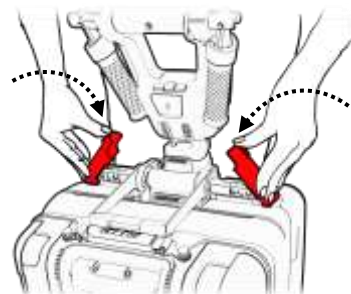

Figure 50

## Freewheel

ATTO is equipped with a manual freewheel lever, which when pushed to “N” state it is in freewheel mode and allows the ATTO to be pushed.

### **⚠ WARNING**

When ATTO is in freewheel mode, the braking system is disengaged, and ATTO will move freely with



die u hier wilt weergeven.

very little force. This can cause injury and property damage to anyone and anything nearby.

- Change to freewheel mode only on a level surface.
- Ensure ATTO's power is turned off.
- Never sit on ATTO while handling the freewheel lever.

#### **⚠ WARNING**

After you have finished pushing your ATTO, always lock the brakes by changing to non-freewheel mode.

### Operating the freewheel

In case the battery dies or ATTO is not driving, ATTO may be rolled manually. This will require releasing the mechanic auto-brake of the front wheel pushing the free wheel lever towards mode "N" (see Figure 51).



---

Figure 51 Releasing the freewheel

---

Before driving ATTO again, make sure the freewheel lever is pushed backwards to mode "D" (see Figure 52).



---

Figure 52 Securing the freewheel

---

## Battery and charger

ATTO's charger is a small yet smart and powerful charger with the ability to connect to any electrical grid rating 110VAC – 240VAC. It is fully approved and safe to use.

- When connecting the charger, connect the DC charging cord to the battery charge plug before connecting the charger AC cord to the electrical outlet.

- When disconnecting the charger, always do so in reverse order of the connecting procedure.



---

Figure 53 ATTO's Li-ion Battery

---



---

Figure 54 ATTO's Charger

---

die u hier wilt weergeven.

## Installing the battery

To install the battery, insert first the back end of the battery (1) and then push the front until the battery clicks and locks in place (2). (See Figure 55).

### NOTE

Make sure the battery is properly connected before folding ATTO or turning it on.

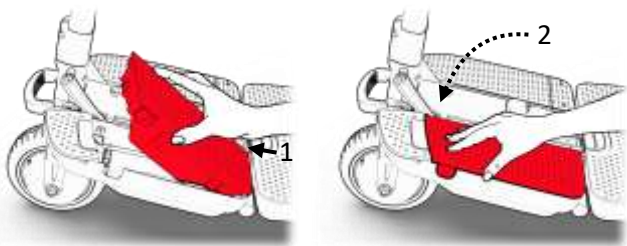

Figure 55

## Removing the battery

Identify the battery release button highlighted in red frame in Figure 56.

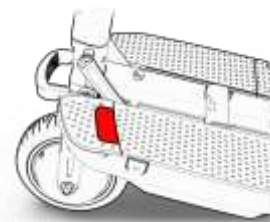

Figure 56 - battery release button

To remove the battery from ATTO, press the release button (1) and pull the battery out (2). (see Figure 57).

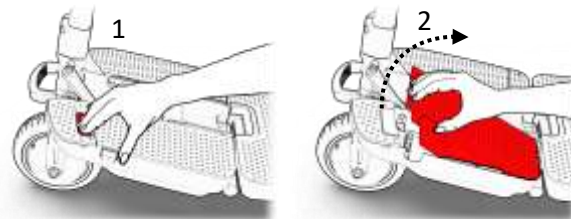

Figure 57

Use the handle for carrying the battery when removed from ATTO (see Figure 58).



Figure 58

#### **⚠ WARNING**

- NEVER attempt to recharge the batteries by attaching cables directly to the battery terminals.
- DO NOT attempt to recharge the battery and operate ATTO at the same time.
- DO NOT attempt to recharge the battery when ATTO has been exposed to any type of moisture.
- DO NOT attempt to recharge the battery when ATTO is outside.
- DO NOT sit on ATTO while recharging the battery.

#### **⚠ WARNING**

- New battery **MUST** be fully charged prior to initial use of ATTO. **ALWAYS** fully charge new battery before initial use or battery life will be reduced.
- As a general rule, you should charge your battery at 60% of full charge before placing in storage for long period of time.
- Only use a charger approved by MovingLife.
- Use of improper extension cord for the charger could result in risk of fire and electric shock.

Charging the battery can be done on board and off board, meaning you can connect the charger when the battery is in its place inside ATTO or when it is taken out of ATTO.

### Charging the battery

#### **📌 NOTE**

- a. The battery should not be emptied. To maintain good battery state and maximize its

die u hier wilt weergeven.

---

life span always charge the battery when the battery meter reaches 2 green lines.

- b. Before placing the battery for a long period of time make sure to charge it at about 60% of full charge.

1. Connect the charger to the electric socket. The Green LED should turn green to indicate the charger is properly connected to the socket.
2. Connect the other end of the charger to ATTO's battery. The charger LED will turn red to indicate the battery is not fully charged and that charging is taking place.
3. When the battery is fully charged, the LED will turn green. This may take up to 6 hours. Once charging is complete, disconnect the charger from the wall socket and then disconnect the battery from the charger.

#### **NOTE**

Battery can be charged either when connected to ATTO or out of ATTO.

## Maximizing battery's life time

### **WARNING**





Always keep batteries in cool dry conditions to prevent damage to the battery and surrounding equipment.





## Error Codes

When ATTO's smart controller detects a problem, you will be notified by a letter (A-Z) shown on the Driving Console display.

Some errors are not significant and do not affect your ability to use ATTO such as a call for service, while other errors are severe and critical enough to cause ATTO to stop operating, all for your own safety.

The following table details error codes and their meanings:

Code	Severity	Explanation and what to do
	Low	USB port reports an error. Disconnect any device. Check if port is wet. Restart ATTO.
	Low	Throttle may be pressed while ATTO is turned on. Release the throttle. If problem persists restarts ATTO.
	High	Motor Sensors malfunction. Contact support.
	Low	Motor reports an overload. Shutdown ATTO, wait 10 minutes and restart.
	Low	Controller is over heated. Shutdown ATTO, wait 10 minutes and restart.

Code	Severity	Explanation and what to do
	High	Internal communication error occurred do to wiring or internal electric problem. Contact support.
	High	Internal electric problem. Contact support.
	Low	Controller sensed over or under Voltage. Stop ATTO and restart.
	Low	Blinking 'F'. Freewheel handle is in Neutral mode. Turn it to Drive mode to turn on Atto.

die u hier wilt weergeven.

---

**NOTE**

Error codes may be updated in future software versions.

## TRANSPORTING ATTO

ATTO can be effortlessly transported in many types of vehicles, on land, sea or by air.

Transport of ATTO on commercial aircraft is subject to federal regulations and airline policy. Please consult your airline prior to your flight to ensure your ATTO and its lithium-ion battery is permitted.

To transport ATTO:

- ◆ For safety reasons, remove the battery and place it in a safe location.
- ◆ Make sure it is fully closed.
- ◆ To prevent injury and damage, secure ATTO in a way that will prevent it from moving around or shaking.
- ◆ Cover or otherwise secure the tiller and handlebar to prevent it from being damaged due to moving objects or by ATTO shifting around during transport.

To transport ATTO in a car please see the “Separating the chassis” chapter in this Owner’s Manual.

### **⚠ WARNING**

- If your ATTO and its components are not properly and securely stowed, the ATTO or components may shift around while driving causing injury or damage.
- If the ATTO is transported in a vehicle when fully assembled and in open position, no one should sit on the ATTO during loading and transport.
- If you use an external lifting system, be sure to secure your ATTO as it could fall off the lift.

### **ℹ NOTE**

When transporting ATTO, make sure it is always in an environment within the allowed specifications for humidity and temperature.



# TROUBLESHOOTING

## If your ATTO does not operate

1. IF YOU TURN ATTO ON AND IT IMMEDIATELY SHUTS ITSELF, PLEASE CHECK TO ENSURE THE FREEWHEEL LEVER IS IN DRIVING MODE.
2. MAKE SURE THE CHARGER IS NOT CONNECTED TO YOUR ATTO.
3. Check the battery, is it charged? If you are not sure, you can connect it to the charger and wait for the green LED.  
Once you are sure the battery is not empty;
4. Make sure the battery is properly placed in its battery housing on the ATTO, and that there is no foreign material such as paper or dirt interfering with the electrical contact between the battery and its connector.  
If that's ok;
5. Check the fuse; if it is blown, replace it following the procedure in the "Maintenance"

chapter of this Owner's Manual. Once you made sure the fuse is good;

6. Try to turn the ATTO on by pressing the On/Off button for at least 2 seconds. If the ATTO does not turn on please contact an authorized MovingLife dealer.

## ATTO is ON but does not move

Start by checking the freewheel lever; make sure it is in locked position as described in the "Operation" chapter of this Owner's Manual.

## Charging problems

If batteries fail to charge within 12 hours:

- Check the battery connections.
- It may be necessary to have the batteries checked and perhaps replaced by an authorized MovingLife dealer.
- It may be necessary to have the charger tested.

**NOTE:** ATTO's battery can be charged while it is installed on the ATTO or when it is removed from the ATTO.

**⚠ WARNING**

Do not leave the battery pack and charger plugged in for more than 12 hours. Damage to the battery pack and a hazardous condition may result.

# MAINTENANCE

ATTO's expected service life is 10 years and it will extend much longer provided care and maintenance procedures are carefully followed.

Please follow the maintenance procedures whenever needed or at least once a year.

Replacement parts are available from MovingLife and authorized service facilities (See back cover for details).

## Electrical fuse

Your ATTO Battery has a protecting fuse at the bottom of the battery pack (see Figure 63).

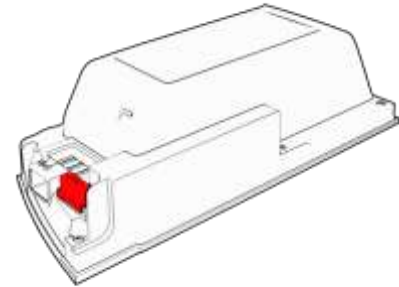

---

Figure 63 Fuse location

---

### Possible causes for the fuse to blow

The fuse is designed to protect the battery from over charging/discharging. You should check the condition of the fuse if:

- The battery is not charging.
- A charged battery is connected to ATTO but ATTO does not turn on.
- ATTO has turned off unexpectedly during operation.

## Replacing a blown fuse

To check the fuse (see Figure 65):

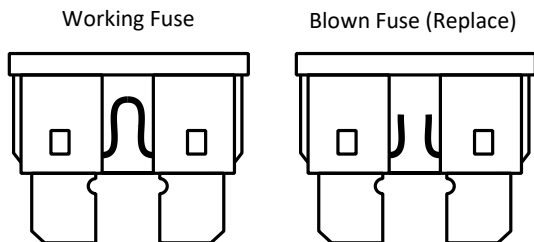

Figure 64 Identifying fuse condition

- Remove the battery and place it on a secure surface such as a table, with its bottom facing up.
- Remove the fuse plastic cover.
- Pull out the fuse.

Examine the fuse to see if it is blown. A blown fuse has a gap in the wire. In case it is blown (see Figure 64), replace it with a new fuse blade type ATO or ATC, Green (30A).

Once a new fuse has been placed please remember to place the plastic cover back in its place (Figure 65).

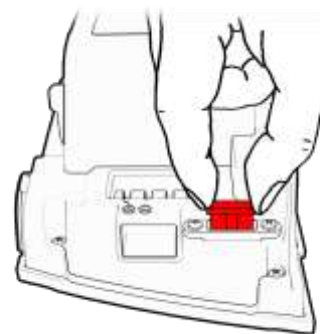

Figure 65 Replacing a blown fuse

### **⚠ WARNING**

Never soak your ATTO in any liquid. This may cause personal injury and/or damage to your ATTO.

### **📌 NOTE**

If the fuse continues to blow, an underlying electrical fault needs professional attention. Please contact an authorized MovingLife dealer.

die u hier wilt weergeven.

---

**NOTE**

Do not replace the fuse repeatedly. You must correct the underlying problem. Failure to correct the problem could cause injury or damage and will void the warranty.

**REQUIRES TOOLS**

Do not attempt electrical repairs. Consult MovingLife or your authorized MovingLife dealer.

## Wheels and Tires

Your ATTO is equipped with one front motor with solid tire and two rear wheels with solid tires. This means that there is no air in any of the tires. The tires are filled with foam and you will never have a flat tire even if you puncture the tire. If for any reason there is a need to replace a tire due to erosion or damage, please contact an authorized MovingLife dealer.

## Lubrication

There are two lubrication areas where a light spray of lubricant should be applied every six months or more rapidly if opening and closing ATTO becomes more difficult to perform (you may use other light lubricant as long as they are not sticky or corrosive on aluminum and plastics).

Lubrication points are shown in Figure 66:

1. Seat post including tracks.
2. Wheel shafts.

Clean the areas to be lubricated with clean cloth leaving no fibers, sand or dust on the ATTO. Once you are done lubricating and testing the ATTO for proper and easy operation, clean the entire surrounding parts from lubricant residues.

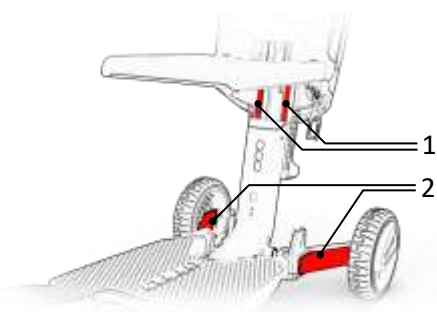

Figure 66

All the bearings on your ATTO are permanently lubricated and sealed and therefore no lubrication is required.

## Battery

### **⚠ WARNING**

ATTO's battery holds a substantial amount of power. Shorting of the terminals can result in burns or other injuries and in damage to the battery and to the electronic components of your ATTO. Always use care and caution when handling the battery.

## Battery & Charging

- These batteries are maintenance-free.
- Your ATTO is being equipped with Li-ion battery, which does not have a “memory” issue and therefore it is not necessary to completely discharge the battery before recharging it.
- If you are not going to use your ATTO for an extended period of time, charge the batteries to 60% of full charge before storing your ATTO. The batteries can be left unmaintained for up to 6 months if they are properly charged and kept at room temperature approximately 22 °C (~ 72° F).
- If you have not used your ATTO for more than one month, make sure that you charge the batteries on the night before you are going to use your ATTO. This will ensure that you start operating your ATTO with a fully charged battery.
- There is no danger of spillage or leakage, so these batteries are safe to transport on aircrafts, busses, trains, etc.
- Following the procedures set out in this Owner's Manual will extend the life of your batteries.

die u hier wilt weergeven.

---

- If electrical terminals on the ATTO become corroded, they need to be cleaned by a certified MovingLife technician.
- If battery terminals become corroded, it has to be replaced with a new battery.

**⚠ WARNING**

FIRE HAZARD! Do not cover the battery charger and ventilation slot while charging your battery. Only use the battery charger in well-ventilated areas.

## Cleaning, body care

ATTO's body is made of ABS parts, a durable plastic with integrated paint. To help ATTO retain high gloss you may clean it using clean cloth moistened with water.

## Storage

If you plan to not use your ATTO for an extended period, it is best to:

- Remove the battery pack from the ATTO.
- Store your ATTO in ambient, dry environment.
- Avoid storing your ATTO where it will be exposed to temperature extremes.

**⚠ WARNING**

Always protect batteries from freezing temperatures and never charge a frozen battery. This damages the battery and can cause personal injury.

To use ATTO after an extended period of storage:

- Open ATTO if it was closed / folded during storage.
- Visually inspect all user adjustment levers, look for possible damage in plastic and metal parts, and ensure all moving parts works and has no evidence of corrosion. If you do find a part which do not

function as expected or has corrosion, call a certified technician for advice how to continue.

- Insert the battery and turn ATTO on.
- Check that the display and all buttons work as expected. If you find no problems you may use ATTO, otherwise call a certified MovingLife technician.

## Disposal

Your ATTO must be disposed of according to applicable local and national statutory regulations. Contact your local waste disposal agency or authorized MovingLife dealer for information on proper disposal of packaging, metal frame components, plastic components, electronics, and battery.

## Spare parts

Spare parts can be purchased directly from MovingLife or from a local representative (check back cover for dealer contact information).



die u hier wilt weergeven.

## SPECIFICATIONS

### Model

ATTO Mobility Scooter Type I

### Speed

ATTO's maximum speed (limited by software) is 6.4 km/h (4 mph). Maximum driving speed can be set to one of the presets by simply clicking a button and watching the indication on ATTO's clear view display.

### Weight

Part	Kg	Lbs
Front half	12	26.4
Rear half	17	37.5
Assembled *	29	63.9
Battery	1.85	4.1

\* Without the battery

### Weight Capacity

Maximum user weight is 100 Kg (220 Lbs.).

### Dimensions

When folded, ATTO is the most compact mobility scooter in the world. Nevertheless, when open and ready to drive, ATTO is the largest and most comfortable in its category.

ATTO's dimensions, units in cm (inch):

Part	Height	Length	Width
Trolley mode	72 (28)	39 (15.3)	42 (16.5)
Drive mode	90 (35)	120 (47)	56 (22)

### Ground clearance

ATTO's minimum ground clearance is 10 cm (4").

## Front wheel drive motor

To allow smooth and continuous drive over many years and large distances, we developed a unique, fully customized, brushless, permanent magnet DC motor, combining solid core and powerful gear along with robust braking mechanism. Via sophisticated software algorithms the motor utilizes modern reverse charging techniques for deceleration and stopping providing smooth driving experience.

## Tires

PU filled non-pneumatic tires.

## Battery

ATTO uses a powerful, yet compact, lightweight advanced 48 Volts Lithium-Ion battery. Weighing only 2 kg (4.4 lbs.), the battery allows for more than 16 km (10 miles) of continuous driving while requiring only 4 hours (on average) to fully charge. You can charge ATTO on-board and off-board, meaning that you can (but do not have to), take the battery off the ATTO in order to charge it. Removing the battery is as easy as pressing a

button. Reinstalling the battery is as easy as putting it back in place.

## Operating range

Battery model	Metric	Imperial
250 W/h	16 Km	10 Mile

## Charger

UL and CE approved Charger with self-shutdown functionality for safety and extended battery and charger lifetime.

## Controller

Unique Brushless DC Motor Controller. Genuine product by MovingLife Ltd. Unique LED Display with options of Dimming and a clear error display. Internal data and error log for easy maintenance and traceability. MovingLife Controller provides 10A continues working current with maximum of 30A peak.

## Turning Radius

1.35 meters (53").

die u hier wilt weergeven.

---

## Freewheel mode

Yes.

## Maximum incline

6 degrees.

## Height Restrictions

Preliminary tests show that a minimum height of 150 cm (5 Feet) is required for safe driving. This is NOT a formal recommendation, we have not concluded the tests yet, and you should check with your medical advisor.

## Environment

ATTO was designed and tested according to strict water resistance IP54 standard, requiring the equipment to be

### **⚠ WARNING**

Owners and operators should always adhere to the following precautions:

- Refrain from modifying the ATTO Mobility Scooter hardware or software in any way.
- Never allow untrained personnel to operate the ATTO Mobility Scooter.
- Always report to MovingLife Ltd authorized representatives only.

water resistant to splash from multiple angles, for a long period of time and at high pressure. After taking a 50 liters shower ATTO continued to work with zero malfunctions, which guarantees resistance to normal outdoor conditions. Nevertheless, we recommend storing ATTO indoor to ensure maximal lifetime of high performance and for safety reasons use it only under dry weather conditions.

## Flammability

ATTO Is designed according to UL94 V-0.

## Responsibility of the Manufacturer

The manufacturer considers itself responsible for the effects on safety, reliability, and performance of the equipment only if:

- Calibration, service and repairs of the ATTO Mobility Scooter are carried out by MovingLife Ltd personnel or anyone authorized by MovingLife Ltd.
- The equipment is used in accordance with instructions for use.

## LIMITED WARRANTY

MovingLife warrants this product to be free from defects in materials and workmanship for **two years** with the exclusions & exceptions specified below.

If within such warranty period, any such product shall be proven defective, such product shall be repaired or replaced at MovingLife's discretion. This warranty does not include any labor or shipping charges incurred in replacement part installation or repair of any such product.

MovingLife's sole obligation and your exclusive remedy under this warranty shall be limited to such repair and/or replacement.

Any part replaced under warranty is warranted to be free from manufacturing defects until expiry of the original ATTO warranty.

The warranty shall not be affected by change of ownership of the ATTO within the warranty period. Such

change of ownership must be registered in the MovingLife's registration database.

For warranty service, please contact the authorized MovingLife dealer where you purchased your ATTO.

Any defects must be reported to a MovingLife authorized workshop as quickly as possible. Your warranty may be invalidated if you continue to drive your ATTO when a fault becomes apparent.

In the event you do not receive satisfactory warranty service, please write directly to MovingLife at the address on the back cover, provide authorized MovingLife dealer's name, address, and date of purchase, indicate the nature of the defect and, if the product or the defect part carries a serial number, indicate the serial number. Do not return products to our factory or shipping center without our written prior consent.

This warranty does not include worldwide warranty service outside the origin country of purchase. Worldwide warranty service can be provided for

additional fee and only in countries where there is active MovingLife distribution, if made possible.

## **WARRANTY EXCLUSIONS & EXCEPTIONS**

- ATTO Battery - one-year limited warranty. Gradual deterioration in battery performance due to not following usage instructions specified in owner's manual or worn out through heavy use is not covered. The ATTO Warranty includes an ATTO Battery Warranty against failures of the high voltage battery as a result of manufacturing defects. The capacity of a lithium-ion high voltage battery naturally decreases over the period of use due to inherent technical reasons (natural wear and tear). Should a capacity check at a MovingLife Authorized Workshop within the warranty period of one-year show that the net battery capacity has dropped below 70% of its original value at the delivery of the new ATTO, the portion below 70% will be regarded as excessive capacity loss.

To maintain your ATTO Battery Warranty, your ATTO must be inspected at the correct service

intervals as recommended by your ATTO local dealer or by MovingLife Authorized dealer.

- ABS plastic
- Seat upholstery
- ATTO tires/tire tubes
- Repairs and/or modifications made to any part of the product or accessories without specific and prior written consent from MovingLife
- Circumstances beyond the control of MovingLife
- Damage caused by: battery malfunction, abuse, misuse, accident, or negligence, improper operation, maintenance, or storage, commercial use or use other than normal
- Labor, service calls, shipping, and other charges incurred for repair of the product
- If the serial number has been removed or defaced

Such evaluation will be solely determined by Moving Life.

Moving Life shall not be liable for any consequential or incidental damages whatsoever.

There is no other express warranty.

die u hier wilt weergeven.

---

Implied warranties, including those of merchantability and fitness for a particular purpose, are limited to one year from the date of original purchase and to the extent permitted by law.

Any and all implied warranties are excluded. This is the exclusive remedy. Liabilities for consequential damages under any and all warranties are excluded.

This warranty gives you specific legal rights and you may also have other legal rights which vary from country/state to country/state.

# CONTACT INFORMATION



## Legal Manufacturer

MovingLife Ltd.

Netzer Sereni 709500 Israel

Tel: +972(73)-391-3999

Email: [info@movinglife.com](mailto:info@movinglife.com)

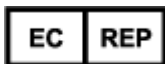

## Authorized representative

Obelis Group Ltd.

Bd Général Wahis, 53,

B-1030 Brussels

Belgium

Authorized service  
facilities label

Serial number label

## US IMPORTER:

MovingLife Inc.

Tour Scotia, 1002 rue Sherbrooke O.

Bureau 1900, Montreal, Quebec, H3A 3L6 Canada

Tel +1(347)761-3317



die u hier wilt weergeven.

---

# Notes



RG-012-ATTO-1

ATTO Owner's Manual  
English

RG-012-ATTO-1 Owners Manual ENG Ver 2.8  
2<sup>nd</sup> Issue - July 2018

Copyright © 2018-2019  
All rights reserved