

NINJA

Please read and follow all instructions in this owner's manual.

The symbols below are used throughout this owner's manual to identify warnings and cautions.



TABLE OF CONTENTS

I. INTRODUCTION.....	3
II. SAFETY.....	4
III. EMI/RFI.....	9
IV. YOUR SCOOTER.....	11
V. BATTERIES AND CHARGING.....	14
VI. INSTALLATION GUIDANCE.....	17
VII. COMFORT ADJUSTMENTS	24
VIII. BASIC TROUBLESHOOTING.....	26
IX. CARE AND MAINTENANCE	27
X. WARRANTY	29

I . INTRODUCTION

Welcome to Cheet. Congratulations on the purchase of your new Cheeta Scooter. Your scooter design combines the most advanced state-of-the-art components with modern, attractive styling. We are sure that the design features and trouble-free operation will add convenience to your daily living and ensure complete satisfaction.

At Cheeta, your safety is the most important to us. Please read and follow all of the instructions in this manual before you attempt to operate your scooter for the first time. These instructions were produced for your benefit. Your understanding of these instructions is essential for the safe operation of your new Cheeta Scooter.

Cheeta is not liable for damage to property or personal injury arising out of the unsafe use of Cheeta Scooter, Cheeta is also not liable for any property damage or personal injury arising out of the failure of any person and/or user to follow the instructions and recommendations set forth in this manual or any other instructions or recommendations contained in other scooter related literature issued by Cheeta or contained on the Cheeta Scooter itself.

To the publication up to, this manual translated the newest technology standard and the product information. We withhold this manual of the explanation and the revision right. It is possible that there will be slight difference between any change of our product and the illustration of the manual the explanation and the product which you have purchased. If you meet any questions which you can't solve while you using the " Scooter (" safely, or while you think according to the instruction and/or the recommendation method which according to the manual provides are unable to carry on the safe operation, you all may seek the help from the local dealer of the CHEETA.

II . SAFETY

GENERAL:

	WARNING! Do not operate your new scooter for the first time without completely reading and understanding this owner's manual.
---	--

Your scooter is a state-of-the-art life-enhancement device designed to increase mobility. Cheeta provides an extensive variety of products to best fit the individual needs of the scooter user, Please be aware that the final selection and purchasing decision regarding the type of scooter to be used is the responsibility of the scooter user who is capable of making such a decision and his/her healthcare professional (i.e., medical doctor, physical therapist, etc.).

The contents of this manual are based on the expectation that a mobility device expert has properly fitted the scooter to the user and has assisted the prescribing healthcare professional and/or the authorized Cheeta Provider in the instruction process for the use of the product,

There are certain situations, including some medical conditions, where the scooter user will need to practice operating the scooter in the

presence of a trained attendant, A trained attendant can be defined as a family member or care professional specially trained in assisting a scooter user in various daily living activities.

As you begin using your scooter during daily activities, you will probably encounter situations in which you will need some practice, Simply take your time and you will soon be in full and confident control as you maneuver through doorways, on and off elevators, up and down ramps, and over moderate terrain.

MODIFICATIONS

Your scooter has been designed and engineered to provide maximum mobility and utility. A wide range of accessories is available from your authorized Cheeta Provider to further customize your scooter to better suit your needs and/or preferences, However, under no circumstances should you modify, add, remove, or disable any feature, part, or function of your scooter.

	WARNING! Do not modify your scooter in any way not authorized by Cheeta. Unauthorized modifications may result in personal injury and/or damage to your scooter.
---	---

REMOVABLE PARTS

	WARNING! Do not attempt to lift or move a scooter by any of its removable parts, Personal injury and damage to the scooter may result.
---	---

PRE-RIDE SAFETY CHECK

Get to know the feel of your scooter and its capabilities. It is recommended that you perform a safety check before each use to make sure your scooter operates smoothly and safely, For details on how to perform these necessary inspections, see XI. "Care and Maintenance,"

Perform the following inspections prior to using your scooter:

- Check all electrical connections, Make sure they are tight and not corroded,
- Check the front-to-rear harness, Make sure it is secured properly,
- Check the brakes,
- Check battery charge,

TIRE INFLATION

II . SAFETY

If your scooter is equipped with air tires, you should check or have the air pressure checked at least once a week, Proper inflation pressures will prolong the life of your tires and help ensure the smooth operation of your scooter.

	WARNING! Do not under inflate or over inflate your tires. Low pressure may result in loss of control, and over inflated tires may burst.
	WARNING! Inflate your scooter tires {Tom a regulated air source with an available pressure gauge. Inflating your tires from an unregulated air source could over inflate them, resulting in a burst tire and/or personal injury.

WEIGHT LIMITATIONS

Your scooter is rated for a 180kg maximum weight capacity. Please refer to the specifications table for this limit.

	WARNING! Exceeding the weight limit voids your warranty and may result in personal injury and damage to your scooter. Cheeta will not be held responsible for injuries and/or property damage resulting from failure to observe weight limitations.
	WARNING! Do not carry passengers on your scooter. Carrying passengers on your scooter may result in personal injury and/or property damage.

INCLINE INFORMATION

More and more building have ramps with specified degrees of inclination designed for easy and safe access. Some ramps have turning switchbacks (180-degree turns) that require you to have good cornering skills on the scooter.

When climbing an incline, try to keep your scooter moving. If you must stop, start up again slowly, and then accelerate cautiously. When driving down an incline, do so by setting the speed adjustment dial to the slowest setting and driving in the forward direction only. If your scooter starts to move down the incline faster than you anticipated or desired, allow it to come to a complete stop by releasing the throttle control lever. Then push the throttle control lever forward slightly to ensure a safely controlled descent.

WARNING! You should not travel up or down a potentially hazardous incline(i.e., areas covered with snow, ice, cur grass, or wet leaves).

 **WARNING!** When you climbing an incline, do not drive the switchbacks and do not Forms the angle with the incline, it will reduce the possibility of the turning over.

WARNING! Do not drive the scooter in the wrong direction when climbing and/or downgrading, in order to avoid injure

The max. safety climbing angle of the scooter is 10

Please see the figure 1 and 2.

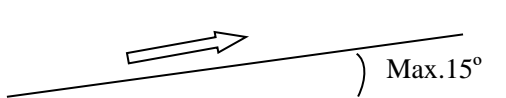

Figure1

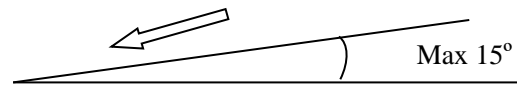

Figure2

 **WARNING!** Any climbing the incline which the angle is more than 8 will hurt yourself and break the scooter.

Handicap public access ramps are not subject to government regulation in all countries, and therefore do not necessarily share the same standard degree of slope.

II . SAFETY

Other inclines maybe natural or, if man-made, not designed specifically for scooters, Figure 1 illustrates your scooter's stability and its ability to climb grades under various weight loads and under controlled testing conditions.

These tests were conducted with the scooter's seat in the highest position and adjusted rearward on the seat base to its farthest rearward position, Use this information as a guideline, Your scooter's ability to travel up inclines is affected by your weight, your scooter's speed, your angle of approach to the incline, and your scooter setup.

CORNERING INFORMATION

Excessively high cornering speeds can create the possibility of tipping Factors which affect the possibility of tipping include, but are not limited to, cornering speed, steering angle (how sharply you are turning), uneven road surfaces, inclined road surfaces, riding from an area of low traction to an area of high traction (such as passing from a grassy area to a paved area - especially at high speed while turning), and abrupt directional changes High cornering speeds are not recommended If you feel that you may tip over in a corner, reduce your speed and steering angle (i.e., lessen the sharpness of the turn) to prevent your scooter from tipping

 **WARNING!** When cornering sharply, reduce your speed. When using your scooter at higher speeds, do not corner sharply. This greatly reduces the possibility of n tip or fall. To avoid personal injury or property damage, always exercise common sense when cornering.

OUT DOOR DRIVING SURFACES.

Our scooter is designed to provide optimum stability under normal driving conditions –dry, level surfaces composed of concrete, blacktop, or asphalt. However, there will be times when you will encounter other surface types. For this reason, your scooter is designed

to perform admirably on packed soil, grass, and gravel. Feel free to use your scooter safely on lawns and in park areas.

- Reduce your scooter's speed when driving on uneven terrain and/or soft surfaces.
- Avoid tall grass that can become tangled in the running gear.
- Avoid loosely packed gravel and sand.
- If you feel unsure about a driving surface, avoid that surface.

STREETS AND ROADWAYS



WARNING! You should not operate your scooter on public streets and roadways. Be aware that it may be difficult for traffic to see you when you are seated on your scooter. Obey all local pedestrian traffic rates. Wait until your path is clear of traffic, and then proceed with extreme caution.

INCLEMENT WEATHER PRECAUTIONS



WARNING! Cheeta recommends that you do not operate your scooter in icy or slippery conditions or on salted surfaces (i.e., walks or roads). Such using may result in an accident, personal injury, or adversely affect the performance and safety of your scooter.

WARNING! Do not operate or store your scooter where it may be exposed to inclement weather conditions such as rain, snow, mist, and below freezing temperatures (such as storage on an outside car/van lift). Attempting to operate the scooter in such conditions can damage the electronics and potentially result in loss of control.

FREEWHEEL MODE

Your scooter is equipped with a manual freewheel lever that, when pulled up, allows the scooter to be pushed. For more information about how to place your scooter into and out of freewheel mode, please to the operation picture on the scooter which signed down of the seat.



WARNING! When your scooter is in freewheel mode, the braking system is disengaged. Disengage the drive motors only on a level surface. Ensure the key is removed from the key switch. Stand behind the scooter to engage or disengage freewheel mode. Never sit on a scooter to do this. After you have finished pushing your scooter, always return it to the drive mode to lock the brakes.

II. SAFETY

STAIRS AND ESCALATORS

Scooters are not designed to travel up or down stairs or escalators. Always use an elevator.



WARNING! Do not use your scooter to negotiate steps or escalators. You may cause injury to yourself and to others and/or damage your scooter.

ELEVATORS

Modern elevators have a door edge safety mechanism that, when pushed, reopens the door(s).

- If you are in the doorway of a elevator when the door(s) begin to close, push on the rubber door edge or allow the rubber door edge to contact the scooter and the door will reopen,
- Use care that pocketbooks, packages, or scooter accessories do not become caught in elevator doors,

LIFT/ELEVATION PRODUCTS

Cheeta recommends that you review the instructions and safety information from the manufacturer of the lift..



WARNING! Never sit on your scooter when it is being used in connection with any type of lift/elevation product. Your scooter was not designed with such use in mind, and any damage or injury incurred from such use is not the responsibility of Cheeta

BATTERIES

In addition to following the warnings below, be sure to comply with all other battery handling information.



WARNING! Scooter batteries are heavy (refer to specifications table). Lifting weight beyond your capacity could result in personal injury. If necessary, get someone physically able to lift the scooter batteries for you.; Always protect the batteries from freezing and never charge a frozen battery Charging a frozen battery may result in personal injury and/or damage to the battery; RED (+) cables must be connected to positive (+) battery terminals/posts. BLACK (-) cables must be connected to negative (-) battery terminals/posts. Failure to connect your battery harnesses in the proper manner may result in personal injury and/or damage to your scooter. Replace cables immediately if damaged.

BATTERY DISPOSAL AND RECYCLING

If you encounter a damaged or cracked battery, immediately enclose it in a plastic bag and call your authorized Cheeta for instructions on disposal, Your authorized Cheeta Provider will also have the necessary information on battery recycling, which is our recommended course of action,

MOTOR SCOOTER TRANSPORT

Currently, there are no standards approved for tie-down systems in a moving scooter of any type to transport a person while seated in a scooter,



WARNING! Do not sit on your scooter while it is in a moving scooter. Personal injury and/ or property damage may result.

WARNING! Always be sure your scooter and its batteries are properly secured when it is being transported. Failure to do so may result in personal injury and/or damage to your scooter.

PREVENTING UNINTENDED MOVEMENT



WARNING! If you anticipate being seated in a stationary position for an extended period, turn off the power. This will prevent unexpected motion from inadvertent throttle control lever contact. Failure to do so may result in personal injury.

II . SAFETY

GETTING ONTO AND OFF OF YOUR POWER CHAIR

Getting onto and off of your scooter requires a good sense of balance. When you getting on and off ,it requires your personal professionals to help you.

Avoid hurting when you getting onto and off your scooter, please observe the following safely tips.

POWER DOWN YOUR SCOOTER.

- ensure that your scooter is not in freewheel mode.
- the seat armrests can be flipped up to make getting on and off f the scooter.
- reduce the distance of you and your scooter.



WARNING! Position yourself as far back as possible in the scooter seat to prevent the scooter from tipping and causing injury.

avoid using your armrests for weight bearing purposes. Such use may cause the scooter to tip and cause personal injury.

Avoiding putting all your weight on the floorboard. Such use may cause the scooter to tip and cause personal injury.

POSITIONING BELTS

Your authorized Cheeta Provider, therapist(s), and other healthcare professionals are responsible for determining your requirement for a positioning belt in order to operate your scooter safely.



WARNING! If you require a positioning belt to safely operate your scooter, make sure it is fastened securely. Serious personal injury may result if you fall from the scooter.

REACHING AND BENDING

Avoid reaching or bending while driving your scooter. If it is necessary to reach, lean, or bend while seated on your scooter, it is

important to maintain a stable center of gravity and keep the scooter from tipping. CHEETA recommends that the scooter user determine his/her personal limitations and practice bending and reaching in the presence of a qualified healthcare professional.



WARNING! Do not bend, lean, or reach for objects if you must pick them up from the floor by reaching down between your knees. Movements such as these may change your center of gravity and the weight distribution of the scooter. This may cause your NINJA to tip, possibly resulting in personal injury

REMOVABLE PARTS

Do not push any parts of the scooter, it will hurt the power chair and injury yourself.

PRESCRIPTION DRUGS/PHYSICAL LIMITATIONS

The scooter user must exercise care and common sense when operating his/her scooter. This includes awareness of safety issues when taking prescribed or over-the-counter drugs or when the user has specific physical limitations,



WARNING! Consult your physician if you are taking prescribed or over-the-counter medication or if you have certain physical limitations. Some medications and limitations may impair your ability to operate your scooter in a safe manner.

ALCOHOL

The scooter user must exercise care and common sense when operating his/her scooter. This includes awareness of safety issues while under the influence of alcohol.



WARNING! Do not operate your scooter while you are under the influence of alcohol, as this may impair your ability to drive safely.

III. EMI/RFI

EMI/RFI WARNINGS

Laboratory tests performed by the Food and Drug Administration (FDA) have shown that radio waves can cause unintended motion of electric mobility scooters. Radio waves are a form of electromagnetic energy (EM). When electromagnetic energy adversely affects the operation of an electrical device, that adverse effect is called Electromagnetic Interference (EMI) or Radio Frequency interference (RFI).

EMI/RFI FREQUENTLY ASKED QUESTIONS (FAQS)

The following FAQs summarize what you should know about EMI/RFI. Use this information to minimize the risk that EMI/RFI will adversely affect your mobility scooter.

WHERE DO RADIO WAVES COME FROM?

Radio waves are emitted from the antennas of cellular phones, mobile two-way radios (such as walkie-talkies and CBs), radio stations, TV stations, amateur radio (HAM) transmitters, wireless computer links, microwave sources, and paging transmitters. Radio waves are a form of electromagnetic energy (EM). EM is more intense closer to transmitting antennas, which are sources of emission. The greater the transmission strength, the greater the concern to electric mobility scooter users.

IF EMI/RFI AFFECTS MY MOBILITY SCOOTER, WHAT KIND OF MOTION SHOULD I EXPECT?

This is difficult to predict. The answer would depend on several factors:

- The strength of the radio waves.
- The construction of your NINJA mobility scooter.
- The location of your mobility scooter (whether it is on the level ground or on an incline).
- Whether or not your mobility scooter is in motion.

The motion of any electric mobility scooter affected by EMI/RFI can be erratic. The mobility scooter may come to a sudden stop or move in an uncontrolled manner. Also, it is possible for EMI/RFI to release the brakes of an electric mobility scooter. Some intense EMI/RFI can even damage the control system components of an electric mobility scooter.

IS THERE ANY WAY TO KNOW FOR CERTAIN WHETHER OR NOT RADIO WAVES ARE THE CAUSE OF ANY UNINTENDED MOBILITY SCOOTER MOTION?

Unfortunately, EMI/RFI may be difficult to recognize, because the signals from radio sources are invisible and may be intermittent. However, the FDA recommends that you report all incidents of unintended motion or unintended brake release of your mobility scooter to its manufacturer and, if possible, determine whether there was a radio wave source nearby at the time of the incident.

One precaution you can take against unintended motion of your mobility scooter is to make certain that you or someone else is not the cause of the unintended motion.

- Turn off your mobility scooter by removing the key from the key switch when you are getting on or off of your mobility scooter.
- Never leave the key in the key switch of an unattended mobility scooter,
- By following these steps, you greatly reduce the risk of you or anyone else inadvertently bumping the throttle control levers and causing the mobility scooter to move unintentionally

HAS ANYONE BEEN INJURED BY THE ERRATIC, UNINTENDED MOTION OF AN ELECTRIC MOBILITY SCOOTER?

The FDA has reports of injuries that resulted from uncontrolled motion of electric mobility scooters, but it is not clear just how many of those injuries were caused by EMI/RFI.

ARE ALL ELECTRIC MOBILITY SCOOTERS SUSCEPTIBLE TO EMI/RFI?

Each make and model of electric mobility scooter differs in its ability to resist EM/RFI. Every mobility scooter has a particular level of resistance to EMI/RFI. This resistance is measured in volts per meter (V/m). A higher resistance level offers greater protection

III. EMI/RFI

against EMI/RFI. In other words, an electric mobility scooter with a high resistance level is less likely to be affected by a strong radio source than is an electric mobility scooter with a low resistance level,

WHAT IS THE FDA DOING ABOUT THE PROBLEM?

The FDA has written to electric mobility scooter manufacturers and requested that those manufacturers test their new mobility scooter models to be certain that they provide a reasonable degree of resistance against EMI/RFI. The FDA has stated that all newly manufactured electric mobility scooter models should have a resistance level of at least 20 V/m, This level of resistance provides a reasonable degree of protection against the common sources of EMI/RFI.

The FDA has also requested or recommended that:

- Electric mobility scooter manufacturers clearly label new products with their resistance level or state that the resistance level is not known,
- The labeling or informational material supplied with new electric mobility scooters must explain what the resistance level means and warn users about the possibility of EMI/RFI and how to avoid it.
- Electric mobility scooter manufacturers undertake an educational program to inform electric mobility scooter users and their caregivers about the problems associated with EMI/RFI and about the actions they can take to minimize the risk of EMI/RFI.
- While there is no exact way to tell if your mobility scooter is totally safe, an immunity level of 20 V/m is generally achievable and useful, This product has been tested and passed at an immunity level of 20 V/m.

WHAT CAN I DO TO FIND OUT IF MY MOBILITY SCOOTER IS LIKELY TO BE AFFECTED BY EMI/RFI?

If you have had your mobility scooter for some time and have not experienced any unintended motion, it is not likely that you will have a problem in the future, However, it is always possible that EMI/RFI problems could arise If you are close to a source of radio waves, Therefore, it is very important for you to be alert to this possibility, The mobility scooter meets or exceeds a resistance level of at least 20 V/m.

WHAT CAN I DO TO REDUCE THE RISK OF MY MOBILITY SCOOTER BEING AFFECTED BY EMI/RFI?

Here are some precautions you can take:

- Do not turn on or use hand-held personal communications devices, such as citizens band (CB) radios and cellular phones, while your mobility scooter is turned on.
- Be aware of nearby radio wave transmitters, such as radio or TV stations and hand-held or mobile two-way radios, Try not to operate your mobility scooter too close to those transmitters, For example, if you are on an electric mobility scooter with a resistance level of at least 20 V/m, you should remain at least three feet from a hand-held two-way radio and at least ten feet from a mobile two-way radio,
- Be aware that adding accessories and/or components, or modifying your mobility scooter in any way, may change its EMI/RFI resistance level and may make it more susceptible to interference from radio wave sources,

WHAT SHOULD I DO IF MY MOBILITY SCOOTER MOVES UNEXPECTEDLY?

If unintended motion or unintended brake release occurs, turn off your mobility scooter (by removing the key) as soon as it is safe to do so.

IV. NINJA CANOPY



Figure 3.

With improved technology and products, it possibly have some difference between the actual parameters and which provided in the above table. But it won't affect your normal using. If you have some questions about it, please contact us with the following way.

Overall dimension	77*31*77"	Front tire / Rear tire	8" x 6" air tire
Weight capacity	500#	Controller	120A
Motor	48V/1100W	Lithium Battery	48V/30AH
Charger	48V/ 5A	Recharge time	2-4 hrs
Incline capability	35 degrees	Turning radius (min)	70"
Range	up to 28 mi per battery charge	Ground Clearance	5"
Max. forward speed	18 mph	Net weight (with batteries)	205#

IV. YOUR SCOOTER

POWER SWITCH AND SPEED REGULATION

They are under the seats

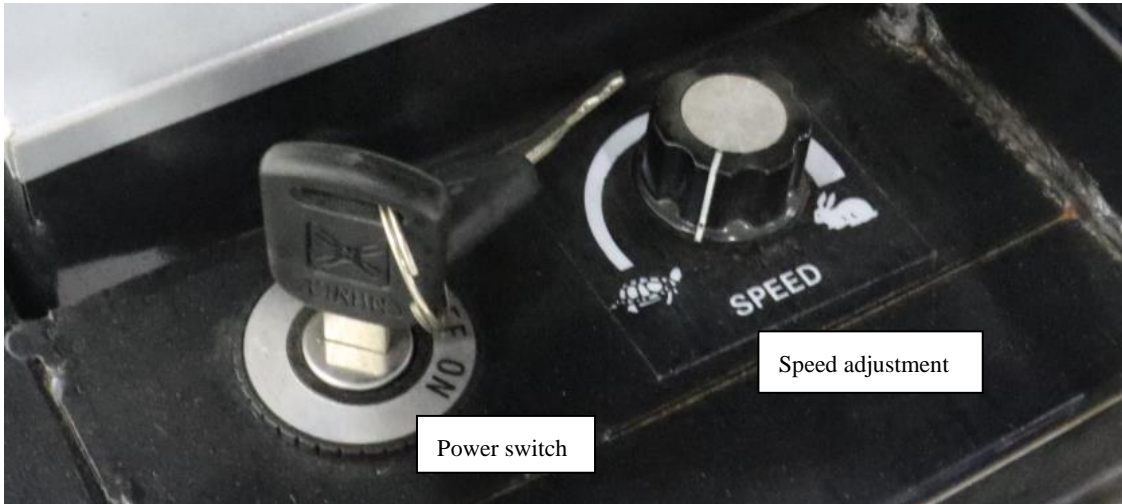

CONTROL CONSOLE ASSEMBLY

The control console assembly located on the front section houses all of the controls you need to operate your scooter, See the following figure 4.



Figure 4.

- (1) Dashboard
- (2) Forward/backward button
- (3) Cup holder
- (4) Headlight switch: Move up to turn on the headlights, and slide down to turn off the headlights.
- (5) Mobile phone holder

DASHBOARD



IV. YOUR SCOOTER

FORWARD/BACKWARD BUTTON



Usually Cheeta set this switch to choose the forward and reverse.
Press to the left to move forward, and press to the right to reverse.

MANUAL FREEWHEEL LEVER

Whenever you want to push your scooter for short distances, you can put it in freewheel mode

- The manual freewheel lever is located on the end of the motor/transaxle assembly at the right rear of the scooter,
- Pull up on the manual freewheel lever to disable the drive system and the brake system, please see the right figure(pull up to the A direction)
- you will then be able to push your scooter,
- Push down on the manual freewheel lever(the B direction) to reengage the drive system and the brake system and take your scooter out of freewheel mode.



Figure 4.



WARNING! When your scooter is in freewheel mode, the braking system is disengaged. Disengage the drive motors only on a level surface. Ensure the key is removed from the key switch.

Stand behind the scooter to engage or disengage freewheel mode. Never sit on a scooter to do this.

After you have finished pushing your scooter, always return it to the drive mode to lock the brakes.

ANTI-TIP WHEELS

The anti-tip wheels are an integral and important safety feature designed to help prevent your scooter from tipping rearwards on an incline. They are bolted to the frame at the rearmost part of your scooter



WARNING! Do not remove the anti-tip wheels or modify your scooter in any way that is not authorized by Cheeta.

V. BATTERIES AND CHARGING

BATTERIES AND CHARGING



WARNING! Ensure that the first charging need more than 12 hours and before the first charging, the batteries should be used empty

1. Charge your scooter's batteries prior to using it for the first time.
2. Keep the batteries fully charged to keep your scooter running smoothly
3. Use only the onboard battery charger supplied with your scooter.

READING YOUR BATTERY VOLTAGE

The battery condition meter on the control console assembly indicates the approximate strength of your batteries using a color code. Green indicates fully charged batteries~ yellow a draining charge, and red indicates that an immediate recharge is necessary. To ensure the highest accuracy, the battery condition meter should be checked while operating your scooter at full speed on a dry, level surface.

You can also check the charge by the ammeter, located at the rear of the scooter near the charger power cord receptacle. The charger power cord must be plugged into a standard wall outlet in order to obtain a reading.

CHARGING YOUR BATTERIES

Follow these easy steps to charge your batteries safely:

1. Position your scooter close to a standard wall outlet.
2. Remove the key from the key switch.
3. Make certain that the manual freewheel lever is in the drive (down) position.
4. Plug the charger power cord into the charger power cord receptacle on your scooter.
5. Extend the charger power cord and plug it into the wall outlet. It is recommended that you charge your batteries for 8 to 14 hours.
6. When the batteries are fully charged, unplug the charger power cord from the wall outlet and then from the charger power cord receptacle,



Figure 5.



WARNING! Never use an extension cord to plug in your buttery charger. Plug the charger directly into a properly wired standard wall outlet.

BATTERY REPLACEMENT

To change a battery in your scooter:



WARNING! Battery posts, terminals, and related accessories contain lead and lead compounds. Wash hands after handling.

1. Power down your scooter and remove the key.
2. Remove the seat,
3. Gently life the rear shroud off of your scooter high enough to be able to disconnect the rear lighting harnesses
4. Disconnect the battery tie-down strap,
5. Disconnect the battery harness from the battery harness mating plug, See figure 12A.
6. Disconnect the battery cables from the battery terminals,
7. Remove the old battery,
8. Place a new battery in the battery well,
9. Connect the red battery cable to the positive (+) battery terminal,

V. BATTERIES AND CHARGING

10. Connect the black battery cable to the negative (-) battery terminal,
11. Reconnect the battery harness to the battery harness mating plug,.
12. Reconnect the battery tie-down strap,
13. Reconnect the rear lighting harnesses,
14. Reinstall the rear shroud and the seat,

BATTERY DISPOSAL AND RECYCLING

If you encounter a damaged or cracked battery, immediately enclose it in a plastic bag and call your authorized Cheeta Provider for instructions on disposal. Your authorized Cheeta Provider will also have the necessary information on battery recycling, which is our recommended course of action.

FREQUENTLY ASKED QUESTIONS (FAQs)

How does the charger work?

When battery voltage is low, the charger works harder and sends more electrical current to the batteries to bring up their charge. As battery voltage approaches a full charge, the charger sends less electrical current to the batteries. When the batteries are fully charged, the current sent from the charger is at nearly zero amperage. Therefore, when the charger is plugged in, it maintains the charge on your batteries but does not overcharge them. We do not recommend that you charge your batteries for more than 24 consecutive hours.

CAN I USE A DIFFERENT CHARGER?

For the safest, most efficient, and balanced charging of the batteries, you should only use the Cheeta battery charger.

HOW OFTEN MUST I CHARGE THE BATTERIES?

Two major factors must be considered when deciding how often to charge the batteries:

1. All day scooter use on a daily basis.
2. Infrequent or sporadic scooter use.

With these considerations in mind, you can determine just how often and for how long you should charge the batteries. The onboard battery charger is designed so that it does not overcharge your scooter's batteries; however, you may encounter some problems if you do not charge your batteries often enough and if you do not charge them on a regular basis. Following the five guidelines below provides safe and reliable battery operation and charging.

- If you use your scooter daily, charge its batteries as soon as you finish using it for the day. Your scooter will be ready each morning to give you a "full day" of service. We recommend you charge the batteries for 8 to 14 hours after daily use.
- If you use your scooter once a week or less, charge its batteries at least once a week for 12 to 14 hours at a time.
- Keep the batteries fully charged.
- Avoid deeply discharging the batteries.
- Do not charge the batteries for more than 24 consecutive hours.

WHY DO MY NEW BATTERIES SEEM WEAK?

Deep-cycle batteries employ a different chemical technology than that used in car batteries, nickel-cadmium batteries (nicads), or in other common battery types. Deep-cycle batteries are specifically designed to provide power, drain down their charge, and then accept a relatively quick recharge.

We work closely with our battery manufacturer to provide batteries that best suit your scooter's specific electrical demands. Fresh batteries arrive daily at Pride and are shipped fully charged to our customers. During shipping, the batteries may encounter temperature extremes that can influence their initial performance. Heat diminishes the charge on the battery; cold slows the available power and extends the time needed to recharge the battery.

It may take a few days for the temperature of the batteries to stabilize and adjust to their new room or ambient temperature,

V. BATTERIES AND CHARGING

More importantly, it takes a few charging cycles--partial draining followed by full recharging--to establish the critical chemical balance

that is essential to a deep-cycle battery's peak performance and long life.

Please follow these steps to properly break-in your new batteries for maximum efficiency and service life.

1. Fully charge any new battery prior to its initial use. This initial charging cycle brings the batteries up to about 88% of their peak performance level,
2. Operate your scooter in familiar and safe areas, Drive slowly at first, and do not travel too far from your home or familiar surroundings until you have become accustomed to the controls and have properly broken in the batteries,
3. Fully recharge the batteries, This recharge should bring the batteries up to about 90% of their peak performance level,
4. Operate your scooter again,
5. Fully recharge the batteries again,
6. After four or five charging cycles, the batteries are able to receive a charge of 100% of their peak performance level and are able to last for an extended period of time,

HOW CAN I ENSURE MAXIMUM BATTERY LIFE?

Fully charged deep-cycle batteries provide reliable performance and extended battery service life, Keep the batteries fully charged whenever possible, Batteries that are deeply discharged, infrequently charged, or stored without a full charge may be permanently damaged and cause unreliable performance and limited service life,

WHAT ABOUT PUBLIC TRANSPORTATION?

If you intend to use public transportation with your scooter, you must contact the transportation Provider in advance to determine their specific requirements,

How should I store my scooter and its batteries?

See IX.Care and Maintenance,"

BEFORE GETTING ONTO YOUR SCOOTER

- Have you fully charged the batteries? See VI. "Batteries and Charging."
- Is the manual freewheel lever in the drive (down) position? Never leave the manual freewheel lever pulled up unless you are manually pushing your scooter.

VI. INSTALLATION GUIDANCE

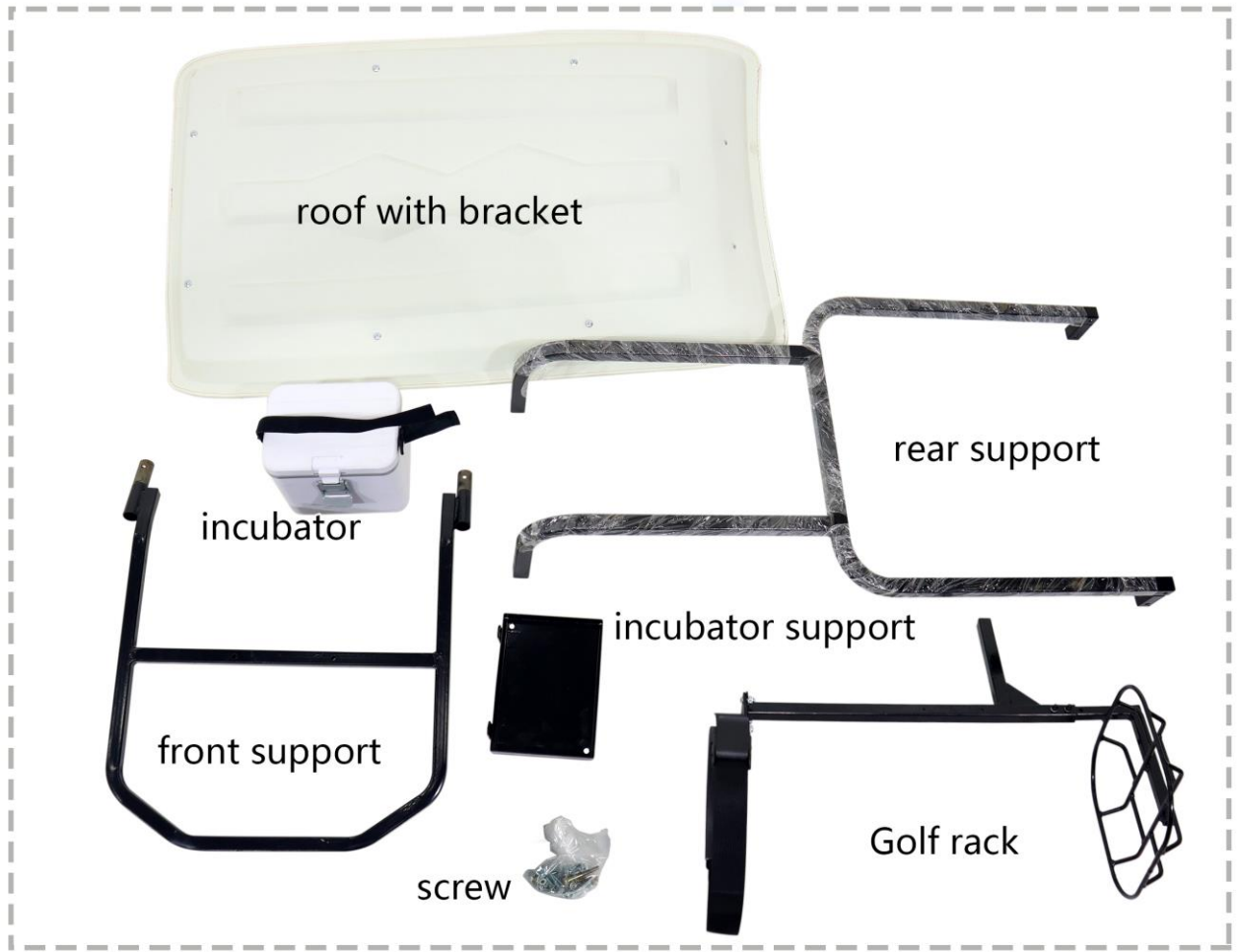

VI. INSTALLATION GUIDANCE

Fastening Classification Diagram

M8*40 cylinder hexagon screw
M8 cap nut
M8 flat pad
*2 sets



install the faucet handle

M10*40 cylinder hexagon screw
*2 sets



install under the front support

M10*40 cylinder hexagon screw*2
M10*80 cylinder hexagon screw*2
M10 self locking nut*4
M10 flat pad*4



install under the rear support

M6*40 half round hexagon screw
M6 cap nut
M6 flat pad
*2 sets



install the glass

M8*65 cylinder hexagon screw
M8 cap nut
M8 flat pad
*2 sets



install the front roof bracket

M6*40 half round hexagon screw
M6 cap nut
M6 flat pad
*2 sets



install the rear roof bracket

M8*40 cylinder hexagon screw
M8 cap nut
M8 flat pad
*2 sets



install the Golf rack

M6*40 countersunk head hexagon socket screw
M6 cap nut
M6 flat pad
*2 sets



install the incubator support

TRIPS:

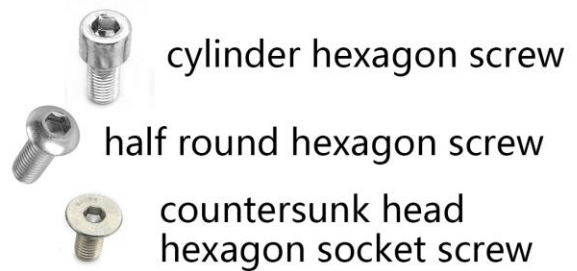
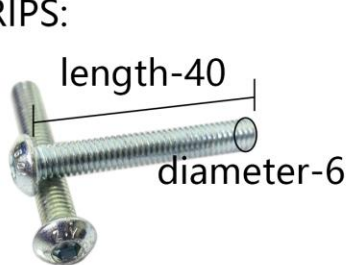

VI. INSTALLATION GUIDANCE



Insert the faucet tube.



↑ Grasp the faucet handle and move out of the scooter slowly.

VI. INSTALLATION GUIDANCE

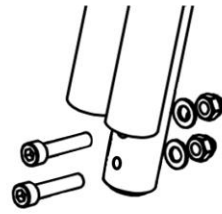

➔ Install the screw of the faucet handle.

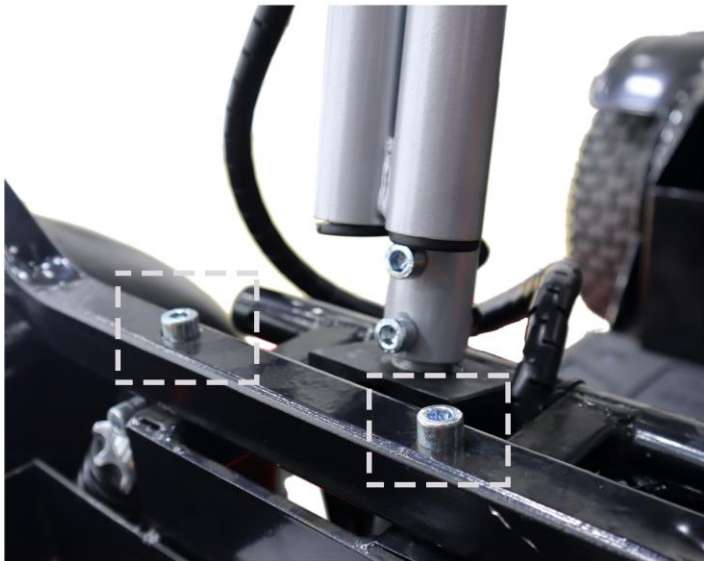

➔ Install front support. Tighten the screws.



➔ Pull the push rod under the seat to fix the seat.



VI. INSTALLATION GUIDANCE

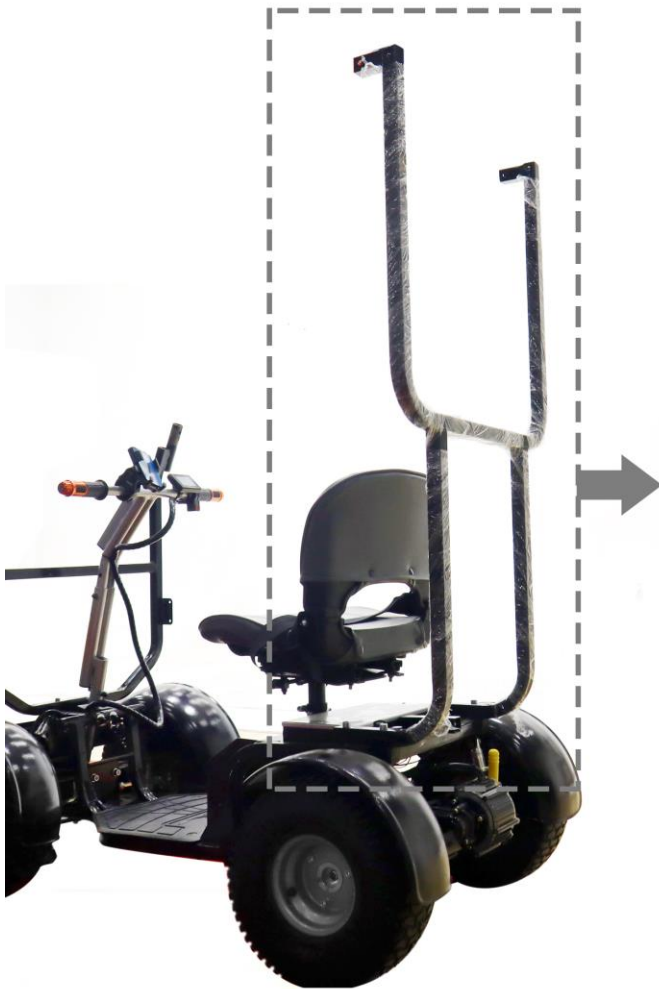

➔ Install rear bracket

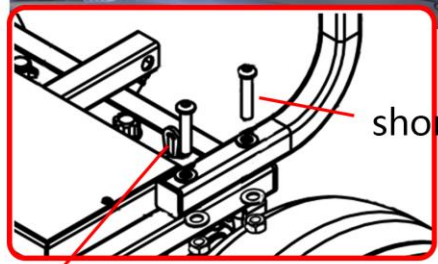

short screw

long screw



➔ Install glass.
Tighten the screws.

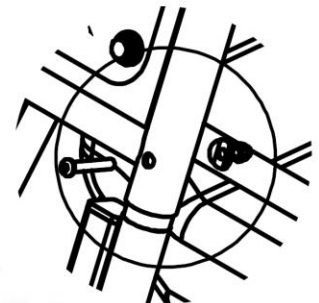

VI. INSTALLATION GUIDANCE

- ➔ Pay attention to the front and rear of the roof.
Install two parts as shown in the figure.
Tighten the screws.

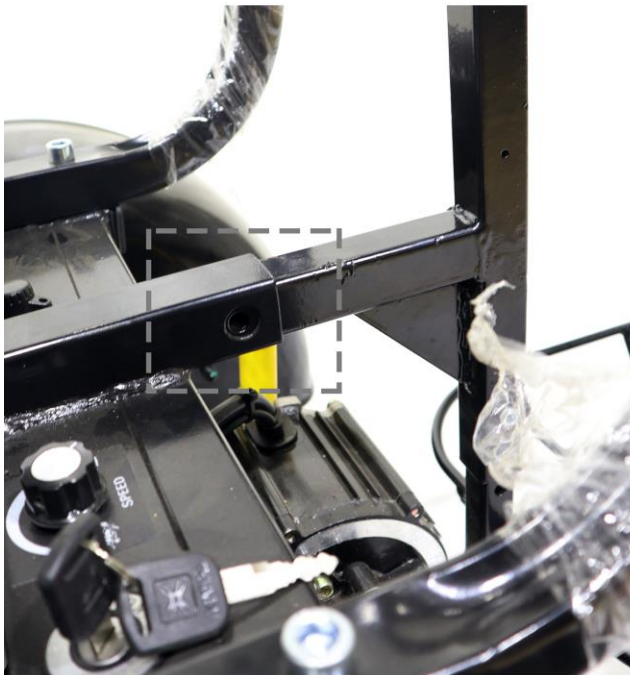

- ➔ Install the Golf Stand.



VI. INSTALLATION GUIDANCE

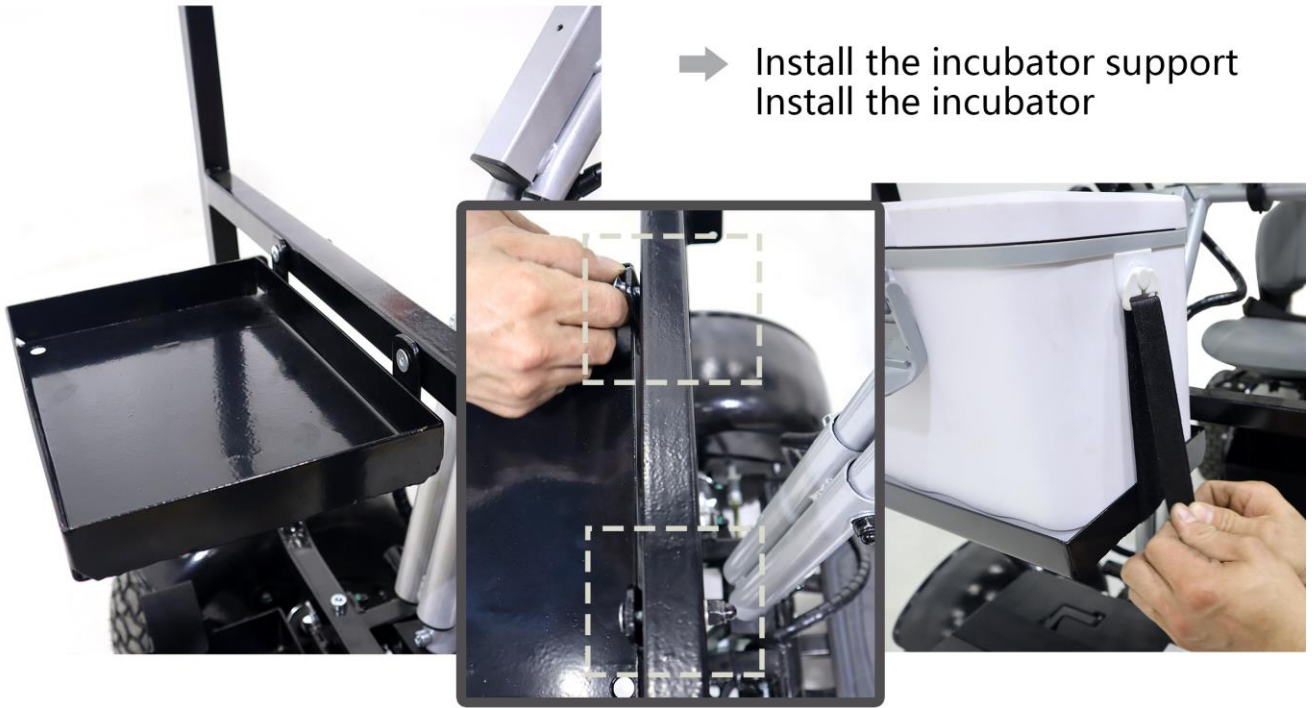

- ➔ Put the battery into the battery compartment.
- ➔ Fixed battery.
- ➔ Connect the battery cable.



VII. COMFORT ADJUSTMENTS

GETTING ONTO YOUR SCOOTER



WARNING! Never attempt to board or exit your scooter without first removing the key from the key switch. This will prevent the scooter from moving if accidental throttle control lever contact is made

1. Make certain that the key is removed from the key switch.
2. Stand at the side of your scooter.
3. Push forward on the seat lock lever and rotate the seat until it is facing you.
4. Make certain that the seat is locked securely in position.
5. Position yourself comfortably and securely in the seat,
6. Push forward on the seat lock lever and rotate the seat until you are facing forward.
7. Make certain that the seat is locked securely in position.
8. Make certain that your feet are safely on the floorboard.

PRE-RIDE ADJUSTMENTS AND CHECKS

Are you positioned comfortably in the seat?

- Is the seat at the proper height?
- Is the seat locked securely in place?
- Is the tiller at a comfortable setting and locked securely in place?
- Is the key fully inserted into the key switch and turned clockwise to the "on" position?
- Does the scooter's horn work properly?
- Is your proposed path clear of people, pets, and obstacles?
- Have you planned your route to avoid adverse terrain and as many inclines as possible?

OPERATING YOUR SCOOTER

Always keep both hands on the tiller and your feet on the floorboard while operating your scooter. This driving position gives you the most control over your scooter.

- Set the speed adjustment dial to your desired speed.
- Press your thumb against the appropriate throttle control lever.
- Pull on the left handgrip to steer your scooter to the left. Pull on the right handgrip to steer your scooter to the right.
- Move the tiller to the center position to drive straight ahead.
- To stop, slowly release the throttle control lever. The electronic brakes will automatically engage when your scooter comes to a stop.



NOTE: Your scooter ~ reverse speed is slower than that of the ,forward speed you preset with the speed adjustment dial.

GETTING OFF OF YOUR SCOOTER

1. Bring your scooter to a complete stop
2. Remove the key from the key switch.
3. Push forward on the seat lock lever and rotate the seat until you are facing toward the side of your scooter
4. Make certain that the seat is locked securely in position
5. Carefully and safely get out of the seat and stand to the side of your scooter
6. You can leave the seat facing to the side to facilitate boarding your scooter next time

POWER DOWN TIMER FEATURE

Your scooter is equipped with an energy saving automatic power down timer feature designed to preserve your scooter's battery life. If you mistakenly leave the key in the key switch and in the '-on' position but do not use your scooter for approximately 20 minutes, the scooter's controller shuts down automatically. Although the controller is shut down, power will still be supplied to the scooter's lighting system. If the power down timer feature takes effect, perform the following steps to resume normal operation

- Turn the key to the "off" position
- Turn the key back to the "on" position

VII. COMFORT ADJUSTMENTS



WARNING! Remove the key from the key switch before adjusting the tiller or the seat. Never attempt to adjust the tiller or the seat while the scooter is in motion.

SEAT HEIGHT ADJUSTMENT

To reposition the seat to one of different heights:

1. Remove the seat from your scooter. Push and hold the seat lock lever forward to unlock the seat, then rotate the seat and lift it off of the scooter,
2. Remove the rear shroud,
3. Raise or lower the upper seat post to the desired seat height,
4. Line up another locating hole in the upper seat post with the hole in the lower seat post,
5. Reinstall the hardware and tighten.
6. Replace the rear shroud and the seat.



Figure 6.

SEAT TURNING ADJUSTMENT

This adjustment can help the user much more easily to get on the scooter. Please see the following figure.

Pull up the plastic hand(A), and turn to the B/C direction. Then to sit onto the seat, and turn back the first direction, release you hand to make sure that the pin into the hole (you cannot turn any direction without the plastic hand up), it is very important to your health. Otherwise, you will be injured.



Figure 7.



WARNING! Always keep your back pressed firmly against the seatback while adjusting the angle.
WARNING! Do not operate your scooter with the seatback in a reclined position.

VIII. BASIC TROUBLESHOOTING

Any electromechanical device requires occasional troubleshooting. However, most problems that arise can usually be solved with a bit of thought and common sense. Many of these problems occur because the batteries are not fully charged or because the batteries are worn down and can no longer hold a charge.

WHAT IF ALL OF MY SCOOTER SYSTEMS APPEAR TO BE "DEAD."

1. make certain that the key is fully inserted in the key switch.
2. Ensure that the batteries are fully charged.
3. make certain that both battery harnesses are firmly connected.
4. make certain that the battery cables are securely connected to the battery terminals.
5. make sure that the front-to-rear harness is firmly connected.
6. remove and reinsert the key.

WHAT IF THE SCOOTER DOES NOT MOVE?

1. Your scooter was probably left in freewheel mode. When the manual freewheel lever is pulled up, the brakes are disengaged and all power to the transaxle is cut.
2. Push down the manual freewheel lever to restore normal operation to your scooter.

WHAT IF THE MAIN CIRCUIT BREAKER REPEATEDLY TRIPS?

- Charge the scooter's batteries more frequently.
- If the problem continues, have both of your scooter's batteries load tested by your authorized Cheeta Provider.
- Or, load test the batteries yourself. Load testers are available at most automotive parts stores. Follow the directions supplied with the load tester.

WHAT IF THE BATTERY CONDITION METER DIPS WAY DOWN AND THE MOTOR SURGES OR HESITATES WHEN I PRESS THE THROTTLE CONTROL LEVER?

- Fully charge your scooter's batteries.
- Have your authorized Cheeta Provider load test each battery.

If you experience any problems with your scooter that you are not able to handle, immediately contact your authorized Cheeta Provider for information, maintenance, and service.

IX. CARE AND MAINTENANCE

The scooter is a sophisticated victory. Like any motorized scooter, it require maintenance checks. You can check it yourself, but others require assistance from the dealer of CHEETA. Preventive maintenance is very important. If you follow the maintenance checks in this section as scheduled, you can help ensure that your scooter gives you years of trouble-free operation. If you have any doubt as to your scooter's care or operation, contact the dealer of the CHEETA.



WARNING! Your scooter like most electrical equipment is susceptible to damage from the elements. Avoid damp areas of any kind. Water can cause electrical components to corrode and the chair's frame to rust.

SHOULD YOUR SCOOTER COME IN CONTACT WITH WATER?

1. Dry your scooter as thoroughly as possible with a towel.
2. Allow your scooter to sit in a warm, dry place for 12 hours to allow unseen water to evaporate.
3. Check the joystick operation and the brakes before using your scooter again.
4. If any inconsistencies are found, take your chair to your authorized CHEETA Provider.

GENERAL GUIDELINES

- Avoid knocking or bumping the controller
- Avoid prolonged exposure of your scooter to extreme conditions, such as heat, cold, or moisture.
- Keep the controller clean.
- Check all connectors to ensure that they are all tight and secured properly.
- All wheel bearings are pre lubricated and sealed. They require no subsequent lubrication.

CHECKING.

1、 Daily checks

- Check the rubber boot around the base of the joystick for damage. Visually inspect the boot. Do not handle or try to repair it. See your authorized CHEETA if there is a problem.
- Visually inspect the controller cable. Make sure that it is not frayed, cut or has any wires exposed. See your authorized CHEETA if there is a problem.

2、 Weekly checks

- Disconnect and inspect the controller battery door. Look for corrosion. Contact your authorized CHEETA if necessary.
- Check the brakes. This test should be carried out on a level surface with at least three feet of clearance around your power chair.

3、 monthly checks

- Check that the anti-tip wheels do not rub the ground when you operate the power chair. Adjust them as necessary.
- Check for drive tire wear. See your authorized CHEETA for repair.
- Check for extreme wear on the anti-tip wheels. Replace them as necessary.
- Check the caster forks for damages or fluttering which indicates that they may need to be adjusted or have the bearing replaced. See your authorized CHEETA for repair
- Keep your scooter clean and free of foreign material, such as mud, dirt, hair, food drink, etc. Take your power chair to your authorized CHEETA for yearly maintenance. This helps ensure that your power chair is functioning and helps prevent the future complications.



NOTE: Please deal with the former battery as the local way of dealing with the castoff.

CORRECTIVE MAINTENANCE

If the battery condition meter does not light up when you turn on the power.

- Check the harness connections. Make sure they are tight.
- Check the circuit breaker. Reset it if necessary.
- Check the battery connections.

If the above conditions prove normal, you can load test the batteries with a battery tester. These testers are available at automotive

IX. CARE AND MAINTENANCE

parts stores. Disconnect both batteries before load testing and follow the directions that come with the load tester. If either one of the batteries fails the load test, replace both of them. If your scooter still does not power up, contact your authorized CHEETA Provider.

OTHER CORRELATION COMPLEXION

1、Temperature

Some of the parts of your scooter are easy to extreme changes in temperature. Always keep your scooter between the temperatures of 18 degree to 70 degree.

- In extremely cold temperature the batteries may freeze. The specific temperature at which they freeze depends on a number of factors, such as battery charge, usage, and composition of the batteries.
- The high temperature may cause your scooter to operate at a reduced speed. This reduce speed is a safety feature built into the controller that helps prevent damage to the motor and other electrical components.

2、Storage

Your scooter should be stored in a dry place, free from temperature extremes. When storing, disconnect batteries from the power.

3、Cleaning Instructions

- Never hose off your scooter or place it in direct contact with water.
- Never use any chemicals to clean a vinyl seat, as they may cause the seat to become slippery or dry out. Use water and dry the seat thoroughly.

4、When to see your authorized CHEETA Provider for service.

The following symptoms could indicate a serious problem with your power chair. If necessary, contact your authorized CHEETA Provider. When calling, have the model number, serial number, nature of the problem, and the error code if available.

◆ Motor noise	◆ pulling to one side
◆ Frayed harnesses	◆ bent or broken wheel assemblies.
◆ cracked or broken connections	◆ Jerky motion
◆ uneven wear on any of the tires	◆ powers up, but does not move

EXTERIOR SURFACES

Bumpers, tires, and trim can benefit from an occasional application of rubber or vinyl conditioner,



WARNING! Do not use a rubber or vinyl conditioner on the scooter's vinyl seat, floorboard, or tire tread. They will become dangerously slippery and result in personal injury and/or damage to your scooter.

BATTERY TERMINAL CONNECTIONS

- Make certain that the terminal connections remain tight
- The batteries must sit flat in the battery wells,
- The battery terminals should face the rear of the scooter,

WIRING HARNESES

- Regularly check all wiring connections,
- Regularly check all wiring insulation, including the charger power cord, for wear or damage,
- Have your authorized Pride Provider repair or replace any damaged connector, connection, or insulation that you find before using your scooter again,

ABS PLASTIC SHROUDS

The front tiller shroud, front shroud, and the rear shroud are formed from durable ABS plastic and are coated with an advanced formula urethane paint, A light application of car wax will help the shrouds retain their high gloss,

MOTOR BRUSHES

The motor brushes are housed inside of the motor transaxle/assembly. They should be inspected periodically for wear by your authorized Pride Provider,

X. WARRANTY

ONE-YEAR LIMITED WARRANTY

One years on all structural frame components.

ONE-YEAR LIMITED WARRANTY

For one (1) year from the date of purchase, Cheeta will replace at our option to original purchaser, free of charge, any part or electronic component found upon examination by an authorized representative of Cheeta to be defective in material and/or workmanship,

The battery is warranted by the battery manufacturer, The battery is not warranted by Cheeta, Warranty service can be performed by Cheeta or by an authorized Cheeta Provider, Do not return faulty parts to Cheeta without prior consent, All transportation costs and shipping damage incurred while submitting parts for repair or replacement are the responsibility of the original purchaser,

ONE-YEAR WARRANTY EXCEPTIONS

TRANSAXLE: In cases where there is an increase in the operational noise level, the warranty does not apply, (The increase in operational noise level usually occurs due to abusive and excessive strain on the scooter,)

MOTOR BRAKE: one-year warranty for the electrical function of the motor brake, Brake pads are not covered,

WARRANTY EXCLUSIONS

- ◆ ABS plastic shrouds and footrest covers (wear items and not warranted)
- ◆ Batteries (the battery manufacturer provides a limited warranty)
- ◆ Tires and tire tubes (wear items and not warranted)
- ◆ Upholstery and seating (wear items and not warranted)
- ◆ Repairs and/or modifications made to any part of the scooter without specific and prior consent from Cheeta
- ◆ Circumstances beyond the control of Cheeta
- ◆ Damage caused by: battery fluid spillage or leakage, abuse, misuse, accident, or negligence, improper operation, maintenance, or storage, commercial use or use other than normal
- ◆ Labor, service calls, shipping, and other charges incurred for repair of the product

THERE IS NO OTHER EXPRESS WARRANTY

Implied warranties, including those of merchantability and fitness for a particular purpose, are limited to one (1) year from the date of original purchase and to the extent permitted by law. Any and all implied warranties are excluded, this is the exclusive remedy, Liabilities for consequential damages under any and all warranties are excluded,

Some states do not allow limitations on how long an implied warranty lasts or do not allow the exclusion of limitation of incidental or consequential damages, So, the above limitation or exclusion may not apply to you.