

Golden
Patriot™



Owner's Manual
Model GR575



Thank you for purchasing your Patriot™ Scooter. We are honored you have chosen Golden Technologies for your mobility needs.

Patriot™ Model GR575

Standard Packing List:

- 1 Owner's Manual
- 1 Front Basket
- 1 Mirror (Clamp on style)
- 1 Seat with Armrests
- 2 Keys
- 1 Battery Charger
- 2 75AH Batteries
- Seat Post Nut and Bolt



DISCLAIMER

We ask that you read this manual completely before operating your new Patriot™. Golden Technologies, Inc. is not and cannot be held responsible for any damage or injury incurred due to improper or unsafe use of the Golden Patriot scooter. Golden Technologies, Inc. specifically disclaims responsibility for any bodily injury or property damage that may occur during any use that does not comply with applicable federal, state, or local laws or ordinances.

CONTENTS

I. INTRODUCTION	4-6
Features and Benefits	5
Accessories for the Patriot™ Scooter	6
II. SAFETY	7-11
III. EMI/RFI	12
IV. YOUR GOLDEN Patriot	13
Specifications	14-15
V. OPERATION	16
Control Panel	16-17
Control Options	17
Seating	18-19
Freewheel Mode	20
VI. RIDING YOUR Patriot Scooter	21
Mounting	21
Basic Driving	22
Steering in Tight Spots	23-24
VII. DISASSEMBLY	25-26
VIII. ASSEMBLY	27-28
IX. TRANSPORTING YOUR Patriot	29
X. CARE AND MAINTENANCE	30
Routine Maintenance	30
Cleaning Your Patriot Scooter	30
Batteries and Charging	31
If Your Patriot Does Not Operate	32
Diagnostics	33-34
XI. WARRANTY	35-36
Warranty/Registration Card	37

I. INTRODUCTION

Congratulations on the purchase of your new Patriot™ scooter. The Patriot combines cutting edge technology with attractive designs that are also highly functional in today's world. We at Golden Technologies, Inc. know that you have chosen a scooter that will give you years of dependable operation and also will enhance the quality of your life by providing you with the mobility to experience an active daily lifestyle.

Even though your new Patriot is both user-friendly and designed for maximum maneuverability in even the tightest spaces, we ask that you please read, understand and follow all of the instructions and suggestions in this manual before you operate your Patriot for the first time. The safe use of your new scooter is very important to us.

If you feel that you do not understand the instructions and suggestions presented in this owner's manual, or if, for any reason, you do not feel capable of performing the activities necessary to assemble, disassemble, operate, or maintain your Patriot, please contact your local Golden Technologies, Inc. dealer or call Golden Technologies, Inc. Technical Support Services at (800) 624-6374.

Golden Technologies, Inc. cannot be held responsible for personal injury or property damage resulting from the unsafe or the improper use of any of our broad range of health and personal mobility products. Also, Golden Technologies, Inc. cannot be held responsible for personal injury or property damage resulting from attempts to follow instructions, suggestions, and guidelines presented in this owner's manual.

Our Research and Development Department, our Quality Control Department, and our Engineering Department have used the latest product specifications and the latest product design information to manufacture your Patriot. Golden Technologies, Inc. reserves the right to implement changes into our product lines when those changes become desirable or necessary. If changes are implemented into our product line, there may be minor differences between the product you purchased and the illustrations and instructions in this owner's manual.

Please fill out and mail the enclosed warranty registration card. Registration is also available @ www.goldentech.com. We at Golden Technologies, Inc. would appreciate hearing about the dependability of your Patriot and about the convenience of mobility it has provided for you. We would also appreciate hearing about the service you received from your local Golden Technologies, Inc. dealer or representative.

Golden Technologies, Inc.
401 Bridge Street
Old Forge, PA 18518

Phone: (570) 451-7477
Fax: (570) 451-7494
Toll free: (800) 624-6374

For more information about our products and services or to send us your comments, please visit our website at www.goldentech.com

I. INTRODUCTION

FEATURES AND BENEFITS

Your Patriot™ scooter has been designed with your comfort in mind. It has also been designed to be a safe method of transportation when safety and operating instructions are followed. Please review the features and benefits of certain components of the Patriot scooter below.



Figure 1. Patriot™ (Model: GR575) Features

I. INTRODUCTION

ACCESSORIES FOR THE PATRIOT™ SCOOTER:

A variety of accessories are available for your Golden Patriot Scooter. Please contact your Authorized Golden Technologies Dealer for more information or to order.

- Cane Holder Tube
- Quad Cane Holder
- Walker Holder
- Oxygen Tank Holder
- Cup Holder
- Deluxe Pack N' Go
- Forearm Crutch Holder
- Safety Flag
- Scooter Cover
- Rear Basket
- Seat Belt

*Some accessories require a mounting bracket or mounting clips. Please check with your dealer to find out if the accessory you would like to order requires a mounting bracket or mounting clips.

Safety Guidelines

The symbols below are used in the owner's manual and/or on the product to identify warnings and to notify you of important safety information. Make sure you read and understand them completely.



WARNING! Indicate(s) a hazardous situation which, if not avoided, could result in death or serious injury. This icon is represented as a black symbol on a yellow triangle with a black border.



MANDATORY! Failure to perform mandatory actions can cause personal injury and/or equipment damage. This icon is represented as a white symbol on a blue dot with a white border.



PROHIBITED! Indicate(s) an action(s) that should not be performed under any circumstance. Failure to adhere can cause personal injury and/or equipment damage. This icon is represented as a black symbol with a red circle and red slash.

Safety Symbols

The symbols below identify warnings, mandatory actions, and prohibited actions. They can be found in the owner's manual and/or on the product. Make sure you understand all safety labels before operating the product. Do not remove safety labels from the product.



Read and follow the owner's manual!



Explosive conditions exist!



Indoor use only!



Use only AGM or Gel-Cell batteries!



Avoid transmitters!



Hot surface!



Pinch/Crush Hazard!



Do not place into trash!



Electrical hazard!



Corrosive chemicals inside battery!



Recycle



Do not use personal electronic devices!

II. SAFETY

Your Patriot™ is a battery-operated personal mobility vehicle. Please exercise caution and consideration when you are operating it. Driving your Patriot carefully and thoughtfully will help ensure your personal safety and the safety of other people.



MANDATORY! Read completely and understand this owner's manual before assembling, operating, transporting, or disassembling your Patriot scooter.

NOTICE Before learning to operate your Patriot, have your authorized Golden Technologies, Inc. dealer determine if it is advisable for you to practice getting on and off your Patriot and operating it in the presence of an attendant.

BEFORE GETTING ON YOUR PATRIOT

- Check to be certain that the power is turned off. See section V. "Operation" in this manual. This will eliminate the possibility of accidentally activating the paddle controls and causing injury to yourself and/or others.
- Check to be certain that your Patriot's freewheel lever is in the engaged position. See section V. "Operation" in this manual.
- Flip up the armrests.



WARNING When getting on or off your Patriot, keep your weight toward the middle of the deck. Putting most or all of your weight on the edge of the deck may cause an unstable condition.

GETTING ON YOUR PATRIOT

- Position the seat for safe and easy mounting. Ensure that the seat is facing forward. See Section V. "Operation."
- Return tiller to full upright position if necessary.
- Carefully place one foot on the approximate center of the deck and seat yourself comfortably and securely on the seat.
- Flip down the armrest(s.)

GETTING OFF YOUR PATRIOT

- Make certain that the power is turned off and the key is removed.
- Return tiller to full upright position
- Flip up the armrests.
- Carefully place one foot on the ground, transfer your weight to that leg, and slowly come to a standing position.
- Step away from the scooter.

MAXIMUM WEIGHT

Your Patriot has been rated to a maximum payload (operator and anything else being carried onboard) of 400 pounds. Exceeding the maximum weight rating will void the warranty.



WARNING Exceeding the maximum weight rating may result in injury to yourself and/or others.

II. SAFETY

DRIVING ON INCLINES

- For maximum stability, lean forward in your Patriot's seat while proceeding up ramps, inclines, curbs, or any low rise. See figure 2.
- Drive with caution when attempting to negotiate any incline, even handicap access ramps.
- Always climb or descend an incline by driving straight up or straight down the face of the slope. See figure 2.
- Do not traverse or drive across the face of an incline in any direction. See figure 3.
- Do not attempt to negotiate an incline that is covered with snow, ice, salt, cut or wet grass, leaves, or any other potentially hazardous material.
- Do not drive your scooter in reverse down an incline.
- Try to keep your Patriot moving when climbing an incline. If you do come to a stop, restart and accelerate slowly and carefully.
- Do not try to descend or climb a slope whose gradient is greater than recommended.

***Patriot maximum recommended incline is 7.5°.**



Figure 2. Going Up an Incline



Figure 3. Traversing an Incline

! **WARNING** If, while you are driving down a slope, your scooter starts to move faster than you feel is safe, release the throttle control lever and allow your Patriot to come to a stop. When you feel that you again have control of your scooter, push the throttle control lever forward and continue safely down the remainder of the slope.

DRIVING DOWN A DECLINE

- Lower speed setting
- Whenever it is safely possible, drive forward down any ramp, low rise, or incline.

Golden Technologies, Inc. does not recommend that you drive your scooter in reverse down any incline, ramp, curb, or low rise. Backing down any slope may create a very hazardous situation. If it is necessary to back down a slope follow one of two procedures.

II. SAFETY

▲ CAUTION When using either of the following procedures to back down a slope, Golden Technologies, Inc. strongly advises that you have the assistance of another person.

Procedure 1 - Under Power

1. Set the key switch to the “Off” position. See section V. “Operation.”
2. **Dismount your Patriot™.**
3. Set the key switch to the “On” position. See section V. “Operation.”
4. While standing alongside your scooter, carefully operate the controls at the lowest speed setting. See section V. “Operation.”
5. Slowly and carefully back your scooter down the incline.
6. Carefully remount your Patriot and resume normal operation.

! WARNING When your scooter is in freewheel mode, the park brake is released. If the batteries are dead, the motor braking system will not work. The weight of the scooter on a slope may cause you to lose control of the scooter. If you do not feel capable of manually controlling your scooter down the slope, request assistance or do not attempt to use this procedure.

Procedure 2 - Emergency (No Power)

1. Set the key switch to the “Off” position. See section V. “Operation.”
2. **Dismount your Patriot™.**
3. Set the freewheel lever to “Disengaged.”
4. While standing alongside the scooter, carefully manually maneuver it down the slope.
5. When you have reached a level surface at the bottom of the slope, position the freewheel lever in the engaged position. See figure 11 on page 20.
6. To restore power, set the key switch to the “On” position. See section V. “Operation.”

Motor Braking System

Your scooter is equipped with a system that uses the motor to aid in braking. This motor brake system is designed to work when the key is in either the on position or the off position.

When the key switch is in the on position, the freewheel is in the engaged position, and the scooter is under power, the motor will help slow down the scooter as soon as you take your hand off of the throttle lever.

When the key switch is in the off position and the freewheel lever is in the disengaged position, the motor brake system will keep you from pushing the scooter too fast (i.e. down a slope).

You may notice this when pushing the scooter. The scooter will move freely until you reach a certain speed. You will then encounter some resistance as the motor brake system is activated.

II. SAFETY

MEDICATION

Always check with your physician to determine if any of the medications you are taking may affect your judgment and/or your ability to operate your Patriot. Also check with your physician concerning your physical ability to operate a scooter.



WARNING Do not connect or allow anyone except an authorized Golden Technologies, Inc. dealer to connect any electrical or mechanical device to your Patriot. Unauthorized accessories will void the warranty and may cause injury.

NOTICE

Please remember that while on your Golden Patriot, you are a motorized pedestrian. You must observe and obey all pedestrian rules and regulations for the locale in which you are riding.

Please use your Patriot™ scooter often and allow it to expand the horizons of your daily life. The more mobility your Golden Patriot brings to you, the happier you will be, and the more satisfied we at Golden Technologies, Inc. will be! But as with all things, especially motor operated vehicles, observing a few rules and safety considerations will help ensure safe scooter operation. So please follow the rules below.

RULES FOR USE AND OTHER SAFETY CONSIDERATIONS



WARNING Read completely and understand this owner's manual before assembling, operating, transporting, or disassembling your Golden Patriot.

- **Always** operate your Golden Patriot with thought, care, and safety.
- **Do not** attempt to use your Patriot on an escalator. Always use an elevator.
- **Do not** carry passengers under any circumstances.
- **Do not** mount or dismount your Golden Patriot unless the brake is engaged.
- **Always** make sure that the key switch is set to "Off" before mounting or dismounting your scooter.
- **Do not** back your Golden Patriot down an incline or across an uneven surface.
- **Do not** turn your scooter suddenly at full speed.
- **Always** make sure the seat is locked in the forward position before operating your Patriot.
- **Always** come to a full stop before changing direction from forward to reverse or from reverse to forward.
- **Do not** operate your Patriot where you could not safely or legally walk.
- **Do not** climb ramps or curbs that exceed your scooter's capacity.
- **Always** approach curbs and inclines straight on.
- **Always** be aware of and careful near mechanical pinch points especially when assembling and disassembling your scooter.
- **Never** sit on your Patriot when it is being transported.
- **Always** fasten down your Patriot securely with an approved tie-down system while transporting your scooter.
- **Always** tie down or remove the seat during outside transport.
- **Never** operate your scooter if it is not functioning properly.

II. SAFETY

RULES FOR USE AND OTHER SAFETY CONSIDERATIONS – continued



WARNING

- **Always** use caution when driving on soft or uneven surfaces such as grass or gravel. Also use caution on decks where there is no railing.
- **Never** drive on the roadway, except when you must cross the street.
- **Always** cross streets at intersections and use crosswalks or the most direct route, making sure that your path is clear and that you are visible to motor traffic.
- **Never** drive your Patriot up or down a step or curb that is higher than the ground clearance listed on the specifications chart (see pages 14-15).
- **Never** back up or down a step or curb.
- **Do not** drive your Patriot in icy or salted conditions.
- **Never** operate your Patriot while you are under the influence of alcohol.
- **Do not** operate or store your Patriot where it will be exposed to rain, snow, mist, and below freezing temperatures.

CAUTION



Do not place hot liquids into the bottle holders. The hot liquid could spill while operating the scooter, causing you to get burned.



WARNING Should you encounter a problem with the operation of your mobility device such as a mechanical or electrical problem immediately stop using the product. Disconnect the batteries then contact the dealer from whom you purchased your mobility device for evaluation of the problem and repair if needed.

III. EMI/RFI

The rapid development of electronics, especially in the area of communications, has saturated our environment with electromagnetic (radio) waves that are emitted by television transmitters, cellular phones, citizen's band radios (CBs), amateur radios (ham radios), wireless computer links, microwave transmitters, paging transmitters, etc. These electromagnetic (EM) waves are invisible and increase in strength the closer one gets to the source of transmission. When these energy waves act upon electrical devices and cause them to malfunction or to function in an erratic or uncontrolled manner, they are referred to as Electromagnetic Interference (EMI) or Radio Frequency Interference (RFI).

EMI/RFI AND YOUR PATRIOT

All electrically powered vehicles, including scooters are susceptible to Electromagnetic Interference/Radio Frequency Interference (EMI/RFI). This interference could result in abnormal, unintended movement of your Golden Patriot.



WARNING Unintended movement or brake release could cause an accident or injury.

The FDA has determined that each make and model of scooter can resist EMI/RFI to a certain level. The higher the level of resistance, the greater the degree of protection from EMI/RFI—measured in volts per meter (V/m). The FDA has also determined that current technology is capable of providing 20 V/m of resistance to EMI/RFI, which would provide useful protection against common sources of interference. This product has been tested and has passed an immunity level of 20 V/m.

EMI/RFI RECOMMENDATIONS



PROHIBITED! Do not turn on or use hand-held personal electronic communication devices such as cellular phones, walkie-talkies, and CB radios while your scooter is turned on.

- Be aware of any nearby transmitters (radio, television, microwave, etc.) on your intended route and avoid operating your scooter close to any of those transmitters.
- Turn off the power if your Patriot is going to be in a stationary position for any length of time.
- Be aware that adding accessories or components or modifying your scooter may make it more susceptible to EMI/RFI.
- If unintended movement or park brake release occurs, turn your scooter off as soon as it is safe to do so.
- Report all incidents of unintended movement or park brake failure to Golden Technologies, Inc. Technical Service at (800) 624-6374.



WARNING Turn off your scooter as soon as it is safely possible if unintended or uncontrollable motion occurs or if unintended park brake release occurs.

IV. YOUR GOLDEN Patriot™



Figure 4. Your Golden Patriot (Model GR575)

FOR YOUR RECORDS

Please fill in your Patriot's information below. This information will be useful in the event that you ever need to contact Golden Technologies, Inc. concerning your scooter.

Model _____ Serial Number _____

Date of Purchase _____ Body Color _____

Dealer Name _____

Company _____

Address _____

City _____ State _____ Zip _____

Please remember to fill in and return your warranty registration card in the back of this manual.

IV. YOUR GOLDEN Patriot™

Specification	GR575
Medicare Code	Not Coded
Weight capacity	400 lbs.
Drive Wheels	Rear
Maximum speed	8 mph
Operating Range ¹	13 miles
Ground Clearance	3.5"
Turning Radius	76.5"
Type Batteries	2-75 AH
Colors	Red, Orange
Freewheel Mode	Yes
Electronic Speed Control	Yes
Electro-Mechanical Brakes	Yes
Mechanical Hand Brake	Yes
Charger	Off-board
Controller	PG S-140A
Dimensions:	
Length	57"
Width	28"
Height (ground to top of back of seat)	46.5" – 48.5"
Height (ground to top of back of headrest)	54" – 59"
Ground to Top of Seat	27" – 29"
Ground to Top of Deck	8.75"
Deck to Top of Seat	18" – 20"
Number of Seat Height Positions	3
Size of Increments	1"
Front axle to Rear axle	40"
Weight of Unit: (assembled)	
Base	158 lbs.
Seat with Arms	50 lbs.
Batteries	52 lbs./ea.

IV. YOUR GOLDEN Patriot™

Specification	GR575
Tires:	Solid, low profile
Front	13"
Rear	13"
Rear Anti-Tip Wheels	N/A
Standard Seat:	Captain's Highback
Slide Seat	N/A
Back Height (no headrest)	21 in.
Back Height (with headrest)	28.5" – 31.5"
Width x Depth (adjustable depth is standard, set to 18")	20" x 18"/20"
Color	Charcoal/Gray
Warranty:	
Frame	Five Years
Drive Train	1 Year
Electronics ²	1 Year

*** Notes:**

1. Battery range will vary due to rider weight, drive surface, and terrain.
2. Electronics warranty excludes batteries.

Literature is current at the time of printing. Golden Technologies reserves the right to make changes to the product or literature at any time.

V. OPERATION



Figure 5. Patriot™ Delta Tiller Control Panel

CONTROL PANEL

Speed Adjustment Dial

- The speed adjustment dial allows you to pre-select the maximum top speed of your Golden Patriot. See figure 5.
- Turn the dial counterclockwise to operate your scooter at the lowest speed level.
- Turn the dial clockwise to increase the operational speed of your scooter.
- We recommend that you select a speed setting at which you feel comfortable, safe, and in control of your Patriot.

Key Switch

This switch turns the power on and off to your Patriot. See figure 5.

- Insert the key into the key switch.
- Turn the key 90 degrees clockwise to turn on your scooter's power. The DC Battery Voltage Meter will light up, and the needle will move to indicate that power is on.
- Turn the key back to the vertical position to turn off your scooter's power.

CAUTION

Always make certain that the key is removed from the key switch before getting on or off your Golden Patriot or before lowering the tiller completely.

Horn Button

Press this button to sound the horn. See figure 5.

V. OPERATION

DC Battery Voltage Meter

This meter (see figure 5) shows the amount of voltage in your Patriot's batteries.

- Green indicates a full charge on the batteries.
 - Yellow indicates caution and approximately a one-half charge of the batteries.
 - Red indicates that the batteries have less than one-half of a charge remaining.
- See section X. "Care and Maintenance" for instruction concerning charging the batteries.

Delta Tiller Throttle Control Lever

The Delta Tiller enables you to use only one hand (either the right or left) to operate both the speed and the direction of the Patriot. This self-centering lever system controls your Patriot's speed (up to the maximum speed set by the speed adjustment dial) and its forward and reverse direction. See figure 5.

To drive forward use either of the following:

- Use your right hand fingers to pull back on the right side of the throttle control lever.
- Use your left thumb to push the left side of the throttle control lever.

CAUTION

Always bring your Patriot to a full stop before changing direction from forward to reverse, or from reverse to forward.

To drive in reverse use either of the following:

- Use your left hand fingers to pull back on the left side of the throttle control lever.
- Use your right thumb to push the right side of the throttle control lever.

When the throttle control lever is completely released, it automatically returns to the center "stop" position and engages your scooter's brakes, bringing you to a complete stop. You will hear a "click" when the park brake engages.

Control Options

Golden Technologies, Inc. has made provision for the individual needs and abilities of the operators of the Golden Patriot.

Your authorized Golden Technologies, Inc. dealer can reverse the throttle control lever controls so that when you pull on the left side of the lever, your scooter will move in the forward direction, and when you pull on the right side of the lever your scooter will move in the reverse direction.

DELTA TILLER ADJUSTMENT

The tiller on your Patriot scooter employs a handle to provide you with infinite tiller angle settings. To set the tiller to your liking, follow these directions.

1. Use one hand to grasp and squeeze the tiller handle.
2. While squeezing the handle, position the tiller to a comfortable driving position.
4. Release the handle to lock the tiller in place.

V. OPERATION

SEATING

Armrest Width Adjustment

To adjust the armrest width:

1. Loosen the adjustment knobs at the rear of the seat. See figure 6.
2. Slide the armrests in or out to the desired width.
3. Tighten the adjustment knobs.



Figure 6. Armrest Width Adjustment



WARNING Be sure the adjustments knobs are securely tightened against the inserted armrest tube. Do not overextend the armrest.

Flip-up Armrests

Pull up on the end of either armrest to flip it up for easy transfer on and off your Golden Patriot™. See figure 7.

Armrest Angle

To increase the armrest angle, turn the armrest angle screw counterclockwise.

To decrease the armrest angle, turn the armrest angle screw clockwise. See figure 7.

Armrest Height

1. Loosen “Armrest Height Adjustment Knob” (Figure 7) until you can pull it outward.

Note: The knob is retained in its housing with a spring.

2. While keeping the knob pulled, raise or lower the armrest to the desired position then release the knob. After releasing the knob, you may have to raise or lower the armrest until it aligns with the nearest locking position.

3. Tighten the height adjustment knob.

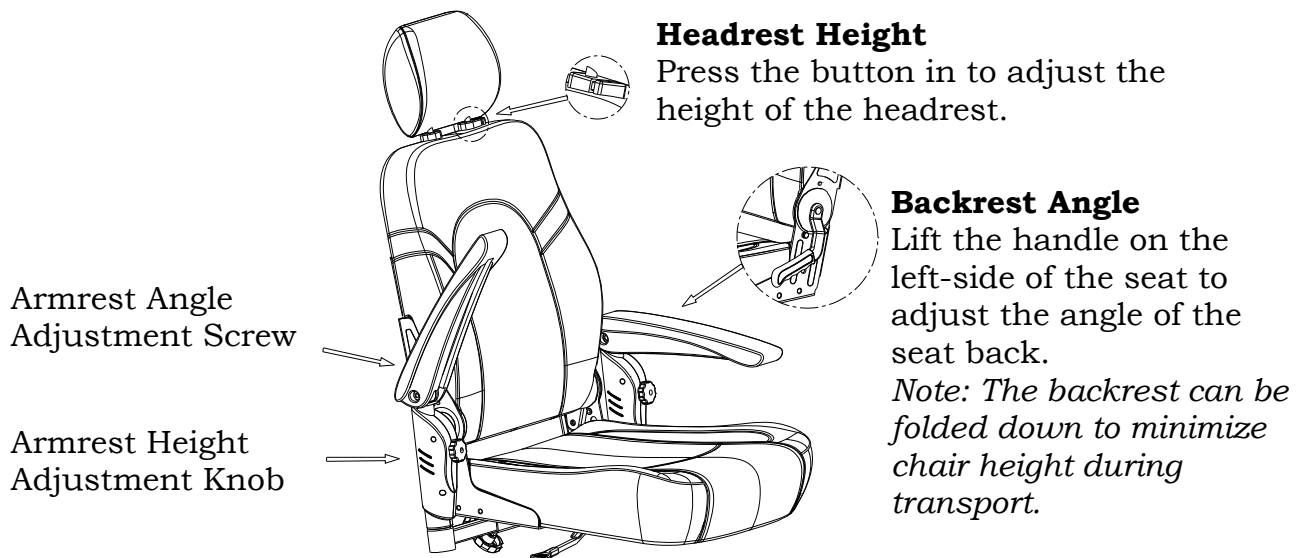

Headrest Height

Press the button in to adjust the height of the headrest.

Backrest Angle

Lift the handle on the left-side of the seat to adjust the angle of the seat back.

Note: The backrest can be folded down to minimize chair height during transport.

Figure 7. Seating Comfort Adjustments

V. OPERATION

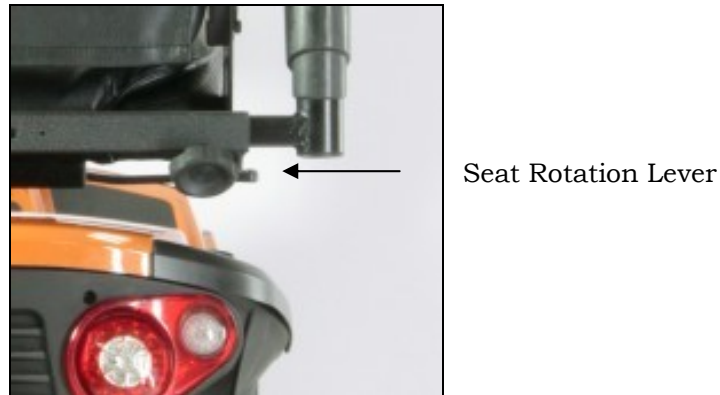

Figure 8: Seat Rotation Adjustment

Seat Rotation Lever

The seat can be rotated through 360° and locked at any 45° position.

1. Push down on the seat rotation lever and rotate the seat to the desired position. See figure 8.
2. Release the handle to lock the seat at any 45° position.



Figure 9

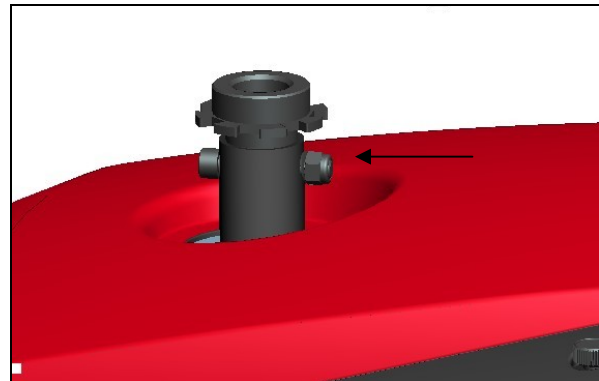

Figure 10 Seat Post Nut and Bolt

Seat Height Adjustment

To adjust the seat height:

1. Fold the seat back down, grasp the seat on both sides and lift the seat up and off of the seat pedestal. See Figure 9. (*Note: Seat arms can be removed to reduce the seat weight*).
2. Remove the nut and bolt that holds the seat post in the seat pedestal. See Figure 10.
3. Position the seat post at the desired height while aligning the holes in the seat post and the seat pedestal.
4. Reinstall the nut and bolt.
5. Place the seat back onto the seat post, and push down to lock the seat.



WARNING Make sure the seat is securely locked into place before operating the scooter.

V. OPERATION

 **WARNING** Never sit on your Patriot in freewheel mode.

 **WARNING** Never disengage the park brake while you are operating your Patriot.

 **WARNING** Always make certain that your scooter park brake is engaged before inserting the key into the key switch and turning it to the on position.

FREEWHEEL MODE

Your Patriot™ is equipped with a freewheel lever that can set your scooter in or out of freewheel mode.

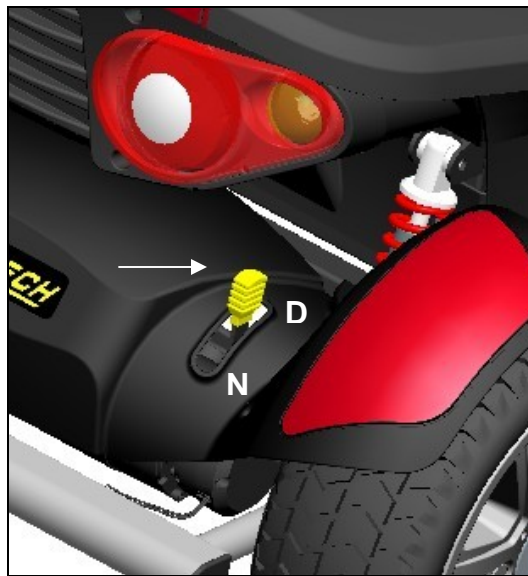

Figure 11: Freewheel Lever

To disengage the park brake and put your scooter in freewheel mode:
Pull back on the freewheel lever towards the letter N (Neutral Position). See figure 11.

To engage the brake and take your scooter out of freewheel mode:
Push forward on the freewheel lever towards the letter D (Drive Position). See figure 11.

NOTICE Pushing the scooter too quickly in freewheel will cause the motor to act as a generator causing the scooter to become difficult to push. Freewheel slowly.

VI. RIDING YOUR Patriot™

MOUNTING

CAUTION

For your first driving session, make certain that your Patriot™ starts out on a level surface and that you will continue driving on a level surface.

BEFORE GETTING ON YOUR PATRIOT

1. Check to be certain that the key has been removed from the key switch. See section V. "Operation" in this manual. This will eliminate the possibility of accidentally activating the paddle controls and causing injury to yourself and/or others.
2. Check to be certain that your Patriot™ freewheel lever is in the engaged position. See section V. "Operation" in this manual.
3. Flip up or remove the armrests.



WARNING When getting on or off your Patriot™, keep your weight toward the middle of the deck. Putting most or all of your weight on the edge of the deck may cause an unstable condition.

GETTING ON YOUR PATRIOT

1. Position the seat for safe and easy mounting. Ensure that the seat is facing forward. See Section V. "Operation."
2. Return tiller to full upright position if necessary.
3. Carefully place one foot on the approximate center of the deck and seat yourself comfortably and securely on the seat.
4. Flip down or replace the armrest(s.)
5. Place the key into the key switch. See figure 5 on page 16.
6. Rotate the key clockwise to the on position.

VI. RIDING YOUR Patriot™

BASIC DRIVING

1. Make certain that you are seated safely and properly on your Golden Patriot.
 2. Turn the speed control dial fully counterclockwise to its slowest setting.
 3. Insert the key into the key switch—if you have not already done so.
 4. Turn the key clockwise to the “On” position.
 5. Place your hands on the handgrips.
- If you wish to drive forward, pull back on the right side of the throttle control lever (or push the left side of the throttle control lever forward.)
 - If you wish to drive in reverse, pull back the left side of the throttle control lever (or push the right side of the throttle control lever forward.)
6. Pull on the throttle control lever to gently accelerate your Patriot.
 7. Release the throttle control lever to allow your Patriot to come gently to a full stop.
 8. Practice these two basic functions until you feel that you have control of your scooter.

Steering

Steering your Golden Patriot is easy and logical.

1. With both hands on the handgrips of the tiller (see figure 4 on page 13), turn the tiller to the right to travel to the right.
2. With both hands on the handgrips of the tiller (see figure 4 on page 13), turn the tiller to the left to travel to the left.
3. Make certain to maintain sufficient clearance when turning your scooter so that the rear wheels will clear any obstacle.



WARNING Turning your scooter too sharply at too high a speed may create a situation where one of the wheels will leave the ground. This may increase the possibility of tipping the scooter. Avoid this danger at all times by decelerating and steering a wide arc around corners and obstacles.

VI. RIDING YOUR Patriot™

Steering in a Tight Spot

If you must steer in a tight spot, such as entering a doorway or when turning around:

1. Bring your Patriot to a full stop.
2. Set speed at the lowest setting.
3. Turn the tiller to the direction in which you wish to drive.

For more information on dealing with obstacle and tight spots, see “Control Through Tight Spots” on the next page.

Steering in Reverse

Backing up your Patriot requires attention to what you are doing.

1. Use your right fingers to push the throttle control lever or use your left fingers to pull back on the throttle control lever. See figure 5 on page 16.
2. Turn the tiller to the left to drive in reverse to the left.
3. Turn the tiller to the right to drive in reverse to the right.

NOTICE Your Patriot’s speed in reverse is fifty percent of the forward speed set at the speed control dial.



WARNING

Prevent injury! Do not drive down an incline in reverse.

VI. RIDING YOUR Patriot™

CONTROL THROUGH TIGHT SPOTS

As you use your Golden Patriot to greatly increase your mobility, you will undoubtedly encounter some obstacles that will require practice to negotiate smoothly and safely. Below are some common obstacles that you may meet during the daily use of your scooter. Listed with those obstacles are some driving tips that should help you conquer those obstacles. Learn and follow those tips, and with surprising ease you will soon be in control of your Patriot as you maneuver it through doors, up and down ramps, up and over curbs, through grass and gravel, and up and down inclines.

Ramps

When proceeding up any ramp, curb, or incline:

- Lean forward in your seat to move your center of gravity forward for maximum stability and safety. If the ramp has a switchback, good cornering ability is required.
- Maneuver your Patriot so that the front wheels take wide swings around the corners of the ramp.
- Doing this will allow your scooter's back wheels to follow a wide arc around the corner, staying clear of obstacles.

If you must stop your Patriot while driving up a ramp:

- Starting up again simply requires that you apply gentle and steady forward power pressure to the throttle control lever.
- Accelerate gently after stopping on any incline.

Driving down a ramp:

- Keep your Patriot's speed control dial set fully counterclockwise at the slowest speed setting.
- If you must come to a stop, release the throttle control lever slowly and smoothly.



WARNING Prevent injury! Do not drive down an incline in reverse.

Curbs

- See specifications for maximum curb height.
- Always use caution when negotiating any curb.
- Go up or down a curb head on at a direct 90° angle.
- Approach and negotiate the curb so that both back wheels of your scooter go over the curb at the same time.
- Never negotiate inclines or curbs by traversing them. Doing so may cause the scooter to tip over.
- Go down a curb slowly to avoid a jarring bump. Use as little power as possible.

Grass and Gravel

Your Golden Patriot performs admirably on grass, gravel, and hills, but you must follow the operational parameters presented in this manual. Refer to the "Safety" section. If you are unsure about any situation, avoid it. Common sense is your best protection.

- Feel free to use your Golden Patriot on lawns or in park areas.
- Avoid long or high grass, which may wrap around your scooter's axles.
- Avoid loose gravel.

VII. DISASSEMBLY

DISASSEMBLY

When disassembling your scooter, please be sure to follow these simple instructions.

Remove the Seat

1. Place your scooter on a level surface.



WARNING Remove the key from the key switch before you begin to disassemble your Patriot.

2. (Optional) Loosen the armrest adjustment knobs and remove the arms from the seat. This will reduce the weight of the seat making it easier to lift.



WARNING Never pull on the arms or use them as a handle to move the scooter as they could inadvertently pull out of the receiver bar causing injury.

3. Grip the seat on opposite sides and, with a firm grip; pull the seat straight up. See figure 12.



Figure 12. Removing the Seat

Remove the Batteries

4. Remove the four knob screws securing the battery cover, and then remove the cover. See figure 13.
5. Remove the Velcro strap from each battery, and then unplug the batteries from the scooter.
6. Lift the batteries (2) out of the scooter.



Figure 13. Removing the Batteries

VII. DISASSEMBLY

Remove the Tiller Basket

7. Remove the tiller basket by pulling up.

Fold Down and Lock the Tiller

8. Use one hand to grasp and squeeze the tiller handle. While squeezing the handle, fold the tiller down and release the handle to lock the tiller in place. This will lock the front wheels to keep them from turning side to side to help control while carrying or transporting the scooter. See figure 14.



WARNING The Patriot™ scooter weighs approximately 158 lbs. with the seat, batteries, and tiller basket removed. Exercise good judgement when moving or lifting the scooter.



WARNING! Be aware of labeled pinch-points! Be careful not to pinch your fingers between moving or removable parts during the disassembly of your scooter. Your full attention is required!

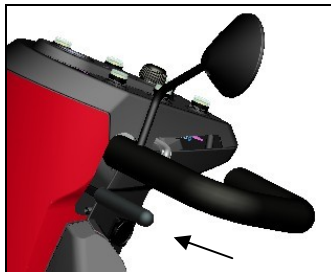

Tiller Handle



Figure 14. Lowered Tiller

VIII. ASSEMBLY



WARNING! Be aware of any possible pinch-points! Please note warning labels at pinch-points during assembly.



WARNING! Pinching and crushing hazard! Increased hazards due to pinching or crushing result due to the component weight (such as batteries) during preparation for transport and maintenance work. Always carry out any work to be done with great care. Always try to get help from a second person, especially when stowing parts for transport.



WARNING! Pinch Point: A pinch point is an area where you **MUST** consider your fingers to be sure they **DO NOT** become pinched between two metal or hard plastic areas. The greatest chance of pinch points becomes possible during the assembly of the Patriot scooter.



WARNING INJURY HAZARD DUE TO IMPROPER ASSEMBLY!

Ensure that all components in the scooter have been correctly assembled. During assembly, please check that all connecting/locking devices are holding in place.



Figure 15. Patriot Components (Model GR575)

VIII. ASSEMBLY

Install the Batteries

1. Gently lower the batteries (2) into the battery compartment, and secure each battery down with a Velcro strap. See figure 16.
2. Plug the battery cables (2) into their matching color coded connectors on the scooter.

Install the Battery Cover

3. Place the battery cover over the batteries and secure with the four knob screws.

Install the Seat

4. Hold the seat on an angle so you can see the seat swivel post underneath.
5. Place the seat swivel post into the seat receiver post as shown in figure 17.
6. Push down on the seat to lock the seat in place. Move the seat from side to side to make sure it is locked in place.



Figure 16. Battery Installation



WARNING! Pinch Point!

Keep hands and clothing clear of the seat swivel post and seat post.

WARNING! Accident hazard due to non-engaged seat!

Ensure that the seat is properly engaged by turning the seat slightly left and right.

Figure 17. Installing the Seat

Unlock the Tiller

7. Use one hand to grasp and squeeze the tiller handle. While squeezing the handle, lift the tiller up to the desired position and release the handle to lock the tiller in place. See figure 14 on page 26.

Install the Tiller Basket

8. Place the basket onto the tiller bracket and push down to lock it in place.



WARNING **Accident hazard due to incorrect seat position!** Always turn the seat to face forwards and engage it before driving. If the seat is in any other position, the possibility of tipping is increased. Before turning the seat, always ensure that the scooter is on an even and solid surface.

IX. TRANSPORTING YOUR Patriot™



Golden Patriot™

NOTICE

The Golden Patriot™ can be equipped with a docking device for loading onto a vehicle by means of a mechanical lift or hoist. Contact your Golden Technologies, Inc. dealer for more information concerning docking devices and scooter lift devices.

To Transport Your Patriot:

- Disassemble or fold down the seat and tiller (see section VII. “Disassembly”) as close as possible to the loading area of the vehicle to be used for transporting your scooter.
- The degree to which you disassemble your Patriot or fold the seat and tiller depends on the size and shape of the cargo area of the transporting vehicle.
- Moving blankets or other forms of padding may be used to protect your Patriot™ during transportation.

CAUTION

- Do not lift your Patriot by its plastic body parts or dash. Breakage of these parts is not covered by the warranty.
- Do not use the tires or wheels to lift the rear carriage. The carriage may rotate and cause injury or damage.



WARNING If your scooter and its components are not properly and securely stowed during transportation, the scooter or the components may move or become airborne and cause injury or damage.



WARNING Never sit on your Patriot when it is being transported. Always fasten down your Patriot securely with an approved tie-down system while transporting your scooter.



WARNING If transporting your scooter on an outside lift, remove the seat or make sure the seat is fasten down securely with an approved tie-down system supplied by your lift manufacturer while transporting your scooter. Failure to do so could result in the seat coming loose and becoming airborne. This situation could cause problems for the traffic behind you and possibly result in an injury.

X. CARE AND MAINTENANCE

ROUTINE MAINTENANCE

The Patriot™ is virtually maintenance free. All of the bearings on your Golden Patriot are permanently lubricated and sealed. No additional lubrication is required. There are, however, several things that you can do to help keep up the appearance and maintain the performance of your scooter.

CLEANING YOUR PATRIOT™

Tires

- Clean the tires with ordinary kitchen-type cleaners and a damp cloth.
- Do not use solvents on the tires. Solvents can cause the tire material to break down or become too soft.

Body

The body shrouds of your scooter are formed ABS plastic and are painted for style and durability.

NOTICE

Do not use excess water or pressure when cleaning your scooter.

- Never take your scooter through a car wash.
- Never use a high pressure hose to wash your scooter.
- Use cool water mixed with a mild soap to remove dirt and oils. Dry with a clean soft cloth.
- Buff by hand with a soft cloth.
- Do not use a sharp object when removing shroud pieces.
- Clean the body of your scooter with a damp cloth.

Vinyl Seat

Clean with a mild soap or mild detergent and a damp cloth. A vinyl cleaner may also be used.

CAUTION

Never use silicone tire products on tires as it may cause tire slippage.

Rubber Floor Mat

The rubber floor mat snaps into place on the scooter floor. Simply pull up on the mat to remove it.

- Clean the floor mat with ordinary kitchen-type cleaners and a damp cloth.
- Do not use solvents on the floor mat. Solvents can cause the material to break down.

X. CARE AND MAINTENANCE

IMPORTANT! New batteries **MUST** be fully charged prior to the initial use of your scooter. **Charge new batteries for 12 hours even if the battery gauge already shows a full charge. This is to condition your new batteries for maximum performance.**



WARNING! Corrosive chemicals contained inside the battery.
Explosive battery conditions exist.



WARNING! Charger surface can become HOT.
Electrical hazard!

BATTERIES AND CHARGING

Battery maintenance is the most important part of maintaining your scooter. Keeping the batteries fully charged helps to extend battery life. Use the following guidelines to help keep your batteries in optimum condition.

- For daily use, keep batteries fully charged. We recommend that you plug in the off-board charger after each use and charge 6-8 hours.

“For best results please charge your batteries overnight after every use.”

- If you are not going to use the scooter for more than a week, **fully charge** the batteries and then disconnect them from the scooter. See figure 13 on page 25.

Charging Guidelines Checklist to Maximize Battery Life

- ✓ Use only the automatic off-board charger supplied for all routine charging.
- ✓ Never use an automotive or wet type charger.
- ✓ Avoid deep discharges and never drain the batteries completely.
- ✓ Do not leave batteries in a low state of charge for extended periods. Charge a discharged battery as soon as possible.
- ✓ Fully recharge batteries regularly.
- ✓ Always store batteries fully charged.
- ✓ Check stored batteries once a month and recharge as necessary.

To Charge the Batteries:

The charger for all Patriot models is an off-board charger. To charge the batteries, lift the cover and plug the charger into the charger port on the tiller. See figure 18. When the batteries are fully charged, disconnect the charger power cord from the wall outlet and from the charging socket.

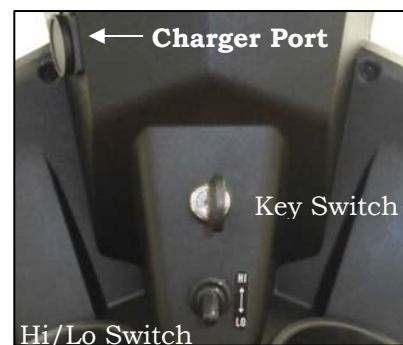

Figure 18. Battery Charging

NOTICE Your scooter will not move while the charger remains connected.



Battery Maintenance

MANDATORY! Use only AGM or GEL-cell batteries. GEL-cell or AGM and SLA deep-cycle batteries are used for operating the Golden Patriot.

- These batteries are maintenance free.
- There is no danger of spillage or leakage, so these batteries are safely transportable on aircraft, busses, trains, etc.
- By following the procedures set out in this manual, you can expect extended life from your Golden Patriot's batteries.

X. CARE AND MAINTENANCE

IF YOUR Patriot™ DOES NOT OPERATE

- Make certain the freewheel lever is set to the engaged position. See page 20.
- Check the main circuit breaker. If necessary, reset the circuit breaker. See figure 19.
- Make certain that the speed adjustment dial is at the desired setting.
- Make certain that the key switch is set to the “On” position.

If none of the above procedures solve the problem, contact your authorized Golden Technologies, Inc. dealer.

MAIN CIRCUIT BREAKER

The main circuit breaker reset button is located under the seat in front of the battery cover. See figure 19.



WARNING! Do not attempt electrical repairs.

Consult Golden Technologies, Inc. or your authorized Golden Technologies, Inc. dealer. If, for no apparent reason, your Patriot stops operating, the main circuit breaker may have tripped.

Possible causes for the main circuit breaker to trip:

- Driving up a long, steep hill.
- Driving over a curb.
- Run-down batteries.

As you operate your Patriot, battery voltages go down and battery current must rise to satisfy the demands of the motor and of other electrical devices operating on your scooter. This can cause a heavy current draw that will trip the main circuit breaker.

Remedy:

- Recharge your Patriot’s batteries. See “Batteries and Charging” on page 31.
- If the problem continues, have your authorized Golden Technologies, Inc. dealer load test the batteries.
- If the batteries are good, the charger may be the problem. Consult your authorized Golden Technologies, Inc. dealer.

Resetting the Main Circuit Breaker

1. If the main circuit breaker trips as a result of run-down batteries or because of a temporary overload, reset the circuit breaker:
2. Wait ten minutes or so for the motor control board to return to the normal operating temperature range.
3. Make certain that the key switch is set to the “Off” position.
4. Press in on the main circuit breaker reset button. See figure 19.

NOTICE If the main circuit breaker continues to trip, there is probably an underlying electrical fault that needs attention.

- Contact your authorized Golden Technologies, Inc. dealer.
- Do not keep resetting the main circuit breaker without correcting the underlying electrical problem.

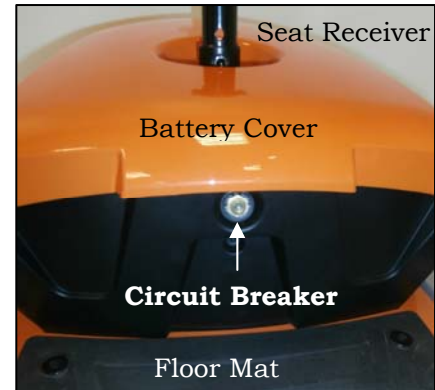

Figure 19. Circuit Breaker

X. CARE AND MAINTENANCE

DIAGNOSTICS

The diagnostics feature of your Golden Patriot microprocessor based motor control board functions as follows:

- Any fault condition with the controller or with an associated system will cause the scooter to beep.
- The number of beeps in each series is referred to as the “Beep Code.”
- The beep code indicates the nature of the condition or fault.

BEEP CODES

The S-Drive controller uses audible beeps to indicate the status of the system. When the controller notices that there is a malfunction in the system, it will beep a code when the power is on. The signal will be a set of fast beeps lasting two seconds. The slower diagnostic pattern will then be sounded once. For example, when it Beeps five times and stops, that indicates BEEP code #5 – Brake Trip.

The following BEEP codes are used to help diagnose system errors:

- BEEP Code #2 – Low Battery Voltage
- BEEP Code #3 – High Battery Voltage
- BEEP Code #5 – Solenoid Brake Trip
- BEEP Code #6 – Throttle Trip
- BEEP Code #7 – Throttle Trip
- BEEP Code #8 – Motor Disconnected
- BEEP Code #9 – Possible Controller Trip

BEEP CODE #2 – LOW BATTERY VOLTAGE

The battery needs charging or there is a bad connection to the battery. Check the connections to the battery. If the connections are good, try charging the battery.

BEEP CODE #3 - HIGH BATTERY VOLTAGE

An excessive voltage has been applied to the S-drive. This is usually caused by a poor battery connection. Check the battery connections. *NOTE: The error may only be present when going down hill and power goes back to the batteries.*

BEEP CODE #5 – SOLENOID BRAKE TRIP

The parking brake has a bad connection. Check the parking brake and motor connections. Make sure all the system connections are secure.

X. CARE AND MAINTENANCE

BEEP CODE #6 – THROTTLE TRIP (OUT OF NEUTRAL)

A throttle trip is indicated. Make sure the throttle is in the neutral position before switching on the scooter.

BEEP CODE #7 – THROTTLE TRIP/SPEED CONTROL FAULT (VOLTAGE ERROR).

A throttle trip is indicated. Indicates a problem with the throttle control or speed control.

BEEP CODE #8 - MOTOR DISCONNECTED

The motor has a bad connection. Check all the connections and leads between the motor and the S-drive. Check the position of the freewheel switch.

BEEP CODE #9 – POSSIBLE CONTROLLER TRIP

A control system trip is indicated. Make sure all connections are secure.

NOTICE FOR YOUR CONVENIENCE, THESE DIAGNOSTIC BEEP CODES ALONG WITH THE SERIAL NUMBER OF YOUR SCOOTER CAN BE FOUND UNDER THE FLOOR MAT. THIS WILL ALLOW YOU TO ACCESS THIS IMPORTANT SERVICE INFORMATION AT ANY TIME. IF POSSIBLE, PLEASE REFER TO THIS INFORMATION BEFORE CONTACTING YOUR AUTHORIZED GOLDEN TECHNOLOGIES, INC. DEALER.

XI. WARRANTY



Consumer Limited Warranty Scooters Effective June 1, 2008

The following warranty is granted only to the INITIAL Consumer who has purchased our product and commences on the Date of Purchase by the Consumer from an Authorized Golden Technologies' Provider. The Consumer must have a warranty registration card filed with Golden Technologies to receive service. This warranty supersedes all previous warranties for all scooter models effective June 1, 2008.

The warranty covers the following scooter model unless otherwise noted:

- ◆ Patriot GR575

Five-Year Warranty:

For five years, from the date of purchase from an authorized Golden Technologies' dealer, in the event of defective materials or workmanship, Golden Technologies will repair or replace at our option any of the following structural components found to be defective by an authorized Golden Technologies representative:

- ◆ Steel Frame
- ◆ Frame Welds
- ◆ Tiller Frame
- ◆ From Front Fork
- ◆ Seat Post

One-Year Warranty:

For the period of one year from the date of purchase, in the event of defective materials or workmanship, Golden Technologies will repair or replace at our option with any new or reconditioned components any of the following drive train components found to be defective by an authorized Golden Technologies representative:

- ◆ Transaxle
- ◆ Motor/Brake Assembly (electrical function only)

Note: An increase in operating noise of the transaxle DOES NOT constitute a defect. With normal wear and tear, operating noise is expected to increase.

For the period of one year from the date of purchase, in the event of defective materials or workmanship, Golden Technologies will repair or replace at our option any of the following electronic assemblies found to be defective by an authorized Golden Technologies representative:

- ◆ Electronic Controller
- ◆ Battery Charger
- ◆ Dash Assembly
- ◆ Potentiometer Assembly
- ◆ Wire Harness(es)

NOTICE While charging batteries, it is normal for the battery charger to heat up. Heat coming from the battery charger DOES NOT constitute a defect.

XI. WARRANTY

Golden Technologies' Consumer Limited Warranty *Scooters (continued)*

One-Year Limited Warranty:

For the period of one year from the date of purchase, in the event of defective materials or workmanship, Golden Technologies will repair or replace at our option any of the following parts found to be defective by an authorized Golden Technologies representative:

- | | | |
|-------------------------|---------------------|----------------------|
| ◆ Bearings | ◆ Rubber Components | ◆ Plastic Components |
| ◆ Bushings | (excludes tires) | (excludes body) |
| ◆ Seat Swivel Mechanism | ◆ Armrests | |

Items not listed are covered at the discretion of Golden Technologies. Any accessories, standard or optional, supplied by Golden Technologies, are covered for a period of one year from the date of purchase with the particular unit.

Warranty Exclusions:

Golden Technologies does not provide warranty on any of the following items which may require replacement due to the normal wear and tear of day to day usage:

- | | | |
|-----------------------|-----------------|--------------|
| ◆ Tires and Tubes | ◆ Motor Brushes | ◆ Brake Pads |
| ◆ ABS Plastic Shrouds | ◆ Bulbs/Fuses | ◆ Upholstery |
| ◆ Armrest Pads | | |

This warranty also excludes the following:

- ◆ Batteries (Please consult battery manufacturer for any implied warranty)
- ◆ Loss or theft of components
- ◆ Damage caused by:
 - ◆ Battery fluid spillage or leakage
 - ◆ Abuse, misuse, accident or negligence.
 - ◆ Improper operation, maintenance or storage.
 - ◆ Commercial use or use other than normal.
 - ◆ Repairs and/or modifications made to any part without the specific consent of Golden Technologies.
 - ◆ Exceeding the specified weight capacity of the unit.
 - ◆ Accessories other than those supplied or approved by Golden Technologies.
 - ◆ Failure to adhere to the product instructions
 - ◆ Acts of Nature, such as lightning strikes, earthquakes, etc....
 - ◆ Circumstances beyond the control of Golden Technologies.

- ◆ **ANY PARTS ALTERED OR REPAIRED BY UNAUTHORIZED PERSON.**

Warranty Service:

Warranty Service must be performed by an authorized Golden Technologies representative. Golden Technologies reserves the right to replace warranted part(s) with refurbished or new part(s) at our discretion. All labor charges, service calls, transportation costs or any other charge(s) associated with the installation of any warranted part(s) are the responsibility of the consumer. Warranty is for the replacement of the parts only and does not include freight for the replacement parts. Consumers are not to return any item(s) to Golden Technologies without prior written authorization. Any damages incurred while warranted part(s) are in transport are the sole responsibility of the consumer.

There is no other express warranty.

Implied warranties, including those of merchantability and fitness for a particular purpose are excluded. Liabilities for consequential damages are excluded. This warranty gives you specific rights and you may also have other rights which may vary from state to state.

XII. WARRANTY/REGISTRATION FORM

Golden Technologies Product Registration Form

Please fill out this product registration form or you can also register your product online at www.goldentech.com. Failure to register your product may result in significant delays should service be required.

OWNER INFORMATION:

Name: _____

Address: _____

City: _____ State: _____ Zip: _____

PRODUCT INFORMATION:

Serial Number: _____

Purchased From: _____

City: _____ State: _____ Zip: _____

Date Purchased: _____

MAIL COMPLETED FORM TO:

Golden Technologies
401 Bridge St.
Old Forge, PA 18518

Fold Here First

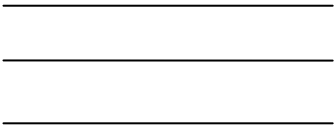
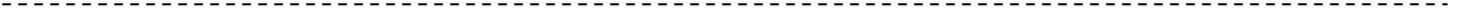

Place
Stamp
Here

Golden Technologies
401 Bridge St.
Old Forge, PA 18518

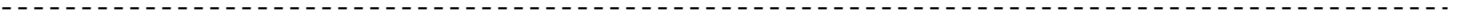

Fold Here Second

Golden
Patriot™



Model GR575



401 Bridge Street
Old Forge, PA 18518
Tel: 800-624-6374
Fax: 800-628-5166
www.goldentech.com