

Power Lift & Recline Chair

OWNER'S MANUAL MAXICOMFORT™ MODELS



The Best Power Lift and Recline Chair Made in the USA 

 **GOLDEN**
technologies
YOUR LIFE IN MOTION

401 Bridge Street
Old Forge, PA 18518
www.goldentech.com



Dear Valued Customer,

Thank you for purchasing this Golden Technologies Power Lift and Recline Chair. Your Golden chair is tested and certified by NRTL Met Labs to UL and CSA electrical standards to assure that you have purchased one of the safest chairs available.

We believe that this product is made from the highest quality components available, is engineered to give you maximum service with minimum maintenance, and is backed up by the strongest warranty in the industry. We hope that you enjoy years of pleasurable use of your Golden Technologies chair and that this chair becomes a true assist to you in both sitting down and standing up.

Please take a few moments to review this manual to become familiar with the operation of this chair and our warranty. If you need additional information, please call the dealer from whom you purchased this chair.

Also, please note the following safety information: This power lift and recline chair is a medical device designed to help you sit down and stand up. Do not allow children to operate the chair at any time. When not in use, the chair should be kept in the sitting position.

Again, thank you for selecting this Golden chair.

Sincerely,

Robert Golden
Chairman and Founder



Complies with UL 73
and CSA C22.2 No. 68

Listing # E112417



IMPORTANT!















READ THIS MANUAL FIRST BEFORE INSTALLING OR OPERATING YOUR POWER LIFT AND RECLINE CHAIR.

Your power lift and recline chair has been engineered from the leg levelers up to provide the ultimate in strength and reliability.

Great care has been taken to provide you with total comfort and safety. Golden Technologies thoroughly inspects and tests each unit prior to shipment.

Your Golden power lift chair is a medical device. Therefore, you are required to exercise caution when operating it to ensure your personal safety and that of others around you. The following are rules for the safe operation of your Golden power lift chair.

WARNING

-  Care should be taken in the unpacking of this unit, so as not to cause injury to persons or damage to the unit. Dispose of all plastic bags and covers, as they can be a smothering hazard to small children.
-  Do not allow children or pets near the chair while the chair is operating.
-  Do not allow children to play with or operate the chair at any time.
-  Hand control should be unplugged and placed out of reach of children when the chair is not in use.
-  Do not flop down into the chair when getting into it, or while it is in its lift position. Flopping down into the chair will damage it and could cause personal injury.
-  Do not allow anyone to sit on your lap, or on the arm of the chair, or on the footrest while operating the chair, as it may cause tipping and could result in personal injury.
-  Do not place fingers or hands between the seat cushion and the inside arm of the chair while sitting in the chair or when the chair is in operation or plugged into a power source.
-  Do not retrieve fallen objects from inside or under the chair while the chair is plugged into a power source.
-  Do not operate chair if there are any persons, pets or other obstructions under or in front of the footrest, under the chair or behind the chair.
-  Do not smoke while operating, sitting or resting in the chair.
-  To reduce risk of electrical shock, do not immerse any of the electrical components into a liquid, or spill any liquids onto electrical components. Do not open any of the electrical components. There are no serviceable parts.
-  Warranty will be void if any of the electrical components are opened by other than a qualified service person.
-  Make sure the chair is placed at the specified distance from a wall/corner (page 4). Failure to do so can damage the chair and will void the warranty.
-  Do not use any type of electrical extension cord to plug your chair into an electrical outlet.

INSTALLATION MAXICOMFORT MODELS

1. Remove the transformer from the transformer box (located behind the lower outside back) and install two 9 volt alkaline batteries into the sockets on the transformer. Place transformer on the floor behind the chair.
2. Plug the transformer into a 115-120V 60Hz A.C. outlet and connect the power cable from the chair into the transformer as shown. Power cable is located under the chair attached to the motor shaft with white zip tie. Remove zip tie, extend cable under and out behind the chair.

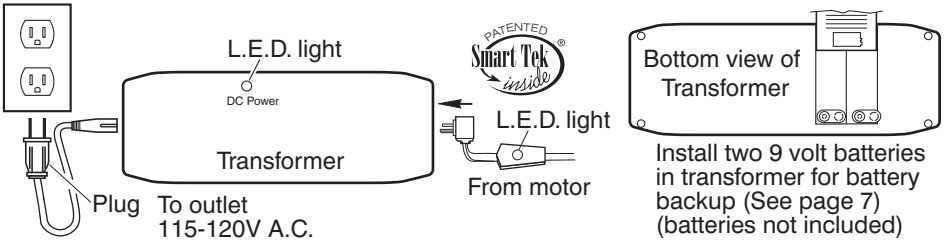

3. Place the chair in the desired position in the room, keeping it 25" away from the wall. If placing the chair into a corner, keep it 25" from the wall as shown. See distance chart below for your model.

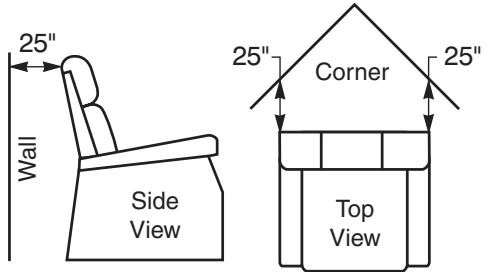

Distance Required From Wall When Reclined

Model Number	Wall	Corner
PR-756MC	25 in.	25 in.
PR-756L	27 in.	27 in.
PR-505JP	22 in.	22 in.
PR-505SM	23 in.	23 in.

Model Number	Wall	Corner
PR-505M	24 in.	24 in.
PR-505L	27 in.	27 in.
PR-516	27 in.	27 in.
PR-510	27 in.	27 in.

4. Adjust the leg levelers on the bottom of the chair if necessary to level the chair. Some high pile carpets can obstruct the footrest operation by rubbing against it. Raise the levelers to a height above the pile.
5. Slide the hand control from between the back and arm out toward the back of the chair. Secure the cord into the quick release cable clamp located above the magazine pocket on the arm of the chair.

AUTO DRIVE HAND CONTROL OPERATION

1. **To recline the back of the chair**, press button (S1) and hold until the back reaches the desired position. Then release the button.
2. **To bring the back of the chair to an upright position**, press button (S2) and hold until the back reaches the desired position. Then release the button.

3. **To raise the foot rest and seat**, press button (S3) and hold until the foot rest reaches the desired position. Then release the button.
4. **To lower the foot rest, seat, and lift the chair**, press button (S4) and hold until the footrest closes, then release the button. If you want to lift the chair, continue holding button until chair reaches the desired height. Then release the button.
5. **To lower the chair from a raised position**, press button (S3) and hold until the chair reaches the floor. Then release the button. If you want to raise the footrest, continue holding the button until the footrest reaches the desired position. Then release the button. From the lifted position you can also press buttons (S5, S6, S8 or S9) and the chair will move to those positions.
6. **To close and lift the chair from a reclined/seated position** (footrest up, back down), press button (S10). If you want to bring the chair to a seated position, hold the button until the footrest closes, then release it. Press button (S2) to bring the back the rest of the way up to seated position. If you want to close and lift the chair hold down (S10) until the chair stops. The motors will automatically shut off when the back closes and the chair reaches its highest position.
7. **Getting into your lift chair.** While standing next to your chair, press button (S10) and raise the chair to a height you can sit against. This height will vary from person to person depending on the individual's needs. Raise the chair high enough so you do not have to flop down into the chair. **Flopping down into the chair will damage it and could cause personal injury.** Press button (S3). As the chair continues downward adjust yourself into a position that is comfortable to you. Continue holding button until chair is in the seated position (chair firmly on the floor), then release the button. Continue operating the chair with buttons S1 thru S9 until you reach your desired position.
8. **Getting out of your chair.** Press button (S10) and raise the chair to a height that enables you to easily stand. Release the button. Return the chair to the seated position (chair firmly on the floor) after getting out of the chair so children, pets or obstructions do not get under the chair. Repeat no. 7 when you want to sit down.

Note: The motors are set to shut off when they reach their fully extended or fully retracted position if the selected button is not released. If you should go past your desired position, select the button to bring you back to your desired position. You can repeat the process as often as you like.

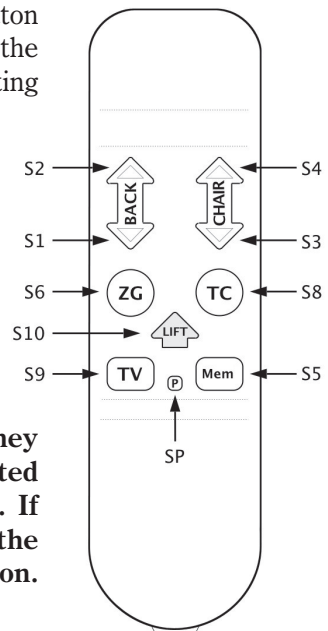

Programming the Memory Buttons S5, S9

Using buttons S1 thru S4 move the chair to a position that suits your needs. Use the following procedure to program the TV and Mem buttons.

1. Press and hold program (SP) button, the back light goes off while pressed
2. In about 3 seconds the backlight will start flashing (one flash)
3. Within 5 seconds, press one of the memory buttons (S5, S9) to save the position. The back light will return to non-flashing on when the position is stored.

If a programmable memory button is not pressed within 5 seconds, or a different button is pressed, then the programming sequence is aborted and you will need to repeat steps 1 to 3 above. You may reprogram the memory buttons as often as you like.

MAXICOMFORT™ POSITIONS

Your Golden power lift chair has been equipped with the MaxiComfort™ System. The MaxiComfort System has been designed specifically for you. Offering you a wide range of body positioning, so you can choose the position that best suits your needs. The MaxiComfort System accomplishes this by providing four primary motions: three recline, one lift and combinations of those motions, allowing you to settle into your favorite comfort position. Shown below are some of the Maxi Comfort positions. There are many to choose from. You may stop your Golden power lift chair at one of the positions shown or anywhere in between just by releasing the buttons on the hand control when the chair reaches the position you desire.

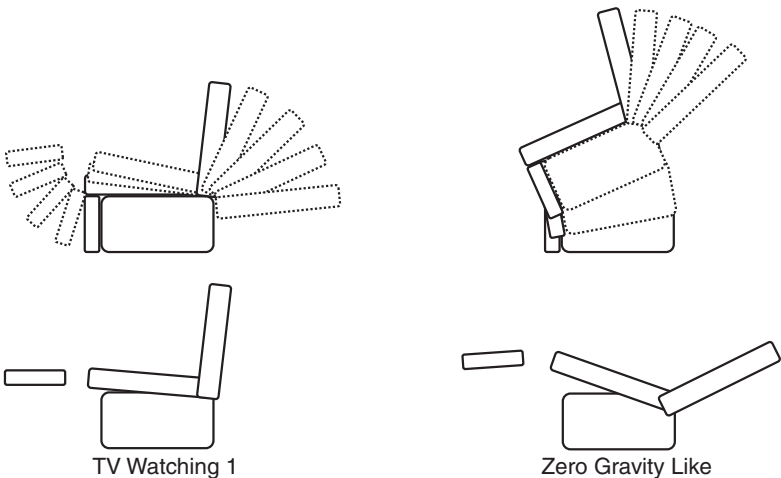

Drawings are for illustration purpose only

Battery Back Up System

Your Golden power lift chair comes with a battery back up system so the chair can return to the seated position in the event of a household power failure. The batteries have enough energy to bring the chair to a seated position from either recline or lift. The batteries do not have enough energy nor are they intended to operate the chair for a prolonged period of time in the absence of standard household voltage (120 volt, 60 Hz). Batteries should be replaced after one use. Batteries should be changed yearly. (See installation page 4.)

Smart Tek™ (Power Indication)

Regular servicing is not necessary on your Golden power lift chair. Your power lift chair is equipped with an indicator light on the hand control. This light illuminates green when any button on the hand control is pressed indicating power to the hand control.

Your power lift chair also comes with a power indicator light on the transformer and on the power cord connecting the motor to the transformer. The lights illuminate green constantly, indicating power from the outlet to the transformer and the motor. The lights have been provided to help you identify electrical disconnects, should they occur, and to help your dealer to diagnose electrical problems, should they occur.

Should the chair not operate and the lights are out, check all electrical connections to the chair. Make sure everything is plugged in properly and there is power to the outlet into which the chair is plugged (see installation on page 4 and 5 for electrical connections). Should you ever encounter a problem with the operation of your power lift chair and the lights are on, such as mechanical problems or one light is out, discontinue all use of the product upon discovery of the problem. Contact the dealer from whom you purchased your chair. They will be able to resolve problems and take care of proper factory service if needed. You will need to be prepared to answer some basic questions about your power lift chair, such as model and serial number. The model and serial number are located on the back of the hand control and the rear of the lift frame. Your dealer will ask you questions about your power indicator lights, such as which one is out. Prior to calling your dealer, check all the electrical connections to the chair. Make sure everything is plugged in properly and there is power to the outlet into which the chair is plugged (see installation on page 4 and 5 for electrical connections).



CONSUMER LIMITED LIFETIME AND SEVEN YEAR WARRANTY

MAXICOMFORT™ MODELS

GOLDEN, through its authorized distributor/service organization, warrants this chair to original consumer only, against defects in material or workmanship as follows:

LIFETIME WARRANTY

GOLDEN, warrants for the lifetime of the chair by the original consumer to repair or replace at their option the Lift Mechanism, Chair Frame and Recline Mechanism. Labor to replace these parts is subsidized on all models for three years.

GOLDEN, shall not be responsible or obligated to pay for any cost or expense for examination of any warranted parts nor is Golden to pay for costs for transportation, handling and packaging of the parts or components.

THREE YEAR PARTS WARRANTY

GOLDEN, warrants the electrical parts of this chair against defects to original consumer only, for a period of three years from the date of original purchase by a consumer. Labor to replace these parts is subsidized for one year on all models.

GOLDEN, shall not be responsible or obligated to pay for any costs or expenses for examination of any warranted parts nor is Golden to pay cost for transportation, handling and packaging of the parts or components.

LIMITED WARRANTY FOURTH THROUGH SEVENTH YEAR

During the period beginning with the expiration of the full three year parts warranty offered above and continuing through the seventh year after date of original purchase by a consumer, **GOLDEN** will warrant the electrical parts on the following pro-rated basis. Year 4 earns a 35% discount off suggested retail price. Year 5 earns a 25% discount, year 6 a 15% discount and year 7 a 5% discount. By way of example, a part costing \$100.00 that needs replacement in year 4 would cost \$65.00.

GOLDEN shall not be responsible or obligated to pay for any costs or expense for examination and/or service of any warranted part or to pay for costs of transportation, handling and packaging of the chair and/or parts or components.

TERMS APPLICABLE TO WARRANTY

GOLDEN will, at its option, repair and/or replace the defective parts and/or components provided that the warranty parts have not been subject to misuse, abuse or improper service by the consumer, have not been damaged in transit or handling and/or have not been altered or repaired by unauthorized representatives. This warranty does not include costs for unnecessary service calls, i. e., in-home service calls solely for the purpose of educating the consumer about the product, or finding an unsatisfactory power connection, etc. Exceeding the weight capacity of the chair will void the warranty.

756MC.....	375 lbs.	505 Medium	375 lbs.
756L	375 lbs.	505 Large.....	375 lbs.
505JP	300 lbs.	506	375 lbs.
505 Small.....	300 lbs.	510	375 lbs.

In the event that the product does not conform to this warranty at any time while this warranty is in effect, Golden will correct the defect in conformity with the Consumer Limited Lifetime and Seven Year Warranty. THE LIMITED LIFETIME AND SEVEN YEAR WARRANTY SET FORTH ABOVE IS THE SOLE AND ENTIRE WARRANTY PERTAINING TO THE PRODUCT AND IS IN LIEU OF AND EXCLUDES ALL OTHER WARRANTIES OF ANY NATURE WHATSOEVER, WHETHER EXPRESSED, IMPLIED, OR ARISING BY OPERATION OF LAW INCLUDING, BUT NOT LIMITED TO ANY IMPLIED WARRANTIES OF MERCHANTABILITY OR FITNESS FOR A PARTICULAR PURPOSE. THIS WARRANTY DOES NOT COVER OR PROVIDE FOR THE REIMBURSEMENT OR PAYMENT OF INCIDENTAL OR CONSEQUENTIAL DAMAGES.

Some states do not allow this exclusion or limitation of incidental damages so the above limitation or exclusion may not apply to you.

GOLDEN shall not be liable for any incidental or consequential damage or loss not contained in this Warranty.

This warranty gives you specific legal rights, and you may also have other rights, which may vary from state to state.

All warranty claims must be approved by Golden Technologies before any service is performed.

Warranty is valid in all 50 states, Canadian Provinces and Puerto Rico.

GOLDEN LIFETIME LIMITED WARRANTY

Register your GOLDEN POWER LIFT CHAIR by filling out this warranty card within 30 days of purchase date and returning to GOLDEN TECHNOLOGIES. Be sure to keep copies of this registration so you have all the information to refer back in case you experience a problem with your chair.

Name _____

Address _____

City _____ State _____ Zip _____

Purchase Date _____

Model No. & Size _____

Serial Number _____

Dealer's Name _____

Address _____

Why Did You Choose The Golden Power Lift Chair?

Appearance Price Dealer Reputation

Additional Comments _____

Remember to read your owner's manual carefully before you operate your chair. If you need help or additional information please contact your dealer.





PLACE
STAMP
HERE



GOLDEN TECHNOLOGIES
401 BRIDGE ST
OLD FORGE PA 18518-2323



Inquire about these fine mobility products also available from Golden Technologies



Try our full-time luxury scooter! Our Companion features our patented adjustable tiller, complete self-diagnostics, bright head/tail lights and a very comfortable seat with a weight capacity of 350 lbs!



Looking for a compact portable scooter? Our Buzzaround Lite is our smallest scooter offering a 250 lb. weight capacity. The Buzzaround Lite comes with three sets of shrouds in Red, Blue and Sahara.



The Golden Compass power chair is the ideal consumer power base. Featuring easy-to-use center wheel drive and many seating options, the Compass is in a class by itself!



Are you having trouble sleeping? Sleep better in the Golden luxury adjustable bed featuring multiple head and foot positioning with the option of a massage upgrade! No more tossing and turning in the Golden Luxury Adjustable Bed!
Not intended to be used as a medical device.

 **GOLDEN**
technologies
YOUR LIFE IN MOTION

FOR YOUR RECORDS

Please fill in your Power Lift & Recline Chair information below. This information will be useful in the event that you should ever need to contact Golden Technologies, Inc. concerning your lift chair.

Date of Purchase _____

Model _____

Serial Number _____

Your Golden Technologies, Inc. representative or dealer

Name _____

Company _____

Address _____



CAUTION



Do not allow children to play on this mechanized furniture or operate the mechanism.

Leg rest folds down on closing so that a child could possibly be injured.

Always leave chair in a sitting position. Keep hands and feet clear of mechanism. Only the occupant should operate it.



YOUR LIFE IN MOTION