

ROBOOTER

ROBOOTER E40

Instruction Manual



Shanghai Bangbang Robotics Co., LTD.

CONTENTS

Dear users,

We sincerely appreciate your choice of the Electric Wheelchair from Shanghai Bangbang Robotics Co., LTD. The Robooter E40 Product Manual serves as a vital document, offering comprehensive product information, operational guidelines, and after-sales service details for the Electric Wheelchair. Before use, we strongly advise you to meticulously review the Robooter E40 Product Manual to ensure proper operation and maintenance. Please be aware that this manual contains information protected by patent rights and copyright. Reproduction, whether in part or in full, is strictly prohibited without the written permission of Shanghai Bangbang Robotics Co., LTD. Kindly note that the contents of this manual may undergo modifications without prior notice. To access the most up-to-date information about the equipment, please visit the Robooter website.

Thank you for your trust and choosing Robooter.

Sincerely, [Your Name] Customer Support Team Shanghai Bangbang Robotics Co., LTD



CONTENTS INCLUDE



1.Safety Precautions



2.Product Introduction



3.Part introduction
of the Electric Wheelchair



4.Use of the
Electric Wheelchair



5.Maintenance and
Troubleshooting



6.APP Electric Wheelchair
APP Operation Guide



7. Cybersecurity



8. Wireless technology
and Funtions



9.Disclaimer



10.Packing list



11.Reprot serious event
to FDA



12.Marking Description

1.1 Symbol description

Warning

- The text accompanied by this symbol indicates that ignoring it could result in serious injury.

Attention

- Injury may occur if the information associated with this symbol is ignored.

1.2 Expected Population

- Adult only.

1.3 Indication for Use

- **Contraindications:** Patients with mental problems, including users who temporarily or permanently lose attention or judgment, are not allowed to use this product.

1.4 People unsuitable for using this product

Warning

- **Contraindications:** The patients with mental problems, including the users who temporarily or permanently lose attention or judgment, are not allowed to use this product.



Warning

- Keep this medical device 6 inches (15 cm) away from magnetically susceptible medical devices such as cochlear implants, neurostimulators, stents and shunts.

1.5 Precautions for electrical safety



Attention

This Electric Wheelchair has passed the test in accordance with ISO 7176-9 Climatic Test.

- This test ensures that the users or escorts of the Electric Wheelchair have enough time to move the Electric Wheelchair from the rain to a safe place;
Do not operate the Electric Wheelchair in thunderstorms;
- Do not place this Electric Wheelchair under a rainstorm;
- Do not place this Electric Wheelchair in a wet place for a long time;
- Do not spray or wash the Electric Wheelchair with an automatic car wash. If
- being directly exposed to rain, smog or wet air, the Electric Wheelchair may have an electrical and mechanical fault or go rusty.

1.6 Product use conditions



Attention

- Environmental temperature: -10°C~50°C; Relative humidity: 20%~95%;
- Atmospheric pressure: 70kpa~110kpa; No strong electromagnetic interference.
- The safety belt is used as a safety accessory; it is used to prevent the user from rushing out of the Electric Wheelchair when it stops in operation to ensure the safety of the user.

1.7 Disposal considerations



Attention

- In accordance with local laws and regulations, your product shall be processed separating from the domestic waste. The product shall be recycled in the recycling point designated by local government. The classified collection and recycling of this product facilitate conservation of natural resources.

1.8 Warnings the use of electric wheelchairs

(1) Driving on slopes

- This Electric Wheelchair has passed the test requirements of climbing on a slope of not exceeding 9° with a load of 150kg. Do not try to climb the slopes exceeding 9°. During reversing on a slope, please be sure to slow down the Electric Wheelchair. Do not reverse on a slope exceeding 9°. During reversing, please be extremely careful.

(2) The ability of climbing slope and driving distance are affected by battery and following environment:

- For example: Weight of the users; Topography (such as grass or gravel); Gradient of hill; Battery life and service life; Extreme temperature; Use and weight of the fittings, etc.

(3) Braking

- When the Electric Wheelchair brakes, please sit down and hold the handrail firmly. When releasing the upper controller rocker, the Electric Wheelchair will stop within seconds.
- Note: Electromagnetic brake will not take effect immediately and will take effect after the wheel rotates.

(4) Emergency braking

- In case of critical situation or unexpected movement, press the power switch key to make the Electric Wheelchair stop (this emergency brake is effective, however, it shall not be used under normal conditions).
- Note: Frequent use of emergency brake may make the motor faulty and further prevents the Electric Wheelchair from being normally used.

(5) Use of mobile phone

- Do not drive the wheelchair with Mobile Application at any time. Please pay attention to road condition when you driving. The Mobile Application only can be used to help patient move wheelchair and set parameters, NOT used to drive wheelchair.

(6) Limitations on use

- The Electric Wheelchair may not be fixed as a seat in a moving vehicle;
- Any changes or modifications not expressly approved by the party responsible for compliance could void the user's authority to operate this equipment;
- Do not drive the device on soft surfaces such as gravel, grass, sand, mud, snow, or on frozen paths;
- Please follow the traffic rules;
- Do not perform snake driving, high-speed sharp turn and other dangerous driving operations, otherwise it may lead to the Electric Wheelchair tilt and human injury;
- The Electric Wheelchair may not be fixed as a seat in a moving vehicle;
- Any changes or modifications not expressly approved by the party responsible for compliance could void the user's authority to operate this equipment;
- Do not drive the device on soft surfaces such as gravel, grass, sand, mud, snow, or on frozen paths;
- Please follow the traffic rules;
- Do not perform snake driving, high-speed sharp turn and other dangerous driving operations, otherwise it may lead to the Electric Wheelchair tilt and human injury;
- Do not use the Electric Wheelchair on escalators, which may increase the risk of being injured;
- Do not drive on the motor vehicle lane or non-pedestrian;
- Do not drive on the surface of water, oil, ice or other slippery objects. If not, the Electric Wheelchair may be out of control;
- Do not try to cross the obstacle or ditch of 40mm. If not, personal injury may be caused;
- Do not sharply bend or move backwards under high speed driving;
- Do not take passengers on the Electric Wheelchair;
- Please always pay attention to the surrounding environment;
- Without the permit of the manufacturer, the equipment shall not be modified;
- Any changes or modifications could potentially lead to a degradation in device performance or harm to users;

- Do not get on without braking;
- Do not operate the Electric Wheelchair when your judgment may be affected (such as drink, take drugs or take medicine);
- Do not operate the Electric Wheelchair when you are suddenly out of sorts;
- Do not operate the Electric Wheelchair when your sight is seriously weakened;
- For the injury accident caused by violation of local or international laws or regulations, we undertake no responsibility;
- All the functions can only be operated after you correctly sit on the seat;
- Do not place your feet in any part out of the pedal;
- Do not stand on the Electric Wheelchair;
- Do not try to go up and down the slope exceeding 9°;
- Do not reverse on the slope exceeding 9°;
- Do not operate the Electric Wheelchair without checking the fasteners, connectors or detachable parts for correct connection and fastening.
- Do not try to pick up objects by bending down when sitting on the Electric wheelchair. Doing so could result in the electric wheelchair or user rolling over, and potential damage to the wheelchair.
- Do not pull another electric wheelchair.
- Do not connect other medical equipment (such as life support equipment and respirator, etc.) to the electronic system of the Electric wheelchair.

(7)others

- The speed of the whole vehicle will vary depending on the tire pressure, ground, environment and power;
- Tyre inflation pressure range: 220kpa-240kpa;
- When driving on the slope, release the control system, and the Electric Wheelchair may step back; When moving forward or backward, the Electric Wheelchair may roll before the braking function takes effect. Please take care of safety.

1.9 Excerpts from EMC-related guidelines and statements in manufacturer's accompanying documents

EMI Compliance Table(Table 1)

Phenomenon	Compliance	Electromagnetic environment
RF emissions	CISPR 11 Group 1,Class B	Home healthcare environment
Harmonic distortion	IEC61000-3-2 Class A	Home healthcare environment
Voltage fluctuations and flicker	IEC61000-3-3 Compliance	Home healthcare environment

Table 1-Emission

EMS Compliance Table (Table2-5)

Phenomenon	Basic EMC standard	Immunity test levels
		Home healthcare environment
Electrostatic Discharge	IEC 61000-4-2	±8kV contact ±2kV, ±4kV, ±8kV, ±15kV air
Radiated RF EM field	IEC 61000-4-3	20V/m 26MHz-2.5GHz 80% AM at 1kHz 10V/m 80MHz-2.7GHz 80% AM at 1kHz
Proximity fields From RD Wireless communications equipment	IEC 61000-4-3	Refer to table 3
Rated power Frequency Magnetic fields	IEC 61000-4-8	30A/m 50Hz or 60Hz

Table 2-Enclosure Port

Test Frequency (MHz)	Band (MHz)	Immunity test levels
		Home healthcare environment
385	380-390	Pulse modulation 18Hz, 27V/m
450	430-470	FM, ± 5 kHz deviation 18Hz sine, 28V/m
710	704-787	Pulse modulation 217 Hz sine, 28V/m
745	800-960	Pulse modulation 18Hz sine, 28V/m
780		
810		
870		
930		
1720	1700-1990	Pulse modulation 217Hz sine, 28V/m
1845		
1970		
5785		

Table 3 – Proximity fields from RF wireless communications equipment

	Standard	Home healthcare environment
Electrical fast Transients/burst	IEC 61000-4-4	± 2 KV 100kHz repetition frequency
Surges Line-to-line	IEC 61000-4-5	± 0.5 kV, ± 1 kV
Conducted Disturbances Induced by RF fields	IEC 61000-4-6	3V, 0.15MHz-80MHz 6V in ISM bands and amateur radio bands Between 0.15MHz and 80MHz 80%AM at 1kHz
Voltage dips	IEC 61000-4-11	0% U_i ; 0.5 cycle At $0^\circ, 45^\circ, 90^\circ, 135^\circ, 180^\circ, 225^\circ, 270^\circ$ and 315°
		0% U_i ; 1 cycle and 70% U_i ; 25/30 cycles Single phase: at 0°
Voltage interruptions	IEC 61000-4-11	0% U_i ; 25/30 cycles U_i = rated input Voltage

Table 4 – Input a.c. power port

Phenomenon	Basic EMCstandard	Immunity test levels
		Home healthcare environment
Conducted disturbances induced by RF fields	IEC61000-4-6	3V.0.15MHz-80MHz6V in ISM bands and amateur radiobands between 0.15MHz and 80MHz 80%AM at 1kHz

Table 5 – Signal input/output parts port

Cable	Max. cable length, Shielded/unshielded		Number	Cable classification
	Shielded	Unshielded		
AC Power Line	1.8M	Unshielded	1 Set	AC Power
DC Power Line(USB Cable)	0.95M	Unshielded	1 Set	DC Power

Table 6-Cable information

2.1 Product features and functions

The DC brushless deceleration motor is the core part to drive the Electric Wheelchair.

- The special upper controller is used to achieve the control of the motor.

Through the independent rocker operation, it can achieve forwarding, differential turn, low speed reversing and other actions;

- folding and unfolding action can be realized;
- Automatic shutdown if case of no 30min operation. The app terminal can select the automatic shutdown time: 30min, no shutdown;
- Cruise control mode: Press "speed ^" button for 3 seconds and enter the cruise control mode. The front rocker starts the cruise control;
- Novice mode: Click Fn to enter the novice mode. The voice prompts "Enter the novice mode" and the screen displays the novice mode icon. The first and second gears are optional. Speed gear limit 2.

2.2 Main structure of the product



Figure 2.2.1

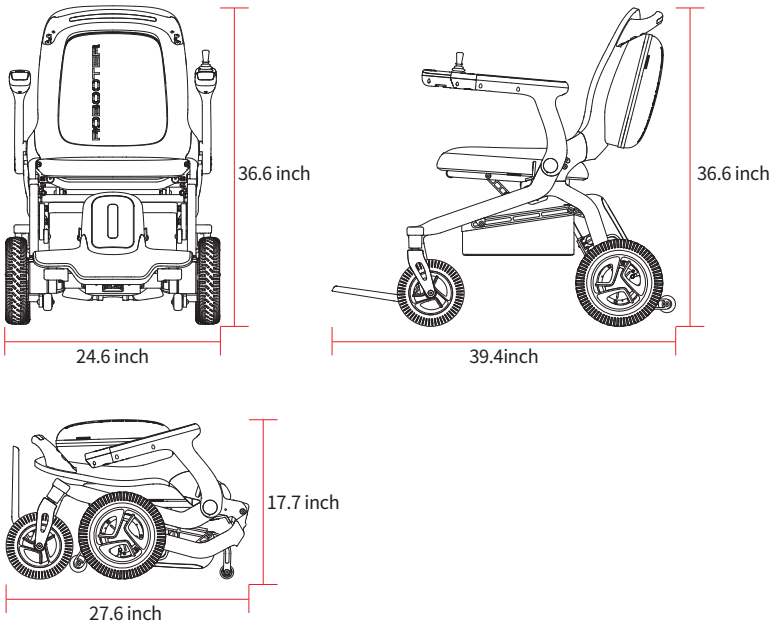

Figure 2.2.2

2.3 Main technical indicators

Common name	Powered wheelchair
Product model	BBR- E40-01
the type class of the wheelchair: Class A, Class B or Class C	Class A
Overall length with largest	1000mm
Overall width	624mm
Folded length	700mm
Folded width	624mm
Folded height	450mm
Total mass	27kg
Mass of the heaviest part	23.5kg
Static stability downhill	9°
Static stability uphill	9°
Static stability sideways	9°
Energy consumption	21.5km
Dynamic stability uphill	9°
Obstacle climbing	40mm
Maximum speed forward	8km/h
Minimum braking distance from max speed	1020mm
Seat plane angle	3°
Effective seat depth	430mm
Effective seat width	420mm
Seat surface height at front edge	500mm
Backrest angle	16°
Backrest height	460mm
Footrest to seat distance	440mm
Leg to seat surface angle	100°
Armrest to seat distance	220mm
Front location of armrest structure	515mm
Handrim diameter	N/A
Horizontal location of axle	103mm
Minimum turning radius	450mm
Maximum occupant mass	150kg

Table 2.3

The wheelchair conforms to the following standards:

a) requirements and test methods for static, impact and fatigue strengths (ISO 7176-8).

Yes

b)power and control systems for electric wheelchairs - requirements and test methods (SO 7176-14).

Yes

c)climatic test in accordance with ISO 7176-9.

Yes

d)requirements for resistance to ignition in accordance with ISO 7176-16.

Yes

The items in this annex which apply are only those that are relevant to the specific wheelchair being disclosed. For example, parts of the table apply only to powered wheelchairs and therefore would not apply to manual wheelchairs.

2.4 Storage conditions

- The packaging storage temperature is $-20^{\circ}\text{C}\sim 60^{\circ}\text{C}$;
- The relative humidity is no more than 95%;
- The atmospheric pressure shall be $56\sim 110\text{kPa}$;
- The Electric Wheelchair shall be stored in the ventilated room without the harmful gas which may cause corrosion, and it is not allowed to press and pile up;
- Under packed status, the maximum piling height is 5 layers.
- Do not make the product stored in the places which get close to high temperature source or direct sunlight for a long term.
- If the product will not be used for a long term, please store the Electric Wheelchair is fully charged and power off.
- If the product is stored exceeding one month, please fully charge, and then continue storing and using.



Figure 3.1

4.1 Notice for use

- Please carefully read the Safety section before use and properly use the product as guided by the Manual;
- The safety reminders help use the product safely and properly. In order to differentiate various degrees of harm and damage, the possible damage brought by misuse is categorized into “warning” and “caution”. The two are both critical reminders on safety and require strict compliance;
- Please carefully read the Product Manual before use and check whether the parts are in good condition to ensure your safety;
- When the Electric Wheelchair is operated for the first time, level and hard ground shall be selected as soon as possible to ensure that your sounding area has no barrier or pedestrian;
- Do not remove the motor and the upper controller by yourself. If replacement is required, please purchase the original parts from the authorized agent;
- If the Electric Wheelchair is artificially modified, the use of non-original parts will be exempted from the warranty liability;
- Do not give the Electric Wheelchair to minors or other people who are not suitable for the Electric Wheelchair;
- Do not overload driving (the maximum load of the Electric Wheelchair is 150Kg); It is limited for 1 person;
- Make sure that the Electric Wheelchair is already fully expanded;
- Make sure that you have fastened the Electric Wheelchair seat belt;
- When you sit correctly in the Electric Wheelchair and gently push the upper controller rocker, the Electric Wheelchair will move forward, back, turn left or turn right; The Electric Wheelchair will be stopped after the release. Practice this basic function until you are skilled;
- During steering, please clear the barriers nearby;
- Please obey the traffic rules and drive in the non-motorized lane to ensure the safety of you and others. Please drive slowly and Do not take others;
- When the Electric Wheelchair is operated in a relatively harsh environment (e.g., when entering or turning), the Electric Wheelchair should be operated slowly. It is recommended to minimize to the lowest speed of the Electric Wheelchair in harsh environments;
- Check whether the Electric Wheelchair is in good condition, such as whether the performance is normal;
- The Electric Wheelchair will automatically shut down if being idled for 30 minutes;

- When using an Electric Wheelchair, avoid being close to a radio transmitter, high-power handheld radio transmitter or receiver;
- Any error or improvement in the Product Manual will be specified in the new specification. We may launch new products to meet the market needs at any time. If there is any difference between the relevant functional description and performance and this manual, the specific products and relevant supplementary instructions shall prevail, and it will not be stated in this manual.

4.2 Expanding and folding of the Electric Wheelchair

4.2.1 Expanding and folding operation mode

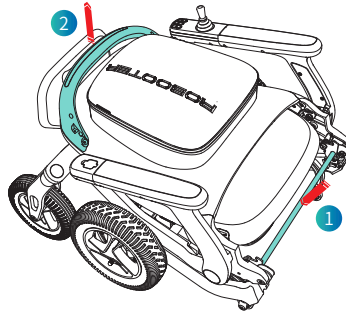

Figure 4.2.1.1

Expanding operation mode: When manually expanding the Electric Wheelchair, please press the folding switch with one hand (position 1 in Figure 4.2.1.1) and pull the armrest up with the other hand (position 2 in Figure 4.2.1.1) until the Electric Wheelchair is fully expanded;

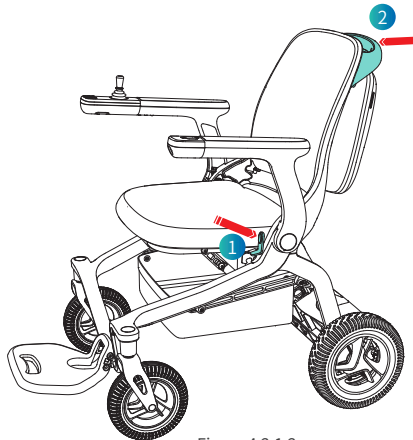

Figure 4.2.1.2

Folding operation mode: When manually folding the Electric Wheelchair, please press the folding switch with one hand (position 1 in Figure 4.2.1.2) and pull the armrest up with the other hand (position 2 in Figure 4.2.1.2) until the Electric Wheelchair is fully folded;

Remarks: Before folding the Electric Wheelchair, empty the items in the storage basket to prevent damage.

4.2.2 Anti-clamp

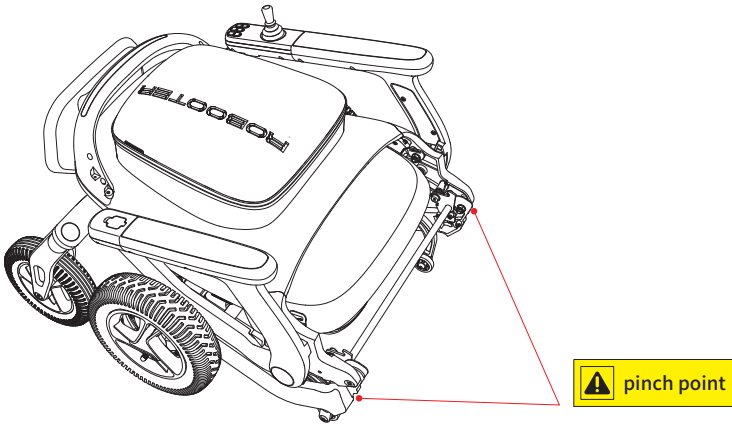

Figure 4.2.2

Note: During the folding/expanding steps, Do not contact the position indicated in the anti-clamp manual;

4.3 Upper controller

4.3.1 Introduction to the upper controller

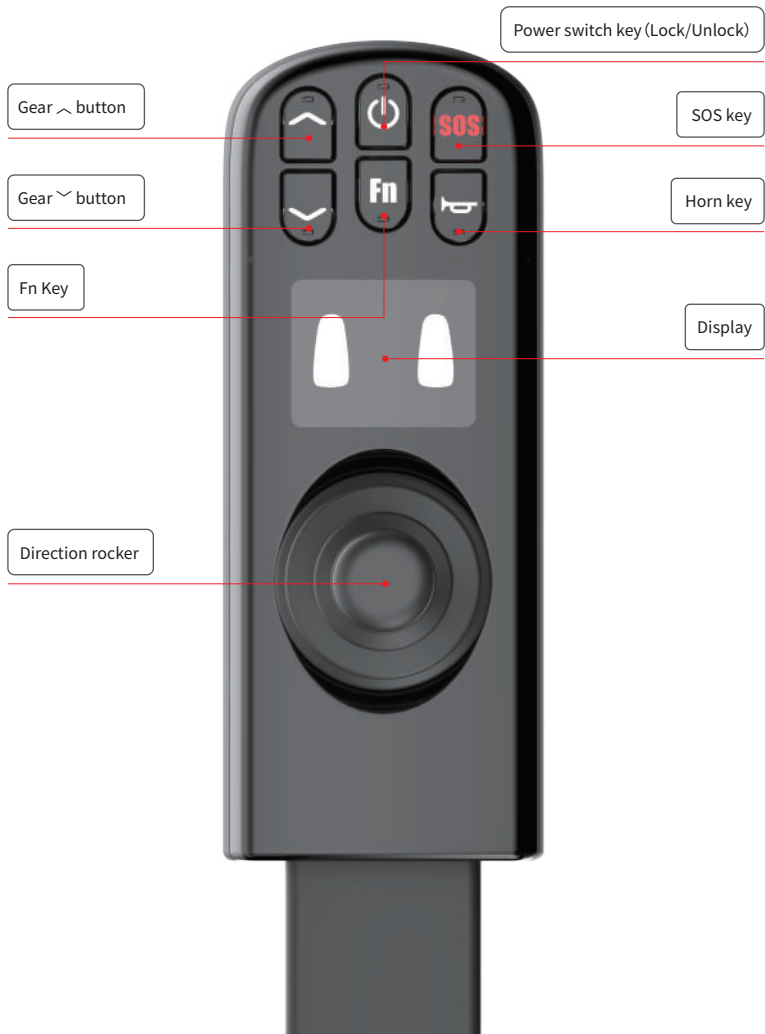

Figure 4.3.1

4.3.2 Function description of the upper controller

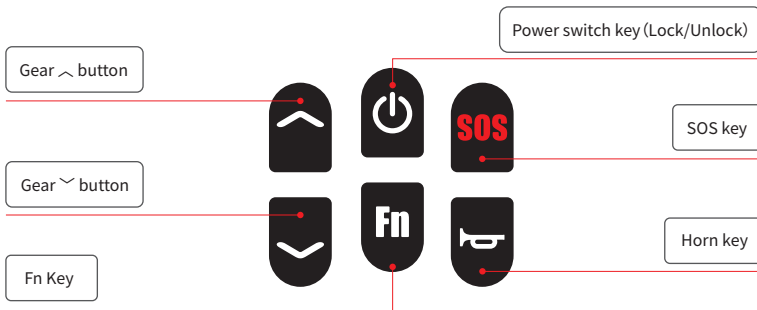

Figure 4.3.2

(1) Direction rocker

Pushing the upper controller rocker can control the speed and direction of the Electric Wheelchair;

(2) Power switch key

Long press for 3 seconds to turn on the power supply and long press for 3 seconds to turn off the power supply;

Press the power switch key to turn on the vehicle locking function;

Press the power switch key to unlock the entire vehicle, and the current status is unlocked;

(3) Gear ^ button

Press " ^ " to add a gear (Up to 5 gears);

(4) Gear v button

Press " v " to reduce one gear (minimum 1 gear);

(5) Horn key

Press the horn button once, and the horn will sound once;

(6) SOS key

Press and hold for 3 seconds to sound the SOS alarm of the Electric Wheelchair;

(7) Fn key

Click Fn to enter the novice mode, and the screen will display gear 1, gear 2 and the NOVICE icon, accompanied by the voice prompt of "Enter the novice mode". Speed gear limit 2 (the first and second gears are optional).

Long press the Fn key for 5s to enter the General mode, and again long press the Fn key for 5s to exit the General mode; (General speed mode: the speed of each gear is 75% of the speed in the Enhanced gear); App adjustments are detailed in the APP operating instructions.

4.3.3 Display screen menu description

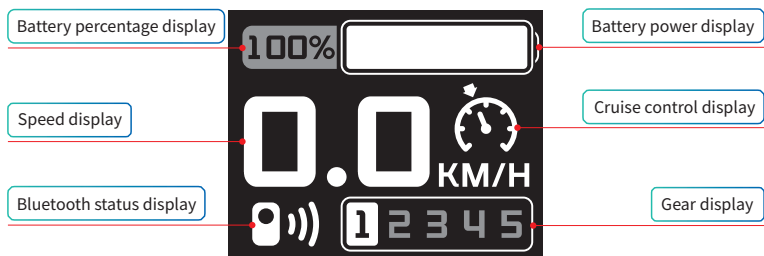

Figure 4.3.3.1

(1) Battery percentage display (as shown in Figure 4.3.3.1)

The upper controller screen of Electric Wheelchair displays the battery in %;

(2) Speed display (as shown in Figure 4.3.3.1)

The upper controller screen displays the Electric Wheelchair driving speed (unit: km/h);

The precision of the displayed speed is $\pm 5\%$;

(3) Bluetooth status display (as shown in Figure 4.3.3.1)

Without Bluetooth connection, the Bluetooth indicator sign is not displayed on the screen;

With Bluetooth connection, the Bluetooth indicator sign is displayed on the screen;

(4) Battery power display (as shown in Figure 4.3.3.1)

The upper controller displays the power state in real time;

(5) Cruise control display (as shown in Figure 4.3.3.1)

- Press and hold the "Speed \wedge " button for more than 3s to enter the cruise control mode. The Electric Wheelchair upper controller screen displays the cruise control icon, and the voice prompts two times. Push the rocker forward to start the cruise control;

- Press the lock key or move the rocker backward to exit the cruise control (regardless of driving state);

- The cruise control function can only be triggered when non-locked, and cannot be triggered in locked mode;

- "∧" and "∩" can be used to adjust the gears during the cruise control process;
- Dial the rocker to control the bending during the cruise control process;
- After entering the cruise control mode, if the cruise control mode is not started within 5s, the cruise control mode will be automatically exited, and the voice prompt "With wait timeout, the cruise control mode has been automatically exited" will be given.

(6) Gear display (as shown in Figure 4.3.3.1)

Press "∧" to add a gear (Up to 5 gears)

Press "∩" to reduce one gear (minimum 1 gear);

The above functions can also be realized on the APP (the App can be adjusted in different gears);

The Electric Wheelchair upper controller screen displays the speed gear.

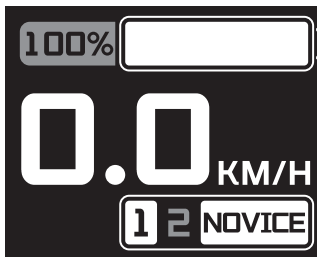

Figure 4.3.3.2

(7) Novice mode display (as shown in Figure 4.3.3.2)

Click Fn to enter the novice mode, and the screen will display gear 1, gear 2 and the NOVICE icon, accompanied by the voice prompt of "Enter the novice mode". Speed gear limit 2 (the first and second gears are optional).



Figure 4.3.3.3

(8) Fault code display (as shown in Figure 4.3.3.3)

For the diagnostic code displayed by the built-in information diagnostor of the product, refer to 5.2 troubleshooting for the content.



Figure 4.3.3.4

(9) SOS display (as shown in Figure 4.3.3.4)

Long press SOS button for 3 seconds to start SOS call. The screen displays SOS icon and flashes.

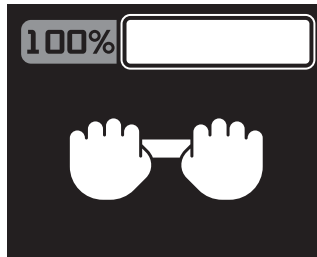

Figure 4.3.3.5

(10) Pushing mode display (as shown in Figure 4.3.3.5)

At the same time, press and hold the button "Speed \wedge " and "Speed \vee " for 3s, and the pushing mode icon will be displayed on the upper controller screen of Electric Wheelchair.

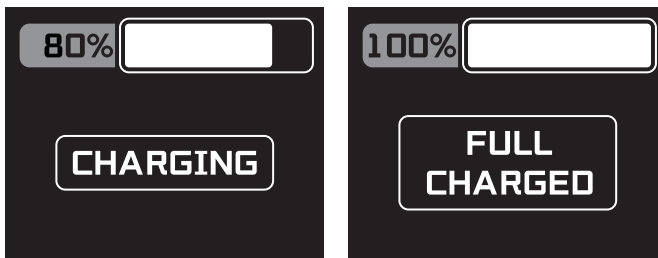

Figure 4.3.3.6

(11) Battery charging status display (as shown in Figure 4.3.3.6)

After the charging port of the Electric Wheelchair is connected to the charger, the upper controller screen will display CHARGING icon, meaning that the Electric Wheelchair is being charged;

After the Electric Wheelchair is fully charged, the upper controller screen will display FULL CHARGED icon, meaning that the Electric Wheelchair has been charged.

4.4 Usage of armrest touch light and USB charging port

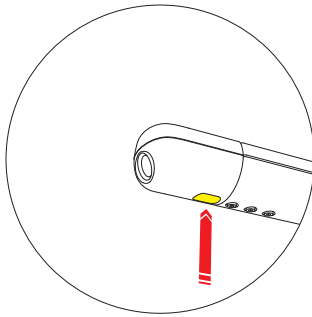

Figure 4.4.1

Touch the touch switch of the lower armrest lamp on the left upper control to control the light on and off of the armrest touch lamp. (As shown on Figure 4.4.1)

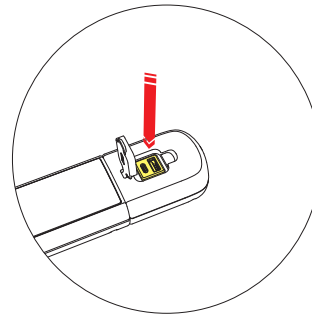

Figure 4.4.2

The armrest touch lamp assembly provides two USB charging ports(USB Type-A, USB Type-C). (As shown on Figure 4.4.2)

Purpose of USB port: To charge user's phone or other device.

Types: Type-A, Type-C

Standard: USB 2.0(Type-A), USB 3.0(Type-C)

Anticipated user: User of this wheelchair

The connection is not meant to control the operations of another device

Specifications:

Operating Temperature Range: -40°C~+85°C

Power supply protocol: DP=2.0V, DM=2.7V Output 2A(MAX)

Contact material: copper alloy

Contact plating: gold List of the data attributes being exchanged: NA

Caution:

Do not allow unknown devices to be plugged in to prevent the spread of malware.

These USB ports are only used for charging mobile phones and other devices, and it is prohibited to transmit any data.

4.5 Left and right handrails

4.5.1 Interchangeable operation mode of left and right armrest controllers

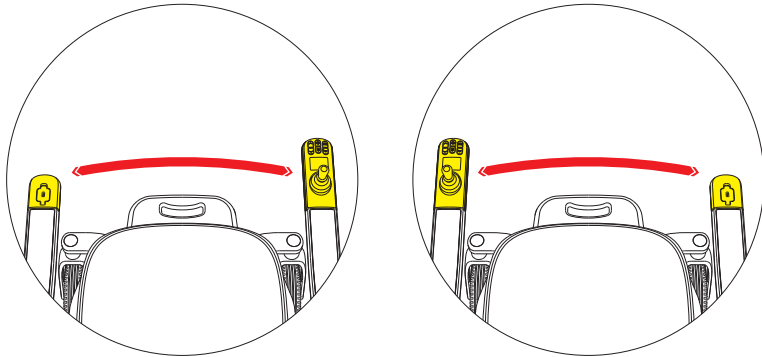

Figure 4.5.1

Step 1, please turn off the machine power before exchanging the left and right armrest controllers.

Step 2, use a hex wrench to remove the three Allen screws under the armrest controller and open the connecting harness of the left and right controllers.

Step 3, interchange the left and right controllers, connect the harness, insert the left and right controllers into the armrest controller card slot, and use the hexagon wrench to lock the hexagon socket screws. (As shown on Figure 4.5.1)

4.5.2 Gear adjustment operation mode of left and right armrest controller

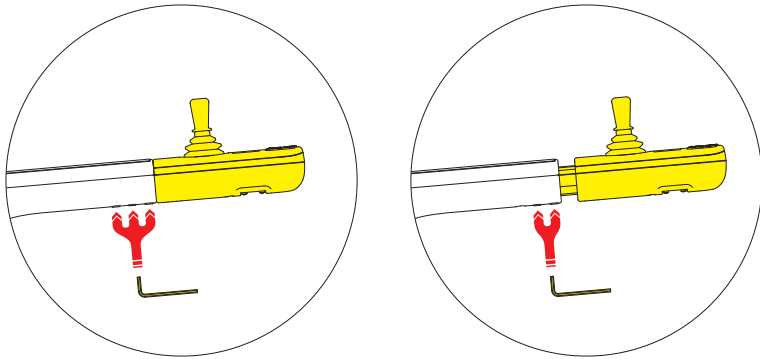

Figure 4.5.2

Step 1, please turn off the machine power before adjusting the gear of the left and right armrest controllers.

Step 2, use a hex wrench to remove the three Allen screws under the armrest controller, and the controller moves outward by one gear.

Step 3, use the hexagon wrench to lock the hexagon socket screw. (As shown on Figure 4.5.2)

4.6 Battery & battery charger

Charge the battery before using for the first time. Ensure the battery is charged before use if the device has not been used for a long period of time. The maximum driving range of this device (13.4 miles (21.5 km)) was measured under ideal conditions; however, the actual range may vary depending on the driving conditions such as hills, curves, steps, terrain, driving habits, load, and temperature. If the device is going to be driven for an extended period of time or a longer distance, we recommend the following suggestions:

- Fully charge the battery before use.
- Keep weight of storage items to a minimum.
- Plan your route to avoid hills and obstacles.
- Maintain consistent speed and avoid sudden and frequent stops.



Warning

- **Carefully read the explanations in this manual regarding the battery and charger, and follow the instructions.**

There is a risk of fire or battery explosion when disassembling the battery or charger. Do not allow flames near the battery or charger, avoid getting the battery and charger wet or subjecting them to impact (dropping, penetration with nails, or standing on them), etc.

- **Device battery should be charged in a well-ventilated space that is free of flammable gases and that is at least twice the size of the device.**

There is a risk of explosion or other accidents if the space is filled with flammable gas or if ventilation is insufficient.

- **If the battery has external damage or you notice an abnormality in its functioning, immediately discontinue use or charging, and contact your dealer.**

There is a risk of electric shock, short circuit, and fire.

**Attention**

- If the device is not used for a long period, ensure the battery is fully charged before storing. Charge the battery at least once a month.
- There is a risk that the battery may get excessively depleted and cannot be charged.
- There is a risk of a short circuit caused by foreign objects.

4.6 Battery & battery charger**4.6.1 User manual for battery****4.6.1.1 Cycle life**

After 1000 charge and discharge cycles, Capacity $\geq 70\%C_i$

C_i : the first discharge capacity of cycle life test at $25 \pm 2^\circ\text{C}$

4.6.1.2 Battery disassembly

Figure 4.6.1.1

(1) In Step 1, manually rotate the left knob of the battery case and rotate the left knob to the unlocking position. Then open the battery left buckle. (As shown on Figure 4.6.1.1)

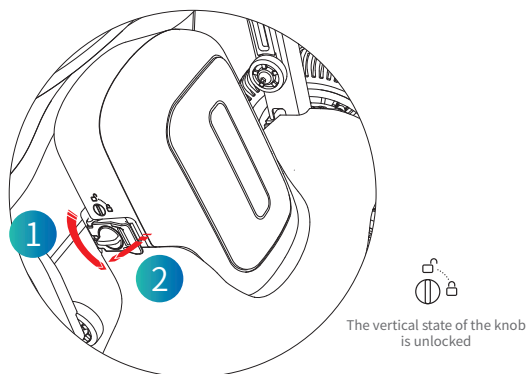
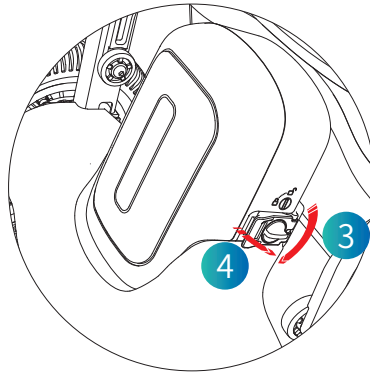

Figure 4.6.1.2

(2) In Step 2, manually rotate the right knob of the battery case and rotate the right knob to the unlocking position. Then open the battery right buckle. (As shown on Figure 4.6.1.2)

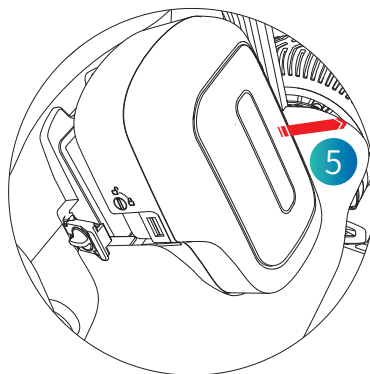

Figure 4.6.1.3

(3) In Step 3, remove the battery in the direction shown in the figure. (As shown on Figure 4.6.1.3)

4.6.1.2 Battery Installation

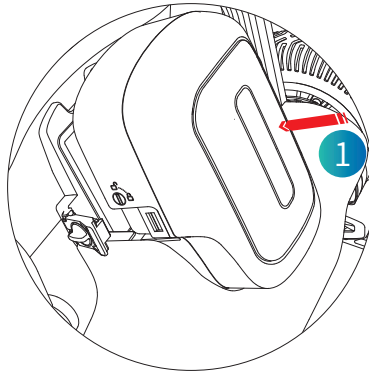

Figure 4.6.2.1

(1) In Step 1, place the battery in the cell slot in the direction shown. (As shown on Figure 4.6.2.1)

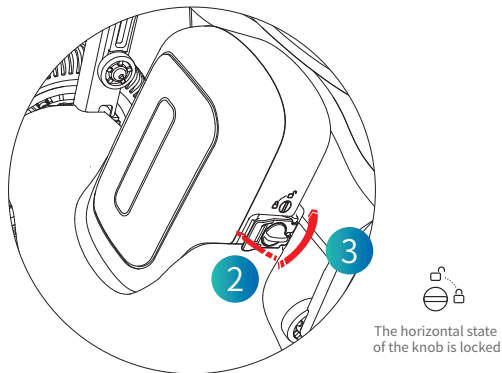

Figure 4.6.2.2

(2) In Step 2, manually close the battery right buckle and rotate the right knob of the battery box with the right knob to the locked position. (As shown on Figure 4.6.2.2)

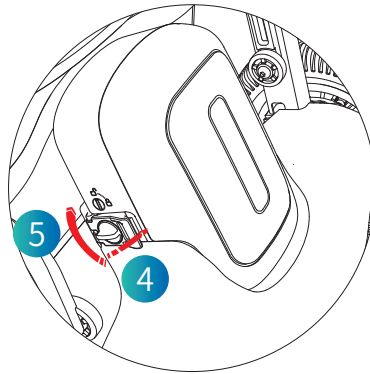

Figure 4.6.2.3

(3) In Step 3, manually close the battery left buckle and rotate the left knob of the battery box with the left knob to the locked position. (As shown on Figure 4.6.2.3)

4.6.2 User manual for battery charger:



Attention

- Users should read the instructions before attempting to use the battery charger.
- The battery charger is intended for indoor use and is not to be exposed to rain or other sources of moisture (unless the environmental protection rating of the battery charger is at least IPX4).
- Explosive gasses can be generated while charging, so the wheelchair and battery charger are to be kept away from sources of ignition, such as flames and sparks.
- Charging is carried out with the wheelchair in a space at least twice its volume, with sufficient ventilation that there is no hazard due to build-up of flammable gas.
- Only batteries of the specified type and capacity are to be charged.
- Off-board battery chargers are not to be carried on wheelchairs.
- Do not charge the battery while the brakes are released. There is a risk that the device may move, causing an accident.

- Do not use the charger and AC connector cord other than those provided with the device. Using a charger or AC connector cord other than the one supplied may result in electric shock, or in burns caused by charger overheating. In addition, do not use the charger and AC connector cord included with the device in any other device.

4.6.2.1 Basic information

Model	YS90-2943000
Rated output current	3A
Rated output voltage	24V
Operating Temperature Range	-40C to 80°C
Battery charger environmental protection class	class VI
Battery Model	LY-BT-09
Battery Rated Capacity	20AH

Table 4.6.2.1.1

4.6.2.2 Charger indicator displays

- The charger indicator illuminates or flashes according to the battery states as shown below:
 - Red Light means charging.
 - Green light means full charger or disconnect.

4.6.2.3

- The device cannot be used while the battery is being charged.
- The approximate charging time is 8 hours.
- The charger is designed to prevent overcharging. Even if the charger is left plugged in for more than 8 hours, there is no risk of the device being damaged. However for safety reasons, avoid leaving the charger plugged into the wall outlet for a long time.
- Immediately disconnect the DC connector from the battery after charging is completed.
- If the usable time after charging has become abnormally short and the battery must be replaced, contact your distributor or customer sup

4.7 Switch to pushing mode

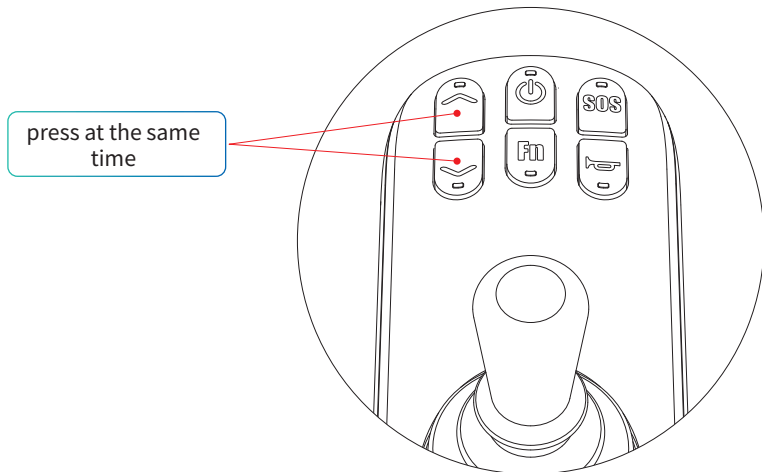

Figure 4.7

Press '↑' key and '↓' key at the same time to enter pushing mode. Shake the rocker can exit the pushing mode;(As shown on Figure 4.7)

4.8 Electric Wheelchair charging mode

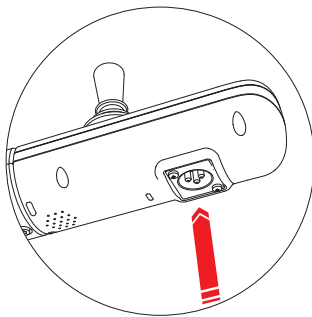

Figure 4.8.1

Charging method I: Connect the charger and plug the charger plug into the upper controller for charging;(As shown on Figure 4.8.1)

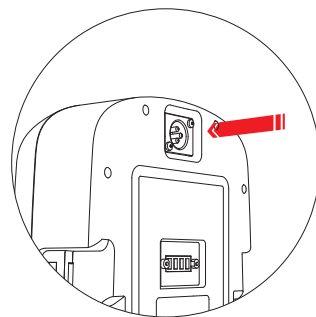

Figure 4.8.2

Charging method II: Take out the battery, plug the charger plug into the charging port of the battery to charge;(As shown on Figure 4.8.2)

4.9 Getting in the device

Accessing the seat from the side

- (1) Ensure that the power is turned off.

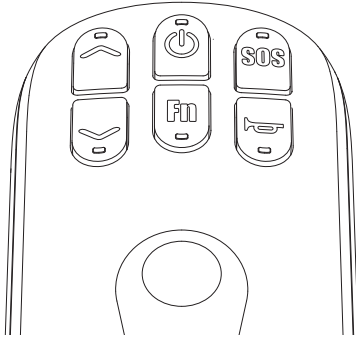

- (2) Raise the arm.

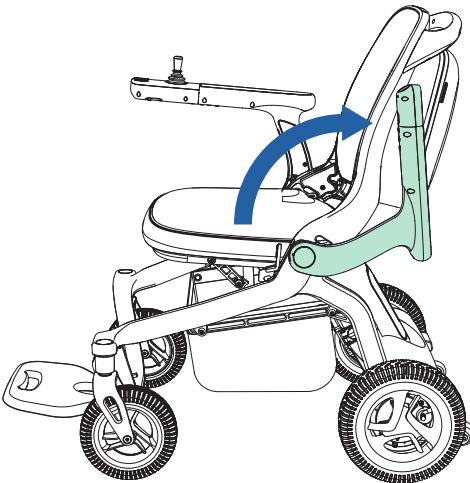

(3) Raise the foot rest with the handle held in hand.

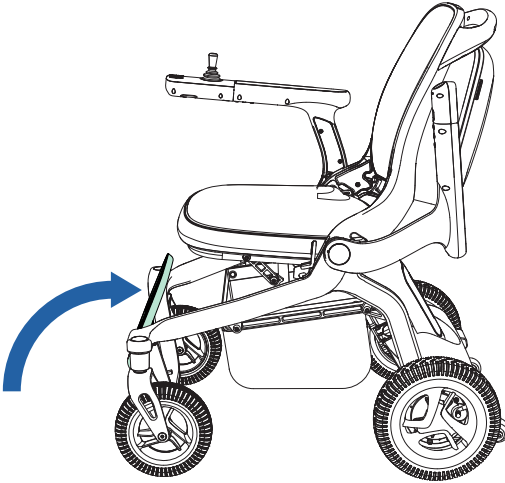

(4) Sit in the seat.



(5) Rotate the arm forward.

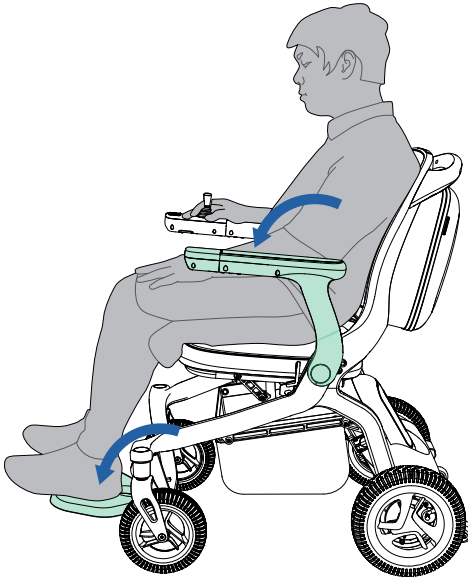

(6) Fasten your seat belts.

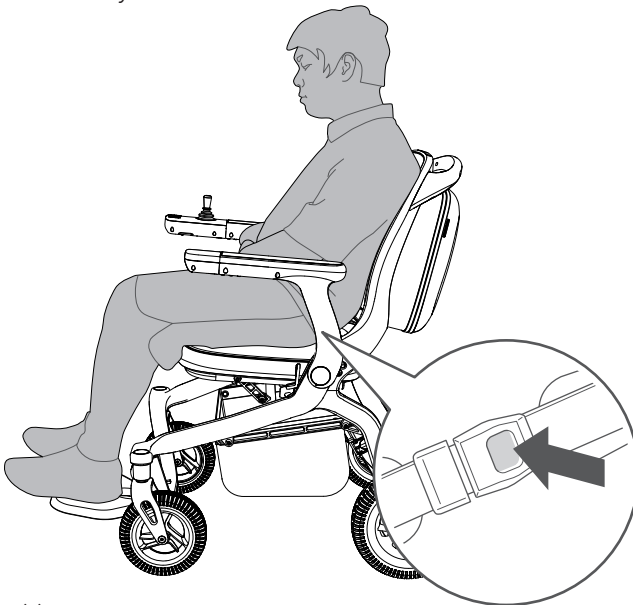

(7) Booting .

(8) Driving.

5.1 Daily spot inspection and maintenance

- The Electric Wheelchair user or operator is responsible for the cleaning, inspection and maintenance;
- General maintenance of the Electric Wheelchair includes: Clean Electric Wheelchairs, check tires, check batteries;
- Inspection: It is recommended that you have the device inspected approximately once every 6 months by your distributor. For details, consult your distributor;
- When the Electric Wheelchair needs to be cleaned, the upper controller should be wiped with the clean towel;
- Regularly (weekly or monthly, depending on the frequency) check the connecting parts (such as screws and nuts) for loosening, falling and corrosion, etc.;
- Regularly check whether the folding parts are stuck, falling off and other conditions;
- Regularly check the tires for aging and serious wear, etc.;
- In case of rain or wet weather, the Electric Wheelchair shall be wiped dry as much as possible to prevent rust due to dampness;
- Electric Wheelchairs should try to avoid exposure to the sun in hot weather.

5.2 Performance fault table of the Electric Wheelchair

Fault code	Anomaly status	Fault phenomenon
E1	Key abnormality	The key corresponding function does not work.
20	The rocker ground line is disconnected	The rocker function does not work.
21	The rocker power cord is disconnected	The rocker function does not work.
22	The rocker X-axis is disconnected	The rocker function does not work.
23	The rocker Y-axis is disconnected	The rocker function does not work.
24	The rocker is a non-zero start	The rocker function does not work.
E6	CAN communication is abnormal	The rocker cannot control the driving of the Electric Wheelchair.
E7	FLASH fault	FLASH device ID cannot be detected and the device cannot work.
82	Left motor Hall fault	The left motor Hall is not connected or faulty, and the motor does not function.
81	Right motor Hall fault	The right motor Hall is not connected or faulty, and the motor does not function.
40	Flat in the electromagnetic brake of left motor	To release the electromagnetic brake handle of left motor, close the electromagnetic brake.
41	Flat in the electromagnetic brake of right motor	To release the electromagnetic brake handle of right motor, close the electromagnetic brake.
80	Low-voltage fault	The motor cannot run.
88	Pre-charge fault	The motor cannot run.
84	Short-circuit fault of lower gear MOS in the right motor	The motor cannot run.
85	Short-circuit fault of upper gear MOS in the right motor	The motor cannot run.
86	Short-circuit fault of upper gear MOS in the left motor	The motor cannot run.
87	Short-circuit fault of lower gear MOS in the left motor	The motor cannot run.
90	High voltage fault	After detecting the high pressure before starting, keep it locked.
91	The Left motor phase loss and disconnection fault	The motor cannot run.
92	The right motor is out of phase and disconnected	The motor cannot run.
93	The Left motor and The right motor are out of phase and disconnected	The motor cannot run.
94	The Right motor stall	The motor cannot run.
95	The Left motor stall	The motor cannot run.
96	Left and right motors are stuck	The motor cannot run.

Table 5.2

5.3 Instruction of safety warning

Voice prompts	Corresponding scene description.
Enter novice mode	Press the novice mode button.
Quit the novice mode	Press the novice mode button again.
Alert	Long press SOS key to trigger SOS.
LOCK	It is in default that after the product is locked after it is powered on. Switch non-locking status to locking status.
Unlock	Switch locking status to non-locking status.
Start the remote control	Voice prompt when the remote control or APP Bluetooth is connected successfully.
car has been locked my bluetooth	Press the lock key.
Upgrade	When the APP detects new version, click to upgrade.
Upgrade complete	End of the single-module upgrade.
Upgrading	The equipment is upgrading.
Powering on tone	Press and hold the power-on key for 3s to start the power-on and the power-on sound.
Key tone	Touch the button to produce a prompt sound.
Charging	Charging
Charging complete	Unplug the charger and trigger the voice prompt of charging completed.
breaks open	The band-type brake opens.
Bluetooth connected	Voice prompt when the remote control or APP Bluetooth is connected successfully.
Drive protection	Voice prompt for a drive failure.
Machine protection	Voice prompt for a machine failure.
Rocker protection	Voice prompt for a rocker failure.
Powering off tone	Press and hold the power-off key for 3s to start the power-off and the power-off sound.
Bluetooth disconnected	Voice prompt when the remote control or APP Bluetooth is disconnected.
Upgrade failed	There is something wrong during upgrading.
The horn sounds	Touch the horn button.
Low battery, please charge	Trigger when the power is lower than 20%.
bluetooth unlocking the car	Press the remote control to unlock.
implementation mode	Long press "∧" button and "∨" button 3 seconds to enter the pushing mode, accompanied by the pushing mode prompt.
Exit implementation mode	Shake the rocker to quit the pushing mode.

Table 5.3

5.4 Production date and service life

- The service life of this product is 5 years after the product is delivered. Please use within the effective date. In case of expiration, Do not use the product to avoid occurrence of accident.
- Refer to product tag for date of production.

5.5 Product cleaning method

Steps1: Wash the pedal plate, fender and wheels with water, then wipe them with a dry towel to make the surfaces dry.

Steps2: Wipe the seat, backrest, armrest and control panel with a wet towel, then wipe them with a dry towel to make the surfaces dry.

Steps3: Visually inspect the surface of the device for dirt or stains. If any dirt or stains are present, repeat steps 1 and 2 until the surface is clean.

Download APP

Scan the QR code to download Mobile Application



Install APP

(Android)

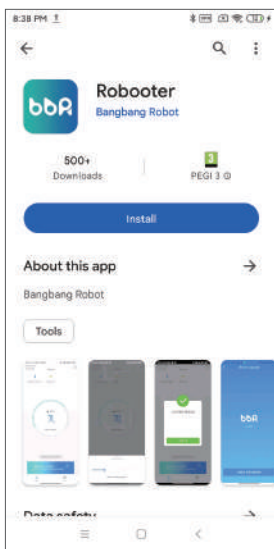

The above screen is displayed after scanning, click **Install** to install the mobile application.

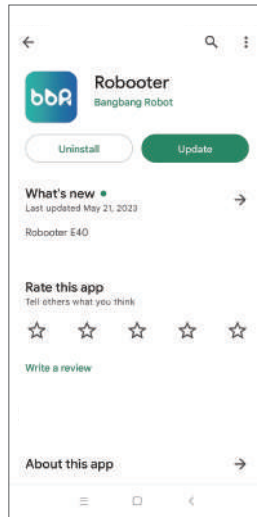

The above screen indicates that the installation of the mobile application is complete.

Click  on the above screen to open the mobile application

(IOS)

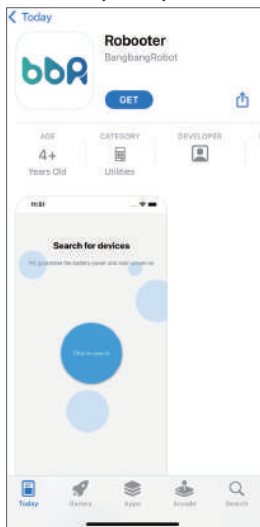

The above screen is displayed after scanning, click **GET** to install the mobile application.

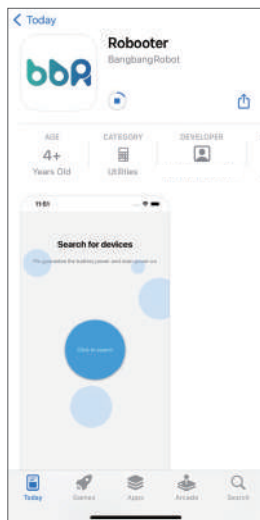

The above screen indicates that the mobile application is being installed

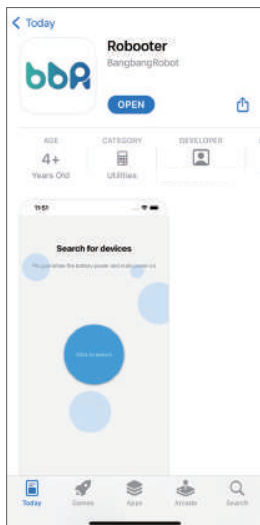

The above screen indicates that the installation of the mobile application is complete. Click **OPEN** on the above screen to open the mobile application

Connect Device

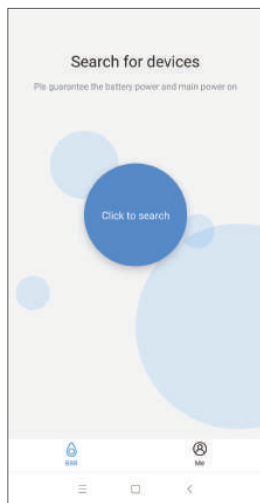

Click **Click to search** on the above screen to search device.

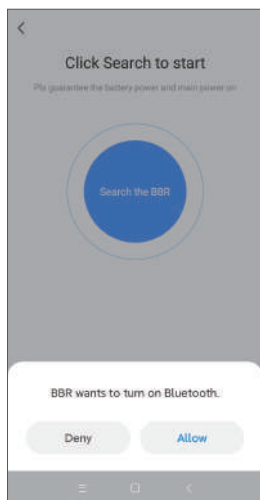

Note: Obtain phone permissions

Click **Allow** on the above screen to turn on your mobile's Bluetooth

Install APP

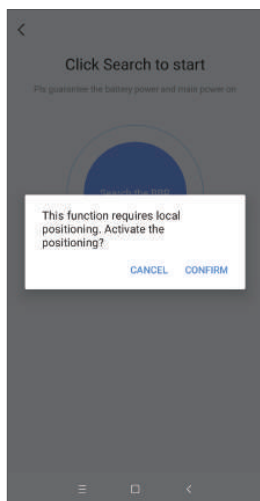

Note: Obtain phone permissions

Click **CONFIRM** on the above screen to turn on your phone's location.

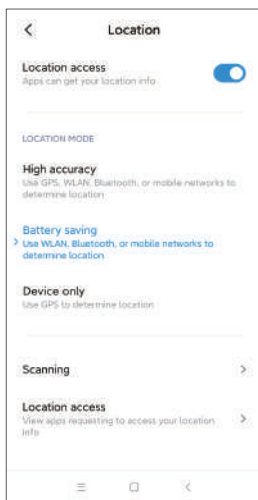

Note: Obtain phone permissions

Click "Location access" on the above screen to turn on your phone's location.

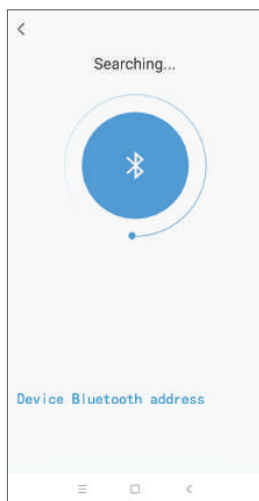

Once the above operation has been done mobile application start searching for the device. Click `DF:85EC:73:15:05` to pair the mobile application and device.

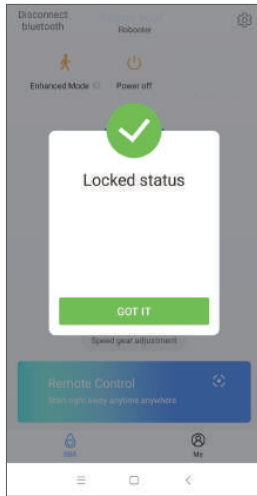

Note:When the wheelchair is in lock mode, display this interface. After turning on the wheelchair, enter the lock mode automatically. Only use the app after unlocking on the wheelchair.

The above screen indicates a successful connection.

Click **GOT IT** in the above screen to access status screen of the Electric Wheelchair

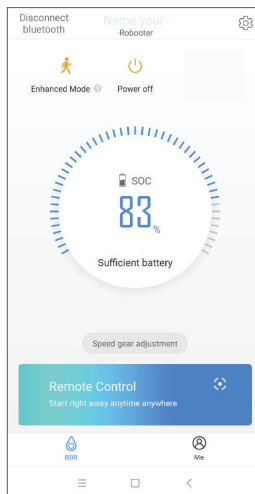

Click  to turn off the device.

Click  to disconnect the bluetooth connection.

Click  to adjust the device speed.(Adjustable speed in 5 gears)

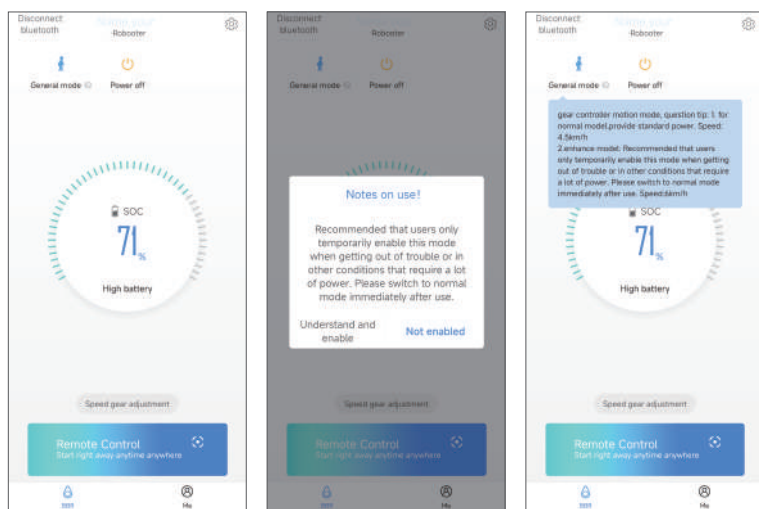

Click  in status screen to access enhanced mode adjustment and general mode adjustment. (General mode speed:3.7mph, enhanced mode speed:5mph)

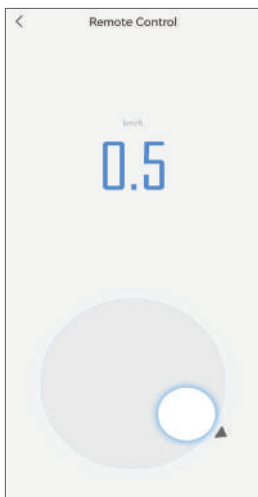

Click **Remote Control** in the status screen to access the remote control mode
Circle up to move forward, down to move back, left to turn left, right to turn right.

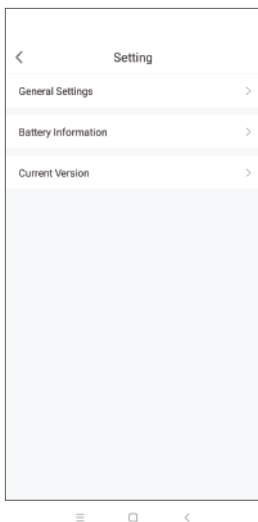

Click  in the top right corner to access the setting screen

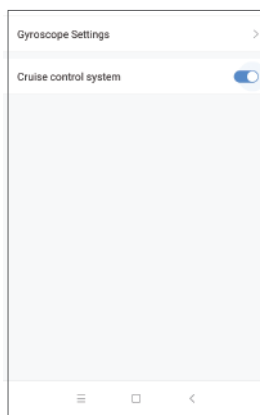

Click "General Settings" in the setting screen to access the general settings mode.

Cruise control system: slide left to turn off cruise control, slide right to turn on cruise control.

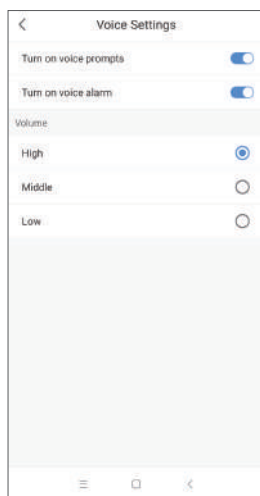

Click "Voice settings" in the General settings to access the voice settings mode.

Turn on voice prompts: slide left to turn off voice, slide right to turn on voice.

Turn on voice alarm: slide left to turn off voice, slide right to turn on voice.

Adjustable 3-step volume: High, Middle, Low.

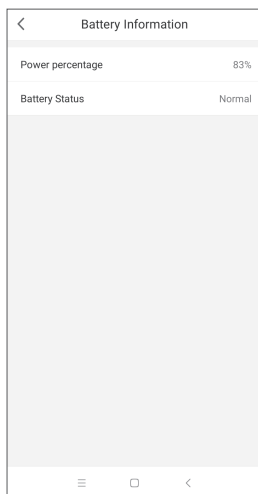

Click "Battery information" in the setting screen to access battery information screen.
Shows battery power percentage and battery status.

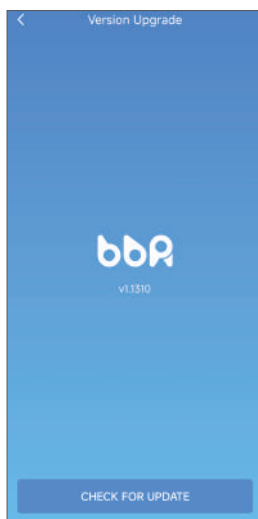

Click "Current Version" in the setting screen to access version upgrade mode.
Show current device version.
Click [CHECK FOR UPDATE](#) to upgrade version of device.

We recommend the user creates strong password for mobile phone, to avoid illegal intrusion of equipment.

Please download the App by scanning the QR code in the manual at any time.

Please only update the App through google play (for Android phone) or app store (for iphone) at any time.

Please do not install APPs on jailbroken phones.

8.1 Wireless functions description

The wheelchair can be controlled by mobile phone via Bluetooth 4.1(IEEE 802.15.4 Bluetooth) technology.

8.2 operating characteristics of the wireless technology

- Protocol: Bluetooth 4.1
- Frequency band: 2.4GHz ISM frequency band
- Frequency: 2.400GHz ~ 2.4835GHz GHz
- Modulation technology: GFSK
- Spread spectrum technology: Frequency-Hopping
- Output power: +4dBm~-20dBm (in 4dB steps)
- Sensitivity: -93dBm(BLE mode)
- Distance:<10m

8.3 Wireless security measures

At the application layer, AES128 is used to re-encrypt the interactive data by hardware. The 128-bit initial password will be calculated by the feature code of the interactive parties according to the algorithm, and will be continuously updated and synchronized during the connection process. Since there are dynamic random change codes and sequence codes in the data, the actual data sequence of each communication is changing, and the real data will be seen after decryption. If the data is incorrect or the content verification is illegal several times, the connection will be interrupted and the blacklist will be added at the same time, until the coverage can be removed. Ensure that the signal is transmitted as expected.

8.4 Information addressing wireless issues

If mobile phone cannot control the wheelchair correctly, please stop use mobile phone and use the button on wheelchair immediately.

Please remove other wireless devices from the environment, and connect mobile phone to wheelchair again, try controlling wheelchair with mobile phone. Do not use mobile phone until mobile phone can control the handpiece correctly.

8.5 Information about any wireless coexistence issues and mitigations

When using the mobile phone, try to keep other wireless devices away from the wheelchair, at least 2m away.

8.6 RF wireless communications information

This device complies with part 15 of the FCC Rules. Operation is subject to the following two conditions:

- (1) This device may not cause harmful interference.
- (2) this device must accept any interference received, including interference that may cause undesired operation.

8.7 Warnings

- a. Stay away from environment where the intensity of EM DISTURBANCES is high.
- b. Does not operate device if performance is lost or degraded due to EM disturbances.
The use of accessories and cables other than those specified or provided by manufacturer could result in increased electromagnetic emission or decreased electromagnetic immunity of the device and result in improper operation
- c. During working, the use of the device adjacent to other device should be avoided because it could result in improper operation. In case such use is necessary, the device and other device should be observed to verify that they are operating normally.
- d. During working, Portable RF communications equipment (including peripherals such as antenna cables and external antennas) should be used no closer than 30 cm (12 inches) to any part of the device, including cables specified by manufacturer. Otherwise, degradation of the performance of this equipment could result.
- e. WARNING: Common RF emitters nearby (radio-frequency identification (RFID) readers, electronic security systems (e.g., metal detectors, electronic article surveillance), near-field communications (NFC) systems, wireless power transfer (WPT) and unique medical emitters such as electrocautery, MRI, electrosurgical units, and diathermy equipment) may produce EMI, please stay away from these devices as much as possible during use.

8. Wireless technology and functions

The Robooter E40 Product Manual is the intellectual property rights of Shanghai Bangbang Robotics Co., Ltd. (hereinafter referred to as "the Company"); The copyright belongs to the Company. This product (including accessories and software design) is developed or produced by Bangbang, and the intellectual property rights and the property rights shall belong to the Company. Without the written permission of the Company, it is not allowed to copy, extract or translate any content of this manual and the content herein.

The Company compiles Robooter E40 Product Manual with the responsible attitude. However, the Company does not guarantee its accuracy. Robooter E40 Product Manual is a technical document, without any content of insinuation or alluding to third parties. The Company undertakes no responsibilities for the misunderstanding of the users due to printer's error. The Company does not take any responsibility for it.

All the products of Shanghai Bangbang Robotics Co., Ltd. used by the users shall be operated strictly in accordance with Robooter E40 Product Manual and the official web of the Company (<https://www.roboteer.com>). During use, it is not allowed to violate the prohibited items indicated in the Product Manual. If the users or the third parties fail to operate strictly in accordance with the Robooter E40 Product Manual or operate by violating the prohibited items indicated in Robooter E40 Product Manual, resulting in personal injuries or property damages, the corresponding legal responsibilities shall be undertaken by specific executors.

The products of the Company are improved and updated constantly. The users shall log on the official web of Shanghai Bangbang Robotics Co., Ltd. to inquire the operating instructions and the updating information of operating conditions, or ask the dealers for the updated Product Manual. The Company reserves the right of modifying the Robooter E40 Product Manual without further notice.

10. Packing list

S/N	Material name	Unit	Quantity	Remarks
1	Electric Wheelchair	Set	1	Included battery
2	Product Manual	Number	1	
3	Charger	Pcs	1	
4	Toolkit	Pcs	1	Including hexagon wrench, open wrench, screw
5	Clean towel	Pcs	1	

Table 9

MedWatch is the Food and Drug Administration's (FDA) program for reporting serious reactions, product quality problems, therapeutic inequivalence/failure, and product use errors with human medical products, including drugs, biologic products, medical devices, dietary supplements, infant formula, and cosmetics.

If you think you or someone in your family has experienced a serious reaction to a medical product, you are encouraged to take the reporting form to your doctor.

Your health care provider can provide clinical information based on your medical record that can help FDA evaluate your report.

However, we understand that for a variety of reasons, you may not wish to have the form filled out by your health care provider, or your health care provider may choose not to complete the form. Your health care provider is not required to report to the FDA. In these situations, you may complete the Online Reporting Form yourself.

You will receive an acknowledgement from FDA when your report is received. Reports are reviewed by FDA staff. You will be personally contacted only if we need additional information.

Submitting Adverse Event Reports to FDA 6 of 16 Use one of the methods below to submit voluntary adverse event reports to the FDA:

Report Online at <https://www.accessdata.fda.gov/scripts/medwatch/index.cfm?action=reporting.home>













Consumer Reporting Form FDA 3500B.

Follow the instructions on the form to either fax or mail it in for submission.

For help filling out the form, see MedWatchLearn. The form is available at www.fda.gov/downloads/aboutFDA/reportsmanualsforms/forms/ucm349464.pdf

Call FDA at 1-800-FDA-1088 to report by telephone.

Reporting Form FDA 3500 commonly used by health professionals. The form is available at www.fda.gov/downloads/aboutFDA/reportmanualsforms/forms/ucm163919.pdf

	Medical device	this symbol Indicates the item is a medical device
	Manufacture	Indicates the medical device manufacturer
	Date of manufacture	This symbol indicates the date of manufacture of the device or accessories.
	Batch code	Indicates the manufacturer's batch code so that the batch or lot can be identified.
	Serial number	Indicates the manufacturer's serial number so that a specific medical device can be identified.
	Use-by date	Indicates the date after which the medical device is not to be used.
IPX4	IP code	X represents the lack of testing for solid objects, while the number 4 indicates the waterproof level of the device. Specifically, a rating of 4 means that the device is protected against splashing water from any direction, such as water droplets from any angle, but cannot withstand immersion or water jets.
		Indicates separate collection for waste of electrical and electronic equipment (WEEE).
	Authorized representative in the European Community	Indicates the authorized representative in the European Community.
		Maximum number of identical transport packages/items which may be stacked on the bottom package, where "n" is the limiting number.
		This is the correct upright position of the distribution packages for transport and/or storage.
		Distribution packages shall be kept away from rain and be kept in dry conditions.
		Contents of the distribution packages are fragile therefore it shall be handled with care.

Service guaranteeer

Dear user:

For the warranty:

1. We offer 1 year warranty for the product Wispex (excluding the accessories).
2. The following circumstance does not belong to the scope of free warranty:
 - a) Using the product did not follow the matters needing attentions in user's manual;
 - b) Disassembling the product by yourself
 - c) Altering the invoice or without the invoice.
3. Fill up the following information, then send it back to us with our products

User's Name: _____

Telephone Number: _____

Address: _____

Trouble Description:

(The information such as: When, Where and How it happened. How many times)

Shanghai BangBang Robotics Co., Ltd.

ADD: Room 501, Building 3, No. 188 Zhongchen Road,

Songjiang District, Shanghai

Tel: 0086213777720

Website: www.bangbangrobotic.com

City	ADD	Postcode	Contact person	Tel
Chicago	1111 W 35th St	30309	Hill	844-940-0001
Piscataway	250 Circle Drive North	08854	Zoey	
Rancho Cucamonga	10767 7th St	91730	Emy	
North York	Unit B1, 601 Gordon Baker Rd	M2H 3B8	Xu	

ROBOOTER



Shanghai BangBang Robotics Co., Ltd.

ADD:Room 501, Building 3, No. 188 Zhongchen Road,
Songjiang District, Shanghai

Tel: 0086213777720

Email: info@bangbangrobotics.com

Website: www.bangbangrobotic.com

Revision date:20230928
file No.: BBR-QP-BOX-01, Rev.VF1.1