

# Owner's Manual



➤ S335 / S331



➤ S345 / S341

## Quick Reference Guide

### S335

1. Tiller
2. Control Panel
3. Tiller Adjustment Lever
4. Removable Seat
5. Adjustable Armrest
6. Rear Light
7. Free Wheel Lever
8. Anti-Tip Wheels
9. Seat Pivot Lever
10. Rug
11. Front Bumper
12. Headlight
13. Front Basket
14. Turn Signal
15. Seat Position Adjuster

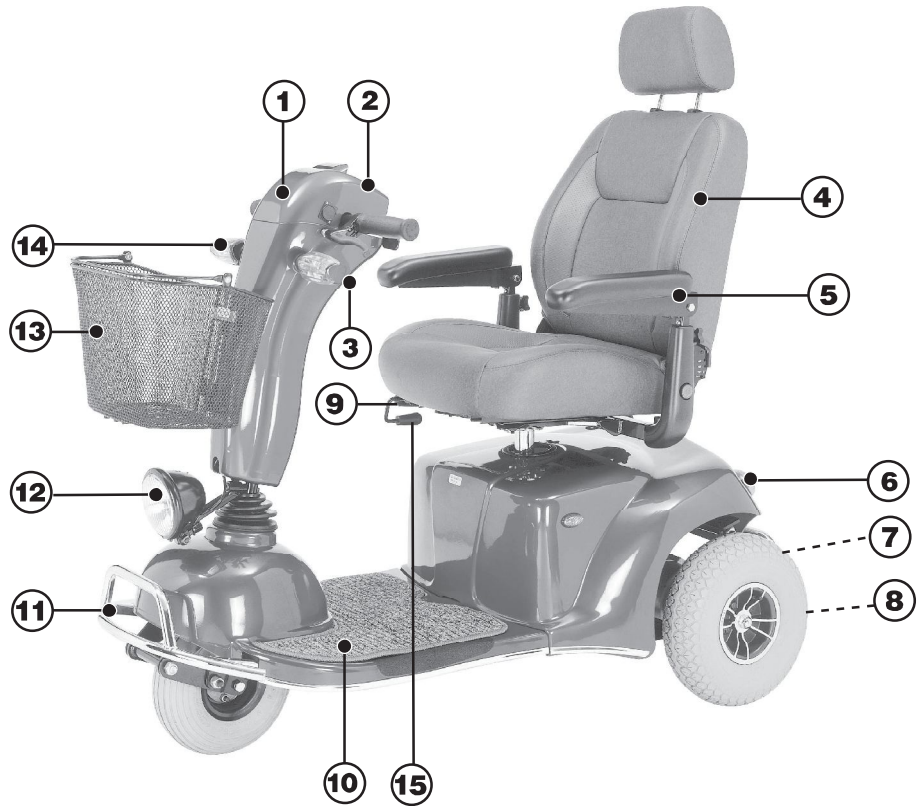

## Quick Reference Guide

### S345

1. Tiller
2. Control Panel
3. Tiller Adjustment Lever
4. Removable Seat
5. Adjustable Armrest
6. Rear Light
7. Free Wheel Lever
8. Anti-Tip Wheels
9. Seat Pivot Lever
10. Rug
11. Front Bumper
12. Headlight
13. Front Basket
14. Turn Signal
15. Seat Position Adjuster

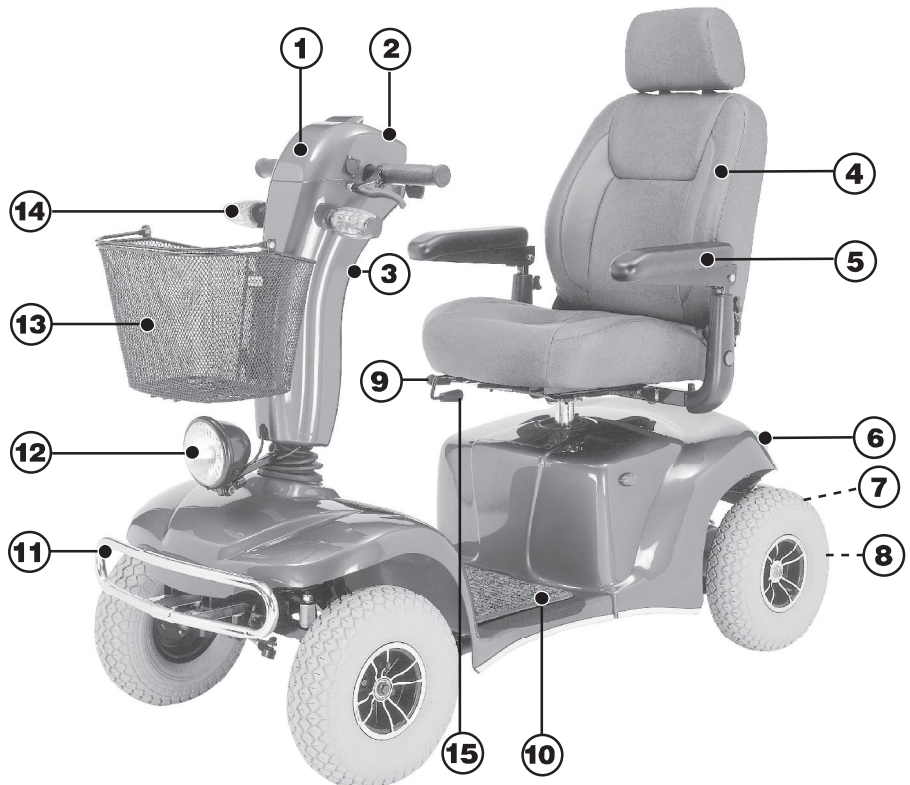

Welcome aboard your new Scooter. We wish to thank you for letting us improve your freedom and independence. This model has been designed with your practical needs in mind. It is equipped with modern high-tech electronics and special features for a more comfortable ride. Its safety and performance will provide you with years of excellent service and pleasure.

## Table of Contents

Introduction	
Practice before operating	1
Safety Instructions	
Safety Considerations	3
Driving Outside	6
Driving on Hills	8
Getting to Know Your Scooter	
Parallel Tiller	10
Charging the Batteries	11
Disassembling the Scooter	12
Operating your scooter	
Controls (Digital dashboard)	13
Controls (Analog dashboard)	16
Seat Adjustment	18
Tiller Angle Adjustment	19
Free Wheel Mode	19
Specifications	20
Ice Symbols	21
Warranty	22

Failure to follow these instructions may result in damage to the scooter or serious injury.

### ■ Practice before operating

Find an open area such as a park and have an assistant to help you practice until you have confidence operating this vehicle.

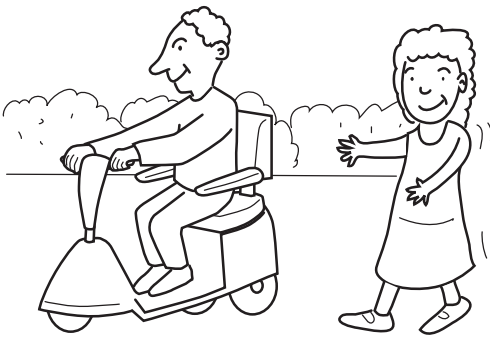

Make sure that the unit is off before getting in or out of it. Set the speed control knob according to your driving ability.

**We recommend that you keep the speed at the slowest position (fully counter-clockwise) until you are familiar with the driving characteristics of this vehicle.**

Stop, forward, and reverse operation practice

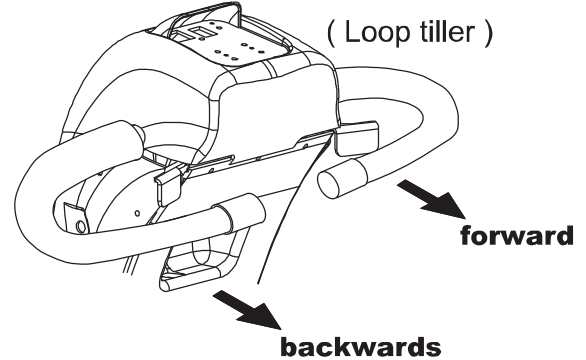
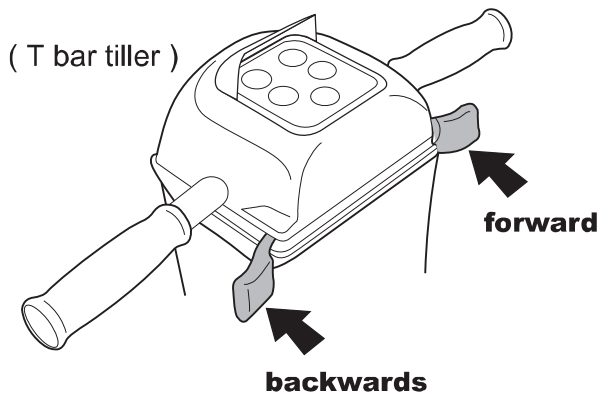

## Getting familiar with this vehicle

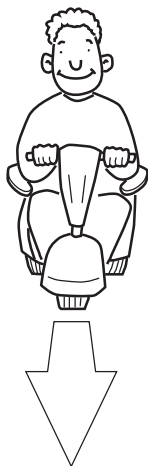

First, practice moving forward.  
Be sure to set the speed to the lowest setting.

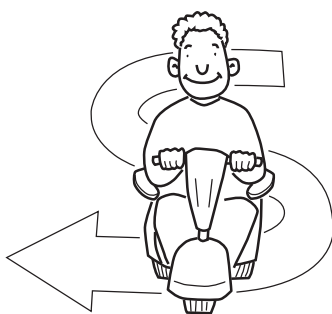

After becoming familiar with moving forward, practice making "S" turns.



Once you are familiar with "S" turns, practice moving in reverse.

■ Safety considerations

DO NOT do any of the following:

Do not carry any passengers

**NO!**



Do not drive across a slope

**NO!**



Do not drink and drive

**NO!**



Do not tow a trailer

**NO!**



Do not turn on or use hand-held personal communication devices such as citizens band (CB) radios and cellular phones

**NO!**



This vehicle has an immunity level of 20 v/m which should protect it from Electromagnetic Interference (EMI) from Radio Wave Sources. The rapid development of electronics, especially in the area of communications, has saturated our environment with electromagnetic (radio) waves that are emitted by television, radio and communication signals. These EM waves are invisible and their strength increases as one approaches the source. All electrical conductors act as antennas to the EM signals and, to varying degrees, all power wheelchairs and scooters are susceptible to electromagnetic interference (EMI). This interference could result in abnormal, unintentional movement and/or erratic control of the vehicle. The United States Food and Drug Administration (FDA) suggests that the following statement be incorporated to the user's manual for all electric scooters.

Powered wheelchairs and electric scooters (in this text, both will be referred to as powered wheelchairs) may be susceptible to electromagnetic interference (EMI), which is interfering electromagnetic energy emitted from sources such as radio stations, TV stations, amateur radio (HAM) transmitters, two-way radios and cellular phones. The interference (from radio wave sources) can cause the powered wheelchair to release its brakes, move by itself or move in unintended directions. It can also permanently damage the powered wheelchair's control system. The intensity of the EM energy can be measured in volts per meter (V/m). Each powered wheelchair can resist EMI up to a certain intensity. This is called the "immunity level." The higher the immunity level, the greater the protection. At this time, current technology is capable of providing at least 20 V/m of immunity level which would provide useful protection against common sources of radiated EMI.

Following the warnings listed below should reduce the chance of unintended brake release or powered wheelchair movement that could result in serious injury:

- 1) Do not turn on hand-held personal communication devices such as citizens band (CB) radios and cellular phones while the powered wheelchair is turned on.
- 2) Be aware of nearby transmitters such as radio or TV stations and try to avoid coming close to them.

- 3) If unintended movement or brake release occurs, turn the powered wheelchair off as soon as it is safe.
- 4) Be aware that adding accessories or components, or modifying the powered wheelchair, may make it more susceptible to interference from radio wave sources. (Note: there is no easy way to evaluate their effect on the overall immunity of the powered wheelchair).
- 5) Report all incidents of unintended movement or brake release to the powered wheelchair manufacturer, and note whether there is a radio wave source nearby.

**TURN OFF YOUR SCOOTER AS SOON AS POSSIBLE WHEN EXPERIENCING ANY OF THE FOLLOWEING:**

1. Unintentional motions.
2. Unintended or uncontrollable direction.
3. Unexpected brake release.

The FDA has written to the manufacturers of power wheelchairs, asking them to test their new products to be sure they provide a reasonable degree of immunity against EMI. The letter says that powered wheelchairs should have an immunity level of at least 20 V/m, which provide a reasonable degree of protection against the more common sources of EMI. The higher the level, the greater the protection.



■ Driving outside

When you are on the road, please pay attention to the following:

Do not drive in heavy traffic

**NO!**

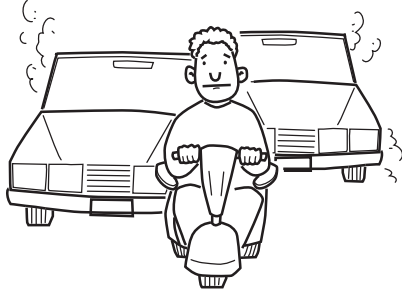

Do not drive beside a river, port, or lake without a fence or railing

**NO!**



Do not drive during the rain

**NO!**



Do not drive during or on snow

**NO!**



Do not drive off-road or on any uneven surfaced roads

**NO!**



Be sure to use the headlights when driving at night

**NO!**



**NO!**



Make sure that there are no obstacles behind you when in reverse.

We recommend to set the speed knob at the lowest speed (🐢) for reversing

**NO!**



Do not make sudden stops, weave erratically, or make sharp turns.

**NO!**



Keep your arms on or inside the armrests and feet on the footrest at all time.

**NO!**



Do not attempt to climb curbs greater that 2"(5cm).

**NO!**



Do not attempt to cross over a gap greater that 4"(10cm).

## ■ Use caution when driving on hills

Driving on hills is more dangerous than on level surfaces. If you fail to heed these warnings, a fall, tip-over or loss of control may occur and cause severe injury to the vehicle user or others.

**NO!**

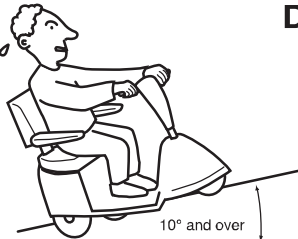

Do not attempt to climb a hill greater than 10°

**NO!**



Do not reverse while driving up a hill.

Forward only. If you reverse while moving up a hill, it may cause the vehicle to tip over.

**NO!**



Do not attempt to drive across a sloping surface greater than 3°

Driving across a slope greater than 3° is very dangerous and may cause the vehicle to tip over.

**NO!**



Use caution when driving over soft, uneven or unprotected surfaces such as grass, gravel and decks.

**NO!**



**Use low speed while driving down hill.**

When going down hill, the tiller will become harder to reach and handle. When braking while moving down hill, the scooter will take longer to come to a complete stop.

**NO!**

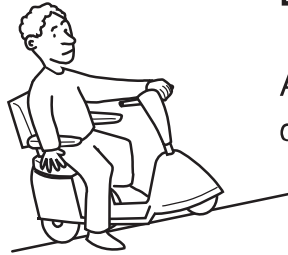

**Do not get in and out on a hill.**

Always stop on the level surface to get in and get out of the vehicle.

**NO!**



**Do not load or carry heavy items in the basket while driving down hill.**

**YES!**



**Always climb or descend gradients perpendicular to the slope or ramp.**

In this section, we will acquaint you with the many features of your scooter and how they work. Upon receipt of your scooter, inspect it for any damage. Your scooter consists of a frame assembly, drivetrain assembly, seat assembly, tiller assembly, battery charger, and owner's manual. Contact your sales agent if any question arise.

## Parallel Tiller

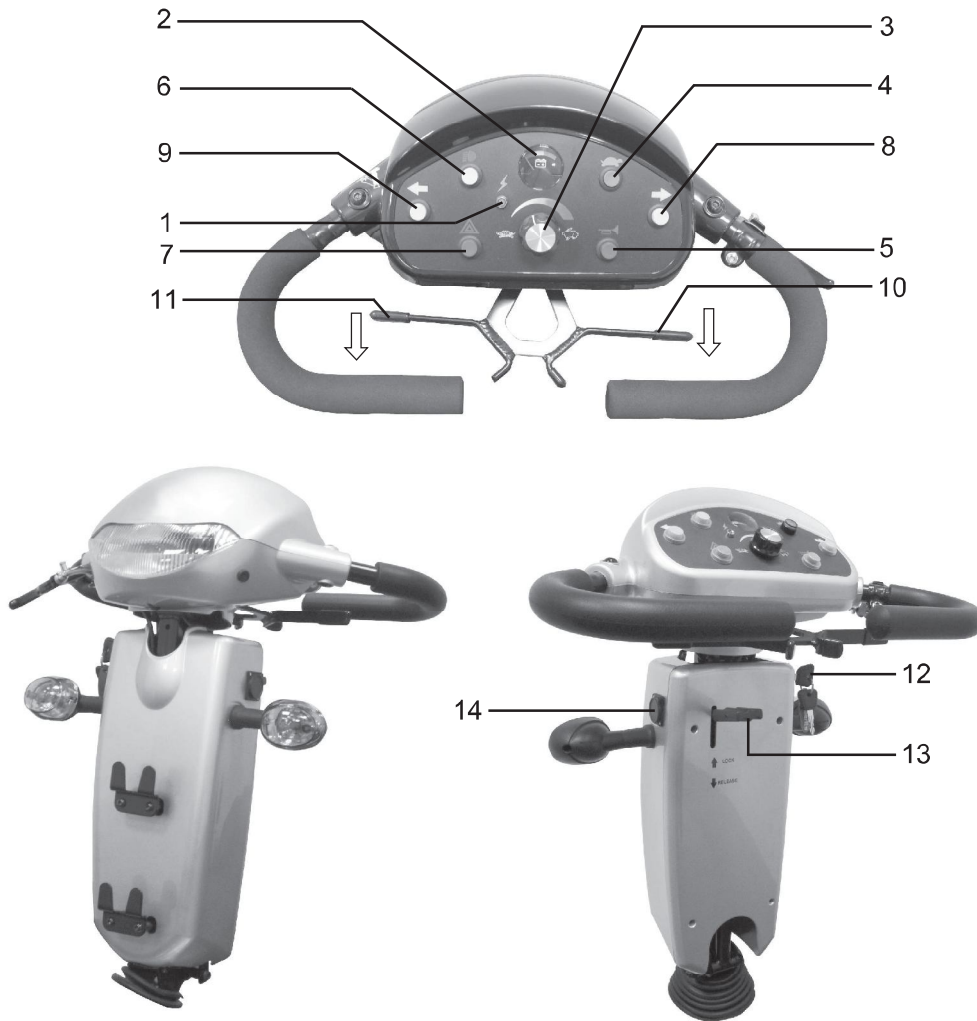

1. Status indicator
2. Battery condition meter
3. Speed adjustment dial
4. Half speed button
5. Horn
6. Light button
7. Hazard light button

8. Turn signal button (R)
9. Turn signal button (L)
10. Throttle control lever (forward)
11. Throttle control lever (backwards)
12. Key switch
13. Tiller angle adjustment lever
14. Off board charger receptacle

## Batteries

Your scooter is equipped with maintenance free, sealed lead acid batteries. These batteries require no maintenance other than ensuring that they are properly charged. If other batteries are used, check with your battery supplier for proper battery care and maintenance instructions.

Your scooter comes supplied with two battery cables.

Attach the red wire of the first cable to the (+) terminal of the first battery. Attach the black wire of the first cable to the (-) terminal of the first battery. Repeat this procedure for the second battery.

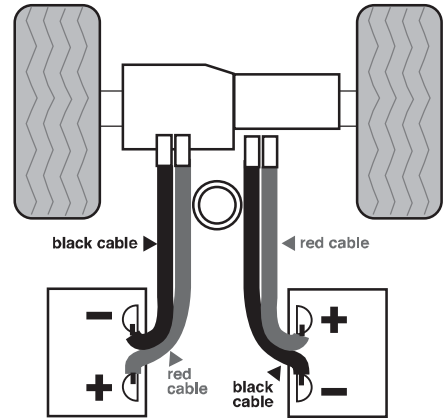

### ■ Charging the Batteries

**Note:** Because your batteries may only have a partial charge when you first receive your scooter, you may not experience full riding time until you have fully charged them. Your scooter is equipped with an on-board batter charger. Charging your batteries as specified below will ensure maximum life, power, and range.

**⚡ WARNING! ⚡**  
Use of a non-grounded receptacle could result in an electric shock

### Using On Board Charger

1. Turn off the power on the scooter.
2. Plug the charger cable into an outlet.
3. Plug the cable into the power socket at the rear of the scooter. (You will need to flip up the rubber safety covering on the power socket)
4. Leave the scooter to charge. As it charges, you will see progress lights in the clear circular window next to the charger socket. A RED light means the charger is ready to use, a WHITE light means charging is in progress, and a GREEN light means the charger is finished, and the scooter is fully charged.

### Using Off Board Charger

- Follow steps 1 and 2 as above.
3. Plug the charger cable into the power socket on the tiller. (You will need to flip up the rubber safety covering on the power socket)
  4. Leave the scooter to charge. As it charges, you will see progress lights on the charger unit. A RED light means the charger is ready to use, a WHITE light means charging is in progress, and a GREEN light means the charger is finished, and the scooter is fully charged.

## ■ Disassembling the Scooter (2 piece frames)

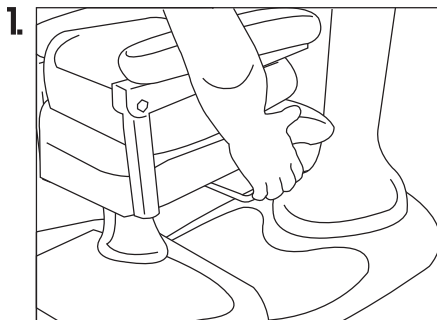

move the tiller to the forward position, pull up on seat release and remove seat.

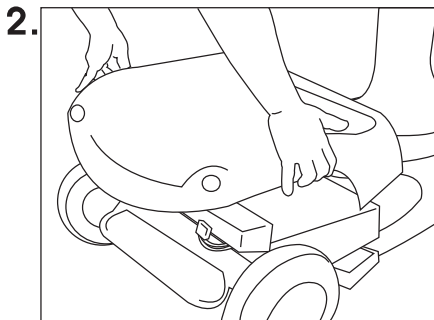

remove cover.

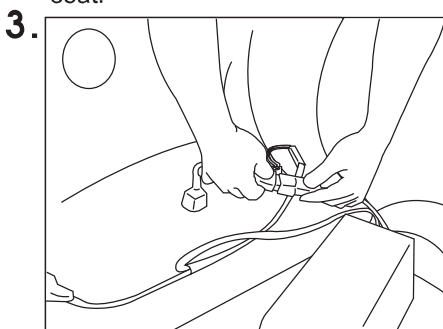

disconnect the turn signal light cable and charger cable.

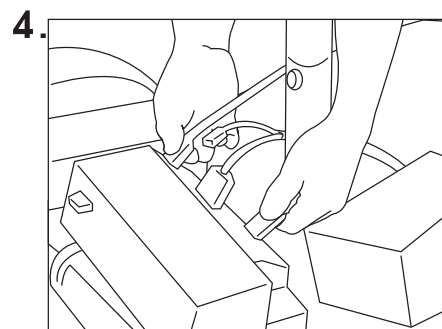

disconnect both batteries.

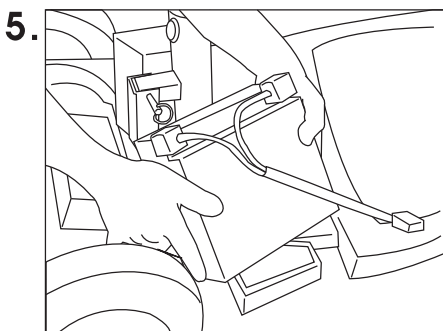

remove both batteries.

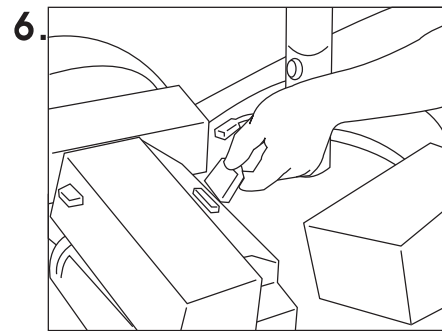

disconnect the white connector.

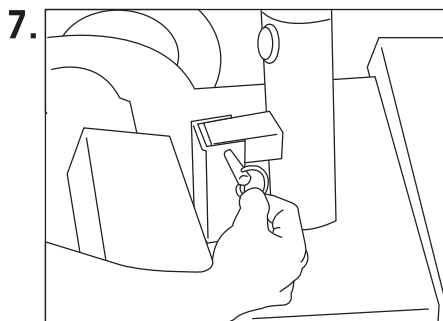

remove the connecting pin.

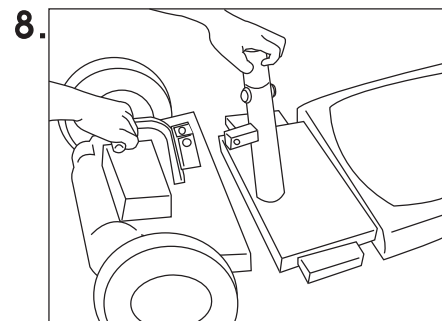

pull the motor section away from the footrest section.

## ■ Controls (Digital dashboard)

Only drive within your control limitations. Loss of control of your scooter could result in serious injury to yourself or others. If your speed becomes difficult to control, release the speed lever and your scooter will come to a complete stop. Only use the on/off switch to stop your scooter in an emergency.

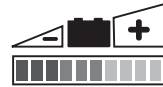
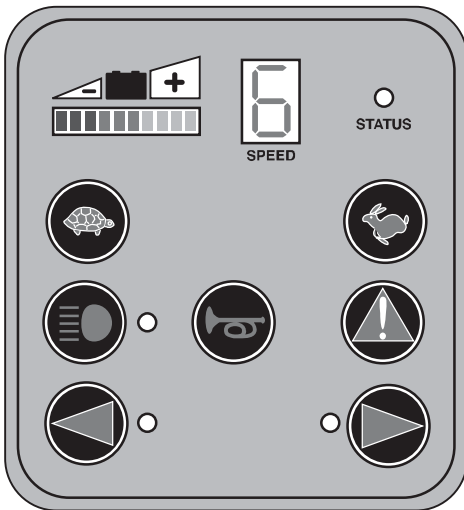

**Battery Level Indicator:** Indicates the charge level of the batteries. If only the red LEDs are on, the batteries need to be charged as soon as possible. If the LEDs are green, the batteries are fully charged. As the battery charge is depleted, the LEDs will go from green to yellow, and finally to red.



**Speed Control:** The speed on this scooter is controlled by the buttons on the control panel - one with a TURTLE makes the scooter slower, one with a RABBIT makes the scooter go faster. The speed has a range of 1 (slowest) to 6 (fastest) - each time you press the RABBIT or the TURTLE, it will either increase or decrease the speed 1 level. The current speed setting is shown on the LED indicator.



**Horn:** The horn is activated by pressing the horn button. Releasing the horn button deactivates the horn. The horn is useful to warn people or animals that you are coming towards them. You may also find it helpful to use when rounding blind corners.



**Turn Signals:** Pressing these buttons will activate the turn signal lights. The lights will automatically go off after 15 cycles.





**Headlight:** The headlight is activated by pressing the headlight button. Pressing the button a second time will turn the light off.



**Hazard Light:** The hazard lights are activated by pressing the hazard light button. Pressing the button a second time will turn the light off.

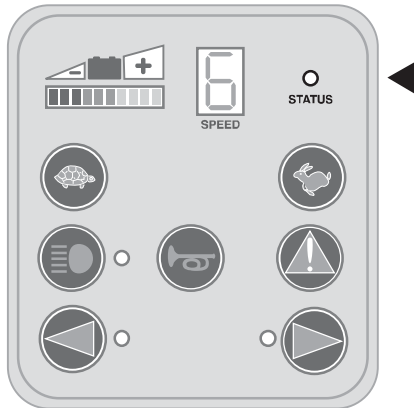

**Status Indicator:** When the scooter is on, and all conditions are normal, the Status Indicator will be on. When there is some special condition that needs attention, the light will flash. See the reference chart below for the meanings of the different flashing patterns.

Number of Flashes	Meaning
1	Battery needs recharging
2	Battery voltage too low
3	Battery voltage too high
4	Current time limit out
5	Brake fault
6	Not in neutral at power up
7	Speed pot error
8	Motor volts error
9	Other internal error

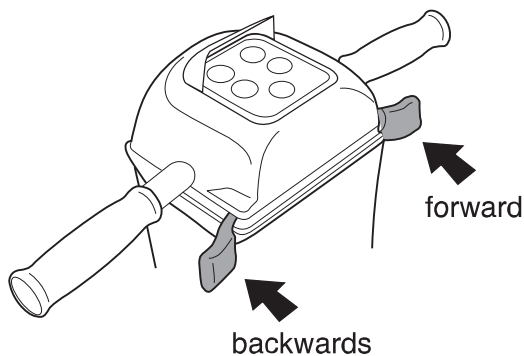

**Forward/Reverse:** Push the right lever to move forward, push the left lever to move backwards.

**Key Switch:** When the key is turned to a vertical position, the scooter is ON and ready to drive. When the key is horizontal, the scooter is OFF.

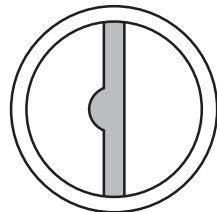

ON

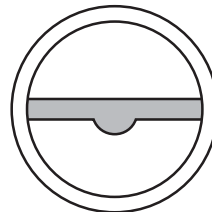

OFF

**Brakes and Throttle control lever:** Whenever the speed lever is pushed, the electromagnetic brake will automatically release and your scooter will move. When the speed lever is released, it will return to the neutral position and the scooter will decelerate and come to a complete stop. The parking to brake will then engage preventing further movement of your scooter.

Your unit is equipped with a programmable controller that has a high peddle disable safety feature. This will prevent unexpected acceleration of the scooter, if the speed lever is being pushed at the same time you turn the key "ON". To reset the controller, release the speed engage lever and turn the key "OFF" for a couple of seconds and then turn it back "ON".



**If your scooter ever moves in an unexpected manner, release the speed lever and turn off the power.**

## ■ Controls (Analog dashboard)

Only drive within your control limitations. Loss of control of your scooter could result in serious injury to yourself or others. If your speed becomes difficult to control, release the speed engager lever and your scooter will come to a complete stop. **Only use the on/off switch to stop your scooter in an emergency.**

**1. Status Indicator:** When the scooter is on, and all conditions are normal, the Status Indicator will glow Green.

If there is a special condition that requires attention, the light will flash a code, which will be repeated after a 2 second pause. Please refer to the "Flash Code" chart below for the codes before contacting your.

- 1: Battery needs recharging
- 2: Battery voltage too low
- 3: Battery voltage too high
- 4: Current time limit out
- 5: Magnetic brake fault
- 6: Not in neutral at power up
- 7: Speed pot error
- 8: Motor volts error
- 9: Other internal error

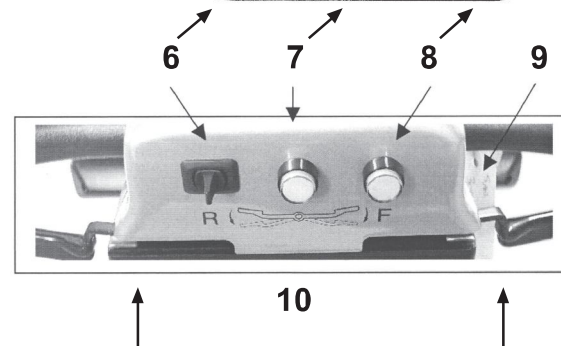

Reverse Lever ← Throttle → Forward Lever  
(Half speed function is optional)

**2. Battery Level Indicator:** When power to the vehicle is turned "ON", the needle on this display will move to the right to indicate the available battery reserve. When the batteries are fully charged, the needle should be well into the green area of the display when the scooter is stationary. If the scooter is being driven at high power consumption levels (i.e. high speeds, up hills and/or with heavy loads) the needle will move progressively to the left and possibly into the red area. This situation is normal but this type of driving is not recommended for prolonged periods. The needle positioned in the red area of the scale when the scooter is stationary indicates very low battery reserves and the scooter should be recharged as soon as possible.

**3.Speed Control:**This knob set the maximum speed of the vehicle. When knob is rotated fully counter clockwise (4), input commands of the throttle levers (9) cause slower vehicle response and speed. As the knob is incrementally turned in a clockwise direction (5), the scooter will move faster for a given command. When learning to drive the vehicle or operating in confined areas, we strongly recommend that the control is set fully counter clockwise.

**4.Slow Speed:**Picture of Tortoise indicates slow setting of speed knob (5).

**5.Fast Speed:**Picture of Hare indicates fast setting of speed knob (5).

**6.Indicator Switch:**Left and right indicators can be operated by gently moving the toggle switch to the left (◀) or right (▶), as desired, if you wish to indicate that turning maneuver to others around you. To cancel the indicators simply return the toggle switch to the central position. You may draw the attention of others to your maneuver by tooting the horn once or twice.

**7.Headlight Switch:**The headlight is activated by gently pressing the headlight button in. The headlight can be turned off by gently pressing the switch again.

**8.Horn:**The horn is activated by pressing the horn button. Releasing the button deactivates the horn. The horn is useful to warn people or animals that you are approaching. You may also find it helpful to use when rounding blind corners.

**9.Half Speed Switch:**The Orange switch next to the ignition switch can be used to manually limit the scooter to a more manageable speed when traveling in confined areas. Gently press the switch to activate this function. A light will glow inside the switch to remind you it is on. Gently press the switch again to release the switch and deactivate this function. When driving at speed (as a safety feature), this function will activate automatically if the steering is turned.

**10.Throttle Levers:**With loop handlebar models, the throttle levers can be activated by finger or thumb, depending on personal preference. The throttle is progressive and can be used to regulate the speed up to the setting of the speed control knob (3).

**To travel forward:**gently pull the right lever back toward you with your right finger(s), or push the left lever away from you with your left thumb, until the desired speed is achieved.

**To travel backwards:**gently pull the left lever back toward you with your left finger(s), or push the right lever away from you with your right thumb, until the desired speed is achieved.

**NB:***(Polarity of the throttle can be reversed by your dealer if you require left hand finger operation to travel forward).*

## ■ Seat adjustment

### Back rest angle:

- Fold the backrest for easy access.

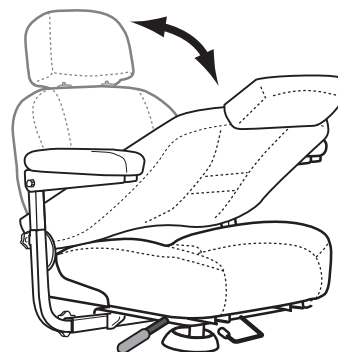

### Seat swivel positions:

The seat swivel lever (located on the side of the seat) allows the seat rotation in 45 degree increments. You may use this feature to make it easier to transfer in and out of the seat.

- Pull the swivel lever up to unlock and rotate the seat.
- Pivot the seat to the position you desire.
- Release the lever and try to turn the seat back and forth slightly allowing the lever to lock into position.



### Armrest height:

- Loosen the clamping nut at the rear of the handle.
- Turn the bolt in to lower the angle of the armrest to your desired angle.



### Armrest width:

- Locate the width clamping nut (follow the armrest support down to the base of the seat).
- Loosen the clamping nut by turning counter-clockwise.
- Pull the armrest in or out to reach your desired position.
- Tighten the width clamping nut.

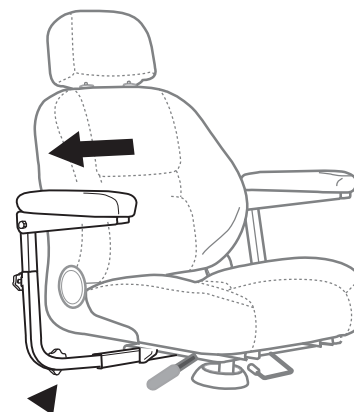

## ■ Tiller Angle Adjustment

The tiller angle adjustment allows you to position the dash closer or further away from you for better access of the controls.

- Locate the angle adjusting lever which is located on the inside center of the tiller boot.
- Hold the weight of the tiller with one hand and loosen the lever by pulling up the lever with the other hand. Pushing down will release the tiller locking mechanism, allowing you to move the tiller freely.
- Release the lever and try to move the tiller back and forth slightly allowing the lever to lock into position.

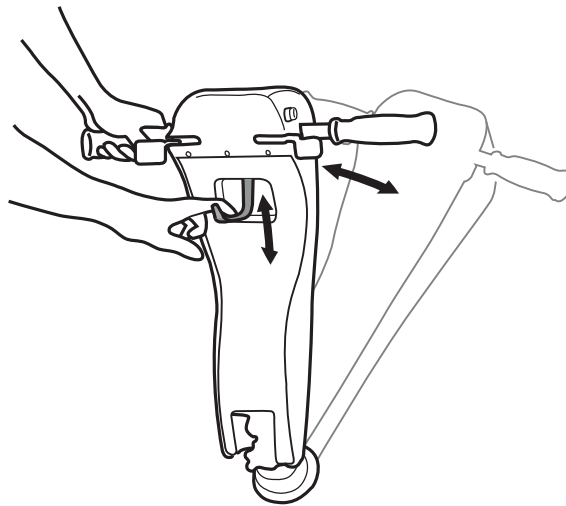

## ■ Free Wheel Mode

**Manual free-wheel mode:** Your scooter features a "free wheel" mode for manual operation. To activate manually, turn the key switch OFF and locate the free-wheel lever at the back, right side of the scooter, near the wheel. Push lever to the "down" position to disengage the brake and allow the scooter to be pushed freely. Pull the lever to the "UP" position to reengage the brake. Remember, when the scooter is in manual free-wheel mode, you will have no brakes. You will be unable to operate the scooter. When you wish to push your scooter a short distance, you may put it into Manual Free-Wheel mode.

**Getting in and out:** Your scooter is designed to make getting in and out of the scooter as easy as possible. Make sure the scooter is on a level surface and the key switch is turned OFF. If necessary, raise the armrest to give you maximum space to transfer in or out of the seat. Once transfer is complete, return the armrest before operating the scooter.







**Never operate your scooter without your feet being placed on the scooter platform. Driving your scooter without your feet on the platform could cause serious bodily injury.**

Model No.	S335 / 331	S345 / 341
Length	49" / 124 cm	54" / 137 cm
Width	27" / 69 cm	
Seat height (from ground)	25" ~ 28" / 64 ~ 71 cm	
Front wheel	10" / 25.4 cm	12-1/2" / 32 cm
Rear wheel	12-1/2" / 32 cm (4.10 / 3.50-5)	
Weight Capacity	350 lbs / 500 lbs	350 lbs / 500 lbs
Speed	max 9.6 mph / 15 kph	
Range	max 32 miles / 50 km	
Turning Radius	50" / 127 cm	62" / 158 cm
Light	Head / Rear Turn signal	
Battery	12V / group 24(73AH) x 2pcs	
Brakes	Intelligent, regenerative brakes	
Anti-tip	2 rear anti-tip wheels	
Bumper	Front / Rear	
Unit Weight	227 lb / 103 kg	247 lb / 112 kg
Charger	6A off-board	

Remark:

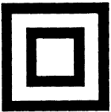
S331/S341 speed: max 8 mph / 12.8 kph (one piece frame)

ICE SYMBOLS	
	Caution, attention or consult accompanying documents.
	Alternating Current
	Type BF Equipment
	Double Insulation
	No Smoking or Naked Flames

Degree of protection against ingress of water is rated as IPx0.

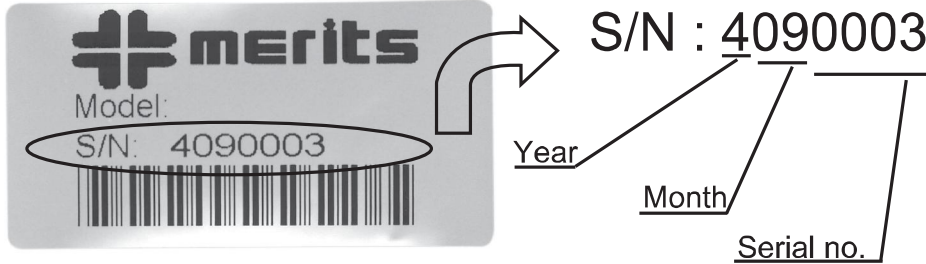
Serialization format for products	
	
1	The first digit is the last one digit of the year for manufacture.
2	The second and third digits are the month for manufacture.
3	The fourth to seventh digits are counting of how many units were manufactured during the month.



## ■ Warranty Registration

### MERITS HEALTH PRODUCTS INC. WARRANTY REGISTRATION

MODEL NO. \_\_\_\_\_

SERIAL NO. \_\_\_\_\_

DATE PURCHASED \_\_\_\_\_

NAME \_\_\_\_\_

ADDRESS \_\_\_\_\_

CITY \_\_\_\_\_ STATE \_\_\_\_\_ ZIP \_\_\_\_\_

DEALER NAME \_\_\_\_\_

STAMP

RETURN ADDRESS

\_\_\_\_\_

\_\_\_\_\_

\_\_\_\_\_



We wish you a safe and comfortable riding experience!





**MERITS HEALTH PRODUCTS, INC.**

[www.meritshealth.com](http://www.meritshealth.com) 730 N.E. 19th Place, Cape Coral, FL 33909  
TEL:1-800-963-7487, 1-239-772-0579 FAX:1-239-574-2661