

***Nikon* XS Series Total Station**

Instruction Manual

Part Number C300E1
November 2017, Revision B

Nikon

www.trimble.com

Contact Information

Nikon Surveying Instruments
10368 Westmoor Drive, Suite #100
Westminster, CO 80021
USA
Phone: +1-720-587-4700
888-477-7516 (Toll Free in U.S.)
sales@nikonpositioning.com

Legal Notices

Copyright and Trademarks

© 2007-2017, Nikon-Trimble Co. Limited. All rights reserved.
All trademarks are the property of their respective owners.
It is prohibited to alter this manual in part or whole without express permission.
The contents of this manual are subject to change without notice.
Although every effort has been made to ensure the accuracy of this manual, please contact your dealer if you find anything in it that is incorrect or unclear.

Release Notice

This is the November 2017 release of the **Nikon XS Series Total Station Instruction Manual Edition 1, Revision B**.

Manufacturer

Nikon-Trimble Co., Ltd.
Technoport Mituiseimei Bldg.
16-2, Minamikamata 2-chome, Ota-ku
Tokyo 144-0035 Japan

Notices

USA

FCC 15B Class B satisfied.

This equipment has been tested and found to comply with the limits for a Class B digital device, pursuant to Part 15 of the FCC Rules. These limits are designed to provide reasonable protection against harmful interference in a residential installation. This equipment generates, uses and can radiate radio frequency energy and, if not installed and used in accordance with the instructions, may cause harmful interference to radio communications. However, there is no guarantee that interference will not occur in a particular installation.

If this equipment does cause harmful interference to radio or television reception, which can be determined by turning the equipment off and on, the user is encouraged to try to correct the interference by one or more of the following measures:

- Reorient or relocate the receiving antenna.
- Increase the separation between the equipment and receiver.
- Connect the equipment into an outlet on a circuit different from that to which the receiver is connected.
- Consult the dealer or an experienced radio/TV technician for help.



Warning – This equipment has been certified to comply with the limits for a Class B personal computer and peripherals, pursuant to Subpart B of Part 15 of FCC Rules. Only peripherals (computer input/output devices, terminals, printers, etc.) certified to comply with the Class B limits may be attached to this equipment. Operation with non-certified personal computer and/or peripherals is likely to result in interference to radio and TV reception. The connection of a non-shielded equipment interface cable to this equipment will invalidate the FCC Certification of this device and may cause interference levels which exceed the limits established by the FCC for this equipment.

You are cautioned that changes or modifications not expressly approved by the party responsible for compliance could void your authority to operate the equipment.

European Union

EU RE Directive satisfied.

Authorized Representative in Europe

Trimble GmbH
Am Prime Parc 11
65479 Raunheim, Germany



Canada

This Class B digital apparatus meets all requirements of the Canadian Interference-Causing Equipment Regulations.
Cet appareil numérique de la Class B respecte toutes les exigences du Règlement sur le matériel brouilleur du Canada.

Taiwan

Battery Recycling Requirements

The product contains a removable battery. Taiwanese regulations require that waste batteries are recycled.



Notice to Our European Union Customers

For product recycling instructions and more information, please go to:
www.trimble.com/environment/summary.html



Recycling in Europe

To recycle Trimble WEEE, call: +31 497 53 2430, and ask for the “WEEE associate,” or mail a request for recycling instructions to:
Trimble Europe BV
c/o Menlo Worldwide Logistics
Meerheide 45
5521 DZ Eersel, NL

For Bluetooth unit

USA

FCC Part 15 Subpart C/RSS-210, OET bulletin 65 supplement C satisfied



Caution – Any changes or modifications not expressly approved by the party responsible for compliance could void the user's authority to operate the equipment.

NOTE: This equipment has been tested and found to comply with the limits for a Class B digital device, pursuant to part 15 of the FCC Rules. These limits are designed to provide reasonable protection against harmful interference in a residential installation. This equipment generates, uses and can radiate radio frequency energy and, if not installed and used in accordance with the instructions, may cause harmful interference to radio communications. However, there is no guarantee that interference will not occur in a particular installation. If this equipment does cause harmful interference to radio or television reception, which can be determined by turning the equipment off and on, the user is encouraged to try to correct the interference by one or more of the following measures:

- Reorient or relocate the receiving antenna.
- Increase the separation between the equipment and receiver.
- Connect the equipment into an outlet on a circuit different from that to which the receiver is connected.
- Consult the dealer or an experienced radio/TV technician for help.

Canada

RSS-210 Low Power Device

Operation is subject to the following two conditions: (1) This device may not cause interference, and (2) this device must accept any interference, including interference that may cause undesired operation of the device.

European Union countries, Iceland, Norway, Liechtenstein, Turkey, Swiss

EN300 328 satisfied

Hereby, Nikon-Trimble Co., Ltd., declares the RE type Total station Nikon XS Series are in compliance with RED 2014/53/EU.

The full text of the EU DoC is available at the following internet address: <http://www.nikon-trimble.com/>

RF exposure compliance

- 1) To comply with FCC/IC RF exposure compliance requirements, a separation distance of at least 20 cm must be maintained between the antenna of this device and all persons.
- 2) This transmitter must not be co-located or operating in conjunction with any other antenna or transmitter.

According to Taiwan NCC regulation of Administrative Regulations on Low Power Radio Waves Radiated Devices:

Article 12

Without permission granted by the DGT, any company, enterprise, or user is not allowed to change frequency, enhance transmitting power or alter original characteristic as well as performance to a approved low power radio-frequency devices.

Article 14

The low power radio-frequency devices shall not influence aircraft security and interfere legal communications; If found, the user shall cease operating immediately until no interference is achieved.

The said legal communications means radio communications is operated in compliance with the Telecommunications Act.

The low power radio-frequency devices must be susceptible with the interference from legal communications or ISM radio wave radiated devices.

Safety

In this chapter:

- [Introduction](#)
- [Warnings and Cautions](#)
- [Rechargeable Lithium-ion \(Li-ion\) batteries](#)
- [Laser Safety](#)

Introduction

For your safety, read this instruction manual carefully and thoroughly before using the Nikon XS Series Total Station. Although Nikon products are designed for maximum safety, using them incorrectly or disregarding the instructions can cause personal injury or property damage.

You should also read the documentation for any other equipment that you use with a Nikon XS Series instrument.

Note – Always keep the manual near the instrument for easy reference.

Warnings and Cautions

The following conventions are used to indicate safety instructions:



WARNING – Warnings alert you to situations that could cause death or serious injury.



CAUTION – Cautions alert you to situations that could cause injury or property damage.

Always read and follow the instructions carefully.

Warnings

Before using the instrument, read the following warnings and follow the instructions that they provide:



WARNING – Never look at the sun through the telescope. If you do, you may damage or lose your eyesight.



WARNING – The instruments are not designed to be explosion-proof. Do not use the instrument in coal mines, in areas contaminated with coal dust, or near other flammable substances.



WARNING – Never disassemble, modify, or repair the instrument yourself. If you do, you may receive electric shocks or burns, or the instrument may catch fire. You may also impair the accuracy of the instrument.



WARNING – Use **only** the battery charger and AC adapter that are supplied with the instrument. Do **not** use any other charger or you may cause the battery pack to catch fire or rupture.



WARNING – Do not cover the battery charger and AC adapter while the battery pack is being recharged. The charger must be able to dissipate heat adequately. Coverings such as blankets or clothing can cause the charger to overheat.



WARNING – Avoid recharging the battery pack in humid or dusty places, in direct sunlight, or near heat sources. Do not recharge the battery pack when it is wet. If you do, you may receive electric shocks or burns, or the battery pack may overheat or catch fire.



WARNING – Although the battery pack has an auto-reset circuit breaker, you should take care not to short circuit the contacts. Short circuits can cause the battery pack to catch fire or burn you.



WARNING – Never burn or heat the battery. Doing so may cause the battery to leak or rupture. A leaking or ruptured battery can cause serious injury.



WARNING – Before storing the battery pack or battery charger, cover the contact points with insulation tape. If you do not cover the contact points, the battery pack or charger may short circuit, causing fire, burns, or damage to the instrument.



WARNING – The battery is not itself waterproof. Do not get the battery wet when it is removed from the instrument. If water seeps into the battery, it may cause a fire or burns.

Cautions

Before using the instrument, read the following cautions and follow the instructions that they provide:



CAUTION – Use of controls, adjustments, or performance of procedures other than those specified herein may result in hazardous radiation exposure.



CAUTION – The tops of the tripod ferrules are very sharp. When handling or carrying the tripod, take care to avoid injuring yourself on the ferrules.



CAUTION – Before carrying the tripod or the instrument in the carrying case, check the shoulder strap and its clasp. If the strap is damaged or the clasp is not securely fastened, the carrying case may fall, causing personal injury or instrument damage.



CAUTION – Before setting up the tripod, make sure that no-one's hands or feet are underneath it. When the legs of the tripod are being driven into the ground, they could pierce hands or feet.



CAUTION – After mounting the instrument on the tripod, securely fasten the thumb screws on the tripod legs. If the thumb screws are not securely fastened, the tripod may collapse, causing personal injury or instrument damage.



CAUTION – After mounting the instrument on the tripod, securely fasten the clamp screw on the tripod. If the clamp screw is not securely fastened, the instrument may fall off the tripod, causing personal injury or instrument damage.



CAUTION – Securely fasten the tribrach clamp knob. If the knob is not securely fastened, the tribrach may come loose or fall off when you lift the instrument, causing personal injury or instrument damage.



CAUTION – Do not stack objects on the plastic carrying case, or use it as a stool. The plastic carrying case is unstable and its surface is slippery. Stacking or sitting on the plastic carrying case may cause personal injury or instrument damage.



CAUTION – The system in the instrument may stop functioning in order to avoid any errors in measurement when the instrument detects strong electromagnetic wave(s). If this is the case, turn off the instrument and remove the source of the electromagnetic wave(s). Then turn on the instrument to resume the work.

Rechargeable Lithium-ion (Li-ion) batteries



WARNING – Do not damage the rechargeable Lithium-ion battery. A damaged battery can cause an explosion or fire, and can result in personal injury and/or property damage.

To prevent injury or damage:

- Do not use or charge the battery if it appears to be damaged. Signs of damage include, but are not limited to, discoloration, warping, and leaking battery fluid.
 - Do not expose the battery to fire, high temperature, or direct sunlight.
 - Do not immerse the battery in water.
 - Do not use or store the battery inside a vehicle during hot weather.
 - Do not drop or puncture the battery.
 - Do not open the battery or short-circuit its contacts.
-



WARNING – Avoid contact with the rechargeable Lithium-ion battery if it appears to be leaking. Battery fluid is corrosive, and contact with it can result in personal injury and/or property damage.

To prevent injury or damage:

- If the battery leaks, avoid contact with the battery fluid.
 - If battery fluid gets into your eyes, immediately rinse your eyes with clean water and seek medical attention. Do not rub your eyes!
 - If battery fluid gets onto your skin or clothing, immediately use clean water to wash off the battery fluid.
-



WARNING – Charge and use the rechargeable Lithium-ion battery only in strict accordance with the instructions. Charging or using the battery in unauthorized equipment can cause an explosion or fire, and can result in personal injury and/or equipment damage.

To prevent injury or damage:

- Do not charge or use the battery if it appears to be damaged or leaking.
 - Charge the Lithium-ion battery only in a product that is specified to charge it. Be sure to follow all instructions that are provided with the battery charger.
 - Discontinue charging a battery that gives off extreme heat or a burning odor.
 - Use the battery only in equipment that is specified to use it.
 - Use the battery only for its intended use and according to the instructions in the product documentation.
-

Laser Safety

The Nikon XS Series is a Class 2 laser instrument.

Nikon XS Series is a Class 2 Laser Product in accordance with: IEC60825-1:2014: “Safety of Laser Products”

Precautions: To counteract hazards, it is essential for all users to pay careful attention to the safety precautions and control measures specified in the standard IEC60825-1:2014 within the *hazard distance* *); particularly on to “User’s Guide”.

Note – This product complies with IEC 60825-1:2014 and IEC 60825-1:2007 and 21 CFR 1040.10 and 1040.11 except for deviations pursuant to Laser Notice no. 50, dated June 24, 2007.



WARNING – Only qualified and trained persons should be assigned to install, adjust and operate the laser equipment.



WARNING – Precautions should be taken to ensure that persons do not look directly, with or without an optical instrument, into the beam.



WARNING – Laser beam path should be located well above or below eye level wherever practicable.

Table 1.1 Specifications for laser emission

Laser pointer	
Wave length	630-680 nm
Output power	CW $P_o \leq 1 \text{ mW}$
Disatance meter	
Wave length	850-890 nm
Output power	Pulse $P_o \leq 22 \text{ W}$
Pulse width	< 5 ns
Laser plummet	
Wave length	635 nm
Output power	CW $P_o < 1.0 \text{ mW}$

Table 1.2 Conforming standards

E.U.	IEC60825-1:2014 Laser Pointer: Class 2 Distance Meter: Class 1 Laser plummet: Class 2
USA	FDA21CFR Part 1040 Sec.1040.10 and 1040.11 (except for deviations pursuant to Laser Notice No.50, dated June 24, 2007)



Laser pointer



Laser plummet

(This label is attached when the instrument is laser plummet model)

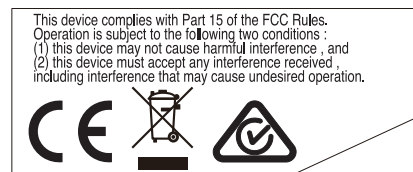

Bluetooth

Class 2 Bluetooth 2.0 EDR+	Frequency band: 2402 MHz to 2480 MHz Maximum output power: 2.5 mW
-----------------------------------	--

Contents

1	Safety	v
	Introduction	vi
	Warnings and Cautions	vi
	Warnings	vi
	Cautions	vii
	Rechargeable Lithium-ion (Li-ion) batteries	viii
	Laser Safety	ix
	Bluetooth	x
1	Introduction	1
	Welcome	2
	Standard Components	3
	Parts of the Instrument	4
	Maintenance	6
2	Preparation	9
	Unpacking and Packing the Instrument	10
	Unpacking	10
	Packing	10
	Charging the Battery Pack	10
	Detaching and Re-Attaching the Battery Pack	14
	Setting Up the Tripod	15
	Centering	15
	Centering using the optical plummet	15
	Centering using the laser plummet	16
	Centering using a plumb bob	17
	Leveling	17
	Sighting and Focusing	18
	Sighting	18
	Auto Focusing	19
	Setting the Measurement Mode and Preparing the Target	19
	Measurement in Reflectorless Mode	20
	Measurement with a Prism	21
	Setting Up the Prism Reflector	22
	Adjusting the height of the tribrach adapter	23
	Changing the direction of the prism	23
	Setting the prism constant	23
	Setting the position of the target plate	24
	Face-1/Face-2 Measurement	24
	External Device Connector	25
3	Getting Started	27
	Turning the Instrument On and Off	28
	Turning on the instrument	28
	Turning off the instrument	28
	Changing Regional Configuration Presets	29
	PIN/PUK Lock	30
	Display and Key Functions	30

Status bar32
LCD backlight, Laser pointer, Beep sound and Contrast adjustment35
[DSP] key36
[MODE] key.37
[COD] key38
[HOT] key38
Bubble indicator40
Laser plummet40
[USR] keys41
[DAT] key.42
List Display42
Inputting Data43
Entering a point name or number43
Entering a code45
Entering values in feet and inches47
Jobs48
Creating a new job48
Measuring Distances.49
Sighting a prism reflector49
Measuring distances.49
Measurement settings50
4 Applications53
HA Reset and Angle Operations54
Setting the horizontal angle to 054
Entering the horizontal angle54
Recording a foresight point after repeat angle measurement54
Face-1/Face-2 measurement55
Horizontal angle hold55
Station Setup56
Setting up a station with known coordinates or azimuth.56
Setting up a station using multiple point resection59
Setting up the station quickly without coordinates61
Determining station elevation62
Checking and resetting the backsight direction62
Two-point resection along a known line64
Use last station.65
Stakeout66
Specifying the stakeout point by angle and distance66
Specifying the stakeout point by coordinates68
DivLine S-O69
RefLine S-O70
Program Key71
Measuring distance and offset values along a specified line71
Measuring distance and offset values on the arc-curve73
Remote distance measurement.75
Measuring remote elevation77
Measuring distance and offset values on the vertical plane78

Measuring distance and offset values on the slope 80
Recording Measurement Data. 81
Recording data from any observation screen 81
Outputting data to the COM port 82
Measuring Offsets 83
Measuring taped offsets 83
Measuring angle offsets 84
Two-prism pole 84
Extending a line by horizontal angle offset 85
Entering a horizontal distance after an angle-only shot 86
Calculating a corner point 86
Measuring circle offsets 88
Extending the slope distance. 89
5 Menu Key. 91
Job Manager 92
Opening an existing job 92
Creating a new job 92
Deleting a job 93
Setting the control job 94
Displaying job Information 94
Importing a job. 94
Exporting a job. 95
Cogo 96
Calculating angle and distance between two coordinates 96
Calculating and manually inputting coordinates 98
Calculating area and perimeter 99
Calculating coordinates from line and offset 101
Calculating coordinates using intersection functions 102
Settings. 106
Angle 106
Distance 107
Coordinate 108
Power saving. 109
Communications 109
Stakeout 110
Unit 110
Recording. 110
Security settings 111
Others settings 111
Data 112
Viewing records 112
Deleting records 115
Editing records. 116
Searching records 118
Entering coordinates 119
Point name list and code list 120
Communication 123

Downloading data	123
Uploading coordinate data	123
Uploading a point name list or code list	125
1sec-Keys	126
[MSR] key settings	126
[DSP] key settings	126
[USR] key settings	127
[S-O] key settings	127
[DAT] key settings	127
Calibration	128
Time	128
Removable Memory (USB Memory).	129
Displaying the external memory files	129
Renaming a job or file on the removable memory	130
Deleting a job of file from the removable memory	130
Copying a job from the removable device	130
Changing the list view of files on the removable memory	131
6 Checking and Adjustment	133
Adjusting the Electronic Level	134
Checking and Adjusting the Circular Level	134
Checking and Adjusting the Optical/Laser Plummet	134
Zero Point Errors of Vertical Scale and Horizontal Angle Corrections	135
Checking	135
Adjusting	135
Auto Focus	137
Adjusting	137
Checking the Instrument Constant	138
Checking the Laser Pointer	139
7 System Diagrams	141
System Components	142
8 Communications	145
Uploading Coordinate Data	146
Settings	146
Record format	146
Uploading Point Lists and Code Lists	148
Settings	148
File format	148
Data example	149
Downloading Data	150
Settings	150
Nikon raw record formats	150
SDR2x and SDR33 record formats	153
Data examples	157
9 Error Messages	161
Cogo	162
Communications	162

Data	163
Job Manager	164
Programs	164
Recording Data	165
Searching	166
Settings.	166
Stakeout	166
Station Setup	167
System Error	168

Introduction

In this chapter:

- [Welcome](#)
- [Standard Components](#)
- [Parts of the Instrument](#)
- [Maintenance](#)

Welcome

Thank you for purchasing this Nikon product.

This instruction manual was written for the users of Nikon XS Series Total Station instruments. Before you operate a Nikon XS Series Total Station, read this manual carefully. In particular, pay attention to the warnings and cautions that appear in the Safety section at the front of the manual. Before you begin, you should also read the maintenance instructions. For more information, see [Maintenance, page 6](#).

Standard Components

- Instrument main body
- Battery pack (x 2)
- Universal charger, power cord, and adapters
- Adjustment pin, Allen wrench
- Objective lens cap
- Rain/dust cover
- Carrying case
- Shoulder strap (x 2)

Parts of the Instrument

Figure 1.1 and Figure 1.2 show the main parts of the Nikon XS Series Total Station.

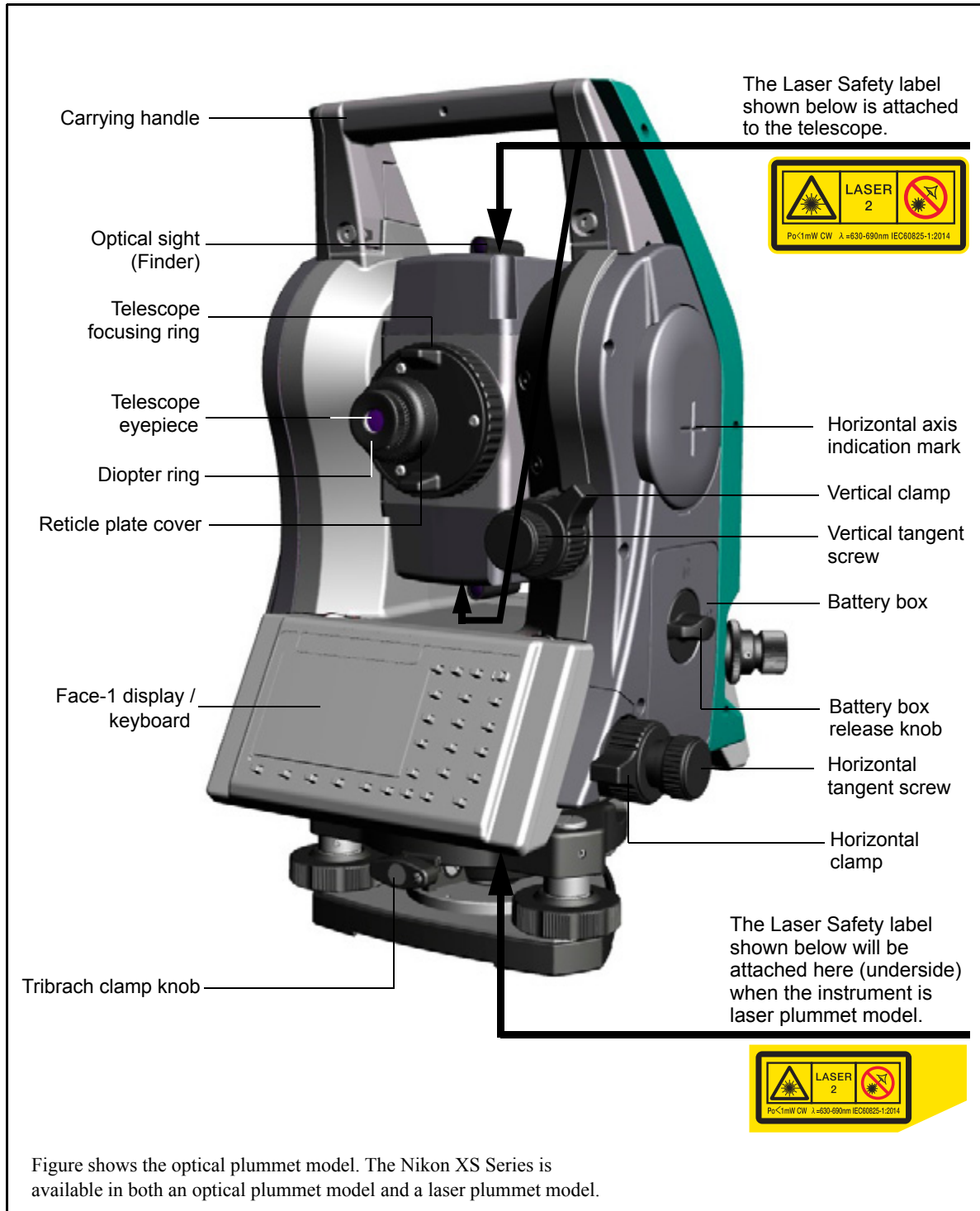

Figure 1.1 Nikon XS Series Total Station – Face-1

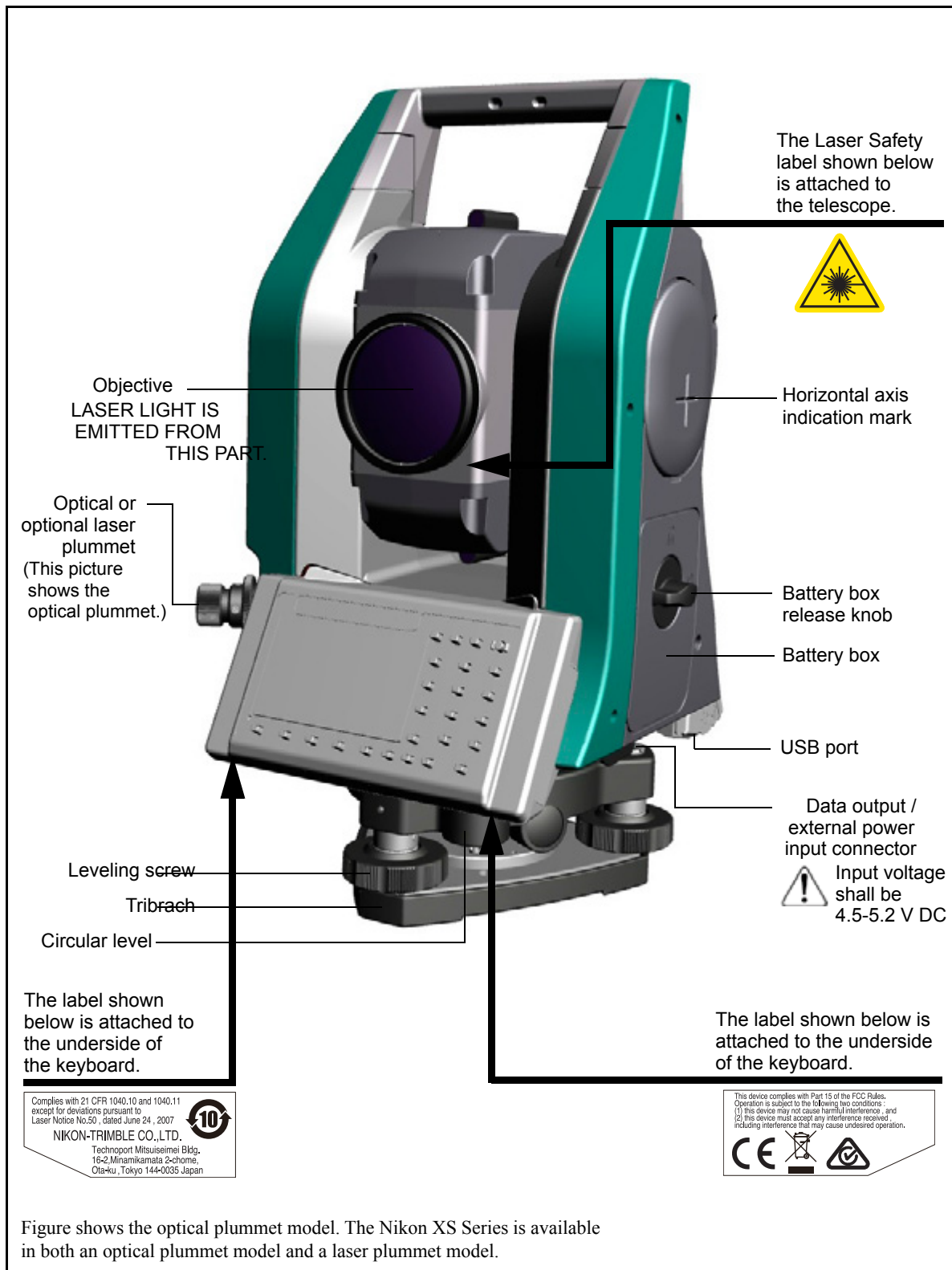

Figure 1.2 Nikon XS Series Total Station – Face-2

Maintenance

Before using the instrument, read and follow the following maintenance instructions:

- Do not leave the instrument in direct sunlight or in a closed vehicle for prolonged periods. Overheating the instrument may reduce its efficiency.
- If the instrument has been used in wet conditions, immediately wipe off any moisture and dry the instrument completely before returning the instrument to the carrying case. The instrument contains sensitive electronic assemblies which have been well protected against dust and moisture. However, if dust or moisture gets into the instrument, severe damage could result.
- Sudden changes in temperature may cloud the lenses and drastically reduce the measurable distance, or cause an electrical system failure. If there has been a sudden change in temperature, leave the instrument in a closed carrying case in a warm location until the temperature of the instrument returns to room temperature.
- Do not store the instrument in hot or humid locations. In particular, you must store the battery pack in a dry location at a temperature of less than 30 °C (86 °F). High temperature or excessive humidity can cause mold to grow on the lenses. It can also cause the electronic assemblies to deteriorate, and so lead to instrument failure.
- Store the battery pack with the battery discharged.
- When storing the instrument in areas subject to extremely low temperatures, leave the carrying case open.
- When adjusting the leveling screws, stay as close as possible to the center of each screw's range. The center is indicated by a line on the screw.
- If the tribrach will not be used for an extended period, lock down the tribrach clamp knob and tighten its safety screw.
- Do not overtighten any of the clamp screws.
- When adjusting the vertical tangent screw and horizontal tangent screw, stay as close as possible to the center of each screw's range. The center is indicated by a line on the screw. For final adjustment of the tangent screws, rotate the screw clockwise.
- Do not use organic solvents (such as ether or paint thinner) to clean the non-metallic parts of the instrument (such as the keyboard) or the painted or printed surfaces. Doing so could result in discoloration of the surface, or in peeling of printed characters. Clean these parts only with a soft cloth or a tissue, lightly moistened with water or a mild detergent.
- To clean the optical lenses, lightly wipe them with a soft cloth or a lens tissue that is moistened with alcohol.

- The reticle plate cover has been correctly mounted. Do not release it or subject it to excessive force to make it watertight.
- Before attaching the battery pack, check that the contact surfaces on the battery and instrument are clean.
- Securely press the cap that covers the data output/external power input connector terminal. The instrument is not watertight if the cap is not attached securely, or when the data output/external power input connector is used.
- The carrying case is designed to be watertight, but you should not leave it exposed to rain for an extended period. If exposure to rain is unavoidable, make sure that the carrying case is placed with the Nikon nameplate facing upward.
- The battery pack contains a Lithium-ion battery. When disposing of the battery pack, follow the laws or rules of your municipal waste system.
- The instrument can be damaged by static electricity from the human body discharged through the data output/external power input connector. Before handling the instrument, touch any other conductive material once to remove static electricity.
- Be careful not to pinch your finger between the telescope and trunnion of the instrument.

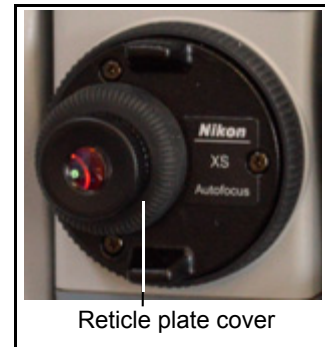

Preparation

In this chapter:

- Unpacking and Packing the Instrument
- Charging the Battery Pack
- Detaching and Re-Attaching the Battery Pack
- Setting Up the Tripod
- Centering
- Leveling
- Sighting and Focusing
- Setting the Measurement Mode and Preparing the Target
- Measurement in Reflectorless Mode
- Measurement with a Prism
- Setting Up the Prism Reflector
- Face-1/Face-2 Measurement
- External Device Connector

Unpacking and Packing the Instrument

Note – Handle the instrument gently to protect it from shocks and excessive vibration.

Unpacking

To unpack the instrument, grip the carrying handle and gently remove the instrument from the carrying case.

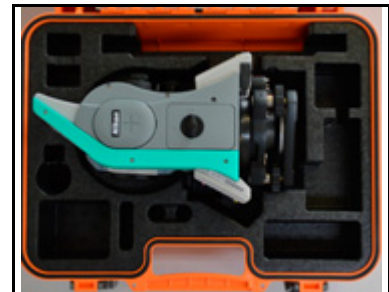

Packing

To pack the instrument back into the carrying case, please refer to the figure on the right.

Charging the Battery Pack

Before charging the battery pack, read the warnings (also listed in the Safety section at the front of this manual) and the following notes.



WARNING – Do not damage the rechargeable Lithium-ion battery. A damaged battery can cause an explosion or fire, and can result in personal injury and/or property damage.

To prevent injury or damage:

- Do not use or charge the battery if it appears to be damaged. Signs of damage include, but are not limited to, discoloration, warping, and leaking battery fluid.
 - Do not expose the battery to fire, high temperature, or direct sunlight.
 - Do not immerse the battery in water.
 - Do not use or store the battery inside a vehicle during hot weather.
 - Do not drop or puncture the battery.
 - Do not open the battery or short-circuit its contacts.
-



WARNING – Avoid contact with the rechargeable Lithium-ion battery if it appears to be leaking. Battery fluid is corrosive, and contact with it can result in personal injury and/or property damage.

To prevent injury or damage:

- If the battery leaks, avoid contact with the battery fluid.
 - If battery fluid gets into your eyes, immediately rinse your eyes with clean water and seek medical attention. Do not rub your eyes!
 - If battery fluid gets onto your skin or clothing, immediately use clean water to wash off the battery fluid.
-



WARNING – Charge and use the rechargeable Lithium-ion battery only in strict accordance with the instructions. Charging or using the battery in unauthorized equipment can cause an explosion or fire, and can result in personal injury and/or equipment damage.

To prevent injury or damage:

- Do not charge or use the battery if it appears to be damaged or leaking.
 - Charge the Lithium-ion battery only in a product that is specified to charge it. Be sure to follow all instructions that are provided with the battery charger.
 - Discontinue charging a battery that gives off extreme heat or a burning odor.
 - Use the battery only in equipment that is specified to use it.
 - Use the battery only for its intended use and according to the instructions in the product documentation.
-



WARNING – To charge the battery pack, use only the battery charger and AC adapter that are supplied with the instrument. Do not use any other charger or you may cause the battery pack to catch fire or rupture. The enclosed battery pack cannot be used with other chargers.



WARNING – Do not cover the battery charger and AC adapter while the battery pack is being recharged. The charger must be able to dissipate heat adequately. Coverings such as blankets or clothing can cause the charger to overheat.



WARNING – Avoid recharging the battery pack in humid or dusty places, in direct sunlight, or near heat sources. Do not recharge the battery pack when it is wet. If you do, you may receive electric shocks or burns, or the battery pack may overheat or catch fire.



WARNING – Although the battery pack has an auto-reset circuit breaker, you should take care not to short circuit the contacts. Short circuits can cause the battery pack to catch fire or burn you.



WARNING – Never burn or heat the battery. Doing so may cause the battery to leak or rupture. A leaking or ruptured battery can cause serious injury.



WARNING – Before storing the battery pack or battery charger, cover the contact points with insulation tape. If you do not cover the contact points, the battery pack or charger may short circuit, causing fire, burns, or damage to the instrument.



WARNING – The battery is not itself waterproof. Do not get the battery wet when it is removed from the instrument. If water seeps into the battery, it may cause a fire or burns.

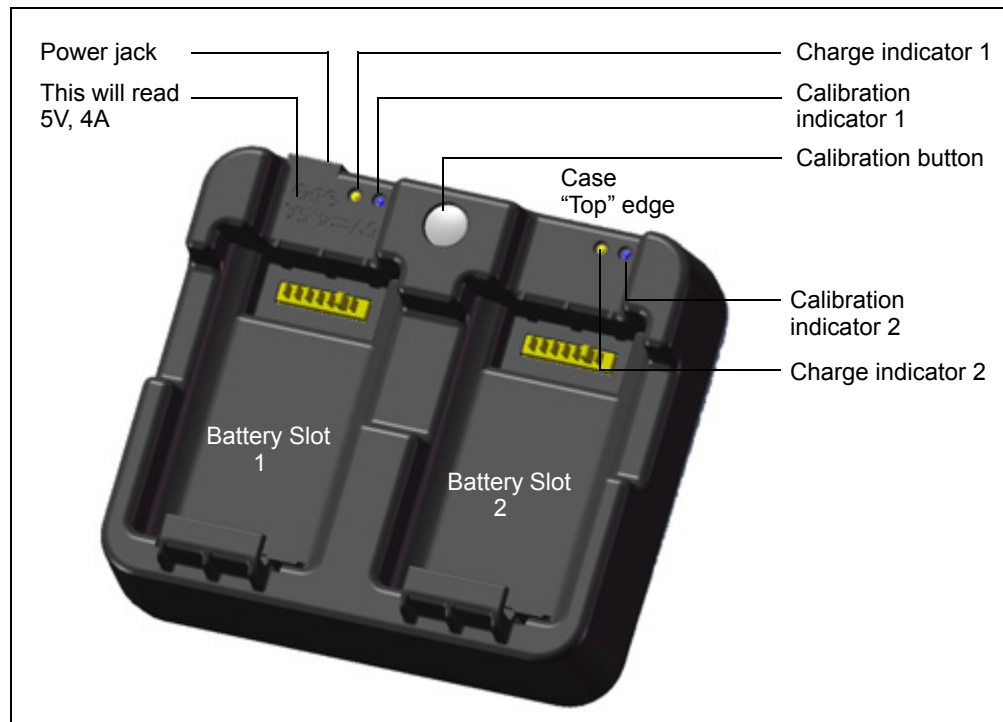

Applying Power

- Plug in the charger to the supplied AC adapter to turn the unit on. The power input must be 5 V with at least 4 A of current capability. Each battery may take up to 2 A while charging.

Charging a battery

- Simply slide a battery into either battery slot to begin charging. The adjacent charge indicator will illuminate yellow when charging is in progress. The charge indicator will change to green when charging is complete.
- Two battery slots are independent of each other. A battery slot can be used regardless of the state of the other battery slot.
- Charging a normally discharged battery may take 3 to 6 hours.
- Charging an exhausted battery which has not been used for several months may take up to 7 hours.
- Li-Ion battery is designed not to be charged when its temperature becomes higher than 40 °C to 45 °C. In such conditions, the charge indicator will blink to warn the battery is too hot to continue charging. Wait for a while and the charging will resume after the battery has cooled down. As a result, note that the charging time will be longer.

- If the charge indicator(s) are blinking and the batteries feel cool, it may indicate a problem with the battery or the charger. If the charge light is still blinking after trying several batteries which are not warm, there is a problem with the unit or the batteries themselves.

Conditioning / calibrating a battery

- Battery calibration is necessary about once every 6 months or more often if desired. Calibration ensures the reported battery charge remaining is accurate.
- Hold down the calibration button on the unit and then insert a battery while holding the calibration button to begin a battery calibration. Only the battery which was inserted while the button was depressed will begin calibration. During a battery calibration the battery will be charged, discharged completely, and then recharged before finishing. Calibration should complete in roughly 22 hours and the charger vents should not be covered during a calibration cycle.
- The blue calibration indicator light(s) will blink slowly (on 1.5 sec, off 2 sec) while a calibration is in progress and the charge light(s) may be on or off during the calibration cycle.
- When a calibration cycle is completed, the calibration light will stop blinking and remain on until the corresponding battery is removed.
- The bottom case temperature may continue to climb up to approximately 43 °C before temperature regulation is enabled to keep the case from getting warmer. As the battery voltage drops, the case will cool down and the automatic temperature limiting will no longer be necessary which minimizes the time it takes to discharge a battery.
- If the case temperature continues to get too hot internally even after temperature regulation is enabled, there is a secondary failsafe which will abort the calibration completely. If an abort occurs, the calibration light(s) will blink rapidly and battery charging will be re-enabled.

Detaching and Re-Attaching the Battery Pack

Detaching the battery pack



CAUTION – Avoid touching the contacts on the battery pack.

1. If the instrument is turned on, press **[PWR]** to turn it off.
2. Turn the battery box release knob counterclockwise, open the battery box cover and remove the battery pack from the battery box.

Inserting the battery pack

Before inserting the battery pack, clear any dust or other foreign particles from the battery contacts.

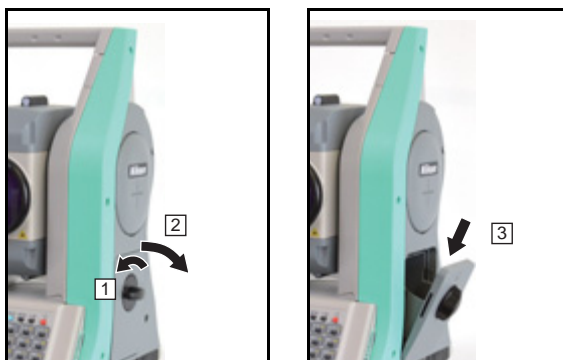

1. Turn the battery box release knob counterclockwise and open the battery box cover.
2. Put the battery pack into the battery box. Insert the battery pack with the connectors bottom first, facing inside.
3. Close the battery box cover and turn the knob clockwise until the secure click sound is heard.



CAUTION – If the battery box cover is not closed, this could adversely affect the watertightness of the instrument.

Setting Up the Tripod



CAUTION – The tops of the tripod ferrules are very sharp. When handling or carrying the tripod, take care to avoid injuring yourself on the ferrules.

1. Open the tripod legs enough to for the instrument to be stable.
2. Locate the tripod directly over the station point. To check the tripod's position, look through the center hole in the tripod head.
3. Firmly press the tripod ferrules into the ground.
4. Level the top surface of the tripod head.
5. Securely fasten the thumb screws on the tripod legs.
6. Place the instrument on the tripod head.
7. Insert the tripod mounting screw into the center hole of the base plate of the instrument.
8. Tighten the tripod mounting screw.

Note – Do not carry the instrument while it is attached to a tripod.

Centering

When you center the instrument, you align its central axis precisely over the station point. To center the instrument, you can either use the laser or optical plummet or a plumb bob.

Centering using the optical plummet

Note – If you require high accuracy, check and adjust the optical plummet before you center the instrument. For detailed instructions, see [Checking and Adjusting the Optical/Laser Plummet, page 134](#).

To center the instrument using the optical plummet:

1. Set up the instrument on the tripod. For detailed instructions, see [Setting Up the Tripod, page 15](#).
2. While looking through the optical plummet, align the reticle with the station point. To do this, turn the leveling screws until the center mark  of the reticle is directly over the image of the station point.
3. While supporting the tripod head with one hand, loosen the tripod leg clamps and adjust the lengths of the legs until the air bubble is in the center of the circular level.
4. Tighten the tripod leg clamps.

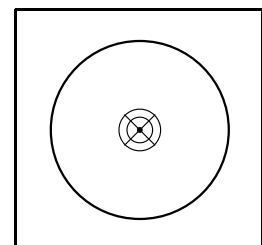

5. Use the electronic level to level the instrument. For detailed instructions, see [Leveling, page 17](#).
6. Look through the optical plummet to check that the image of the station point is still in the center of the reticle mark.
7. If the station point is off center, do one of the following:
 - If the station point is slightly off center, loosen the tripod mounting screw and then center the instrument on the tripod. Use only direct movement to center the instrument. Do not rotate it.

When the instrument is centered, tighten the mounting screw.
 - If the displacement of the station point is major, repeat this procedure from Step 2.

Centering using the laser plummet

Note – Do NOT look into the laser directly.

Note – If you require high accuracy, check and adjust the laser plummet before you center the instrument. For detailed instructions, see [Checking and Adjusting the Optical/Laser Plummet, page 134](#).

1. Set up the instrument on the tripod. For detailed instructions, see [Setting Up the Tripod, page 15](#).
2. Turn on the laser plummet. See [Laser plummet ON/OFF, page 40](#).
3. Align the laser pointer to the station point. To do this, turn the leveling screws until the laser pointer is over the station point.
4. While supporting the tripod head with one hand, loosen the tripod leg clamps and adjust the lengths of the legs until the air bubble is the center of the circular level.
5. Tighten the tripod leg clamps.
6. Use the electronic level to level the instrument. For detailed instructions, see [Leveling, page 17](#).
7. Check the laser pointer is over the station point.
8. If the station point is off center, do one of the following:
 - If the station point is slightly off center, loosen the tripod mounting screw and then center the instrument on the tripod. Use only direct movement to center the instrument. Do not rotate it.
 - When the instrument is centered, tighten the mounting screw.
 - If the displacement of the station point is major, repeat this procedure from Step 2

Centering using a plumb bob

1. Set up the instrument on the tripod. For detailed instructions, see [Setting Up the Tripod, page 15](#).
2. Hang the plumb line on the hook of the tripod mounting screw.
3. Adjust the length of the plumb line so that the tip of the plumb bob is at the height of the station point.
4. Loosen the tripod mounting screw slightly.
5. Using both hands to support the outer side of the tribrach, carefully slide the instrument about on the tripod head until the tip of the plumb bob is positioned over the exact center of the station point.

Note – To confirm that the instrument is precisely aligned, check its position from two directions at right angles to each other.

Leveling

When you level the instrument, you make the vertical axis of the instrument exactly vertical. To level the instrument, use the electronic level. In the leveling work, always set the instrument in face 1 direction (please refer to the Fig.1.1 in page 3).

To level the instrument:

1. Move the bubble into the circle drawn on the circular level and then turn on the power.
2. Rotate the alidade until the bottom edge of the keyboard panel is parallel to the two of the leveling screws (B and C).
3. Use leveling screws B and C to move the bubble into the center of the electronic level.
4. Use leveling screw A to move the bubble into the center of the electronic level.
5. Repeat Step 2 through Step 4 to center the bubble.
6. Rotate the alidade 180°.
7. If the bubble in the electronic level remains centered, the instrument is level. If the bubble moves off center, adjust the electronic level. For detailed instructions, see [Adjusting the Electronic Level, page 134](#).

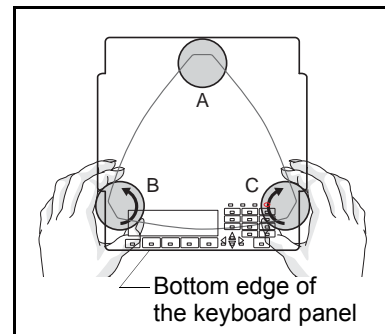

Sighting and Focusing

Sighting

When you sight the instrument, you aim the telescope at the target, bring the target image into focus, and align the image with the center crosshairs of the reticle.

To sight the instrument:

1. Adjust the diopter:
 - a. Aim the telescope at a blank area, such as the sky or a piece of paper.

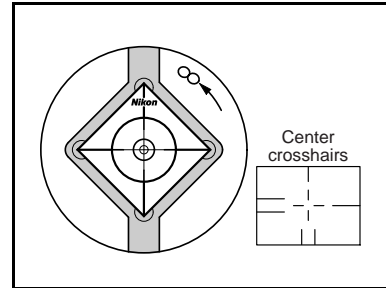

WARNING – Never look at the sun through the telescope. If you do, you may damage or lose your eyesight.

- b. Looking through the eyepiece, rotate the diopter ring until the reticle crosshairs are in sharp focus.
2. Eliminate parallax:
 - a. Aim the telescope at the target image.

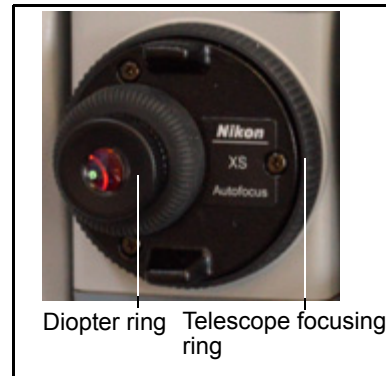

- b. Rotate the focusing ring until the target image is in sharp focus on the reticle crosshairs.
 - c. Move your eye vertically and laterally to check whether the target image moves relative to the reticle crosshairs.

If the target image does not move, there is no parallax.

- d. If the target image does move, rotate the telescope focusing ring. Then repeat from Step c.
3. Rotate the tangent screw:
 - The final turn of the tangent screw should be in a **clockwise** direction, to align the target accurately on the center crosshairs.
 - The focusing lens is driven by a motor when the telescope focusing ring is turned.

Note – To move the focusing lens, you need to power ON the instrument.

Auto Focusing

Use autofocus to focus to a target automatically. First ensure AF is enabled, see [Auto Focus, page 109](#) for autofocus settings, then press **[AF]** key.

The Auto Focusing system focuses the lens using a distance captured by the EDM. At any time the manual focus ring can be used for precise adjustments to the focus.

The Auto Focusing system uses distance taken by EDM to drive the focusing lens to the appropriate position. Therefore, an EDM distance is required, if the instrument is to Auto Focus.

To best obtain the required distance for the EDM, rough sighting by optical sight (Finder) is needed.

The focusing is based on the center of the telescope (cross-hair sighting).

After turning the focusing ring, the instrument will remain in manual focusing mode until the **[AF]** key is next pressed.

Setting the Measurement Mode and Preparing the Target

The Nikon XS Series has two measurement modes: Prism mode (**PRISM**) and Reflectorless mode (**N-PRISM**). These modes can be changed at any time by holding down the **[MSR1]** or **[MSR2]** key for one second. For more information, see [Measurement settings, page 50](#).

To set the measurement mode depending on the target you want to measure, see the following table.

Target	Target setting
Prism, reflector sheet	Prism (Prism mode)
Other (reflective materials)	N-Prism (Reflectorless mode)

In some cases, you can measure another target that is not appropriate to the set measurement mode.

Note – The Nikon XS Series is Laser Class 1 in the measurement function, and Laser Class 2 in the Laser pointer function.

Don't sight the Prism when the Laser Pointer is on.

Measurement in Reflectorless Mode

The intensity of the reflection from the target determines the distance the Nikon XS Series can measure in this mode. The color and condition of the target surface also affect the measurable distance, even if the targeted objects are the same. Some less-reflective targets may not be measured.

The following table describes some examples of targets and approximate measureable distances.

Target	You can measure approximately...
Traffic signs, reflectors	800 meters (2624 feet)
Paper (white), veneer (new)	450 meters (1476 feet)
Wall (brightly painted), brick	150 to 300 meters (492 to 984 feet)

Measurable distances may be shorter or measurement intervals may be longer in the following cases:

- the angle of the laser against the target is small
- the surface of the target is wet

In direct sunlight, the measurable distance may be shorter. In this case, try to throw a shadow on the target.

Targets with completely flat surfaces, such as mirrors, cannot be measured unless the beam and the target are perpendicular to each other.

Make sure there are no obstacles between the instrument and the target when taking measurements. When you need to take measurements across a road or a place where vehicles or other objects are frequently moving, take several measurements to a target for the best result.

Measurement with a Prism

Do not use a prism with scratches, a dirty surface, or a chipped center. Prisms with thin edges are recommended.

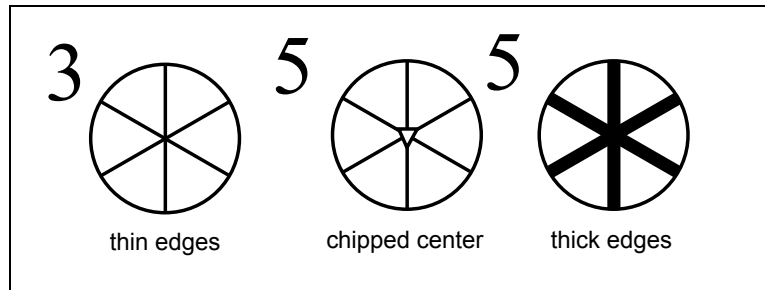

As the Nikon XS Series are extremely sensitive, multiple reflections on the prism surface can sometimes cause a significant loss in accuracy.

To maintain the accuracy of your measurements:

- When measuring a short distance, incline the prism slightly so that the EDM can ignore unnecessary reflections on the prism surface, as shown below.

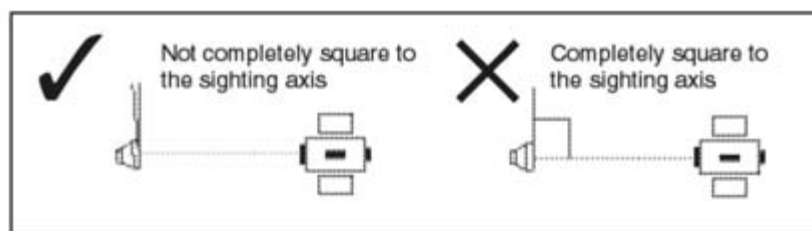

Hold the prism securely in place and do not move while taking measurements.

In Prism mode, in order to avoid false measurements on objects other than the prism or reflector-sheet, targets that are less reflective than the prism or reflector sheet are not measured. Even if measurement is started, measured values are not displayed. To measure less reflective objects, use the N-prism (reflectorless) mode

Setting Up the Prism Reflector

1. Assemble the prism reflector as shown below.

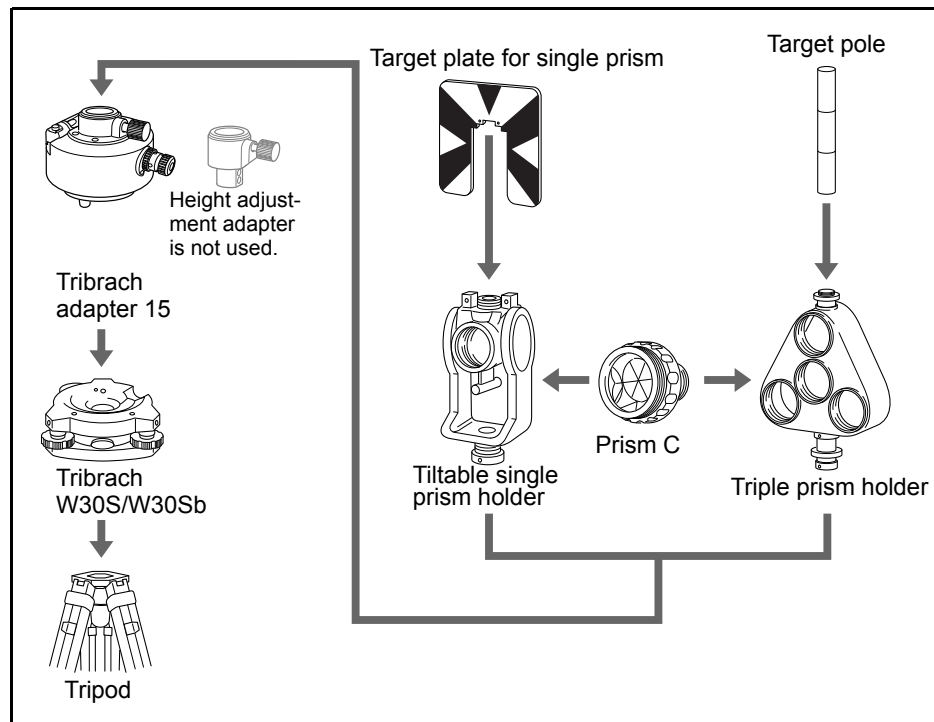

2. Adjust the height of the tribrach adaptor (see [page 23](#)).
3. If necessary, change the direction of the prism (see [page 23](#)).
4. Set the prism constant (see [page 23](#)).
5. If you are using a single prism holder, set the position of the target plate (see [page 24](#)).

Detailed instructions for Step 2 through Step 5 are provided on the following pages.

Note – The instrument must be used with the Tribrach W30S or W30Sb.

Adjusting the height of the tribrach adapter

The tribrach adapter has a height adjustment adapter. To use the prism reflector with the instrument, remove the height adjustment adapter as shown in the Figure below.

The height adjustment adapter will be used with other Nikon Total Stations, except for Nivo Series, XS Series and XF Series.

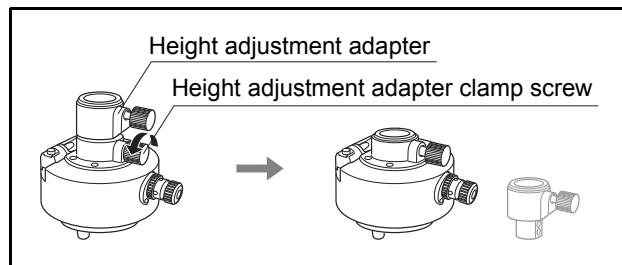

Changing the direction of the prism

The prism mounted on the tribrach adapter can be rotated to face in any direction.

To change the direction of the prism:

1. Release the rotation clamp. To do this, turn the clamp lever counterclockwise.
2. Turn the upper plate of the tribrach adapter until the prism is facing in the required direction.
3. Fasten the rotation clamp. To do this, turn the clamp lever clockwise.

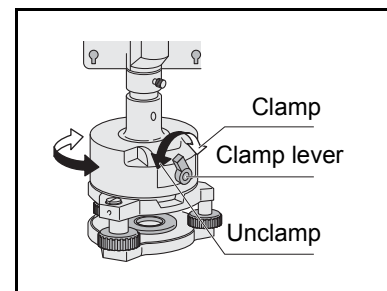

Setting the prism constant

1. Attach the prism to the single prism holder or triple prism holder.



Tip – To use a triple prism holder as a single prism holder, attach the prism to the center thread of the prism holder.

2. Set the prism constant. To do this, hold down **[MSR1]** or **[MSR2]** for one second. For more information, see [Measurement settings, page 50](#).

Note – The prism constant of a Nikon prism is always 0, whether it is attached to a single prism holder or a triple prism holder.

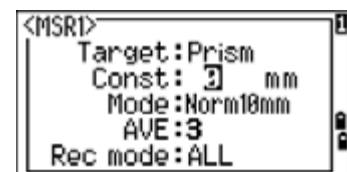

If your prism constant is not 0 mm, then directly enter the prism constant value in the *Const* field. For example, if your prism constant is 30 mm, enter 30mm in the *Const* field on the instrument.



Tip – When you use the prism at a short distance, set the prism at a slight angle to the sighting axis, rather than completely square.

Setting the position of the target plate

If using a single prism, make sure that the target plate is aligned with the tribrach adapter and the prism.

To set the position of the target plate:

1. Use the two set screws supplied to attach the target plate to the single prism holder.
2. Move the target plate within the screw holes until the apex of the wedge pattern is aligned with the vertical axis of the prism and the tribrach adapter.

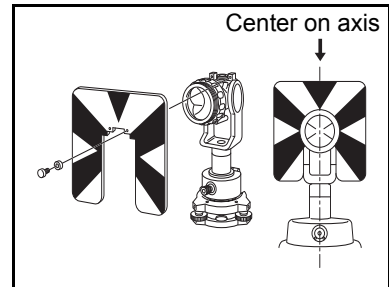

Face-1/Face-2 Measurement

You can take a measurement from either face of the instrument. To change the face, rotate the instrument 180° on its base, and rotate the telescope 180° within the standard.

By averaging the Face-1 and Face-2 measurement values, you can cancel out most constant mechanical errors. Some errors, such as vertical axis error, cannot be cancelled out by averaging Face-1 and Face-2 measurements.



CAUTION – When rotating the telescope, take care not to catch your finger in the gap between the instrument's standard and the telescope.

A Face-1 measurement is made with the vertical circle positioned to the left of the telescope eyepiece. A Face-2 measurement is made with the vertical circle positioned to the right of the telescope eyepiece.

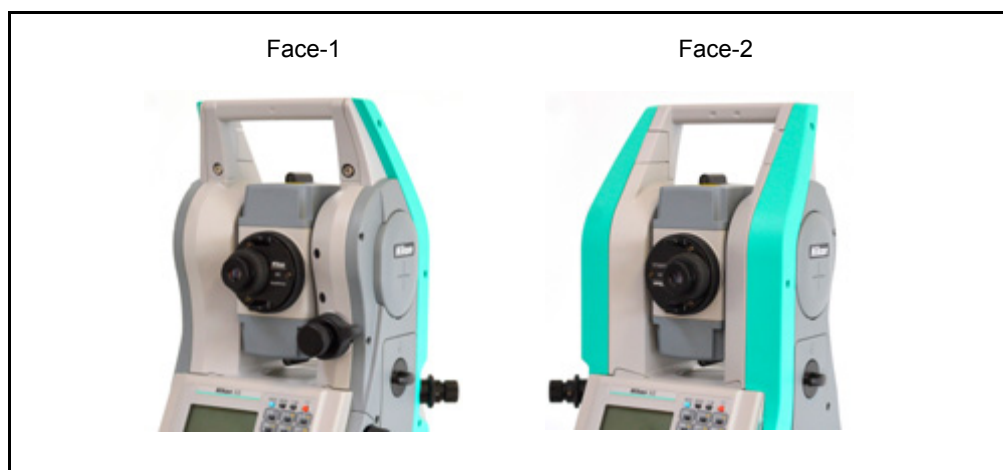

External Device Connector

This connector can be used to connect to an external power source or to communicate with an external device.

Before using the external device connector, make sure that the external device meets the specifications below.

Input voltage	4.5 V to 5.2 V DC
System	RS-232C
Signal level	±9 V standard
Maximum baud rate	38400 bps asynchronous
Compatible male connector	Hirose HR10A-7P-6P or HR10-7P-6P



CAUTION – Except for the connection shown in Figure 7.1 on [page 142](#), use of this connector is at your own risk.



CAUTION – Use only the male connectors specified above. Using other connectors will damage the instrument.

The external device connector is a Hirose HR 10A-7R-6S female connector. The pinouts for connecting it to an external device connector are shown below:

Pin	Signal	Description
1	RXD	Receive data (Input)
2	TXD	Send data (Output)
3	NC	No connection
4	V	Power
5	GND	Ground
6	NC	No connection

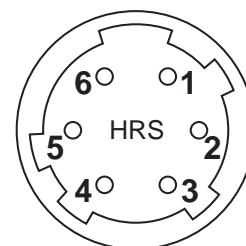

CAUTION – Use only the pin connections shown above. Using other connections will damage the instrument.



CAUTION – The Nikon XS and XF Series Total Stations have different pin assignment from other models of Nikon total station.

To connect to an external power source, supply power to Pin 4 (power terminal) and Pin 5 (ground terminal) on the instrument. The instrument will use the external power source even if the internal battery packs are attached.



CAUTION – Make sure that the power supplied is within the rated input range (4.5 V to 5.2 V DC, 1 A maximum). Power supplied outside this range will damage the instrument.

To communicate with an external device, connect the RS-232C signal from the external device to Pin 1 (input terminal) and to Pin 2 (output terminal) on the instrument.

Cap the data output/external power input connector securely while not in use. The instrument is not watertight if the cap is not attached or not attached securely, and when the data output/external power input connector is in use.

The instrument can be damaged by static electricity from the human body discharged through the data output/external power input connector. Before handling the instrument, touch any other conductive material once to remove static electricity.

Getting Started

In this chapter:

- [Turning the Instrument On and Off](#)
- [Changing Regional Configuration Presets](#)
- [PIN/PUK Lock](#)
- [Display and Key Functions](#)
- [List Display](#)
- [Inputting Data](#)
- [Jobs](#)
- [Measuring Distances](#)

Turning the Instrument On and Off

Turning on the instrument

- To turn on the instrument, press **[PWR]**. The start-up screen appears. It shows the model name, current temperature, pressure, date, and time.

The display automatically changes to the electronic level after 2 seconds.



If you have entered your name or your company's name in the Owner's detail field, the text from this field appears on the start-up screen. To set the Owner's detail field, go to **MENU > Settings > Others**. For more information, see [page 112](#).

Turning off the instrument

To enter the power-off process, press **[PWR]** and **[ENT]**.

Then do one of the following:

Press ...	to ...
[ENT] again	turn off the instrument
the Reset softkey	reboot the program and re-start the instrument
the Sleep softkey	put the instrument into power-saving mode
[ESC]	cancel the power-off process and return to the previous screen

If you press the **Reset** softkey, the software is rebooted and the Basic Measurement Screen (BMS) appears without an open job.

Sleep mode

If you press the **Sleep** softkey in the Press **[ENT]** → OFF screen, or enable the Power Save setting (see [Power saving, page 109](#)), the instrument goes into sleep mode.

When the instrument is in sleep mode, it wakes up if any of the following occurs:

- You press a key
- The instrument receives a remote control command
- You rotate the alidade
- You tilt the telescope

Changing Regional Configuration Presets

To provide easier configuration for common regional settings, you can quickly configure the Nikon total station to a pre-set combination of default regional settings. The Regional Configuration screen appears only after the language configuration is complete, the instrument has rebooted.

1. Follow the steps in [Language, page 112](#).

Once the instrument rebooted, the Regional Configuration screen appears.



2. Press \uparrow or \downarrow to highlight the required regional settings and then press ENT .
3. If you do not want to change the current settings, press ESC and quit. The instrument will continue to use the last configured settings that were configured.

The settings affected by the Regional Configuration screen are:

Category	Setting	Europe	International	United States
Angle	VA zero	Zenith	Zenith	Zenith
	Resolution	1"(See note)	1"(See note)	1"(See note)
	HA	Azimuth	Azimuth	Azimuth
Distance	Scale	1.000000	1.000000	1.000000
	T-P corr.	On	On	On
	Sea Level	Off	Off	Off
	C&R corr.	0.132	0.132	0.132
Coordinates	Order	ENZ	ENZ	NEZ
	Label	ENZ	ENZ	NEZ
	AZ zero	North	North	North
Power Save	Main Unit	Off	Off	Off
	EDM Unit	Off	Off	Off
	Auto Focus	Sig+Key	Sig+Key	Sig+Key
	Sleep	5 minutes	5 minutes	5 minutes
Communication	Ext. Comm	Nikon	Nikon	Nikon
	Baud	4800	4800	4800
	Length	8	8	8
	Parity	None	None	None
	Stop bit	1	1	1
Stakeout	Add PT	1000	1000	1000
Units	Angle	GON	DEG	DEG
	Distance	meters	meters	US-ft
	Temp	°C	°C	°F
	Press	mm Hg	mm Hg	In Hg
Rec	Store DB	RAW&XYZ	RAW&XYZ	RAW&XYZ

Category	Setting	Europe	International	United States
	Data Rec	Internal	Internal	Internal
Others	XYZ disp	Fast	Fast	Fast
	2nd Unit	None	None	None
	Split ST	No	No	No
	CD Input	<ABC>	<ABC>	<ABC>
	Signal Beep	Off	Off	Off
	Owner's Detail	Blank	Blank	Blank

The default regional configuration pre-set is “United States” settings. For more information, see [Settings, page 106](#).

PIN/PUK Lock

If a PIN/PUK security code are activated by the user, a PIN Code enter screen appears. Enter the PIN Code.



If the wrong code is entered more than 10 times, the instrument will be locked and the PUK needs to be entered. See [Security settings, page 111](#).



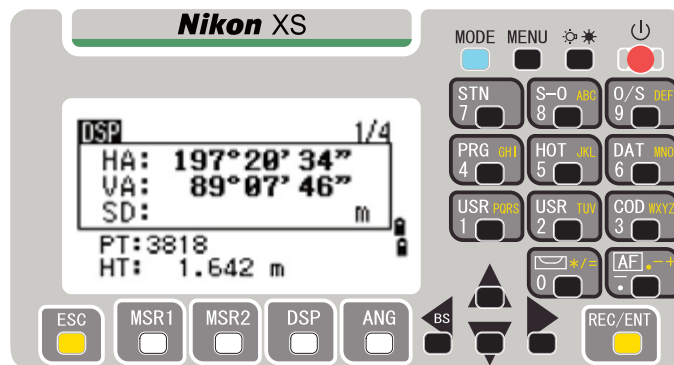









Display and Key Functions

The following figure shows the keys on the Nikon XS Series instrument keyboard and the LCD display.

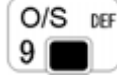

The functions of the instrument keys are as follows.

Key	Function	Details
	Turns the instrument on or off.	page 28
	(Illumination key) Provides access to the switch window. Turns on/off the LCD backlight if held down for one second.	page 35

Key	Function	Details
	Displays the MENU screen.	page 91
	Changes the key input mode between alphanumeric and numeric if pressed when you are in a PT or CD field. Activates Qcode mode if pressed when you are In the Basic Measurement Screen (BMS).	page 37
	Records measured data, moves on to the next screen, or confirms and accepts the entered data in input mode. You have the option to record the measurement as a CP record instead of an SS record, if you hold this key down for one second in the Basic Measurement Screen (BMS). The instrument outputs the current measurement data (PT, HA, VA, and SD) on the COM port if you press this key in the BMS or in a Stakeout observation screen. (The Data Rec settings must be set to COM.)	page 81
	Returns to the previous screen. In numeric or alphanumeric mode, deletes input.	
	Starts distance measurement, using the measure mode settings for the MSR1 key. Displays measurement mode settings, if held down for one second.	page 49
	Starts distance measurement, using the measure mode settings for the MSR2 key. Displays measurement mode settings, if held down for one second.	page 49
	Moves to the next available display screen. Changes the fields that appear on the DSP1, DSP2, and DSP3 screens, if held down for one second.	page 51
	Displays the Angle menu.	page 54
	Displays the Station Setup menu. In numeric mode, enters 7. In alphanumeric mode, enters 7.	page 56
	Displays the Stakeout menu. Shows stakeout settings, if held down for one second. In numeric mode, enters 8. In alphanumeric mode, enters A, B, C, or 8.	page 66
	Displays the Offset Point Measurement menu. In numeric mode, enters 9. In alphanumeric mode, enters D, E, F, or 9.	page 83
	Displays the Programs menu, which contains additional measuring programs. In numeric mode, enters 4. In alphanumeric mode, enters G, H, I, or 4.	page 71

Key	Function	Details
	Displays the (HOT) menu, which includes Height of Target, Temp-Press, Target, Note recording, and Default PT settings. In numeric mode, enters 5. In alphanumeric mode, enters J, K, L, or 5.	page 38
	Displays RAW, XYZ, or STN data, depending on your setting. In numeric mode, enters 6. In alphanumeric mode, enters M, N, O, or 6.	page 42
	Executes the function that is assigned to the USR1 key. In numeric mode, enters 1. In alphanumeric mode, enters P, Q, R, S, or 1.	page 41
	Executes the function that is assigned to the USR2 key. In numeric mode, enters 2. In alphanumeric mode, enters T, U, V, or 2.	
	Opens a window where you can enter a code. The default code value is the last code entered. In numeric mode, enters 3. In alphanumeric mode, enters W, X, Y, Z, or 3.	page 38
	Start Auto Focus with measured distance by EDM. In numeric mode, enters – (minus). In alphanumeric mode, enters . (period), – (minus), or + (plus). Displays the Power save menu, if held down for one second. <i>Note that Auto Focusing function must be enabled in the settings.</i>	page 109
	Displays the Bubble indicator. In numeric mode, enters 0. In alphanumeric mode, enters *, /, =, (a space), or 0.	page 40

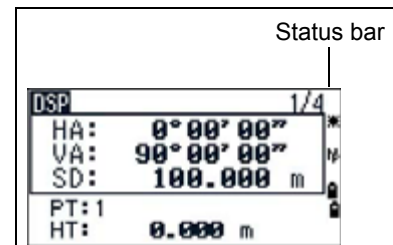

Status bar

The status bar appears on the right side of every screen. It contains icons that indicate the status of various system functions.



Input mode indicator

The Input mode indicator only appears when you are entering points or coordinates. It shows the data input mode:

-  Input mode is numeric. Press a key on the number pad to enter the number printed on the key.
-  Input mode is alphabetic. Press a key on the number pad to enter the first letter printed beside the key. Press the key repeatedly to cycle through all the letters assigned to that key.
For example, to enter the letter O in alphabetic mode, press  three times.

Laser pointer indicator

The icon appears while turning on the laser pointer. When the icon is displayed on the screen, the emitting power is laser class 2.

-  Laser pointer ON.
- (None) Laser pointer OFF.

EDM measurement status

When you are taking measurements, the EDM measurement status shows the mode that is being used.

When you display observation data, the EDM measurement status shows the mode that was used when the data was collected.

-  Reflectorless mode

Communication port status

Bluetooth enabled icon shows the Bluetooth is selected for the Port setting in the Communication menu. (See [Communications](#), page 109.)

-  Bluetooth enabled

Battery indicator

Shows each voltage level of the right and left internal batteries individually. When the external battery is connected with the instrument, its voltage is shown.

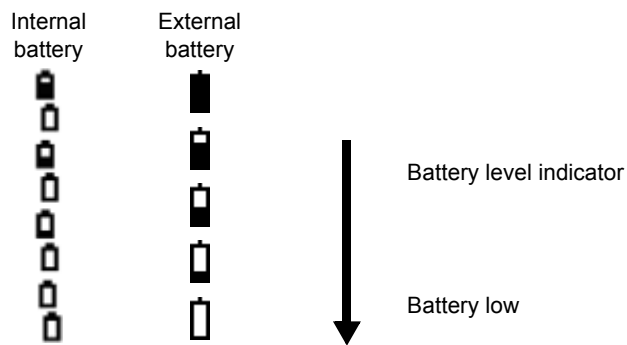
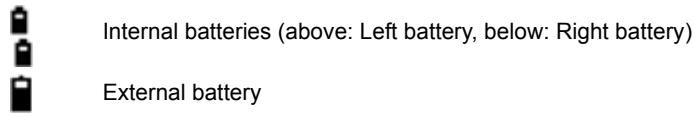

If the battery level becomes critically low, the following message appears:

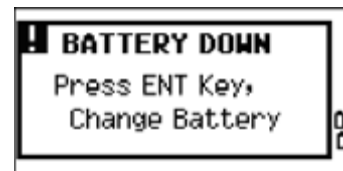

LCD backlight, Laser pointer, Beep sound and Contrast adjustment

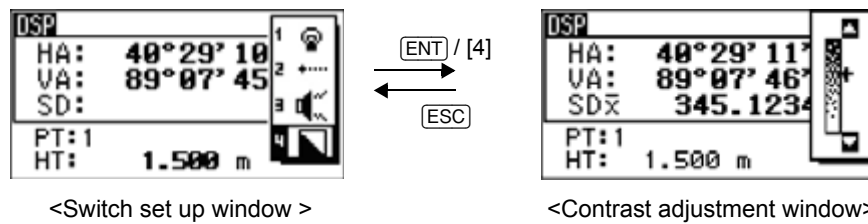

To turn on/off the 1. LCD backlight, 2. laser pointer or 3. beep sound, and to do the 4. contrast adjustment, press the illumination key and open the switch set up window shown above.

Holding down the illumination key for one second also turns on/off the LCD backlight.

- To turn on/off each function, press [ENT] when the option 1, 2, 3 or 4 is selected or directly press [1], [2], [3] or [4] numeric key.
- Press [▲] or [▼] to move the cursor up and down.
- In the contrast adjustment window, use [▲] or [▼] to adjust the contrast.

To close the window, press [ESC].

1. LCD backlight

 LCD backlight is OFF

 LCD backlight is ON

2. Laser pointer

 Laser pointer is OFF

 Laser pointer is ON

3. Sound

 Sound is OFF

 Sound is ON

DSP key

Use the key to change the current display screen or to change display settings.

Switching between display screens

When several display screens are available, the DSP indicator appears at the top left of the screen, and the screen indicator (for example, 1/4) appears at the top right.

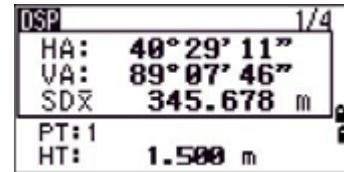

To move to the next available screen, press **DSP**.

For example, if the DSP2 screen is currently displayed, press **DSP** to move to the DSP3 screen. The screen indicator changes from 2/4 to 3/4.

When the secondary distance unit is set, an additional screen is available. It shows the HD, VD, and SD values. For information on setting the secondary distance unit, see [page 111](#).

The smallest unit of display for distances measured in feet-and-inches is 1/16 in. Smaller units are impractical in the field. When the actual value is greater than 9999'11"15/16, the ">" symbol is shown. If the actual distance is less than -9999'11"15/16, the "▶" (solid triangle) symbol is shown. This does not affect calculations. The precise value is used internally in all cases.

Customizing items in the Basic Measurement Screen (BMS)

To customize the items that are displayed on the DSP1, DSP2, and DSP3 screens:

1. Hold down **DSP** for one second.
2. Use the arrow keys **↑**, **↓**, **←**, and **→** to highlight the item that you want to change.
3. Use the **+** and **-** softkeys to scroll through the list of items that can be displayed for this item.

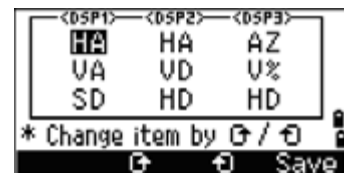

The items that you can choose from are HA, AZ, HL, VA, V%, SD, VD, HD, Z, and (none).

4. To save your changes, press the **Save** softkey. Alternatively, highlight the last item for DSP3 and press **ENT**. The DSP screens show the items you have selected.

Except for the (none) item, you cannot display the same item on more than one line of the same screen.

The items displayed in the DSP1, DSP2, DSP3, and DSP4 screens are also used in the corresponding Stakeout screens (SO2, SO3, SO4, and SO5).

You can also customize the displayed items in Stakeout.

Header characters

The following header characters can be used in DSP screens:

- A colon (:) indicates that tilt correction is applied to the value.
- A hash symbol (#) indicates that tilt correction is off.
- An underscore () under the tilt correction character indicates that Sea Level Correction or Scale factor is applied.

MODE key

Use the **MODE** key to change the keyboard mode for the current screen.

Changing input mode while entering points or codes

When the cursor is in a point (*PT*) or code (*CD*) field, press **MODE** to change the input mode between alphanumeric (A) and numeric (1).

The input mode indicator in the status bar changes to show the current input mode.

When the cursor is in a height (*HT*) field, only numeric input mode is available. Pressing **MODE** has no effect when the cursor is in a *HT* field.

Quick code measurement mode

1. To activate Quick code measurement mode, press **MODE** in the BMS.

The *PT* field shows the default point name.

2. Press any numeric key (0 through 9) to start measuring and recording points.

A list of the numeric keys and their assigned feature codes appears on the right side of the screen.

For example, when you press 6, the code assigned to 6 is selected, and the instrument starts a measurement.

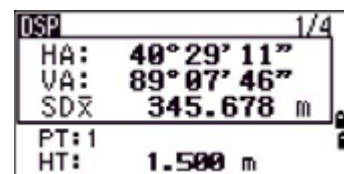

3. If you have set the record mode to Confirm (see [Measurement settings, page 50](#)), the Record PT screen appears after each measurement.

Do one of the following:

- To record the point, press **ENT**.
- To return to the BMS, press **ESC**.

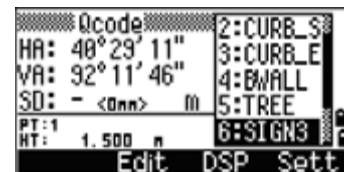

To assign a new feature code to a numeric key, press **▲** or **▼** to highlight the code that you want to change. Then press the **Edit** softkey.

You can use the **DSP** softkey to change the values shown in the measurement box, in the same way as you use the **DSP** key in the Basic Measurement Screen (BMS).

4. To return to the BMS from the Qcode screen, press **MODE** or **ESC**.

[COD] key

In the BMS, press [COD] to change the default feature code that will appear in the CD field when you record a point.

Setting the default code

When you press [COD] in the BMS, a window for entering the feature code appears.

You can use the **List** and **Stack** softkeys to enter the code.

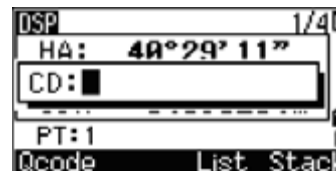
**Qcode observations**

To enter the Quick code observation routine, press the **Qcode** softkey.

In this function, you can use the ten numeric keys to both select a feature code and shoot a point.

To change the measurement mode for the Quick code observation, press the **Sett** softkey.

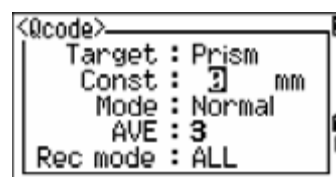

In Quick code measurement, the Rec mode can only be set to Confirm or ALL.

[HOT] key

The HOT key menu is available on any observation screen. To display the HOT key menu, press [HOT].

Changing the height of the target

To change the height of the target, press [HOT] to display the HOT menu. Then either press [1] or select **HT** and press [ENT].

Enter the height of the target, or press the **Stack** softkey to display the HT stack. The HT stack stores the last 20 HT values entered.

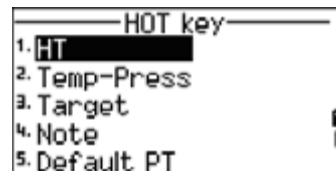
**Setting the temperature and pressure**

To set the current temperature and pressure, press [HOT] to display the HOT menu. Then either press [2] or select **TEMP-PRESS** and press [ENT]. Enter the ambient temperature and pressure. The ppm value is updated automatically.

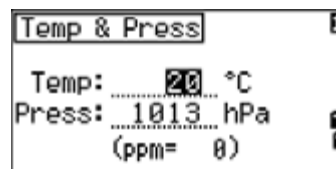

Selecting the target set

A target set specifies settings for the target type, the prism constant, and height of target. When you change the selected target set, all three settings are changed. You can use this function to quickly switch between two types of target, such as a reflector sheet and a prism. You can prepare up to five target sets.

1. Prism	0	-
2. N-Pri	0	-
3. Prism	30	4.208
4. Prism	-18	1.250
5. N-Pri	0	1.010

Press **[HOT]** to display the HOT menu. Then either press **[3]**, or select **Target** and press **[ENT]**. A list of the five target sets appears. To select a target set, either press the corresponding numeric key (**[1]** through **[5]**), or use **[^]** or **[v]** to highlight the target set in the list and press **[ENT]**.

To change the settings defined in a target set, highlight the target set in the list. Then press the **Edit** softkey.

Type	Prism/N-Prism
Const	-999 to 999 mm
HT	-9.990 to 99.990 m

HT can be left blank in the target set. If you leave it blank, the current HT value is always applied to the measurement.

When a target set is selected, the Type and Const values are copied to both **[MSR1]** and **[MSR2]** settings, and to the measurements in Qcode. If you have specified a value for HT, this value is also copied to the current HT.

Entering a field note

To enter a field note, press **[HOT]** to display the HOT menu. Then either press **[4]**, or select **Note** and press **[ENT]**.

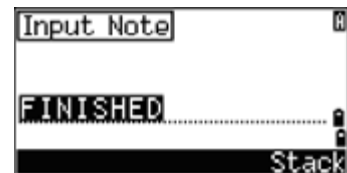

This function can be used at any time on any observation screen.

Each note can be up to 50 characters.

The note is stored as a CO record in the raw data.

To display a list of previously used notes, press the **Stack** softkey. The stack stores the last 20 notes.

Use **[^]** or **[v]** to highlight a note in the list. Then press **[ENT]** to select the note.

Setting the default point name

To change the default point name, press **[HOT]** to display the HOT menu. Then press **[5]**, or select **Default PT** and press **[ENT]**.



This function is available from any observation screen.

Modify the default point name for the next record.

Press **[ENT]** to confirm the new default point name. The new point name is appears as the default PT name on the input screen.

Bubble indicator

The bubble indicator is automatically displayed if the instrument goes out of level while the compensators are turned on, and also appears after the start up screen.

To display the bubble indicator in an observation screen, press **[☰]**.

The Nikon XS Series has two-axis level compensation. To turn the leveling compensators on or off, press **[<]** or **[>]**. When the leveling compensators are turned off, the text OFF appears on the screen.

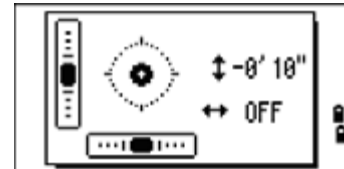

If the instrument is more than $\pm 3'30''$ out of level, the text OVER appears on the screen.

To return to the observation screen, press **[ESC]** or **[ENT]**.

Laser plummet

Laser plummet ON/OFF

Press **[* ON]** to enable the laser plummet.

Press **[ESC]** to close the bubble indicator window.

Press **[↓ OFF]** to disable the laser plummet.

Press **[Lumi.]** to open the luminance adjustment window.

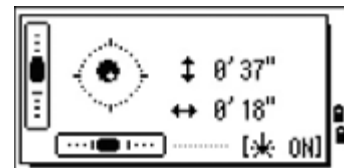

Press **[ESC]** to disable the laser plummet and close the bubble indicator window.

Laser luminance adjustment

Laser luminance can be set to 4 levels.

Press **[Max.]** to increase the luminance of the laser plummet.

Press **[Min.]** to decrease the luminance of the laser plummet.

Press **[ESC]** / **[ENT]** to return to the bubble indicator window.

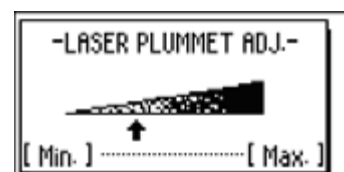

The current setting of leveling compensators is indicated by header characters (., #, ., and #) after field labels (such as HA, VA, SD, and HD) in observation screens. For more information, see [Header characters, page 36](#).

USR keys

If you use a function frequently in the field, you can assign it to the **USR1** or **USR2** key. Whenever you press a **USR** key, the function that is assigned to that key is activated directly.

The following functions can be assigned to the **USR** keys:

- Input HT
- BS Check
- Base XYZ
- Default PT
- Select Target
- Input Temp-Press
- Input Note
- The following menus, or a single function from one of these menus:
 - Cogo
 - O/S
 - PRG

By default, Input HT is assigned to **USR1**, and no function is assigned to **USR2**.

Hold down the **USR** key for one second to display the list of functions that can be assigned to the key. The currently assigned function is indicated by an asterisk (*) beside the function name.

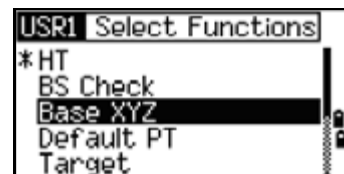

To change the function that assigned to the key, press **▲** or **▼** to highlight the function. Then press **ENT**.

If an item on the list has an arrow (→) beside it, this item is a menu. If you highlight a menu item and then press **ENT**, a sub-menu appears.

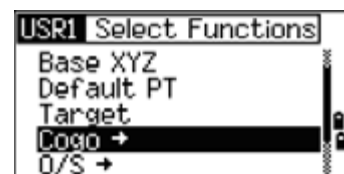

The first item on the sub-menu ends with the text **[MENU]**. If you select this item, the whole menu is assigned to the **USR** key.

To assign a specific function from the sub-menu, press **▲** or **▼** to highlight the function. Then press **ENT**.



Once you have assigned a function to a **[USR]** key, it is called directly whenever you press that **[USR]** key in the BMS.

To change the type of data that is assigned to the **[USR]** keys in MENU > 1sec-Keys > [USR]. For more information, see [USR] [key settings, page 127](#).

[DAT] key

Use the **[DAT]** key to quickly access data in the current job from observation screens.

When you press **[DAT]** in the BMS or in observation screens in functions such as Stakeout, 2Pt RefLine, and Arc RefLine, the assigned data in the current job appears.



Hold down **[DAT]** for one second in the BMS or an observation screen to display the *Select Format* screen. Use this screen to change the type of data that is assigned to **[DAT]**. Press **[1]** or select **DAT [MENU]** to display the Data menu whenever you press **[DAT]**.

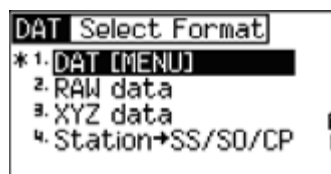

When you select an option from this screen, the change is applied immediately, and the selected data type appears.

Press **[ESC]** to return to the previous observation screen.

To change the type of data that is assigned to **[DAT]**, go to MENU > 1sec-Keys > [DAT]. For more information, see [DAT] [key settings, page 127](#).

List Display

Available jobs or data appear in a list display when you do any of the following:

- view or edit data (MENU > Data)
- open the code list, point list, or Job Manager (MENU > Job)
- search for points or codes

In the list, the current cursor position is shown in reverse video (it appears as white text on a black background).

Press **[^]** or **[v]** move the cursor one line up or down.

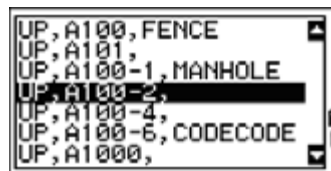

If the Page Up icon **[▲]** appears, there are more pages before the current page. Press **[▲]** to move up one page.

If the Page Down icon **[▼]** appears, there are more pages after the current page. Press **[▼]** to move down one page.

To select an item from the list, move the cursor onto the item and press **[ENT]**.

Inputting Data

Entering a point name or number

You can use numeric or alphanumeric names up to 16 characters long to identify points.

The default name for a new point is the last point name entered, with the last digit incremented. For example, if the last point name was A100, the default name for the next point is A101.

If the last character of the previous point name is alphabetic, the default point name is the last point name.

When the cursor is in a PT (point) field, there are several ways to specify a point, or input coordinates.

Entering an existing point

When you enter a known point name or number, the coordinates of that point are displayed briefly. A short beep sounds before the next screen appears or the next field is selected.

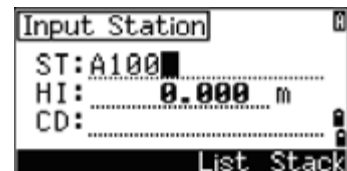

To adjust the duration of the coordinate window display, go to MENU > Settings > Others. To leave the window open until you press (ENT), set the XYZ disp field to +ENT. For more information, see [page 111](#).



Entering a new point

When you input a new point name or number, a coordinate input screen appears. Enter the point's coordinates in NE, NEZ, or elevation-only (Z) format.

Press (ENT) on the last line (the CD field) to store the point in the current job.

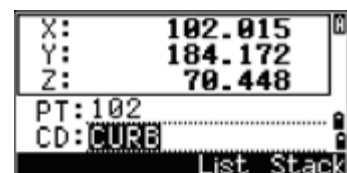
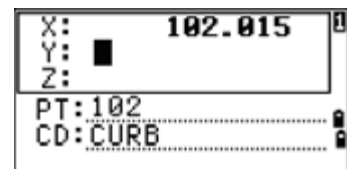

Pressing (ENT) without a point name

To use a point without recording the coordinates, press (ENT) in a PT field, without entering a point name.

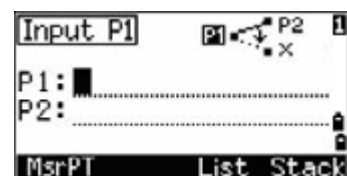

The input coordinates are used in the calculation. They are not saved in the database.

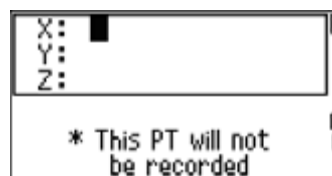

Specifying a wildcard (*)

If you include an asterisk (*) when you enter a point or code name, a list of points that match the entered text appears.

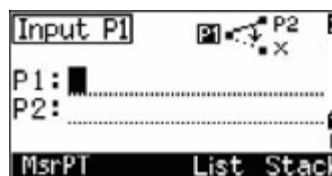

Use \uparrow or \downarrow to move the cursor to the point that you want to use. Then press ENT .

If the Page Up \uparrow or Page Down \downarrow icons are displayed, use \leftarrow or \rightarrow to page up or page down the list.

When you select a point from the list, its coordinates are displayed and a beep sounds.

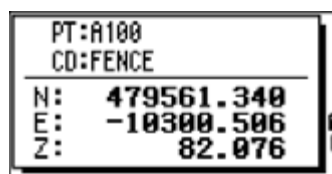

Recording an instant measurement

You can also input a point by recording an instant measurement. To do this, press the MSR softkey.



An observation screen appears.

Press MSR1 or MSR2 to start a measurement. To change the height of the target, press the HT softkey.

To go to the point recording screen when you have finished the measurement, press ENT .

Enter the point or code name. Press ENT .

When you move the cursor to a field, the current or default value appears in inverted text (this is the default "Replace All" input mode).

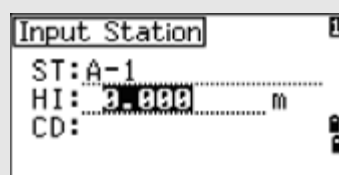

Press \rightarrow to change the input mode to Overwrite mode and highlight the first character. Press \leftarrow to move the cursor the end of the string.

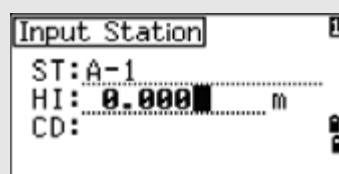

Entering a point from the stack

The point stack is a list of recently used points. To display the stack, press the **Stack** softkey when the cursor is in the *PT* field.

Use **▲** or **▼** to move the cursor to the point that you want to use. Then press **ENT**.

When you return to the point input screen, the selected point name is entered in the *PT* field, incremented by one. For example, if you selected the A101 point, A102 appears in the *PT* field.



The stack shows the last 20 point names used, in chronological order from last used to first used.

Entering a point from the point list

To display a list of existing points, press the **List** softkey when the cursor is in the *PT* field.

Use **▲** or **▼** to move the cursor to the point that you want to use. Then press **ENT**.

When you return to the point input screen, the selected point name is entered in the *PT* field. You can add digits or alphabetic characters if required.

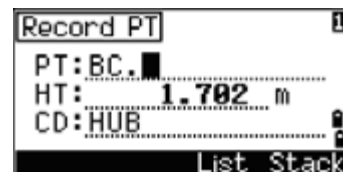

Entering a code

The *CD* (Code) field always defaults to the last code used. You can change the selected code on the input point screen, or you can press **[COD]** in the BMS. For more information, see **[COD] key, page 38**.

You can use numeric or alphanumeric names up to 16 characters long to identify codes.

Entering a code directly

To enter a code directly, press **[MODE]** to change the input mode to alphanumeric or numeric mode. Then use the keypad to enter the code.

Entering a code from the stack

The code stack is a list of recently used codes. The stack may contain up to 20 codes.

To display the stack, press the **Stack** softkey when the cursor is in the *CD* field.

Use **▲** or **▼** to move the cursor to the code that you want to use. Then press **ENT**.

The selected code is copied to the *CD* field.

When the instrument is rebooted, the code stack is cleared.

Entering a code from the code list

To display a list of existing codes, press the **List** softkey when the cursor is in the *CD* field.

To edit the code list, go to **MENU > Data > Code List**. For more information, see [Editing an item in the point list or code list, page 121](#).

Use **▲** or **▼** to highlight the feature code that you want to use. Then press **ENT**.

A layer has an arrow at the end of the code label. If you highlight a layer in the list and then press **ENT**, the codes and layers in that layer are displayed.

When you return to the input screen, the selected code is entered in the *CD* field.

Items are shown in alphabetic order.

You can also use the first character search to quickly find a code. For more information, see [Advanced feature: Searching for a code by using the first character, page 46](#).

Advanced feature: Searching for a code by using the first character

To find a code quickly when the code list appears, use the first-character search.

For example, to see feature codes that begin with T, use the keypad to enter the letter T. To do this, press **T** twice.

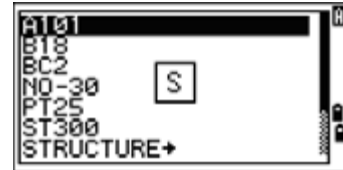

After each press of the key, the input mode field displays the selected letter. For example, if you press **T**, **S** appears. If you quickly press **T** again, **T** appears. If you do not press the **T** key again, the letter T is selected.

Once you have selected a letter, the cursor moves to the feature code beginning with that letter.

If there is no code beginning with that letter, the cursor moves to the next available letter.

Qcodes

Quick codes (Qcodes) let you shoot and record many points with feature codes in the field. You can register up to ten Quick codes. To register Qcodes, press the **Edit** softkey. For more information, see [Quick code measurement mode, page 37](#).

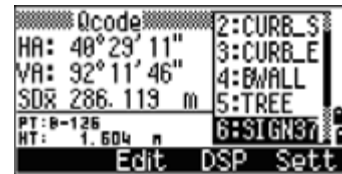

Press **MODE** to switch Qcodes on or off.

Press the **Edit** softkey to change the Qcode. You can edit the entire code, or just the number at the end of the code.

You can still use **DSP** to change the background displays.

Entering values in feet and inches

When either US Survey Feet (US-Ft) or International Feet (I-Ft) is selected as the distance unit, you can enter and display distances, HIs, HTs, and coordinate values either in decimal feet, or in feet and inches. For more information, see [Unit, page 110](#), and [Others settings, page 111](#).

To enter values in feet and inches in an input screen, enter the elements, separated by periods (.), in the following format:

<Feet> [] <Inches> [] <Numerator> [] <Denominator> [] **ENT**
 (0–11) (0–15) (0–99)

The default denominator is 16. If the denominator is 16, you do not have to enter it, and it is not displayed on the screen.

For example, if you enter 2 [.] 0 [.] 8 [.] 5 [.] **ENT**, it appears as 2' 08" 5/ (2 feet, 8 and 5/16ths inches).

The following examples show how various values are entered:



To enter ...	Type ...
65' 5 3/8"	6 5 [.] 5 [.] 3 [.] 8 ENT
65'	6 5 ENT
65' 5"	6 5 [.] 5 ENT
65' 5 3/8"	6 5 [.] 5 [.] 6 ENT
5 3/8"	0 [.] 5 [.] 3 [.] 8 ENT or 0 [.] 5 [.] 6 ENT

The numerator and denominator that you enter are automatically converted to the closest value from the following list: 0, 1/8, 1/4, 3/8, 1/2, 5/8, 3/4, 7/8, 1/16, 3/16, 5/16, 7/16, 9/16, 11/16, 13/16, 15/16.

If the denominator is 16, it is not shown on the screen.

Jobs

To record data on the instrument, you must create or open a job.



Tip – Before you use the instrument for the first time, check the job settings.

Creating a new job

1. Press **MENU** to open the MENU screen.
2. Press **1** to open the Job Manager.
3. Press the **Cre**at softkey to open the Create Job screen.
4. Enter the job name.
5. Press the **Sett** softkey to check the job settings. You cannot change a job's settings once you have created the job.
6. Press **ENT** in the last field of the Job Sett screen to create the new job.



If either of the messages MAX 50JOBS or Data Full appears, delete at least one existing job to free space. You cannot free space by deleting records in an existing job.

Creating a control job

A control job, or common file stores coordinate data that is used by several field jobs. You can create a control job in the office.

1. Press **MENU** to open the MENU screen.
2. Press **1** or select **JOB** to open the Job Manager.
3. Move the cursor to the job that you want to use as the control job.
4. Press the **FNC** softkey.



5. Press \square to open the Control Job screen.
6. Press the $\text{V}\equiv$ softkey.

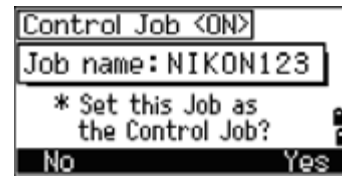

When you enter a point name or number, the system searches in the current job first. If the point is not found in the current job, the search is automatically extended to the control job. If the point is found in the control job, the selected point is copied to the current job as a UP record.

Measuring Distances

Sighting a prism reflector



WARNING – Never look at the sun through the telescope. If you do, you may damage or lose your eyesight.



WARNING – Precautions should be taken to ensure that persons do not look directly, with or without an optical instrument, into the beam.



WARNING – Laser beam path should be located well above or below eye level wherever practicable.

For information on how to assemble the prism reflector, see [Setting Up the Prism Reflector](#), page 22.

Sight the telescope to see crosshairs at the center of the prism reflector.

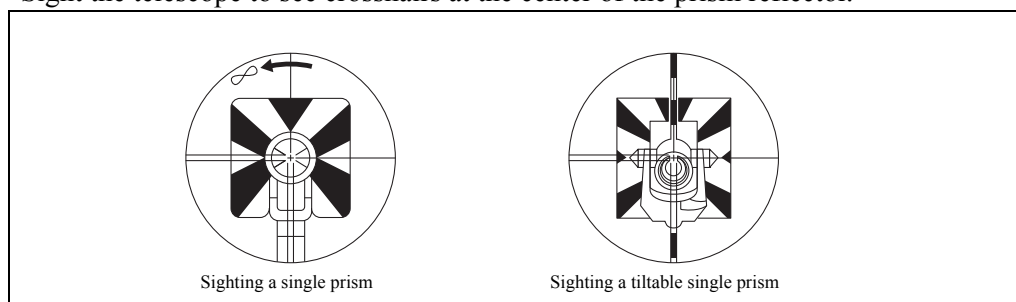

Measuring distances

To take a distance measurement, press MSR1 or MSR2 in the Basic Measurement Screen (BMS) or in any observation screen.

While the instrument is taking a measurement, the prism constant appears in a small font.

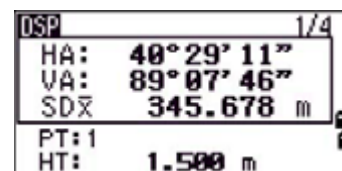

If the average count is set to 0, measurements are taken continuously until you press **[MSR1]**, **[MSR2]**, or **[ESC]**. Each time a measurement is taken, the distance is updated.

If the average count is set to a value from 1 to 99, the averaged distance appears after the last shot. The field name SD changes to \overline{SD} to indicate the averaged data.

To change the height of target (HT), temperature, or pressure, press **[HOT]**. For more information, see **[HOT] key, page 38**.

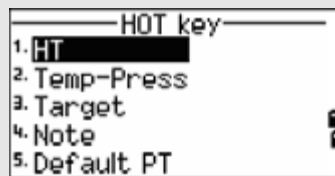

Settings that relate to corrections:

(T-P corr, Sea Level, C&R corr., and Map projection) are included in the job settings. These settings are job-specific. If you need to change any of these settings, you must create a new job. For more information, see **Job settings, page 93**, and **Settings, page 106**.

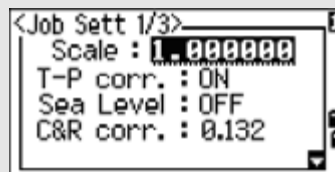

Measurement settings

To view the measurement settings, hold down **[MSR1]** or **[MSR2]** for one second.

Use **[^]** or **[v]** to move the cursor between the fields. Use **[<]** or **[>]** to change the value in the selected field.

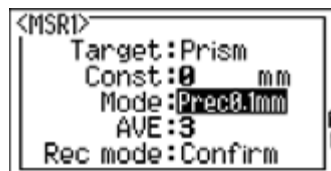

Field	Values
Target	<ul style="list-style-type: none"> Prism N-prism
Const (prism constant)	-999 mm through 999 mm
Mode	<ul style="list-style-type: none"> Prec0.1mm Prec1mm Norm10mm Fast10mm <p><i>Note that "Prec0.1mm" is the same accuracy as "Prec1 mm," only display resolution is different.</i></p>
AVE (Average count)	0 (Continuous) through 99
Rec mode	One of the following: <ul style="list-style-type: none"> MSR only Confirm ALL

Target field

If the measurement is started with the Target field set to **Prism**, there is a dash “-” in front of the prism constant.

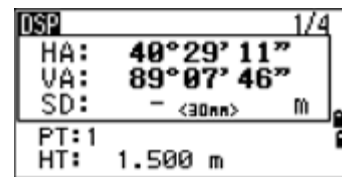

If the measurement is started with the Target field set to **N-prism**, there is a square bracket “]” in front of the prism constant.

The symbol then constantly runs from left to right over the prism constant in the display.

When an N prism measurement is taken, the  icon appears in the status bar (above the battery icon).

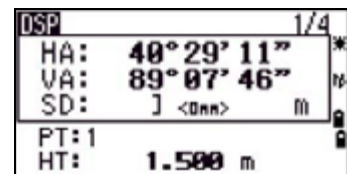

Incorrect Target settings may result in measurements outside the precision and intervals specified for the instrument.

If a prism target is aimed in the N-prism mode, the warning message "Signal High! → Try Prism Mode" will be displayed because of the excessive light reflection.

A measurement made immediately after changing the target setting may take a longer time than usual. The Target setting is used to apply better cyclic-error adjustment in distance measurement. It efficiently eliminates multipath reflection.

Rec mode field

The Rec mode setting controls how the **MSR1** and **MSR2** keys operate in the BMS.

The **MSR only** setting is the default measurement mode. After a measurement, the instrument stops in the BMS and waits for you to press **ENT** before recording the point.

The **Confirm** setting displays the Record PT screen before data is recorded.

The **ALL** setting is a quick shooting and recording mode. The instrument automatically records the point using the default PT/CD. The instrument then returns to the BMS for the next measurement.

Applications

In this chapter:

- HA Reset and Angle Operations
- Station Setup
- Stakeout
- Program Key
- Recording Measurement Data
- Measuring Offsets

HA Reset and Angle Operations

To open the *Angle* menu, press **[ANG]** in the BMS. To select a command from this menu, either press the corresponding number key, or press **[←]** or **[→]** to highlight the command and then press **[ENT]**.

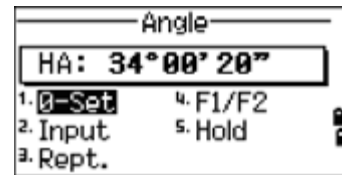

Setting the horizontal angle to 0

To reset the horizontal angle to 0, press **[0]** or select **0-Set** in the *Angle* menu. The display returns to the Basic Measurement Screen (BMS).

Entering the horizontal angle

To display the *HA Input* screen, press **[2]** or select **Input** in the *Angle* menu. Use the numeric keys to enter the horizontal angle. Then press **[ENT]**.

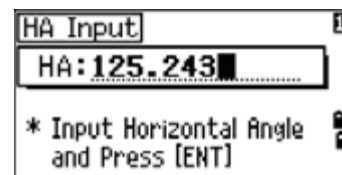

To enter 123°45'50", type **[1][2][3][.][4][5][5][0]**.

The displayed value is rounded to the minimum angle increment.

Recording a foresight point after repeat angle measurement

- To activate repeat angle measurement, press **[3]** or select **Repeat** in the *Angle* menu.

HR=0 appears.

- Sight the backsight and press **[ENT]**.
- Sight the foresight and press **[ENT]**.

The horizontal angle is accumulated and the value is held again.

- To end repeat angle measurement, press **[ESC]**.
- When you have accumulated enough horizontal angle between the backsight and the foresight, press **[MSR1]** or **[MSR2]** to take a measurement to the foresight.

The averaged horizontal angle appears. This value is fixed until the process is finished or cancelled.

$$\overline{HRx} = \overline{HR\Sigma} \div N$$

$$HA = BSAZ + \overline{HRx} \text{ (normalized)}$$

\overline{HRx} is not updated even if the instrument is moved.

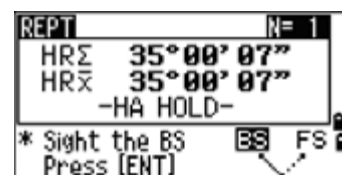
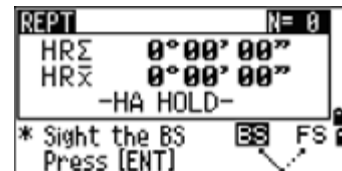

6. Press [ENT] to store the foresight as a CP record. Check the PT, HT, and CD values. Then press [ENT] to record.

In repeat angle measurement, the HA is replaced by HR Σ . The number of repeat angles appears at the top of the screen (for example, HR= 5).

Horizontal angles can be measured up to 1999°59'59".

This function stores both raw and XYZ data as CP records, regardless of the Store DB setting.

Face-1/Face-2 measurement

Use Face-1/Face-2 (F1/F2) measurements to obtain maximum accuracy for measuring angles. Using F1/F2 measurements effectively cancels out mechanical constant error, except for some special errors such as the vertical axis error. For more information, see [Face-1/Face-2 Measurement, page 24](#).

To take F1/F2 data without taking a distance measurement, press [4] or select F1/F2 in the *Angle* menu.

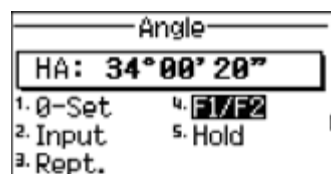

If you have already taken a distance measurement to the target, you can initiate F1/F2 averaging by flipping the telescope to the other face.

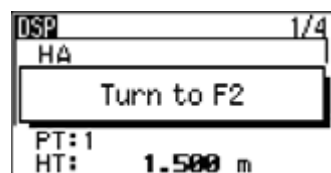

Press [ENT] on Face-2. The delta screen appears.

To record the averaged HA, VA, and SD from the F1/F2 data, press [ENT] or the OK softkey and select the CP or SS record type.

For the HA to be adjusted from a F1/F2 measurement, the Backsight must also have been measured in F1/F2 during the station setup.

Horizontal angle hold

To hold the horizontal angle to the current value, press [5] or select Hold in the *Angle* menu.

To set the horizontal angle to the displayed value, press [ENT] or the Set softkey.

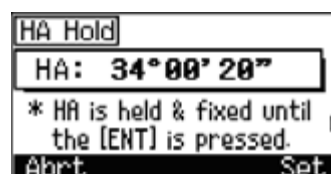

To cancel the process and return to the Basic Measurement Screen (BMS), press [ESC] or the Abt softkey.

Station Setup

To open the *Stn Setup* menu, press **[STN]** in the BMS.

To select a command from this menu, press the corresponding number key. Alternatively, press **[←]** or **[→]** to highlight the command and then press **[ENT]**. Press **[↑]** or **[↓]** to move up or down one page.

The last function used is highlighted.

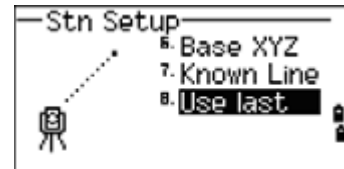
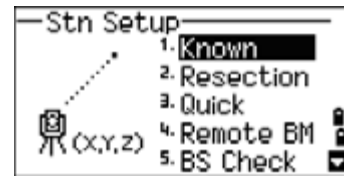

Setting up a station with known coordinates or azimuth

1. Press **[1]** or select **Known** in the *Stn Setup* menu.
2. Enter a point name or number in the *ST* field.
 - If the input point number or name is an existing point, its coordinates are displayed and the cursor moves to the *HI* (Height of instrument) field.
 - If the point is new, a coordinate input screen appears. Enter the coordinates for the point. Press **[ENT]** after each field. When you press **[ENT]** in the *CD* field, the new point is stored.
 - If the specified point has a code, the code appears in the *CD* field.
3. Enter the instrument height in the *HI* field and then press **[ENT]**.



The *Backsight* screen appears.

4. Select an input method for defining the backsight point.
 - To sight the backsight by entering coordinates, see below.
 - To sight the backsight by entering the azimuth and angle, see [page 58](#).

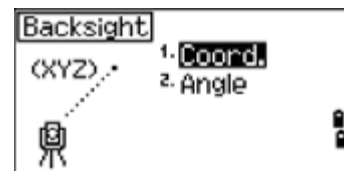

Sighting the backsight by entering coordinates

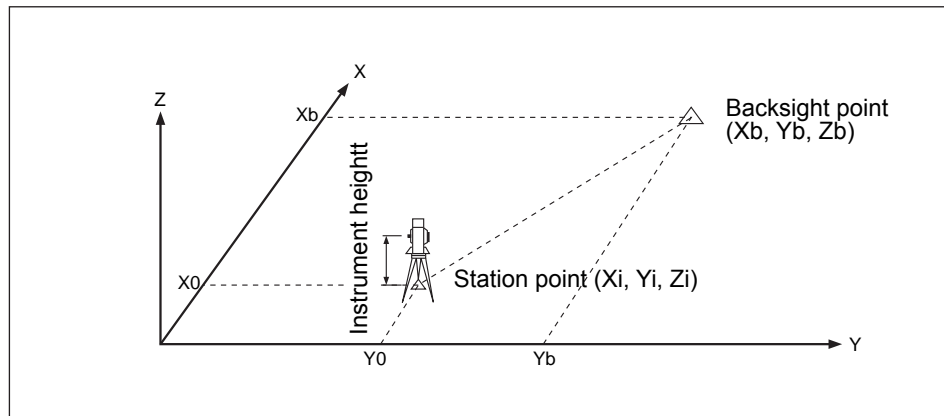

1. To enter coordinates for the backsight point (BS), press **[1]** or select **Coord** in the *Backsight* screen.
2. Enter the point name. If the point exists in the job, its coordinates are shown.
3. If you intend to take a distance measurement to the BS, enter the height of target in the *HT* field.
4. Sight the BS on Face-1 (F1). Press **[ENT]** to complete the setup.
 - To record a full shot (with HA, VA, and SD values) to the BS, press **[MSR1]** or **[MSR2]**.

AZ Azimuth calculated by coordinates

- If you are measuring to a known coordinate BS, press **[DSP]** to display a QA screen. The QA screen shows the dHD and dVD values, which indicate the difference between the measured distance and the distance calculated from the known coordinates.
5. To record the station, press **[ENT]**.
 6. To finish the station setup after taking a distance measurement, press **[ENT]**. ST and F1 records are stored to the current job.

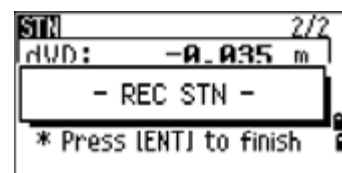
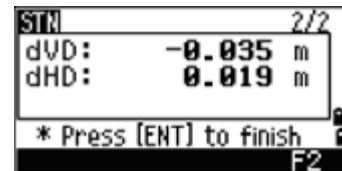

Advanced feature: Measuring F1 and F2

To take an angle shot and proceed to the next measurement on Face-2, press the F2 softkey.

To go directly to the Face-2 measurement after taking a distance measurement to the BS on Face-1, flip the telescope. The instrument automatically detects F1/F2.

Press [ENT] on Face-2. The delta screen appears.

To record the ST and F1/F2 records, press [ENT] or the \square softkey.

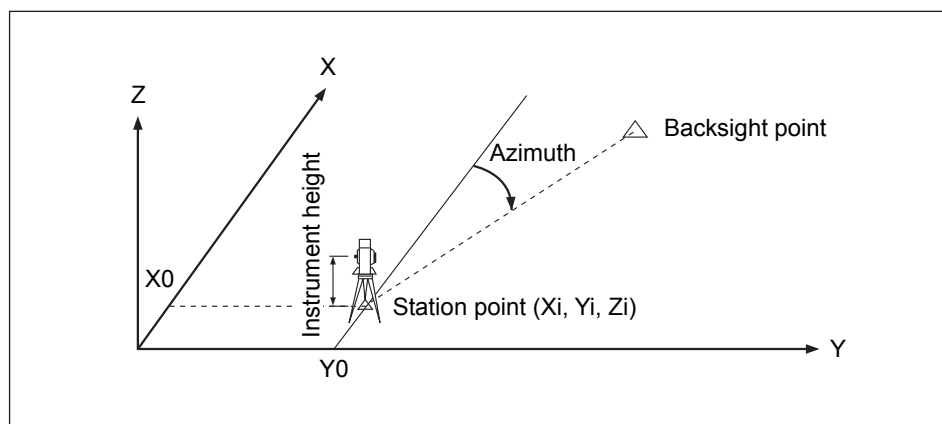
**Sighting the backsight by entering the azimuth angle**

1. To enter the azimuth angle to the backsight point, press \square or select **Angle** in the *Backsight* screen.
2. The *Input BS Point* screen appears. If there is no point name for the BS, press [ENT] on the *BS* field.
3. The *Input BS Angle* screen appears. In the *AZ* field, enter the azimuth angle to the BS point.

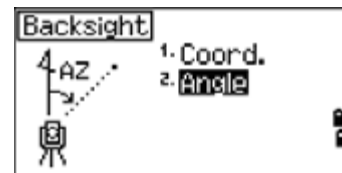

If you press [ENT] without entering a value in the *AZ* field, the azimuth is automatically set to 0°00'00".

4. Sight the BS point and press [ENT]. ST and F1 records are stored in the job.

You can also use the F2 softkey for F1/F2 measurement. See [Advanced feature: Measuring F1 and F2](#), page 58.

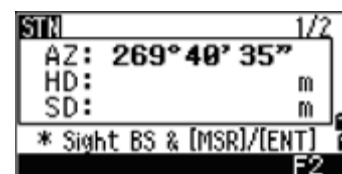

Setting up a station using multiple point resection

A resection sets up the station using angle/distance measurements to known points.

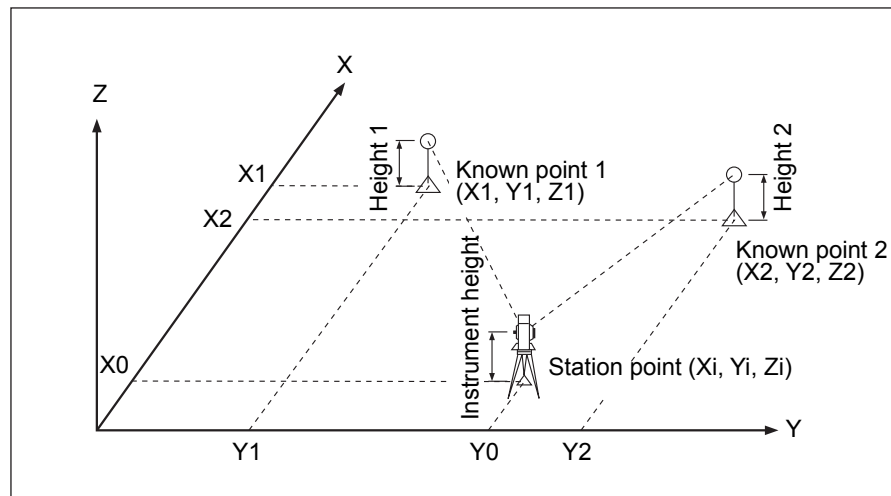

You can use a maximum of 10 points in a resection. Measurements can be distance and angle, or angle only. Calculation starts automatically when enough measurements are taken.

You can delete poor observations and recalculate if necessary. You can also select the BS point.

If the angle between known point 1 and known point 2 (measured from the station point) is extremely acute or extremely oblique, the resulting solution will be less reliable geometrically. For geometric reliability, select known point locations (or station point locations) that are widely spaced.

1. To start the resection, press **[2]** or select **Resection** in the *Stn Setup* menu.
2. Enter the point name for the first observation point (PT1).
3. Enter the target height and press **[ENT]**.
4. Sight PT1 and press **[MSR1]** or **[MSR2]**.

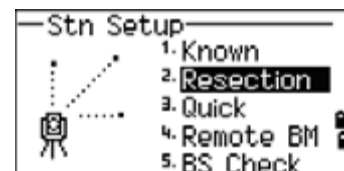

To use the **F2** softkey for F1/F2 measurement, see [Advanced feature: Measuring F1 and F2](#), page 58.

5. To proceed to the next point, press **[ENT]**.
6. Enter the second point (PT2) and its height of target.
7. Measure to PT2 and press **[ENT]**.

When the instrument has enough data, it calculates the station (STN) coordinates.

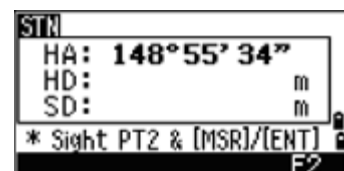

- If more than the minimum required data is available, a standard deviation screen appears.
- To take measurements to strengthen geometry of the resection, press the **Add** softkey. For information about the **View** softkey, see [Advanced feature: Viewing and deleting a measurement in resection](#), page 61.

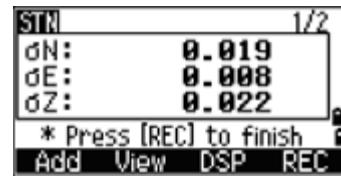

8. When the results are satisfactory, record the station. To do this, press **[ENT]** or the **REC** softkey.
9. Enter the height of instrument, if required. Press **[ENT]**. The *ST* field defaults to the last recorded *PT* + 1.
10. To change the station name, move to the *ST* field and edit or replace the text.

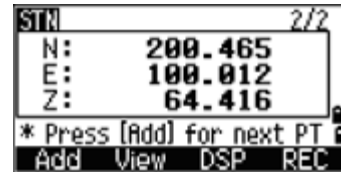

If you have set Split ST to Yes, the *ST* field defaults to the last recorded *ST* value + 1. For more information, see [Others settings](#), page 111.

BS defaults to the first observed point.

11. To change the BS, press the **Change** softkey.
12. The *Select BS point* screen appears. Select the BS point that you want to use and press **[ENT]**.
13. To finish the resection setup, move the cursor to the BS field and press **[ENT]**.

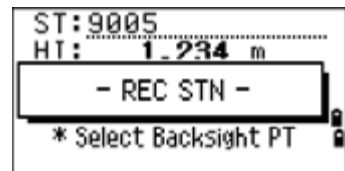

The minimum data required for a resection is either three angle shots, or one angle shot and one distance shot. If you use a distance shot, the distance between the target points must be greater than the measured distance. Stn-Z is calculated from distance-measured data. If no distances are measured, then Stn-Z is calculated using angle-only measurements to points with 3D coordinates.

Advanced feature: Viewing and deleting a measurement in resection

To check the measurements to each known point, press the **View** softkey on the calculated STN (sigma or coordinate) screen.



dHA	Distributed HA errors in each direction
dVD	VD errors between measured distance and calculated distance
dHD	HD errors between measured distance and calculated distance

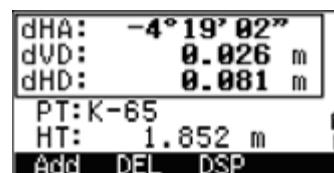

To delete a measurement (because of large sigma values, for example), highlight the measurement data or display the detail screen for the measurement. Then press the **DEL** softkey. The STN coordinates are automatically recalculated.

To continue resection observations, press the **Add** softkey. The input screen for the next PT appears.

Setting up the station quickly without coordinates

The station point (ST) in this function defaults to a new point number. For the new point, MP (0, 0, 0) is stored as the coordinates. When the ST is manually changed to a known point name, the station is set up on the coordinates of the known point.

- To enter Quick Station setup, press **3** or select **Quick** in the *Stn Setup* menu.

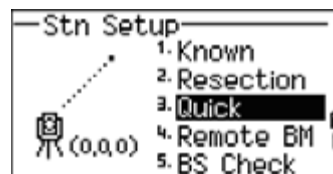

ST	Station point (defaults to the last recorded PT + 1, or ST + 1, depending on the Split ST setting)
HI	Height of instrument
BS	Backsight point (blank)
AZ	Backsight azimuth (defaults to zero)

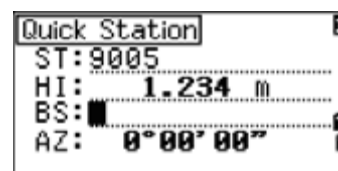

- No default PT is assigned to the BS. Leave this field blank, or enter a BS point name.
- The backsight azimuth (AZ) defaults to zero, but you can change this.
- To complete the station setup, sight the BS and press **ENT**.

When you press **[ENT]** in the AZ field, both HA and AZ are reset to the value you have entered.

Even if both ST and BS are known points, this function does not calculate the backsight angle (AZ) automatically. To calculate the AZ between two known points (ST and BS), use **Station Setup > Known**. For more information, see [Setting up a station with known coordinates or azimuth](#), page 56.

Determining station elevation

1. Press **[4]** or select **Remote BM** in the *Stn Setup* menu.

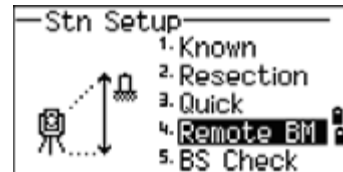

2. The *Input BM* screen appears. Enter the BM point and press **[ENT]**. When the point is found, it appears briefly. The cursor then moves to the HT field.



3. Enter the HT and press **[ENT]**.
4. The *RBM* screen appears. Sight the BM point and press **[MSR1]** or **[MSR2]**.
5. To take an F1/F2 measurement, press the **F2** softkey or flip the telescope to Face-2 after a distance measurement.

The updated station coordinates are displayed. You can change the HI in this screen.

6. To record the updated STN, press **[ENT]**.

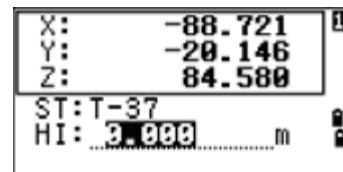

When the HI is changed, the Z coordinate is updated before the station is recorded. You must complete a station setup before you use the Remote Benchmark function.

Checking and resetting the backsight direction

You must complete a station setup before you use the BS check function.

This function always refers to the backsight point from the last ST record stored in the current open job.

1. To enter the backsight (BS) check function, press **[5]** or select **BS Check** in the *Stn Setup* menu.

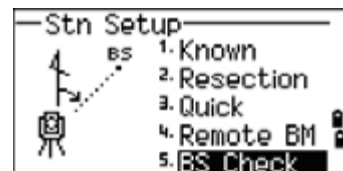

- HA Current HA reading
 BS The HA to the BS in the last station setup. Enter station coordinates for observations without recording data.

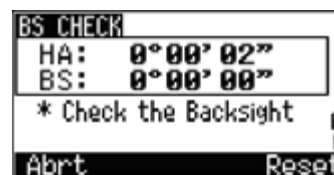

2. Do one of the following:
 - To reset the horizontal angle to the HA set in the last station setup sight the BS and press the **Reset** softkey or press **ENT**.
 - To cancel the process and return to the BMS, press the **Abt** softkey or press **ESC**.

Base XYZ function:

Base XYZ does not store a ST record, so the BS Check cannot check the backsight when you enter a station using Base XYZ.

To store raw data, use one of the other functions in the *Stn Setup* menu. This function does not store an ST record in the job.

You can use this function without an open job. If there is an open job when you use this function, a CO record is stored to indicate that the instrument's base coordinates have changed.

1. To enter the Base XYZ function, press **6** or select **Base XYZ** in the *Stn Setup* menu.

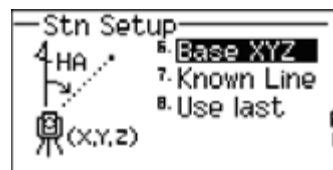

The current instrument XYZ values are shown as the default.

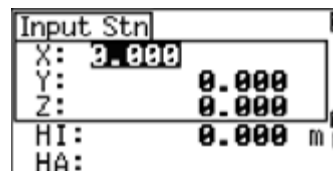

2. Enter the new instrument XYZ values and press **ENT**.
3. Do one of the following:
 - To reset the horizontal angle, enter a value in the *HA* field and press **ENT**.
 - If you do not need to reset the HA, leave the *HA* field blank and press **ENT**.

The display returns to the BMS.

Two-point resection along a known line

- To enter the Known Line function, press **[7]** or select **Known Line** in the *Stn Setup* menu.

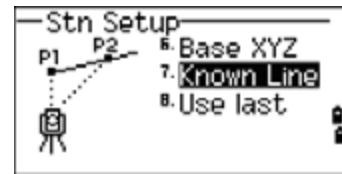

- Enter a known point as P1.

If you enter a new point name, a coordinate input screen appears.

Sight P1 and press **[MSR1]** or **[MSR2]** to take a measurement. Press **[ENT]**.



- Choose how you want to define a known line:

- To define the line by entering P2 coordinates, press **[1]** or select **By Coord.**
- To define the line by entering the azimuth, press **[2]** or select **By Angle.**

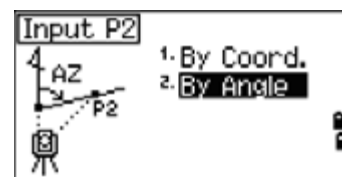

- If you select **By Angle**, the *Input Angle* screen appears. Enter the angle value and press **[ENT]**.

A measurement screen appears.

- Sight P2 and press **[MSR1]** or **[MSR2]** to take a measurement. Press **[ENT]**.

After the measurement to P2 is completed, the coordinates of the station are calculated.

- To record the station, press **[ENT]** or the **REC** softkey.

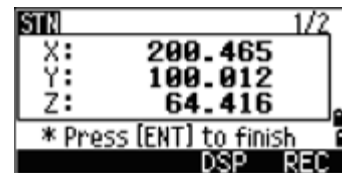

- To check your measurement, press the **DSP** softkey. If you defined the line by entering its azimuth, HD and VD between P1 and P2 are displayed.

If you defined the line by entering the P2 coordinates, the difference of HD (dHD) and VD (dZ) between your measurement data and input coordinate data are displayed.

- Enter the station name, the height of instrument (HI), and a feature code (CD) if required. The station name defaults to the last recorded PT + 1, or last recorded ST + 1, depending on the Split ST setting.

- Backsight (BS) defaults to the first point (P1). To change it, highlight the *BS* field and then press the **Change** softkey.

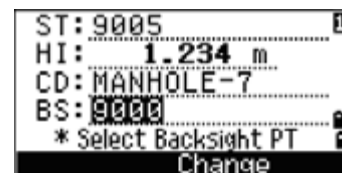

- To finish the setup and record the station, press **[ENT]** in the *BS* field.

Sample records

CO, Temperature:20C Pressure:1013hPa Prism:0 ...

ST,9005, ,265, ,1.2350,150.40300,150.40300

F1,265,1.6040,79.0010,90.30150,89.35260,

F1,200,1.4590,50.2300,269.4035,93.50110,

CO, P1-P2 HD=122.0350 VD=0.5600

Use last station

1. To continue the last station setup in a new job or in a different existing job, open the *Stn Setup* menu by pressing **[STN]** in the Basic Measurement Screen (BMS).
2. Select *Use last*, or press **[8]**.
3. Confirmation screen of the last station point appears. Press **[ENT]** or **[OK]**, and the last station setup will be used in the current job.

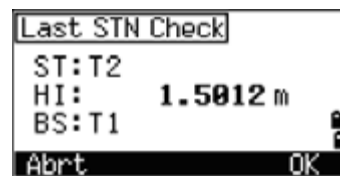
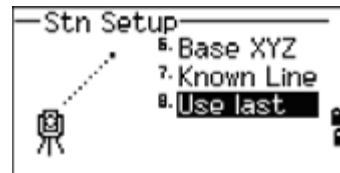

Stakeout

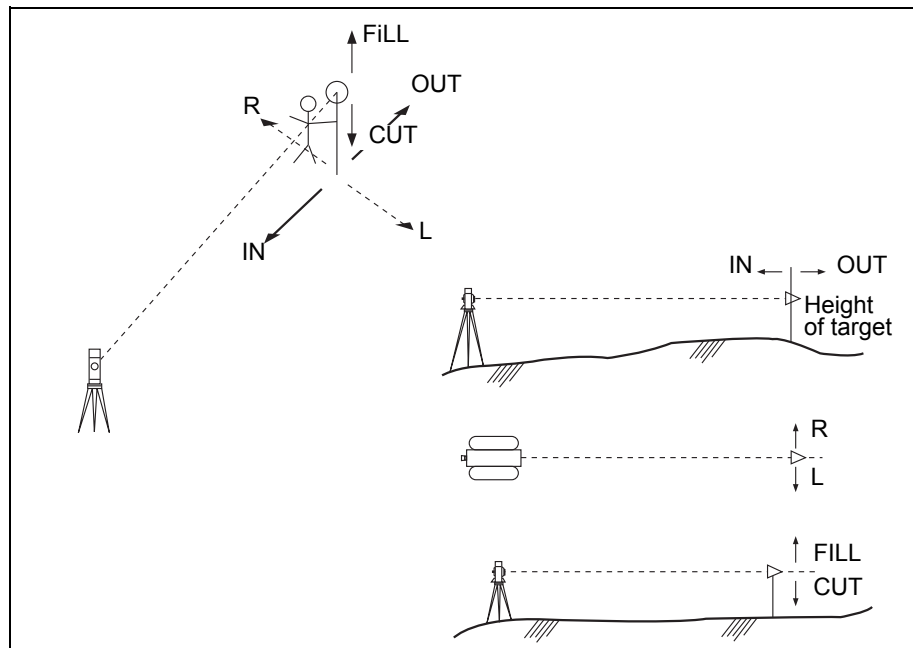

To display the *Stakeout* menu, press **[S-O]**.

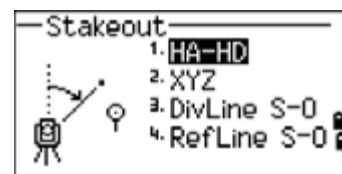

Specifying the stakeout point by angle and distance

- To display the input screen for the distance and angle to the target, press **[1]** or select **HA-HD** in the Stakeout menu.
- Enter the values and press **[ENT]**.

HD Horizontal distance from station point to stakeout point
 dVD Vertical distance from station point to stakeout point
 HA Horizontal angle to stakeout point

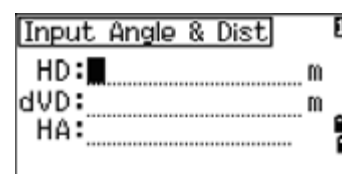

If you press **[ENT]** without entering HA, the current HA is used.

- Rotate the instrument until the dHA is close to $0^{\circ}00'00''$.
- Sight the target and press **[MSR1]** or **[MSR2]**.

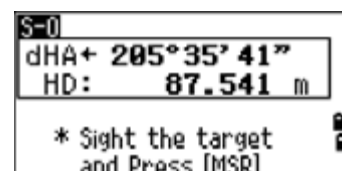

When the measurement is completed, the differences between the target position and the stakeout point are displayed.

dHA	Difference in horizontal angle to the target point
R/L	Right/Left (Lateral error)
IN/OUT	In/Out (Longitudinal error)
CUT/FILL	Cut/Fill

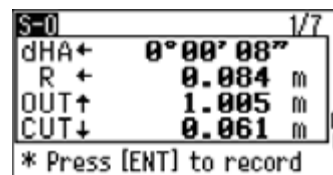

Once a measurement is taken, the Cut/Fill value and Z coordinate are updated as the VA is changed.

If you press **[HOT]** in any observation screen, the HOT key menu appears. You can use this menu at any time to change HT and T-P.

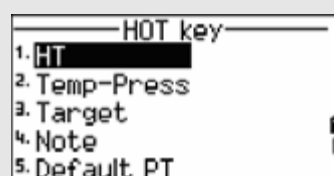

Using **[DSP]** to switch between display screens

Press **[DSP]** to switch between the Stakeout display screens. The following screens are available:

S-01	S-02	S-03	S-04
dHA← R← OUT↑ CUT↑	HA VA SD	HA VD HD	HL U% HD
S-05	S-06	S-07	S-08
X Y Z	dX dY dZ	rSD rVD rHD	HD UD SD

The S-08 screen is only available if the secondary distance unit is set. For more information, see [Others settings, page 111](#).

Every time you press **[DSP]**, the next screen appears. If you press **[DSP]** in the last screen (S-07, or S-08 if the secondary distance unit is set), the S-01 screen appears.

To customize the S-02, S-03, and S-04 screens, hold down **[DSP]** for one second. For more information, see [Customizing items in the Basic Measurement Screen \(BMS\), page 36](#).

To record the stakeout point, press **[ENT]**. PT defaults to the last recorded PT+1.

Press **[ENT]** to record the point.

After recording the point, it returns to the observation screen. You can continue observation, or press **[ESC]** to input another angle and distance for stakeout.

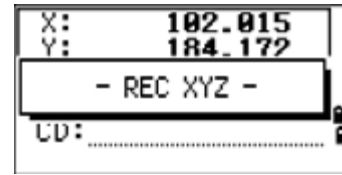

Specifying the stakeout point by coordinates

1. To start a stakeout by coordinates, press **[2]** or select **XYZ** in the Stakeout menu.

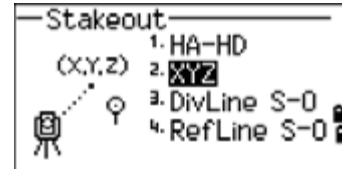

2. Enter the point name that you want to stake and press **[ENT]**.

You can also specify the point by code or radius from the instrument.



If several points are found, they are displayed in a list. Use **[^]** or **[v]** to move up and down the list. Use **[<]** or **[>]** to move up or down one page.

3. Highlight a point in the list and press **[ENT]**.

The delta angle and the distance to the target are shown.

4. Rotate the instrument until the dHA is close to $0^{\circ}00'00''$. Press **[MSR1]** or **[MSR2]**.

dHA Difference in horizontal angle to the target point
HD Distance to the target point

5. Ask the rodman to adjust the target position.
When the target is on the intended position, the displayed errors become 0.000 m (or 0.000 ft).

dHA Difference in horizontal angle to the target point
R/L Right/Left (Lateral error)
IN/OUT In/Out (Longitudinal error)
CUT/FILL Cut/Fill

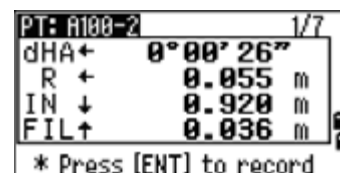

To switch between display screens, press **[DSP]**. This function works as in the angle-distance stakeout, except that the screen counter (for example, S-O1/8) is not displayed. For more information, see [Using \[DSP\] to switch between display screens, page 67](#).

Once a measurement is taken, the Cut/Fill value and Z coordinate are updated as the VA is changed.

- To record the point, press **[ENT]**. PT defaults to the specified PT + 1000.

Use the Add Constant field in MENU > Settings > Stakeout to specify an integer that is added to the point number being staked to generate a new number for recording the staked point. The default value is 1000. For example, when you stake out PT3 with an Add Constant of 1000, the default number for SO record is 1003. For more information, see [Stakeout, page 110](#).



After recording the point, the display returns to the observation screen. When you press **[ESC]**, the display returns to the PT/CD/R input screen. If you entered the stakeout point using a single point name, the PT defaults to the last PT + 1.

If you selected a point from the list, the display returns to the list, unless all points have been selected. Press **[ESC]** to return to the point input screen.

Advanced feature: Specifying a stakeout list by range input

- To input points by range, press the **Fr/To** softkey in the *PT* field.
- Enter the start point (Fr) and the end point (To). The range between Fr and To must be less than 1001 points.

If existing points are found between Fr and To, a point list appears.

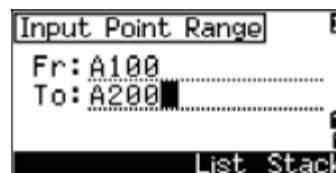

To highlight a point, press **[^]** or **[v]**. To go to the stakeout observation screen, press **[ENT]**.

If you have assigned a control job, and additional points are found in the control job, the **Ctrl** softkey appears under the list.

DivLine S-0

This function divides the line between the instrument and the first target by an input span number. It then guides you to stake out the points, one by one.

- Press **[3]** or select **DivLine S-0** in the Stakeout menu.
- Set up the baseline. To do this, sight the target on the line (the end point) and press **[MSR1]** or **[MSR2]**.

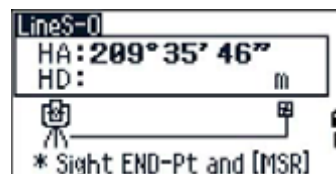
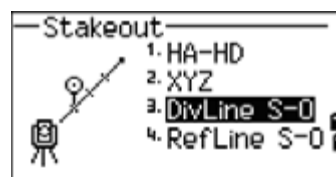

3. Enter the total stake number in the *Span total* field.

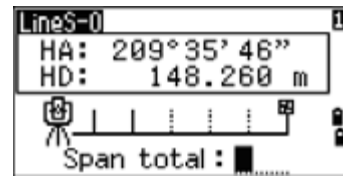

The observation screen for the first stake (from the instrument) appears.

4. Sight the prism and press **[MSR1]** or **[MSR2]**.
5. Use **[▲]** or **[▼]** to change the guide point. You can calculate and guide up to double the number of the stakes.
6. To record the point as an SO record, press **[ENT]**.

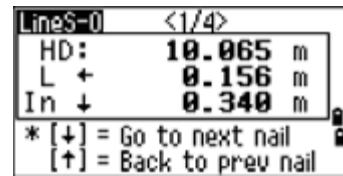

For example, if you measure to the end point at 100 m from the instrument and set the span total to 2, the following four points are calculated and can be staked:

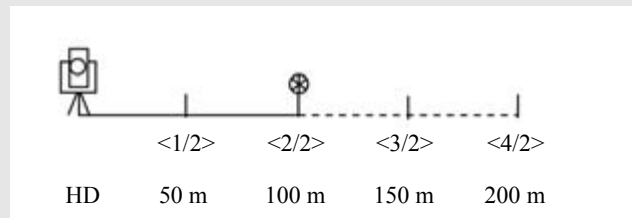

RefLine S-O

This function allows you to stake out a point based on the Sta, O/S, and dZ to a specified line.

1. Press **[4]** or select **RefLine S-O** in the *Stakeout* menu.
2. Enter the first point (P1) of the line.

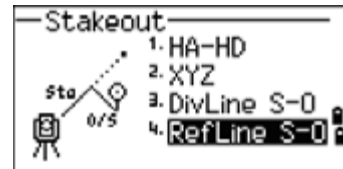

If you press **[ENT]** without entering a PT name, you can enter temporary coordinates which are not recorded in the job.

Alternatively, press the **[MSR]** softkey to measure a point.

3. Enter the second point (P2) of the line.
4. Enter offsets to the line.
Press **[ENT]** in a blank field to enter the value 0.0000.

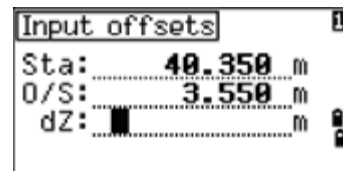

- Sta Distance from P1 along the line
- O/S Distance perpendicular to the line
- (+) Right side of the P1-P2 line

- (-) Left side of the P1-P2 line
 - dZ Difference in height from the line
5. Rotate the instrument until the dHA is close to $0^{\circ}00'00''$.
 6. Sight the target and press **[MSR1]** or **[MSR2]**.
When a distance measurement is taken, the difference from the design point appears.
 7. To record the point as an SO record, press **[ENT]**.

Using **[DSP]** to switch between display screens

You can use **[DSP]** to switch between display screens. This function works as in the angle-distance stakeout. For more information, see [Using **\[DSP\]** to switch between display screens, page 67](#).

Program Key

To display the *Programs* menu, press **[PRG]**.

Measuring distance and offset values along a specified line

1. Press **[1]** or select 2Pt RefLine in the *Programs* menu.
2. Enter the first point for the reference line.
Alternatively (to enter the point by measuring), press the **MSRPT** softkey.

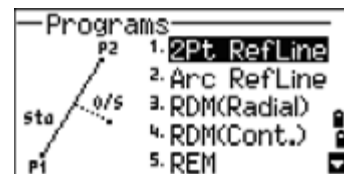

Direct Measurement screen

Press the **MSRPT** softkey to display a direct measurement screen. Sight the target and press **[MSR1]** or **[MSR2]**. The Record PT screen appears. If you press **[ESC]** in the Record PT screen, the measured point is used but not recorded in the job.

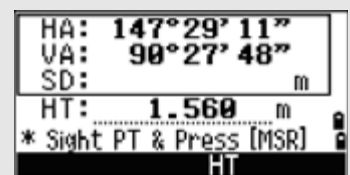

3. Enter the second point for the reference line.

- Enter an asterisk (*) in the *PT* field to perform a wildcard search. A list of matching points appears. Highlight a point in the list and then press **[ENT]**.

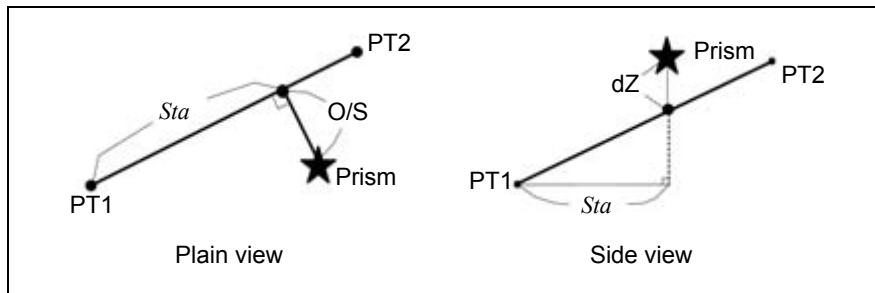

- Sight the prism or reflective sheet and press **[MSR1]** or **[MSR2]**.

Sta Horizontal distance from P1 to the measure point along the P1-P2 line
 O/S Horizontal offset from the P1-P2 line to the measured point
 dZ Vertical offset from the P1-P2 line to the measured point

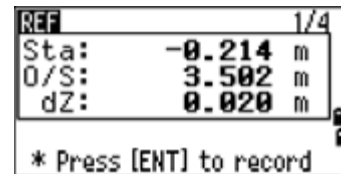

Using **[DSP] to switch between display screens**

Press **[DSP]** to switch between the Stakeout display screens. The following screens are available:

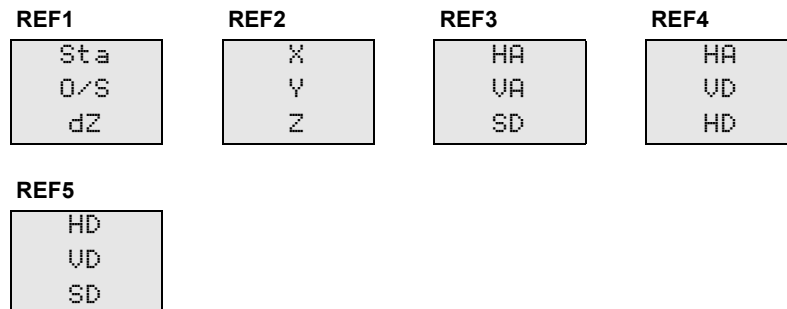

The REF5 screen is only available if the secondary distance unit is set. For more information, see [Others settings, page 111](#).

Every time you press **[DSP]**, the next screen appears. If you press **[DSP]** in the last screen (REF4 or REF5), the REF1 screen appears.

To store the point and its offset distance information, press **[ENT]**.

Enter the point name and feature code.

You can also use this screen to change the HT value.



Sample records

CO, 2pt-Ref Pt:16 & Pt:13 Az:311.2932
 CO, Sta= -12.6876 Offset= 1.3721 dZ= 0.0971
 SS,17,1.0000,6.9202,18.4700,80.3120,15:48:48,2REF-LINE

Measuring distance and offset values on the arc-curve

1. Press **[2]** or select **Arc RefLine** in the *Programs* menu.
2. Enter the start of the curve point (P1) and the azimuth of its tangent line (AZ1).
3. To enter P1 by direct measurement, press the **MSR** softkey.
4. Choose a method to define the arc.
 P2 can be any point on the tangent line that is to exit the curve.
5. In the radius (*Rad*) field, enter a positive value for a clockwise curve. Enter a negative value for a counterclockwise curve.

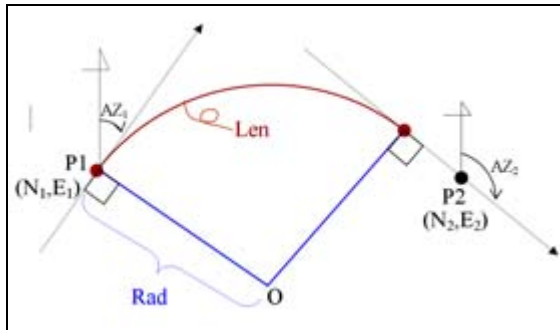
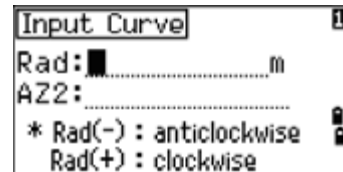
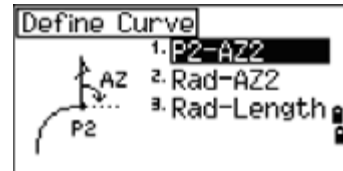
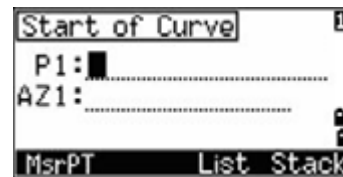
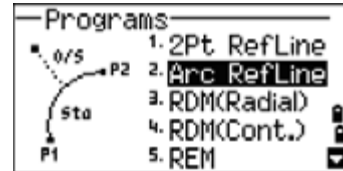

When all factors have been entered, the instrument calculates the curve.

If the curve length (Len) is too large for a circle of the given radius, it is shortened.

To ...	press ...
switch between display screens	[DSP]

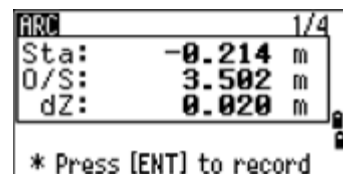

To ...	press ...
change HT	[HOT]
record points	[ENT]

Using [DSP] to switch between display screens

Press [DSP] to switch between the Stakeout display screens. The following screens are available:

ARC1	ARC2	ARC3	ARC4
Sta O/S dZ	X Y Z	HA VA SD	HA UD HD
ARC5			
HD UD SD			

The ARC5 screen is only available if the secondary distance unit is set. For more information, see [Others settings, page 111](#).

Every time you press [DSP], the next screen appears. If you press [DSP] in the last screen (ARC4 or ARC5), the ARC1 screen appears.

To record the point, press [ENT] on any observation screen. The arc is stored in comment records.

Sample records

```
CO,Arc P1:583 AZ1=0.0000 P2:102
CO, AZ2=311.2932 Radius=50.0000 Length=125.6637
CO, Sta= -12.6876 Offset= 1.3721 dZ= 0.0971
SS,17,1.0000,6.9202,18.4700,80.3120,15:48:48,2REF-LINE
```

Remote distance measurement

This function measures the horizontal distance, vertical distance, and slope distance between two points.

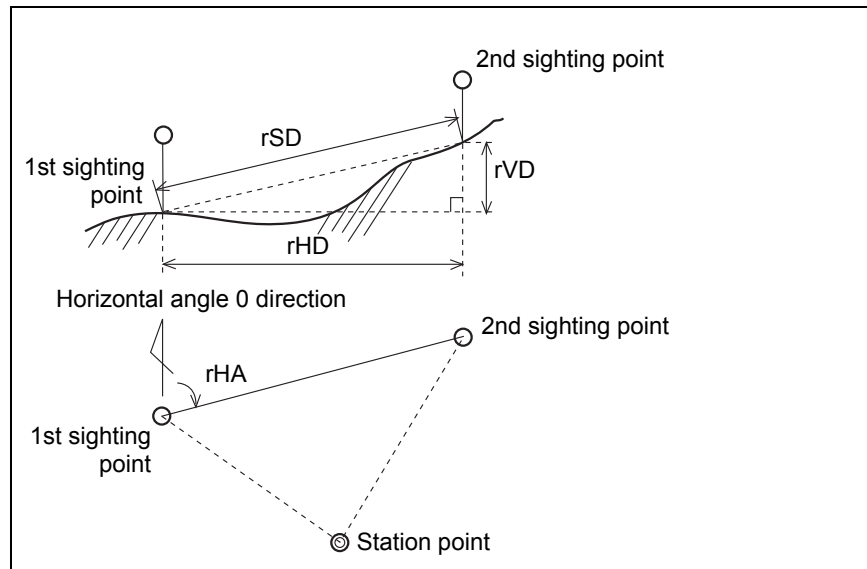

rSD	Slope distance between two points
rHD	Horizontal distance between two points
rVD	Vertical distance between two points
rV%	Percentage of grade $(rVD/rHD) \times 100\%$
rGD	Vertical grade $(rHD/rVD) :1$
rAZ	Azimuth from first point to second point

Measuring between the current and the first point measured

- To enter the RDM (Radial) function, press **[3]** or select RDM(Radial) in the *Programs* menu.
- Sight the first point and press **[MSR1]** or **[MSR2]**.

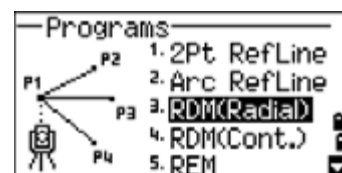

The distance from the station point to the first point appears.

- Sight the second point and press **[MSR1]** or **[MSR2]**. The distances between the first and second point are displayed.

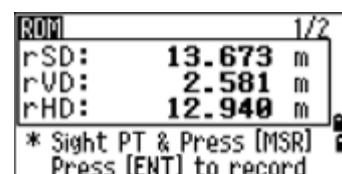

rSD	Slope distance between two points
rVD	Vertical distance between two points
rHD	Horizontal distance between two points

- To change display screens, press **[DSP]**.

rAZ Azimuth from first point to second point
 rV% Percentage of grade (rVD/rHD) × 100%
 rGD Vertical grade (rHD/rVD) :1

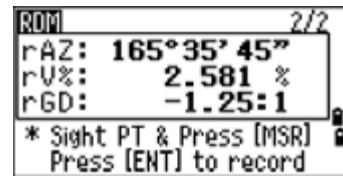

- To record the distance and angle information as a comment record, press **[ENT]** in the 1/2 or 2/2 observation screen.

Default point numbers are displayed. You can change these point numbers. To record a note, press **[ENT]** in the To field.

Data that you save in RDM functions is stored in RM records. For more information, see [RM records, page 114](#). When you download data in Nikon RAW format, they are output as comment (CO) records.

Measuring between the current point and the immediately preceding point

- To enter the RDM (Continuous) function, press **[4]** or select **RDM(Cont.)** in the *Programs* menu.
- Follow the procedure as for a radial RDM measurement. For more information, see [Measuring between the current and the first point measured, page 75](#).

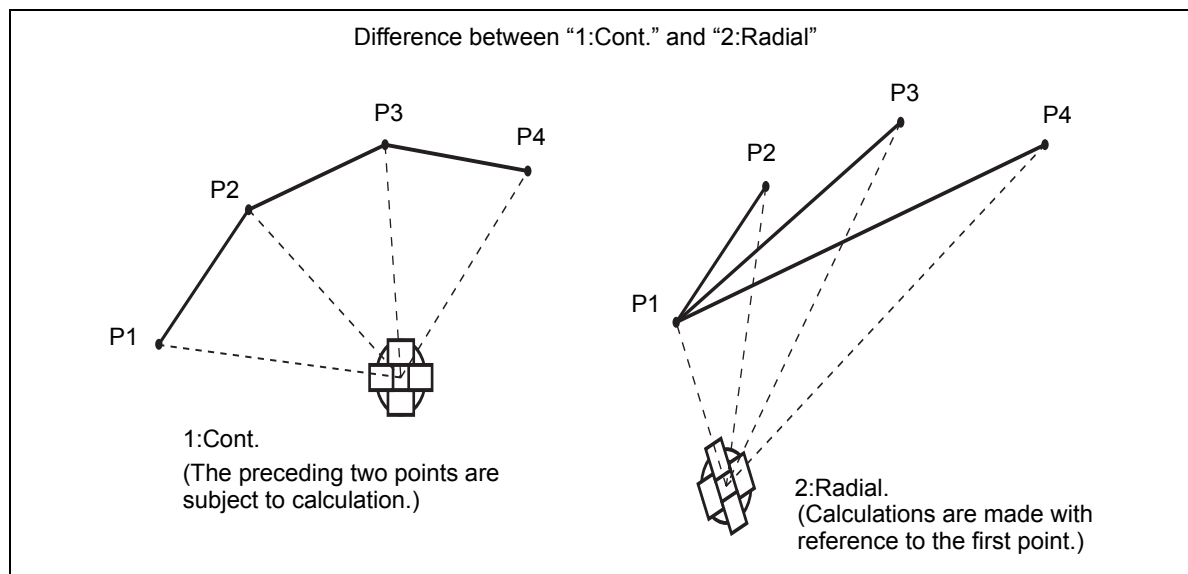
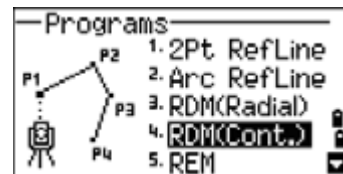

Measuring remote elevation

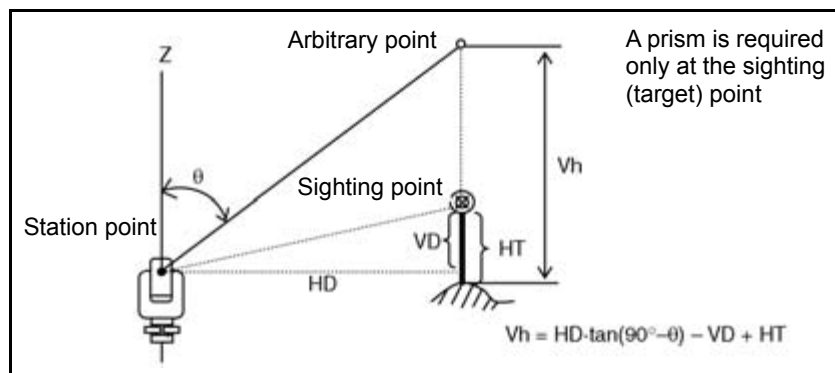

1. To enter the Remote Elevation Measurement function, press **[5]** or select **REM** in the *Programs* menu.
2. Enter the height of target.
3. Sight the target point and press **[MSR1]** or **[MSR2]**.
4. Loosen the vertical clamp, and turn the telescope to aim at an arbitrary point.

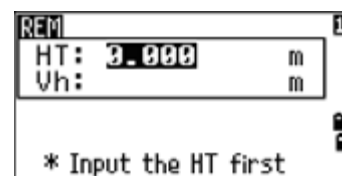
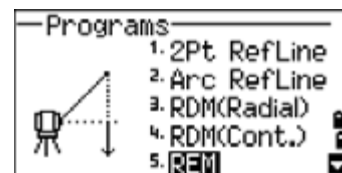

The difference in elevation (V_h) appears.

You can use an REM measurement to update the height of target. Take a measurement to the prism, sight the bottom of the prism pole, and press **[ENT]**.

Measuring distance and offset values on the vertical plane

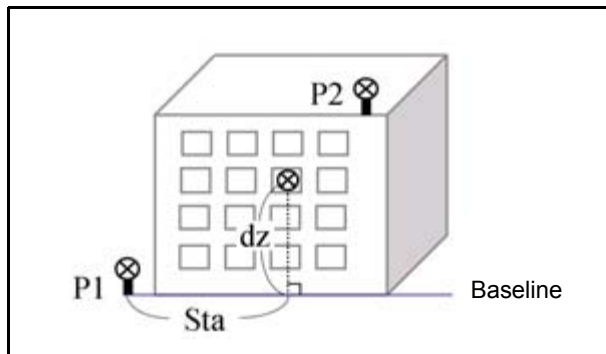

1. To enter the 2-Pt Reference Plane function, press **[6]** or select **V-Plane** in the *Programs* menu.

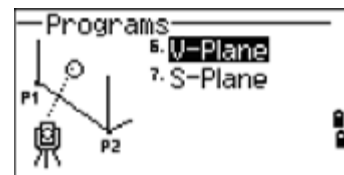

2. Enter two points to define the plane.

To enter the point by direct measurement, press the **MSR PT** softkey.

When you press the **MSR** softkey, a temporary observation screen appears.



3. Press **[MSR1]** or **[MSR2]**. The *Record PT* screen appears.
4. Enter a value in the *PT* and *CD* fields. Press **[ENT]**.
5. Enter the second point on the vertical plane. Press **[ENT]**.

Once the plane is defined, the calculated *Sta* and *dZ* values are updated as you move the telescope. No distance measurement is required.

Sta Horizontal distance from P1 to the target point along the baseline
dZ Vertical distance from P1 to the target point

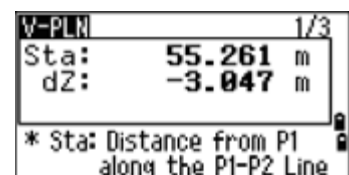

Using DSP to switch between display screens

Press DSP to switch between the plane display screens. The following screens are available:

PLN1	PLN2	PLN3
Sta dz	X Y Z	HA VA

Every time you press DSP, the next screen appears. If you press DSP in the last screen (PLN3), the PLN1 screen appears.

To record the point, press ENT on any screen (V-PLN1/3 to V-PLN3/3).

Enter PT and CD. Then press ENT.

Sample records

CO,Vertical Ref Plane Pt1:516-A1 Pt2:530

CO,Sta=68.021 dz=17.459

SS,30123-A48,1.5480,16.4020,40.4720,89.0730,14:22:47,

Measuring distance and offset values on the slope

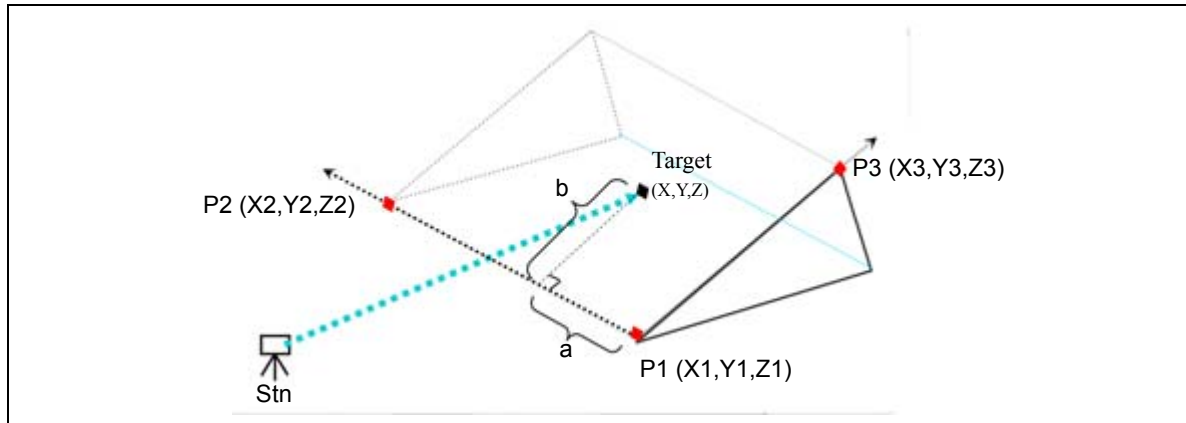

1. To enter the 3-Pt Reference Plane function, press $\boxed{7}$ or select **S-Plane** in the *Programs* menu.

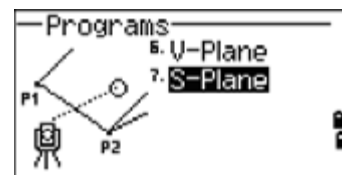

2. Enter three points to define the slope plane. To enter the point by direct measurement, press the MSR softkey.

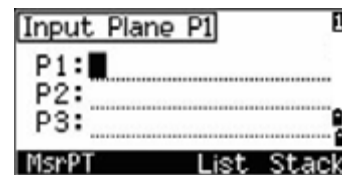

If you press \boxed{ENT} in a blank field, an input screen for temporary coordinates appears. These coordinates will not be stored.

When you have entered the temporary coordinates, $\langle \text{Keyed-in XYZ} \rangle$ appears instead of the PT name.

If the plane is defined by two points (by selecting **2Pt**), the vertical plane is the same as the plane used in the V-Pln function, but the indicating factors are Sta and dZ, not a and b. For more information, see [Measuring distance and offset values on the vertical plane, page 78](#).

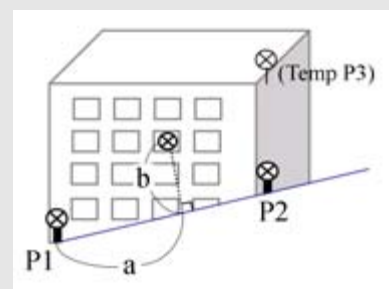

Once the plane is defined, the calculated a and b values are updated as you move the telescope. No distance measurement is required.

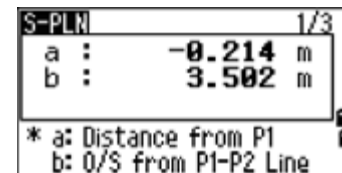

- a Distance between P1 and the point that is perpendicular to the target point along the P1-P2 line
- b Length of the perpendicular line from the target point to the P1-P2 line

Using **[DSP]** to switch between display screens

Press **[DSP]** to switch between the plane display screens. The following screens are available:

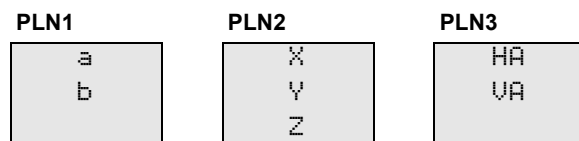

Every time you press **[DSP]**, the next screen appears. If you press **[DSP]** in the last screen (PLN3), the PLN1 screen appears.

To record the point, press **[ENT]** on any screen (S-PLN1/3 to S-PLN3/3).

Enter *PT* and *CD*. Then press **[ENT]**.

Sample records

CO,3ptPlane P1:1062 P2:2902 P3:1547

CO,a=31.497 b=14.239

SS,30123-A49,1.6110,0.0000,234.3210,86.0955,16:07:18,

Recording Measurement Data

Recording data from any observation screen

To record points on observation screens, press **[ENT]**.

PT defaults to the last recorded PT + 1.

You can enter the PT name from the point list or the point stack. For more information, see [Entering a point from the point list, page 45](#), and [Entering a point from the stack, page 45](#).



You can also use the code list or the code stack. For more information, see [Entering a code from the code list, page 46](#), and [Entering a code from the stack, page 45](#).

To record the point, press **[ENT]** on the last field.

When recording sideshots, stakeout records and control shots from the Rept function, you can choose to store raw data only, XYZ data only, or both. For more information, see [Recording, page 110](#).

If HA or VA is moved after you take a measurement but before you press **[ENT]**, the angle recorded is the angle shown when **[ENT]** is pressed.

In an angle-only record, SD is always recorded as 0.0000.

If the point name that you want to record already exists in the job, an error message appears. Depending on the type of existing record, you can overwrite the old record with the new data. For more information, see [Recording Data, page 165](#).

Hold down **[ENT]** for one second to record the measurement as a CP record.

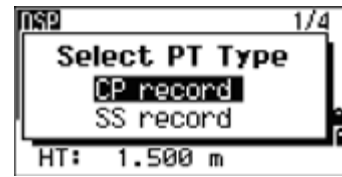

Outputting data to the COM port

If you press **[ENT]** while the **[COM]** icon appears in an observation screen, a line of data is output to the COM port.

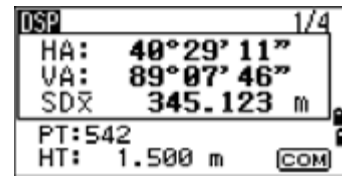

Note – If **[COM]** appears, data is **not** stored to the job when you press **[ENT]**.

The format of the output data is defined by the setting of the *Ext.Comm* field in MENU > Settings > COMM. For more information, see [Communications, page 109](#).

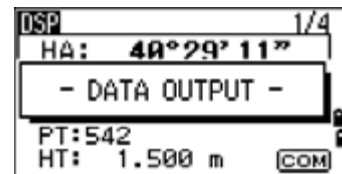

To output data on the COM port when you press **[ENT]**, set the Data Rec field in MENU > Settings > Rec to COM. For more information, see [Recording, page 110](#).

Sample output records through COM port

When the Ext.Comm field is set to NIKON:

TR PN: PT8 SD:000066626 HA:003856010 VA:008048500 HT:0000061757
(TR PN: point name SD HA VA HT; when ACK is returned, PN is incremented.)

When the Ext.Comm field is set to SET:

0006662 0804806 0394324 97
(SD VA HA Chk-SUM)

Measuring Offsets

Measuring taped offsets

- To enter the taped offset function, press **[F1]** or select **Tape** in the *Offset* menu.

If you have not taken a distance measurement before entering this function, a temporary measurement screen appears.
- Sight the target and press **[MSR1]** or **[MSR2]**.
- Enter offset distances from the measured point. Use **[↑]** or **[↓]** to move to the appropriate offset field.

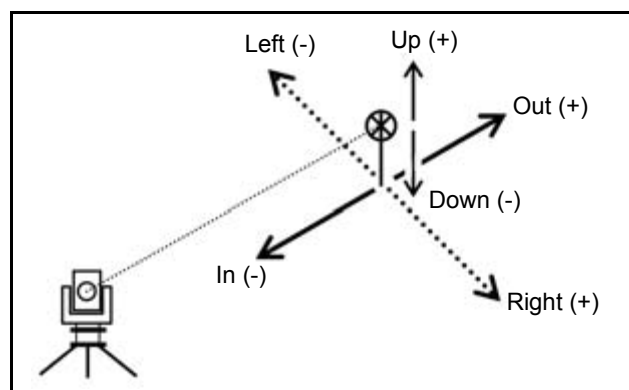
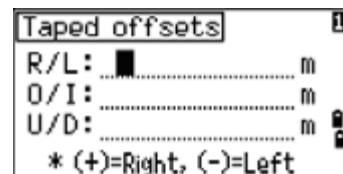
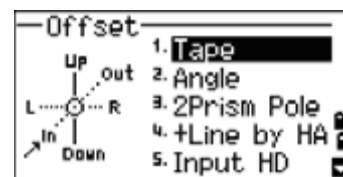

You can enter any combination of taped offset distances to specify the point.

- To go to the recording PT screen, press **[ENT]** in the last field.
The calculated coordinates are shown.
- Enter a PT (and CD) value.
- Press **[ENT]** to record the point.
Raw data is also recalculated, based on the taped offset value.

Measuring angle offsets

1. To enter the angle offset function, press **[2]** or select **Angle** in the *Offset* menu.

If you have not taken a distance measurement before entering this function, a temporary measurement screen appears.

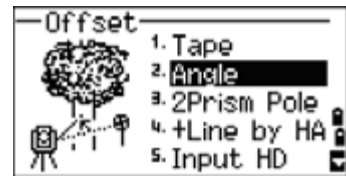

2. Sight the target and press **[MSR1]** or **[MSR2]**.
3. To take the angle offset, rotate the alidade and telescope. The measured distance (HD) remains unchanged.
4. To record the offset point, press **[ENT]** or the **OK** softkey.

The XYZ data is also recalculated, based on the new angle.

You can record an angle offset in the Basic Measurement Screen (BMS). After taking a distance measurement, rotate the alidade and/or telescope. Then press **[ENT]** to record the measured distance with the updated angle value. If you use this method, the dimension of the angle offset is not stored as a CO record. To store the CO record, use the O/S function.

Two-prism pole

1. To enter the two-prism pole function, press **[3]** or select **2Prism Pole** in the *Offset* menu.

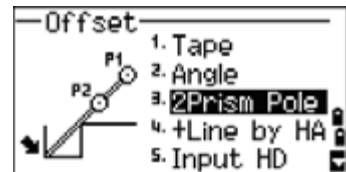

2. Sight the first prism and press **[MSR1]** or **[MSR2]**.
3. Sight the second prism and press **[MSR1]** or **[MSR2]**.

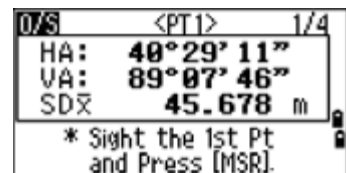

4. Enter the distance between the second prism and the target point. Alternatively, if you do not need QA information, you can leave the distance between the first and the second prism blank.

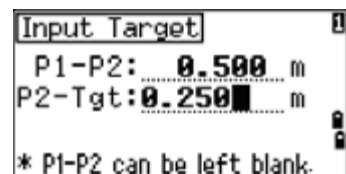

5. If you do enter a P1-P2 distance, the QA screen appears. Compare the entered value and the measured distance to check the accuracy of the observation.

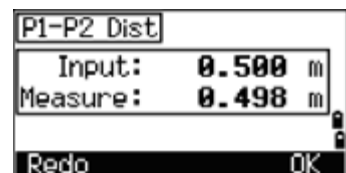

6. To record the point, press **[ENT]** or the **OK** softkey.

Sample records

SS,14,0.0000,38.9200,271.0350,89.2630,11:04:15,DITCH
CO,2Prism O/S: P1-P2= 0.5090(0.5060) P2-Tgt= 0.5020

Note – In this sample data, 0.5090 is the measured value. 0.5060 is the entered value.

Extending a line by horizontal angle offset

- To enter the line extension (by HA) function, press **[4]** or select **+Line by HA** in the *Offset* menu.
- Sight the first prism (or target) and press **[MSR1]** or **[MSR2]**.

The display moves to the next screen.

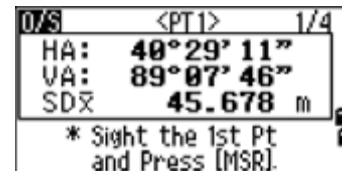
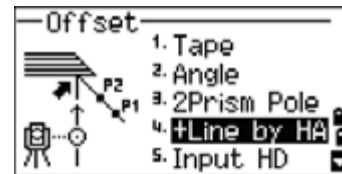
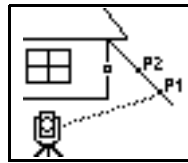

- Sight the second prism (or target) and press **[MSR1]** or **[MSR2]**.

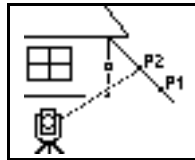

- Sight the alternative place on the same vertical line as the required target point.

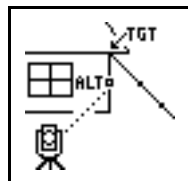

- To calculate the coordinates and the raw data of the target point, press **[ENT]**.
- To record the point, enter a PT (and CD) value and press **[ENT]**. The height of target is fixed to 0.0000 for the offset point.

Sample records

SS, 40, 0.0000, 48.3304, 169.20370, 82.02470, 10:52:37

CO, PT1, 0.0000, 48.3020, 169.19165, 83.58565

CO, PT2, 0.0000, 48.3155, 168.54250, 85.42440

CO, O/S MSR:40 0.0000 0.0000 169.20370 87.02340

The calculated point (TGT) is stored as a SS record.

Measurements to the first and second target (P1 and P2) are stored as comment records (PT1 and PT2). The last record records the angle measurement to the ALT (vertically offset point from the actual target point).

Entering a horizontal distance after an angle-only shot

This function is useful when the instrument is very close to the point and it is difficult to take a measurement using the EDM.

1. To enter the Input HD function, press **[5]** or select **Input HD** in the *Offset* menu.

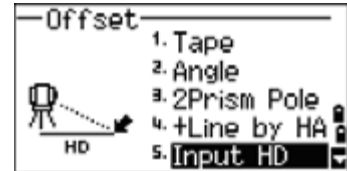
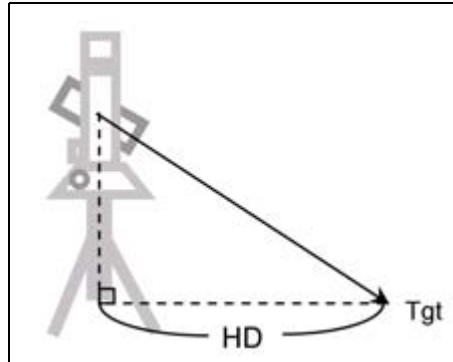

2. Turn the telescope in the direction of the point that you want to store.
3. Enter the HD. Usually this is the taped distance from the instrument point.
4. Enter a PT (and CD) value and press **[ENT]**.

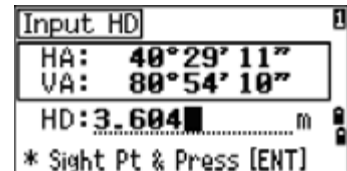

The target point is calculated and recorded as an SS record.

Sample records

SS,158,0.0000,77.0518,62.08380,108.06510,11:51:48,
CO, Input HD:76.1243

Calculating a corner point

1. To enter the corner point function, press **[6]** or select **Corner** in the *Offset* menu.
2. Take a distance measurement to the first prism (or target) on the wall. Press **[MSR1]** or **[MSR2]**.
3. Sight a second point on the same wall with the first point measurement. Press **[MSR1]** or **[MSR2]**.

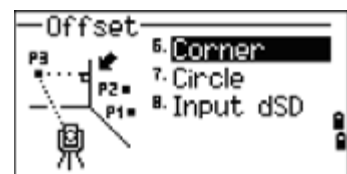
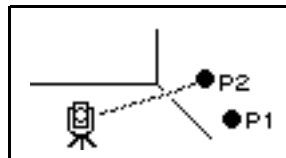

4. Sight the first point on the second wall. Press **[MSR1]** or **[MSR2]**.

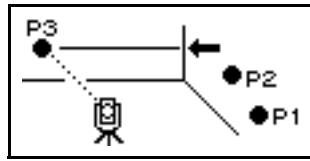

5. If the two walls are at right angles, press the **[CALC]** softkey to calculate the corner point by three points.
6. If you take a measurement to a fourth point, the corner point can be calculated as the intersection of two walls (P1-P2 and P3-P4). The default elevation is given by P4.

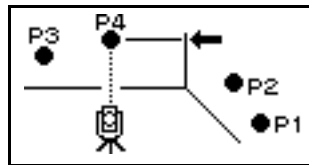

7. Enter a PT (and CD) value. The height of target (HT) defaults to the value used in the last measurement.
8. To record the corner point, press **[ENT]**.

Sample records

SS, 58, 0.0000, 48.3304, 169.19165, 82.02470, 10:52:37, FLOOR2

CO, PT1, 1.0080, 48.3020, 169.19165, 83.58565

CO, PT2, 1.0080, 48.3155, 128.54250, 85.42440

CO, O/S MSR:40 0.0000 0.0000 169.20370 87.02340

The calculated corner point is stored as an SS record.

The next three or four comment records are measured points. For example:

CO, Point name (fixed to PT1, PT2 etc.), HT, SD, HA, VA.

Measuring circle offsets

1. To enter the circle center calculation function, press $\boxed{7}$ or select **Circle** in the *Offset* menu.

If you have not taken a measurement to the circle before entering this function, a temporary measurement screen appears.

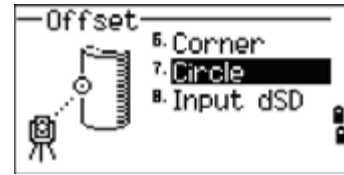

2. Sight any point on the surface of the circle and press $\boxed{\text{MSR1}}$ or $\boxed{\text{MSR2}}$.

If you use a prism attached to the surface of the circle for the distance measurement, press the $\boxed{+SD}$ softkey to eliminate the offset error (from the attached point to the measured surface of the prism) before you press $\boxed{\text{ENT}}$.

3. Sight one edge of the circle and press $\boxed{\text{ENT}}$.

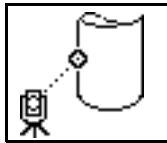

If you have taken a distance measurement to the center of the circle, press the $\boxed{\text{Calc}}$ softkey to calculate the offset using one edge angle observation.

4. Sight the other edge of the circle and press $\boxed{\text{ENT}}$.

The instrument calculates and records the center of the circle. It also calculates the coordinates of the center point and the radius of the circle

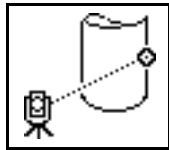

5. To record the point, press $\boxed{\text{ENT}}$ or the $\boxed{\text{OK}}$ softkey.

Sample records

```
SS,71,1.5000,37.0518,32.08380,81.06510,11:51:48,
CO, PT1, 0.0000, 0.0000,47.05350, 83.58560
CO, PT2, 0.0000, 0.0000, 29.53010, 83.58560
CO,O/S MSR:71 1.5555 36.5418 38.28360 81.06510
CO,Radius of circle 0.356
CO,Input +SD:0.0020
```

The calculated point (center of the circle) is stored as an SS record.

The following one or two comment records are angle-measured points. For example:

```
CO, Point name (fixed to PT1/ PT2), HT(0.0000), SD(0.0000), HA, VA.
```

If you press the $\boxed{+SD}$ softkey before you sight Edge1, the input value is recorded at the end.

Extending the slope distance

1. To enter the function for extending the slope distance, press **[8]** or select **Input dSD** in the Offset menu.

If you have not taken a distance measurement before entering this function, a temporary measurement screen appears.

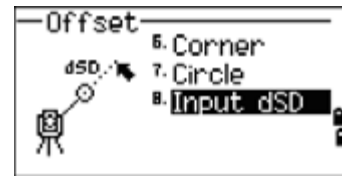

2. Enter the slope distance that you need to add or subtract. You can enter any value from -99.990 through $+99.990$ m (-328.000 through $+328.000$ ft).
3. To record the point, press **[ENT]**.

Sample records

SS,83,1.5000,77.0518,62.08380,81.06510,11:51:48,
CO,O/S MSR:83 1.5555 76.5518 62.08380 81.06510

Menu Key

In this chapter:

- Job Manager
- Cogo
- Settings
- Data
- Communication
- 1sec-Keys
- Calibration
- Time
- Removable Memory (USB Memory)

Use the MENU screen to access important functions and settings.

To display the MENU screen, press the  key.



Job Manager

Use the job manager to open, create, delete, and manage jobs. To open the Job Manager, press **[T]** or select **JOB** on the *MENU* screen.

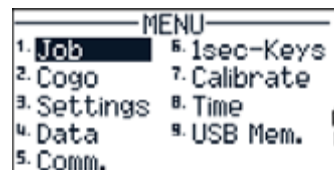

If there are jobs stored on the instrument, the job list appears, showing all the stored jobs. The newest job appears at the top of the list.

If there are no jobs stored, the *Create Job* screen appears. See [Creating a new job](#), page 92.

Opening an existing job

The job list shows all the jobs stored on the instrument, in descending date order.

The following symbols may be used to provide extra information about jobs:



Symbol	Meaning
*	Current job.
@	Control job.
!	Some of the job settings are different from the current job.
?	Job was created in an older DB. Older files cannot be opened in version 1.10 or later of the software.

Press **[^]** or **[v]** to move up or down the job list. Press **[ENT]** to open the highlighted job.

When you open a job, all job settings are automatically changed to match those used in the open job.

Creating a new job

1. Press the **Cr eat** softkey in the job list.
2. Enter a job name of up to eight characters. Press **[ENT]**.
3. Do one of the following:
 - To check the job settings, press the **Set t** softkey.
 - To create a new job using the current job settings, press **[ENT]** or the **OK** softkey.

Job settings

The following settings are set when a job is created, and cannot be changed. This ensures that the data in a job is correctly stored in the database, and that all necessary corrections are applied when you store each record.

<Job Sett 1/3>

Scale Factor	0.999000 to 1.001000
T-P correction	ON/OFF
Sea Level	ON/OFF
C&R correction	OFF/0.132/0.200

<Job Sett 2/3>

Angle unit	DEG/GON/MIL
Distance unit	Metre/US-Ft/I-Ft

If you select US-Ft or I-Ft, an additional settings screen appears. Use this screen to specify whether to display values in Decimal-Ft or Ft-Inch.

Temp unit	°C/°F
Press unit	hPa/mmHg/inHg

<Job Sett 3/3>

VA zero	Zenith/Horizon/Compass
AZ zero	North/South
Order	NEZ/ENZ
HA	Azimuth/0 to BS

To move between fields, press \uparrow or \downarrow . Alternatively, to move to the next field, press ENT .

To change the setting in the selected field, press \leftarrow or \rightarrow .

To confirm the job settings and create the job, press ENT in the last field (HA).

These settings are separate from other temporary settings.

Deleting a job



CAUTION – There is no undelete function in the Job Manager. Before you press ENT or select DEL , make sure that the selected job is the one that you want to delete.

1. In the job list, highlight the job that you want to delete.
2. Press the DEL softkey. A confirmation screen appears.
3. Do one of the following:
 - To delete the selected job, press ENT or the DEL softkey.
 - To cancel the deletion and return to the previous screen, press ESC or the ABRT softkey.

After you delete a job, the display returns to the job list.

Setting the control job

If you search for a point when a control job is specified, and the system cannot find the point in the current job, the control job is also searched. If the point is found in the control job, it is copied to the current job as a UP record.

A control job has the same format as a standard job. You can open and modify it like any other job, and you can use it to record any measured data.

To set the control job:

1. Highlight the job that you want to use.
2. Press the **FNC** softkey.
A confirmation screen appears.
3. Do one of the following:
 - To set the selected job as the control job, press **ENT** or the **YES** softkey.
 - To cancel the process, press **ESC** or the **NO** softkey.

If a control job is already assigned, the newly assigned control job replaces it as the control job.

To clear the control job selected, highlight the current control job in the job list and press the **Ctrl** softkey. Then press **ENT** or the **YES** softkey to confirm.

Displaying job information

To display job information, highlight the job name and then press the **Info** softkey.

The *Information* screen shows the number of records in the job, the free space, and the date when the job was created. Free space indicates how many points can be stored in the job.

To return to the job list, press any key.

Importing a job

To import a job from the USB memory stick to the instrument:

1. In the job list press the **FNC** softkey. The *FNC* screen appears.
2. Press **2** or press **v** to move the highlight to *Import Job (USB->Inst.)* and then press **ENT**. The *USB Memory (Job)* screen appears. This screen displays the job list from the detachable memory.

Note – To change the way in which the list is ordered (job name or created date), select the **DISP** softkey.

3. Press **v** to move the cursor to the job that you want to copy and press **ENT**.
4. Verify the job name and then select the **YES** softkey to copy the job to the instrument. If the job contains a lot of records, the process may take a long time. A progress bar appears.

Select **NO** to cancel the process.

5. When the job has been copied, do one of the following:
 - To start working on the job immediately, select **YES**.
 - To return to the menu screen, select **ABRT**.

Exporting a job

If you want to keep a job file for future use, you can export the job file to a USB memory stick.

To export a job:

1. Highlight the job that you want to export to the external memory device.
2. Press the **FNC** softkey. The *FNC* screen appears.
3. Press **3** or press **▽** to highlight Export Job (Inst.->USB) and then press **ENT**. The *Export Job* screen appears.
4. Verify the job name and then select the **YES** softkey to export the job to the memory storage device. If the job contains many records, the process may take a long time. A progress bar appears.

Select **NO** to cancel the process.

Do NOT remove the external memory device (USB memory stick) while the progress bar is displayed.

5. When the job export is complete, the *Delete JOB* screen appears. Do one of the following:
 - To delete the job, select **DEL**.
 - To cancel the process, select **ABRT**.

Cogo

Use the *Cogo* menu to perform coordinate geometry (COGO) calculations. You can access this menu at any time from any observation or PT input screen.

To open the Cogo menu, press **[2]** or select **COGO** on the *MENU* screen.

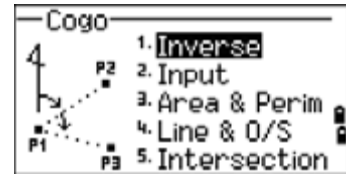

Calculating angle and distance between two coordinates

To open the *Inverse* menu, press **[1]** or select **Inverse** in the *Cogo* menu.

PT-PT inverse

PT-PT calculates the distance and the angle between two input points.

To calculate a PT-PT inverse:

1. Press **[1]** or select **PT-PT** in the *Inverse* menu.
2. The *Input P1* screen appears. Enter the first point number or name. Press **[ENT]**.

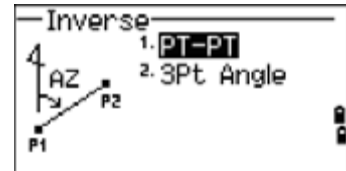

If you press **[ENT]** without entering a point name, a coordinate input screen appears, and you can enter coordinates. These coordinates are **not** stored to the database. If you want to store the point, specify a new point name.

3. The *Input P2* screen appears. Type the second point number/name and press **[ENT]**. The **MSR** softkey allows you to shoot the point on the spot to use it in the calculation.

The azimuth, horizontal distance, and vertical distance from the first point to the second point are displayed.

4. Do one of the following:
- To return to the PT input screen, press **[ESC]**.
 - To return to the COGO menu, press **[ENT]**.
 - To change the contents of the result screen, press **[DSP]**.

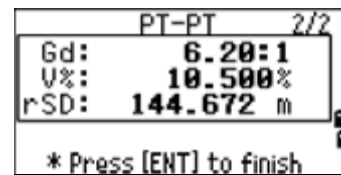

Gd Grade (HD/VD)
 V% 100/Gd
 rSD Slope distance PT1 to PT2

3Pt angle

The 3Pt Angle function calculates the angle between two lines defined by three points.

To calculate a 3Pt angle:

1. Press **[2]** or select **3Pt Angle** in the *Inverse* menu.

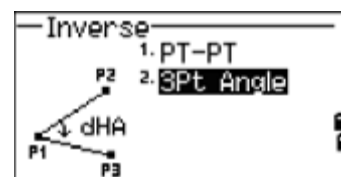

P1 is the base point. Two lines are to be defined by P2 and P3, both from P1.

2. The *Input BasePt* screen appears. Enter the point name, or use the **MSR** softkey to take a measurement to the point.
3. The *Input direction* screen appears. Enter the second point (P2) to define the baseline (P1-P2). The angle (dHA) is measured from the baseline.
4. Enter the third point (P3) to define the second line (P1-P3).

When you press the **MSR** softkey, a temporary measuring screen appears. Sight the target and press **[MSR1]** or **[MSR2]** to take a measurement.

After the measurement, a recording point screen appears. To store the measured point, enter the PT, HT, and CD values and press **[ENT]**. To use the point without recording it, press **[ESC]**.

When you have entered three points, the instrument calculates the angle and distances.

5. Do one of the following:
 - To return to the *Inverse* menu, press **[ENT]**.
 - To return to the *Input BasePt* screen, press **[ESC]**.

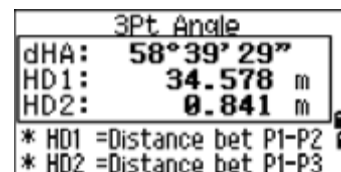

Calculating and manually inputting coordinates

To enter the Input menu, press **[2]** or select **Input** in the *Cogo* menu. There are three functions in this menu for recording new coordinate points.

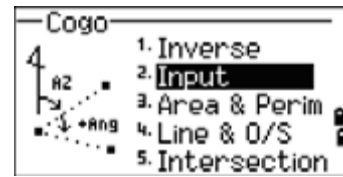

Azimuth+HD input

- To calculate a coordinate by an angle and distance input from the base point (P1), press **[1]** or select **AZ+HD** in the *Input* menu.
- The *Input P1* screen appears. Enter the base point (P1). Type the point name and press **[ENT]**.
- The *Input AZ* screen appears. Enter the azimuth, horizontal distance, and vertical distance. Then press **[ENT]**.

To enter 123°45'45", type 123.4545 and press **[ENT]**.

- The *Input dVD* screen appears. If you do not enter a value in the dVD field, the value 0.000 is used.

A recording point screen with the calculated coordinates appears. PT defaults to the last recorded PT + 1.

- Press **[ENT]** to store the point.

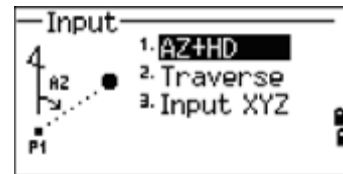

Traverse

- To open the Traverse (2Pt Angle) function, press **[2]** or select **Traverse** in the *Input* menu.

Traverse function calculates a new point based on the two defined points and angle, horizontal and vertical distances from the line defined by those two points.

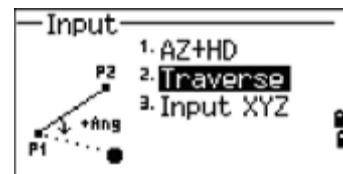

- The *Input P1* screen appears. To enter P1 and P2, enter point names or take measurements to targets.
- The *Input dVD* screen appears. Enter the plus-minus angle, horizontal distance, and vertical distance from the baseline defined by P1-P2.

If you do not enter a value in the dVD field, the value 0.000 is used.

- When you press **[ENT]** in the dVD field, a new point is calculated. The PT name defaults to the last recorded PT + 1.
- To record the new point and return to the point input screen, press **[ENT]**.

P1 (base PT) defaults to the previously recorded PT. P2 defaults to the previous P1.

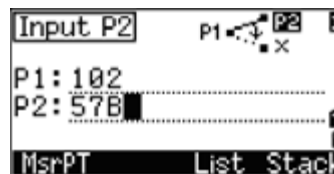

To continuously calculate a new point, enter +Ang, HD, and dVD from the previous bearing line. This is a convenient way to enter Traverse points.

Entering coordinates

To manually enter the XYZ coordinates, press **[3]** or select **Input XYZ** in the *Input* menu.

The PT name defaults to the last recorded PT + 1.

Enter the coordinates using the numeric keys. To move to the next field, press **[ENT]** or **[v]** in a field

To store the point as an MP record and return to the point input screen, press **[ENT]** in the Z field. The default PT is incremented to the next value.

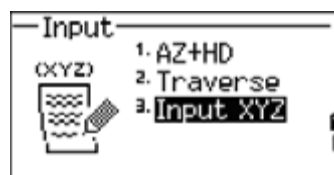

You can record NE, NEZ, or Z-only data to the database.

Calculating area and perimeter

- To calculate an area or perimeter, press **[3]** or select **Area & Perim** in the *Cogo* menu.
- To take a measurement, enter the first point and press **[ENT]**, or press the **MSR** softkey.
- In the upper right corner of the screen, a counter indicates how many points you have entered.

To input point numbers consecutively, use the **Fr/To** softkey. For more information, see [Advanced feature: Entering a range of points, page 100](#).

- If you enter a new point name, you can enter new coordinates and record the point. If you do not want to record the point, press **[ENT]** without entering a value in the PT field. An XY coordinate input screen appears.
- Continue to enter points until you have defined all the points in the lot. Then, press **[v]** to calculate the area and perimeter.

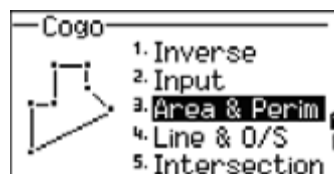

The first and last points that you enter are joined to close the area.
You must enter the points in the order in which they define the lot.
You can enter up to 99 points.

6. Press **[ENT]** to store the calculated values as a comment record, or press **[ESC]** to return to the Cogo menu.
7. If you chose to store the area, enter a name to identify the area and then press **[ENT]**.

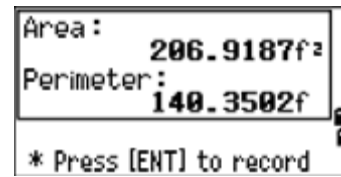

When you download data in Nikon RAW format, area (AR) records are output as comment (CO) records.

Advanced feature: Entering a range of points

To quickly enter a sequential range of points, use the range input function. To access this function, press the **Fr/To** softkey in the No. 01 or No. 02 input screens.

Enter the start point name in the *Fr* field and the end point name in the *To* field. You can include letters and hyphens in the point names, but the last character must be numeric.

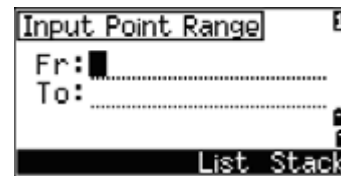

Press **[ENT]** in *To* field to start searching for matching points. The counter shows the number of matching points found.

When the search is complete, you are returned to the *Input PT* screen.

Press the **Calc** softkey to calculate the area and perimeter, or enter point names in the *PT* field.

Press **[ESC]** to return to the *Input PT* screen with the preceding point name.

Calculating coordinates from line and offset

To enter the Line & offset function, press **[4]** or select **Line & O/S** in the *Cogo* menu.

The *Input P1* screen appears. Enter the base point (P1).

Specify the azimuth bearing. To do this, enter a value in the *AZ* or *P2* field. P2 is a second point on the line.

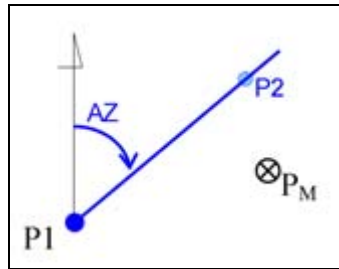

Enter the horizontal distance along the baseline (*Sta*), the horizontal distance perpendicular to the line (*O/S*), and the vertical distance (*dVD*).

A negative value in the *Sta* field means the opposite direction along the defined bearing line.

A negative value in the *O/S* field is for the left-hand side of the bearing line.

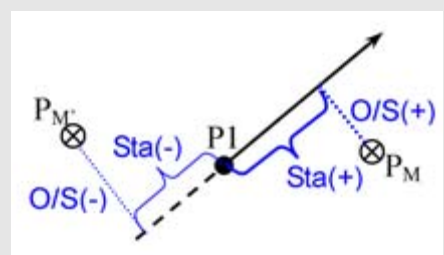

To calculate the coordinates of the point (PM), press **[ENT]** in the *dVD* field. You can change the *Z* coordinate here.

To record the point, press **[ENT]** in the *CD* field.

The coordinates are stored as a *CC* record. Line definition information and *Sta*, *O/S*, and *dVD* values are stored in comment (*CO*) records.

Calculating coordinates using intersection functions

To enter the Intersection menu, press \square or select **Intersection** in the *Cogo* menu. There are four functions in this menu for calculating coordinates.

Calculating a bearing-bearing intersection

A bearing-bearing intersection is the intersection point of two lines.

- To calculate a bearing-bearing intersection, press \square or select **Brng-Brng** in the Intersection menu.
- The *Input P1* screen appears. Enter the first point name and press \square . Alternatively, to measure directly to the point, press the **MSR** softkey.
- The *Input AZ* screen appears. Define the first line by azimuth.
- To define the line by two points, press the **Pts** softkey. The *Fr* field defaults to the P1 point, but you can change the selected point. In the *To* field, enter or measure to the second point.

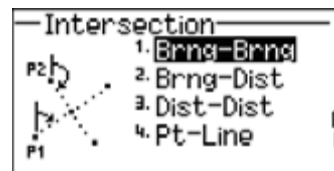

For more information about the \square softkey, see [Advanced feature: Entering angle and distance offsets, page 105](#).

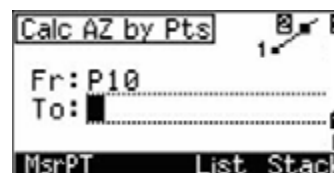

- Do one of the following:
 - To return to the previous screen, press \square . The calculated value appears in the *AZ* field.
 - To go to the next screen, press \square .
- Define the second line by two points or by P2 and *AZ*.
- To calculate the coordinates of the intersection point, press \square in the *AZ* field. The calculated coordinates are displayed. You can input a *Z* coordinate if necessary.
- Enter a value in the *PT* field and in the *CD* field.
- To record the point, press \square .

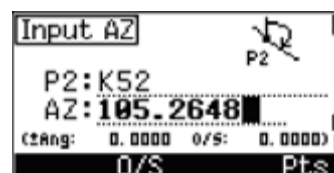

Sample records

```
CO,Int BB P1:P10 AZ:330.54175-90.00000
CO, P2:408 AZ:100.0000+0.0000
CC,A123,,4567.3080,200.1467,-1.2056,POT
```

Calculating a bearing-distance intersection

1. Press **[2]** or select **Brng-Dist** in the Intersection menu.

Brng-Dist calculates the intersection point formed by one line and one distance (radius).

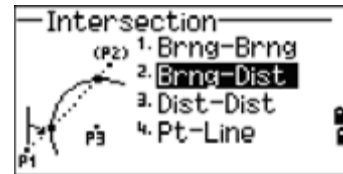

2. The *Input P1* screen appears. Enter a point on the line.

The line can be defined by two points or by a point and an azimuth.

3. The *Input P2* screen appears. Enter the second point (P2) as the center of the circle.
4. The *Input HD* screen appears. Enter the distance from P2.
 - To define the distance (HD) by two points, press the **Ft** softkey.
 - To calculate the coordinates of the intersection point, press **[ENT]** in the *HD* field.

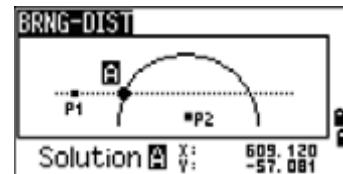

5. If there are two results, the first solution appears graphically relative to the P1-P2 line. To display the second solution, press **[<]** or **[>]**.
6. To record the point, press **[ENT]** when the required solution appears.
7. Enter a Z coordinate if necessary.
8. To move to the *PT* and *CD* fields, press **[ENT]**.

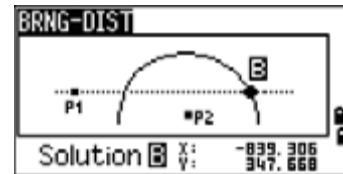

Sample records

CO,Int BD P1:4672 AZ:330.54175+0.00000
 CO, P2:71 HD:100.0000
 CC,504,,-839.3065,347.6682,,SIGN

Calculating a distance-distance intersection

1. Press **[3]** or select **Dist-Dist** in the *Intersection* menu.
2. The *Input P1* screen appears. Enter the first point name and press **[ENT]**, or press the **MSR** softkey to measure directly to the point.
3. The *Input HD* screen appears. Enter the distance from P1 and press **[ENT]**.
4. To define the distance (HD) by two points, press the **Ft** softkey.
5. Enter *P2* and the distance from P2 (*HD*).
6. To calculate the coordinates of the intersection point, press **[ENT]** in the *HD* field.

7. Press \leftarrow or \rightarrow to display the second solution.
8. To record the point, press ENT when the required solution appears.
9. Enter a Z coordinate if necessary. Press ENT to move to the PT and CD fields.

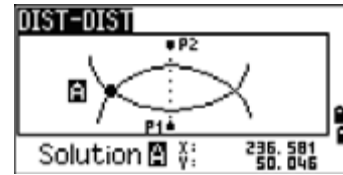

Sample records

CO,Int DD P1:486 HD:330.6020
 CO, P2:7 HD:100.0000
 CC,505,,236.5817,50.0461,0.0000,

Calculating a point-line intersection

1. Press 4 or select Pt-Line in the *Intersection* menu.
2. The *Input P1* screen appears. Enter the first point name and press ENT , or press the MSR softkey to measure directly to the point.
3. The *Input AZ* screen appears. Enter the azimuth, or press the Pt softkey to enter another point name on the line.
4. The *Input P2* screen appears. Enter the perpendicular point to the line, or press the MSR softkey to take a measurement to the point.
5. To calculate the coordinates of the intersection point, press ENT .

If $P1$ and $P2$ are 3D points, the Z coordinate of the perpendicular point is calculated relative to the $P1$ - $P2$ slope.

6. Enter PT and CD then press ENT to record the point.

Sample records

CO,Int PtLine P1:38 AZ:90.00000+0.00000
 CO, P2:506
 CC,A-123,,4567.3080,200.1467,-1.2056,POT

Advanced feature: Entering angle and distance offsets

1. To display the offset input screen, press the O/S softkey.
2. In the *Ang* field, enter a positive value to rotate the line clockwise. Enter a negative value to rotate the line counterclockwise.

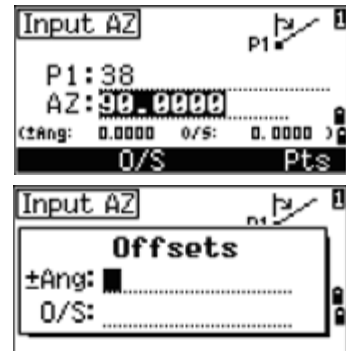
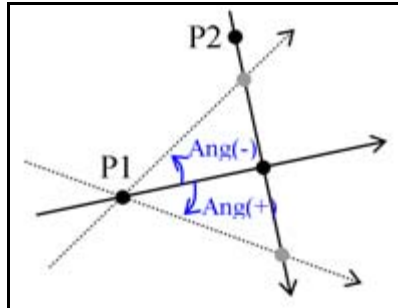

3. In the *O/S* field, enter a positive value to specify an offset to the right. Enter a negative value to specify an offset to the left.

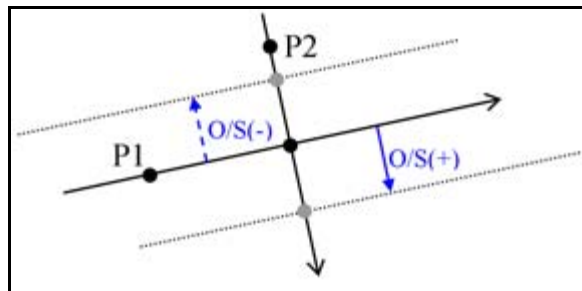

Settings

To display the Settings menu, press **[2]** or select **Settings** on the *MENU* screen.

Use this menu to configure the initial job settings.

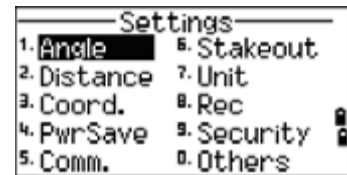

Some job settings, specified in the following sections, cannot be changed once a job is created. If any of these settings are changed while a job is open, a confirmation screen appears, asking you to create a new job with the new settings, or to work with those settings without recording any data. For more information, see [Settings, page 166](#).

Angle

To open the *Angle* menu, press **[1]** or select **Angle** in the *Settings* menu.

VA zero	Zenith/Horizon/Compass
Resolution	1"/5"/10" or 0.2 mgon/1 mgon/2 mgon
HA	0 to BS/Azimuth

The VA zero job setting cannot be changed once a job is created.

The HA job setting cannot be changed once a job is created.

When this field is set to Azimuth, the horizontal angle (HA) that appears and recorded is in Azimuth value. When this field is set to 0 to BS, HA is in HA zero to BS value.

Distance

To open the *Distance* menu, press [2] or select *Distance* in the *Settings* menu

Scale	Numeric value between 0.999000 and 1.001000
T-P corr.	ON/OFF
Sea Level	ON/OFF
C&R corr.	OFF/0.132/0.200

The Scale, T-P corr., Sea Level, and C&R corr. job settings cannot be changed once a job is created.

Temperature and Pressure corrections

SD	Slope dist. (before adj.)
SD'	Slope dist. (after adj.)
K	Compensation coefficient
P	Pressure (hPa)
T	Temperature (°C)

$$K = 275 - \frac{106 \times P \times \left(\frac{10000.0}{13.5951 \times 980.665} \right)}{273 + T}$$

$$SD' = \left(1 + \frac{K}{1000000} \right) \times SD$$

Sea Level correction

$$HD' = \frac{HD \times R_e}{R_e + Z_{STN}}$$

HD	Horizontal dist. (before adj.)
HD'	Horizontal dist. (after adj.)
Z_{STN}	Instrument-Z
R_e	6370 km

Curvature and Refraction correction

Because the surface of the earth is curved, the vertical difference (VD and Z) at the measurement point, as referenced to the horizontal plane, inevitably includes some error. This error is called **curvature error**. Also, because the density of the air

surrounding the earth decreases with altitude, light is refracted at different rates at different altitudes. The error caused by this change in refraction is called **refraction error**.

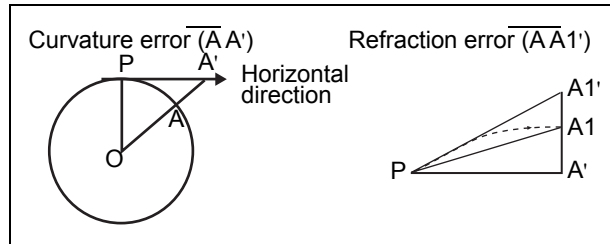

HD	Horizontal dist. (before adj.)
HD'	Horizontal dist. (after adj.)
VD	Vertical dist. (before adj.)
VD'	Vertical dist. (after adj.)
SD	Slope distance
VA	Vertical angle
Re	6370 km
k	C&R constant (0.132 or 0.200)

$$HD' = HD - \frac{SD^2 \sin(2VA)}{2R_e} \left(1 - \frac{k}{2}\right)$$

$$VD' = VD + \frac{HD^2}{2R_e} (1 - k)$$

Coordinate

To open the Coordinate menu, press **[3]** or select **Coord.** in the **Settings** menu.

Order	NEZ/ENZ
Label	XYZ/YXZ/NEZ(ENZ)
AZ	North/South

The Order and AZ job settings cannot be changed once a job is created.

Power saving

To open the Power Save menu, press **[4]**, held down **[AF]** for one second, or select **Power Save** in the *Settings* menu.

Main Unit	OFF/5min/10min/30min
EDM Unit	OFF/At once/0.1min/0.5min/3min/10min
Auto Focus	Cont./Sig+Key/Key only
Cont.	Select "Cont." to continuously autofocus.
Sig+Key	Select "Sig+Key" to autofocus when either a return signal from a prism target is detected, or when [AF] key is pressed.
Key only	Select "Key only" to autofocus when the [AF] key is pressed.
Sleep	OFF/1min/3min/5min

Auto Focus

Cont. (Continuous) Auto Focus can be set only when the EDM Unit Power Saving setting is OFF.

If the Auto Focus setting is changed to Cont. when the EDM Unit power saving setting is enabled (At once/0.1 min/0.5 min/3 min/10 min) the confirmation screen will be displayed.

Select **[Yes]** to change the EDM Unit power saving setting to OFF, this will also set Auto Focus to continuous mode.

Select **[No]** to cancel the change of Auto Focus setting to Cont. The EDM Unit power saving setting will not change.

If the EDM Unit power saving setting is enabled (changed to: At once/0.1 min/0.5 min/3 min/10 min) when the Auto Focus setting is Cont., the alert screen will be displayed and EDM Unit power saving setting will not be changed.

Communications

To open the Communication menu, press **[5]** or select **Comm.** in the *Settings* menu.

Ext.Comm	NIKON/SET
Port	Serial/Bluetooth
Baud	1200/2400/4800/9600/19200/38400 bps
Length	7/8
Parity	EVEN/ODD/NONE
Stop bit	1/2

Stakeout

Press **[6]** or select **Stakeout** in the *Settings* menu to open the *Stakeout* menu.

Add PT Integer between 1 and 999,999

This field sets the default point number to record observed data in stakeout.

Unit

To open the Unit menu, press **[7]** or select **Unit** in the *Settings* menu.

Angle DEG (Degree)
 GON (GON)
 MIL (Mil/6400)
 Distance Meter/US-Ft/I-F

If you select US-Ft or I-Ft, an additional settings screen appears. Use this screen to specify whether to display values in Decimal-Ft or Ft-Inch.



Temp °C (Celsius)
 °F (Fahrenheit)
 Press hPa/mmHg/inHg

The Angle, Distance, Temp, and Press job settings cannot be changed once a job is created.

Recording

To open the Rec menu, press **[8]** or select **Rec** in the *Settings* menu.

Store DB RAW/XYZ/RAW+XYZ
 This setting determines whether raw and/or coordinate data is stored when you record SS, CP, or SO records in the Basic Measurement Screen (BMS) or Stakeout screen.

Data Rec Internal/COM
 Set this field to COM to output data on the COM port when you press **[ENT]** in the BMS or a Stakeout screen. The data is not stored to the job file. For more information, see [Outputting data to the COM port, page 82](#)

Security settings

To open the Security Settings menu, press **[9]** or select Security on the *Settings* menu screen.

Use the Security settings to avoid unauthorized use of the instrument, where a PIN/PUK security code can be activated and the PUK code will be displayed.



- | | |
|------------|--|
| Change PIN | <p>To enable the security PIN Code or change the PIN Code, press [1] or select Change PIN on the Security settings menu.</p> <p>If the security PIN Code is already enabled, the current PIN Code needs to be entered.</p> <p>Enter the current PIN Code then press [ENT] or the OK softkey.</p> <p>If you designate a new PIN Code, enter the new PIN Code, and press [ENT]. To confirm the input, enter the same PIN Code, then press [ENT] or the OK softkey.</p> <p>The PIN Code is a four-digit number, e.g. "1234".</p> <p>The default of PIN Code is "0000". By default, the security setting is not enabled and you will not be prompted to enter the PIN Code when starting the work.</p> |
| Get PUK | <p>To display PUK, press [2] or select Get PUK in the Security settings menu.</p> <p>If you enter an incorrect PIN Code more than ten times, you will be prompted to enter the PUK Code. When the correct PUK Code has been entered, the PIN Code will be reset to "0000". This means that the PIN Code security will be disabled. PIN Code security can be enabled again using the Change Pin instructions above.</p> |

Others settings

To open the Others menu, press **[9]** or select **Other** in the *Settings* menu.

- | | |
|----------|--|
| XYZ disp | <p>Fast/Norm/Slow/+ENT</p> <p>Defines speed to move to the next screen after showing XYZ of the input PT</p> |
| 2nd Unit | <p>None/Meter/US-Ft/I-Ft</p> <p>When the Secondary unit is set to a unit, an extra display screen is available in the BMS, stakeout observation screens, and 2-pt reference line screens. The extra screen shows the HD, VD, and SD in the secondary unit.</p> |
| Split ST | <p>No/Yes</p> <p>Select Yes to separate the point numbers of station points from other record type point numbers</p> |
| CD Input | <p>ABC/123</p> <p>Sets the default input mode when a CD field appears.</p> |

If you select US-Ft or I-Ft, an additional settings screen appears. Use this screen to specify whether to display values in Decimal-Ft or Ft-Inch.

If you set the Split ST field to Yes, an additional setting screen appears. Use this screen to specify the starting ST number.

Language	Select a language from the list. Press \leftarrow / \rightarrow to open the select language screen. Press \uparrow / \downarrow to move the cursor to the desired language, and press ENT to select it. A Reboot confirmation screen appears. Press ENT and re-start the instrument, and the selected language will be available.
Signal Beep	OFF/ON Select ON to make a beep sound once, when getting the reflected signal from a prism target.
Owner's Detail	Up to 20 characters. Enter your name or the name of your company. If you enter a value in this field, it appears at start-up.



Tip – To provide easier configuration for common regional settings, you can quickly configure the Nikon total station to a pre-set combination of default regional settings. For more information, see [Changing Regional Configuration Presets, page 29](#).



Tip – The Nikon total station supports up to 9 languages on the instrument. For more information on changing the language settings, see [page 112](#).

Data

Use the Data menu to view or edit records. To display the Data menu, press 4 on the *MENU* screen.



Viewing records

You can view data at any time, even in an observation screen or while entering points.

Viewing raw data

To show the raw data records in a list, press 1 on the *Data* menu screen.

When you first view the raw data, the last four raw records in the current job are displayed. Use \uparrow or \downarrow to scroll through the records.

To see detailed information for the selected records, press ENT .

To return to the record list, press ESC .

SS, CP, F1 records

Raw SS, CP and F1 records contain PT, HT, CD, HA, VA, and SD fields.

SS records are sideshots (topo shots). All shots from the Basic Measurement Screen (BMS) are stored as SS records.

CP records are shots taken in the *Angle* or *Repeat* menus, or in the BMS. For more information, see [Recording a foresight point after repeat angle measurement, page 54](#), and [Recording data from any observation screen, page 81](#).

When the Store DB setting is set to RAW+XYZ, press **[DSP]** to switch between the first screen (showing HA, VA, SD, PT, and HT) and the second screen (showing X, Y, Z, PT, and CD).

Coordinates are not available in F1 records.

When you take more than one measurement to the same point and choose to overwrite the XYZ data, the old raw record becomes raw data only. As a result, only one SS(RAW) record keeps its corresponding SS(XYZ) record. Other SS(RAW) records to the same point no longer have coordinates available.

ST records

ST (station) records contain ST, HI, BS, and AZ fields.

Press **[DSP]** to switch between the first screen (showing ST, HI, BS, and AZ) and the second screen (showing X, Y, Z, PT, and CD).

When you assign a new ST point name in MENU > Stn Setup > Quick, the coordinates of the station is recorded as (0, 0, 0).

SO records

SO records are stakeout shots. These are shots recorded in stakeout functions.

When the Store DB setting is set to RAW+XYZ, press **[DSP]** to switch between the first screen (showing HA, VA, SD, PT, and HT), the second screen (showing X, Y, Z, PT, and CD), and the third screen (showing dX, dY, dZ, PT, and CD).

The dX, dY, and dZ fields store the difference between the stakeout shot's actual position and its planned position. These fields are downloaded as comment records in Nikon RAW format.

CO records

A CO record is a comment added to the job from the system.

For example, when you change the Stn-Z using the Remote Benchmark function, or you reset the horizontal angle using the BSCheck function, the system writes a comment record.

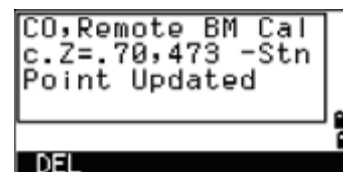

When you input a Stn-XYZ by Base-XYZ function, the recorded station appears as a comment record.

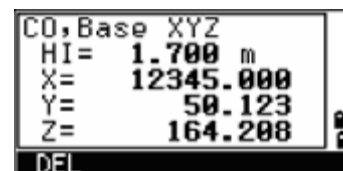

SY records

When you complete a station setup, a SY record is stored. This record contains the Temperature, Pressure, and Prism Constant values.

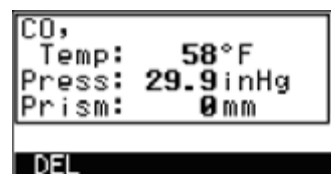
**RM records**

When you record measurements in RDM (Cont) or RDM (Rad), they are labeled as RM records.

Each RM record consists of two screens.

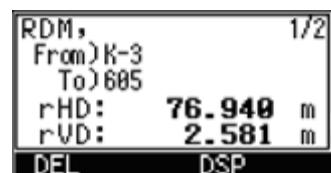

Press **[DSP]** to switch between the first screen (showing From, To, rHD, and rVD) and the second screen (showing rAZ, rSD, rV%, and rGD).

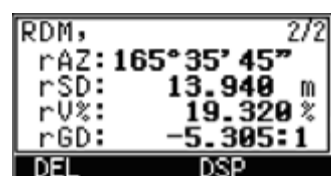

When you download data in Nikon RAW format, RM records are output as comment (CO) records.

AR records

An AR record stores an area and perimeter calculation.

When you download data in Nikon RAW format, AR records are output as comment (CO) records.

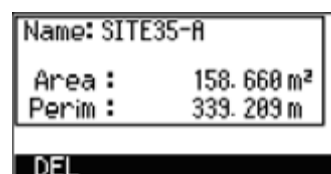
**View coordinate data**

When you press **[2]** or select **XYZ data** in the Data menu, coordinate data appears in a list, with the newest record at the bottom of the screen. Use **[^]** or **[v]** to scroll through the records. Use **[<]** or **[>]** to move up or down one page.



Press **[ENT]** to see more detailed information about the selected record.

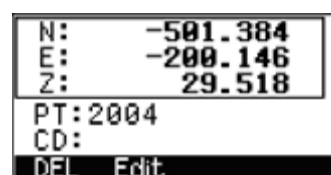

The header (XYZ, YXZ, NEZ, or ENZ) depends on the Coord. Label setting in MENU > Settings > Coord. For more information, see [Coordinate, page 108](#).

UP, MP, CC, and RE records

All coordinate records contain PT, CD, X, Y, and Z fields.

UP records are uploaded point coordinates. MP records are manually input point coordinates. CC records are points calculated in Cogo, and RE records are points calculated in Resection.

When the Store data setting is set to RAW+XYZ or to XYZ, shots in the BMS (SS records), in various O/S functions (SS records), in 2Pt-RefLine and Arc-RefLine in PRG (SS records) and in some Stakeout functions (SO records) store coordinate records as well. The format of the data is the same as other coordinate records.

View records by station

To view records by station, press **[3]** or select **ST->SS/SO/CP** in the Data menu.

A list of all stations appears.

Use **[^]** or **[v]** to highlight the station name that you want to view. Use **[<]** or **[>]** to move up or down one page.

To view detailed information about the selected station, press **[ENT]**.

To display all the observation data from the selected station in chronological order, press **[ENT]** again.

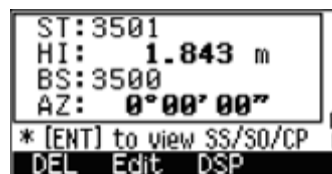

Detailed data is as for raw data. For detailed information about each point type and format, see [Viewing raw data, page 112](#).

Deleting records

Deleting raw records

In the *RAW* screen, use **[^]** or **[v]** to highlight the record that you want to delete. Then press the **DEL** softkey.

A confirmation screen appears. To delete the selected record, press **[ENT]** or the **Yes** softkey.

If the *Store DB* setting is set to Both, the system also deletes the corresponding coordinate data when you delete an SS, SO, or CP record.

You can also delete raw data by pressing the **DEL** softkey in the detailed display screen for the record.

Deleting coordinate records

In the *XYZ* screen, use **[^]** or **[v]** to highlight the record that you want to delete. Then press the **DEL** softkey.

A confirmation screen appears.

To delete the selected record, press **[ENT]** or the **Yes** softkey.

To cancel the deletion of data, press **[ESC]** or the **No** softkey.

You can also delete coordinate data by pressing the **DEL** softkey in the detailed display screen for the record.

If the record that you want to delete is referred by an ST record, a confirmation message appears.

Deleting station records

In the *Station* screen, use \uparrow or \downarrow to highlight the record that you want to delete. Then press the **DEL** softkey.

A confirmation screen appears.

Press **ENT** or the **YES** softkey to delete the selected record.

A reconfirmation screen appears. Press the **DEL** softkey to confirm deletion.

There is no undelete function on the instrument. Before you press the **DEL** softkey, make sure that you have selected the correct station record. You cannot press **ENT** in this screen.

All observations from the station that you selected are deleted.

When you delete a ST record in the raw data view or the station data view, all the observation data from the station is also deleted.

Editing records

For any point record, you can edit the point name (PT), feature code (CD), height of target (HT), height of instrument (HI), backsight point (BS), and backsight azimuth (AZ).

You cannot edit the CD field for SO or F1 records.

You cannot edit the HA, VA, or SD values.

Editing raw records

1. Do one of the following:
 - In the *RAW* screen, highlight the record that you want to edit. Then press the **Edit** softkey.
 - In the detailed data screen, press the **Edit** softkey.
2. Use \uparrow or \downarrow to highlight a field. Then modify the value in the selected field.

When you change the HT of an SS, SO, or CP measurement record, its Z coordinate is recalculated.

3. When you press **ENT** on the last line of the edit screen, a confirmation screen appears.
4. Do one of the following:
 - To accept the changes and return to the data view screen, press **ENT** or the **YES** softkey.
 - To return to the edit screen, press **ESC** or the **NO** softkey.

Editing coordinate records

You can edit PT, CD, and coordinate values in coordinate records.

You cannot edit the coordinate record for the current station.

1. Do one of the following:
 - In the *XYZ* screen, use \uparrow or \downarrow to highlight the record that you want to edit. Then press the **Edit** softkey.
 - In the detailed data screen, press the **Edit** softkey.
2. Use \uparrow or \downarrow to highlight a field. Then modify the value in the selected field.
3. To finish editing, press **ENT** in the *CD* field. A confirmation screen appears.
4. Do one of the following:
 - To accept the changes and return to the data view screen, press **ENT** or the **YES** softkey.
 - To go back to the edit screen, press **ESC** or the **NO** softkey.

Editing station records

Note – The system will not recalculate measurements if you change the station record. All coordinate and raw data observed from an edited station record must be recalculated in your postprocessing software.

In the *RAW* screen, use \uparrow or \downarrow to highlight the station record that you want to edit. Then press the **Edit** softkey.

You can edit any field in the *ST* record, but the instrument does not recalculate any measurements from this station.

Press **ENT** in the *AZ* field to confirm the change.

If you change the *ST* or *HI* values, the coordinates of observation points are not recalculated. A comment record is stored to record the change. The following example shows a comment record for a changed *HI* value:

CO,HI changed at ST:9012 Old HI= 1.345m

If you change the *BS* or *AZ* values, raw records are not recalculated. A comment record is stored to record the change.

Searching records

You can search for records by their type, point name, code, or by any combination of these values.

Searching raw records

In the *RAW* screen, press the **SEARCH** softkey to access the raw data search function.

To find a point by name, enter the name in the *PT* field and press **ENT** twice.

You can use the asterisk (*) as a wildcard. For example, when you enter 300* in the *PT* field, the search matches the points named 300, 301, 302, 3000A2, and 3010.



To search by point type, move to the Type field and use **←** or **→** to change the selected point type. The options are ALL, ST, SS, SO, CP, CO, CO(SY), and CO(RDM).

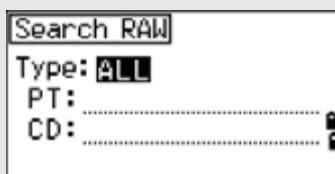

If you selected ST, SO or F1 in the Type field, you do not have to enter a value in the CD field. Press **ENT** in the *PT* field to start the search.

If you selected CO, CO(SY), or CO(RDM) in the Type field, you cannot enter a value in the *PT* or *CD* fields. Press **ENT** in the Type field to start the search.

If more than one point matches the search criteria, the matching points are displayed in a list.

Use **↑** or **↓** to highlight the point you want to use. Then press **ENT** to select it.

Detailed data for the selected record appears. Press the **DISP** softkey to change the fields shown.

Press **ESC** to return to the list.

If no point matches the specified criteria, an error screen appears. Press any key to return to the data screen.

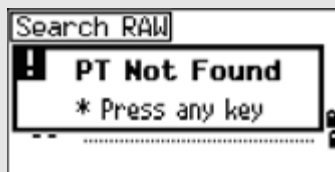

Searching coordinate records

In the *XYZ* screen, press the **SEARCH** softkey to access the *XYZ* data search function.

To find a coordinate by name, enter the name in the *PT* field and press **ENT** twice.

You can use the asterisk (*) as a wildcard. For example, when you enter 500* in the *PT* field, the search matches the points named 500, 500-1, 500-A, and 5000.



To search by point type, move to the *Type* field and use **←** or **→** to change the selected point type. The options are ALL, MP, UP, CC, and RE.

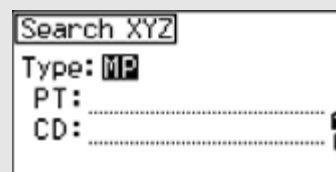

If more than one point matches the search criteria, the matching points are displayed in a list.

Use **↑** or **↓** to highlight the point you want to use. Press **ENT** to select it.

Detailed data for the selected record appears. Press the **DETAILS** softkey to change the fields shown.

Press **ESC** to return to the list.

If no point matches the specified criteria, an error screen appears. Press any key to return to the data screen.

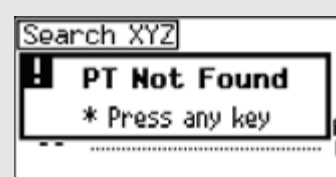

Entering coordinates

In the *XYZ* screen, press the **INPUT** softkey to display a new input point screen.

The *PT* field defaults to the last recorded *PT* + 1, but you can change the value shown.

Enter the *PT* and *CD* and then press **ENT** to enter coordinates.

Use the numeric keys to enter the coordinates. Press **ENT** or **↓** in each field to move to the next field.

When you press **ENT** in the *CD* field, the point is stored as an MP record.

After you have recording a point, the next point input screen is shown with the updated default *PT*.

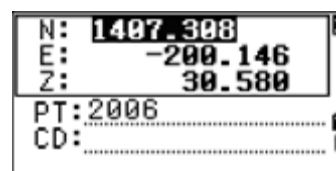

You can record NE, NEZ, or Z-only data to the database.

Point name list and code list

The instrument stores two list files: a list of PT names and a list of CD names. The structure and functionality of these files is the same.

- The *PT name list* is useful if you have to handle more than one patterns of point names in the field. For example, you may need to use points named 1, 2, 3 ..., as well as points named A1, A2, A3
- The *Code list* is a prepared list of feature codes. You can use it to store your own codes.

Press **[4]** or select `PT name List` in the `Data` menu to open the point name list.

Press **[5]** or select `Code list` to open the code list.

The point or code names and layers are shown in alphabetic order. Use the four softkeys to customize the list.



You can store up to 254 points, codes, or layers in each list.

Each list entry can be up to 16 characters long.

You can use the first character search to find a point, code, or layer in the list. In the list screen, enter the first character of the name you want to find to jump to that part of the list. For more information, see [Advanced feature: Searching for a code by using the first character, page 46](#).

Deleting points, codes, or layers

In the point or code list, use **[^]** or **[v]** to highlight the item you want to delete. Then press the `DEL` softkey.

A confirmation screen appears. Press **[ENT]** or the `Yes` softkey to delete the item.

Press **[ESC]** or the `No` softkey to cancel the deletion.

To delete a whole layer, highlight the layer name in the list and press the `DEL` softkey. All codes and layers in the selected layer are deleted.

Editing an item in the point list or code list

Use \uparrow or \downarrow to highlight the item that you want to edit. Then press the **Edit** softkey.

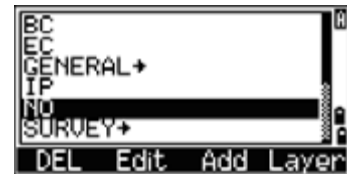

An editing screen appears. For points, the Edit Item screen appears. It contains only the PT field. For codes, the Edit Code screen appears, containing the CD field and the REC field.

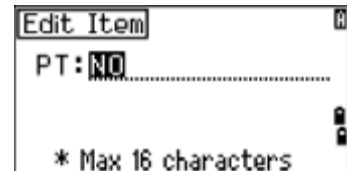

Edit the text shown and then press **ENT**.

A confirmation screen appears. Press **ENT** or the Ψ softkey to accept the changes and update the list.

Edit code list

- The *Edit Code* screen has two fields. The *CD* field contains the text that appears in the list screen. The *REC* field is optional. It contains the text that is stored in the job. If you leave the *REC* field blank, the value in the *CD* field is used.
- You can use the *REC* field to use familiar words or codes on the screen, but store a numeric code in the job. For example, if you set the *CD* field to MANHOLE and the *REC* field to 1155, the text MANHOLE appears on the screen, but the code 1155 is stored.

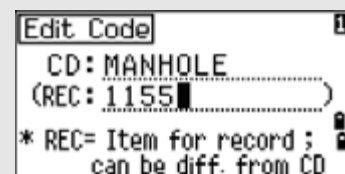
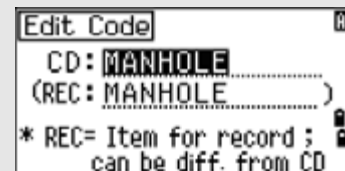

If you press the **Edit** softkey when a layer name appears, only the Lyr field appears. To save changes to the layer name, press **ENT** in the Lyr field.

Adding a point name

In the point list, press the **Add** softkey to add a new point name to the current layer.

Enter a new point name and then press **ENT**.

The point name is added to the current layer and the list is updated.

Adding a code

In the code list, press the **Add** softkey to add a new feature code to the current layer.



Enter the feature code in the CD field. Press **MODE** to change between alphabetic and numeric input mode.

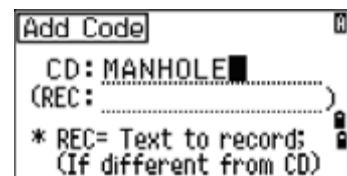

You can use the REC field to define a numeric identifier for each feature code. This is optional: If there is a value in the REC field, this value is stored. If you leave the REC field blank, the CD value is stored.

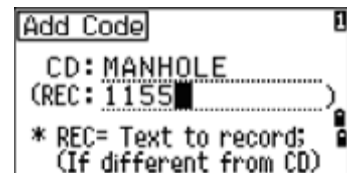

Press **ENT** to add the new code and update the code list.



Adding a layer

1. In the point or code list, press the **Layer** softkey.
2. Enter the name of the new layer.
3. To change between alphabetic and numeric input mode, press **MODE**. To store the new layer, press **ENT**.

The new layer is added to the list in alphabetic order.

Communication

Use the Communication menu to download or upload data. To display the Communication menu, press **[5]** or select **Comm.** on the *MENU* screen.



Downloading data

To go to the download settings screen, press **[1]** or select **Download** in the *Communication* menu.

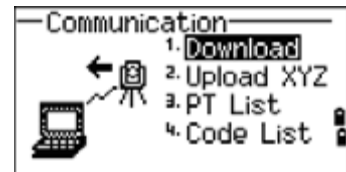

Format NIKON
 SDR2x
 SDR33

Data RAW
 Coordinate

To display the total number of records that will be downloaded, press **[ENT]** in the *Data* field.

As each record in the current job is output from the instrument (downloaded), the current line number is updated.

After downloading is completed, you can choose to delete the current job.

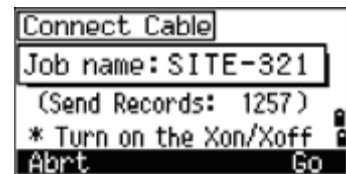

To delete the current job, press **[4]**. To return to the Basic Measurement Screen (BMS), press **[ESC]** or the **Abrt** softkey.

Uploading coordinate data

To upload coordinate data from a computer, press **[2]** or select **Upload XYZ** in the *Communication* menu.

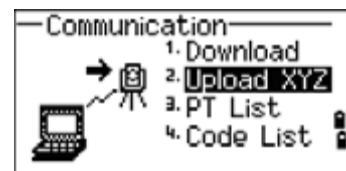

The default data format appears. To change the order of data fields, press the **Edit** softkey. For more information, see [Advanced feature: Editing the data order for upload, page 124](#).



Otherwise, just press **[ENT]**.

Press the **Job** softkey to go to the *Job Manager* screen. For more information, see [Job Manager, page 92](#).

To change the communication settings, press the **Comm** softkey. The *Communication* screen appears. In the *Port* field, select Serial or Bluetooth/BT Device/USB. The port settings must match the settings used by the terminal software on the computer.

Use an RS-232C cable to connect the instrument to the computer. Establish communication when port setting is Bluetooth. Input 0530 if PIN is required.

The *Free space* field shows the number of points that can be stored.

Press **[ENT]** to put the instrument in receive mode. Then use the *Send Text File* command in the terminal program on the computer to start sending data.

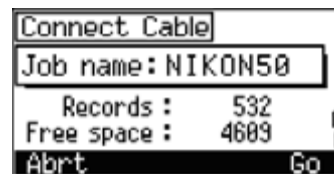

In the terminal program, set flow control to Xon/Xoff.

As each point is received by the instrument, the value in the *Records* field is incremented.

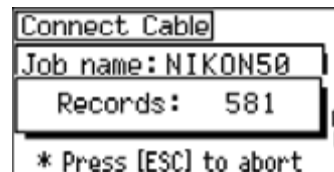

If you press **[ESC]** during data upload, the upload is cancelled and the display returns to the Communication menu. Records that were received before you pressed **[ESC]** are stored in the job.

The system truncates any code that is longer than 16 characters.

Duplicate points:

If the existing point is a UP, CC, or MP record, and it is not referred to by any ST or BS, it is automatically overwritten by the uploaded point. No error message appears.

Advanced feature: Editing the data order for upload

1. To open the *Data Fields* screen, press the **Edit** softkey.
2. To move between the fields, press **[<]** or **[>]**.
3. To change the selected item in a field, use the **[+]** and **[-]** softkeys. The options are PT, N, E, Z, CD, or blank.
4. To save your changes and return to the previous screen, press the **Save** softkey.

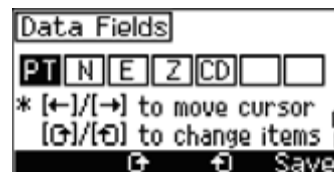

For example, if your original data is as follows:

1, UB, 30.000, 20.000, L1

and you set the data fields to PT N E CD, then the uploaded data is:

PT=1, N=30.000, E=20.000, CD=L1

Uploading coordinates without points

You can upload data without points. If you do not include a point in the format definition, each line of data is automatically assigned the next available point number. To help you to select points in the field, make sure that you store an identifier in the CD field.

The data format cannot include duplicate items. Use PT, N, E, Z and CD once each in the data format. To skip some items in your original file, set the corresponding field to blank.

Uploading a point name list or code list

When you upload a code list, it always replaces the existing code list on the instrument.

To upload a point name list via cable, press **[3]** or select **PT List** in the *Communication* menu.

To upload a code list, press **[4]** or select **Code List**.

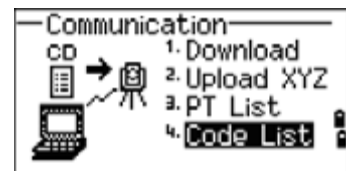

Connect the RS-232C cable.

Start a terminal program on the computer.

To put the instrument into receive mode, press **[ENT]** or the **OK** softkey.

The counter is updated as each line in the list is stored.

You can store up to 254 codes or point names.

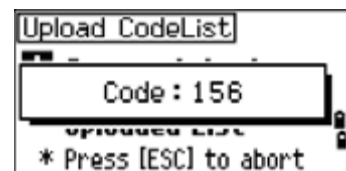

If a code or point name is longer than 16 characters, it is truncated.

1sec-Keys

Use the 1sec-Keys menu to configure the settings for the one-second keys, [MSR], [DSP], [USR], [S-O], and [DAT]. To access this menu, press [6] or select 1sec-Keys in the *MENU* screen.



[MSR] key settings

To change settings for the [MSR1] and [MSR2] keys, press [1] or select [MSR] in the *1sec-Keys* menu.

There are two [MSR] keys:

- To change the settings for the [MSR1] key, press [1] or select MSR1.
- To change the settings for the [MSR2] key, press [2] or select MSR2.

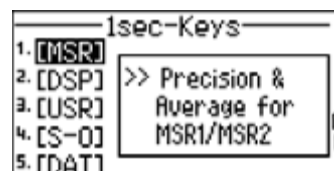

Each [MSR] key has five settings.

In the *Const* and *AVE* fields, use the numeric keys to enter values. In the other fields, use [←] or [→] to change the settings.

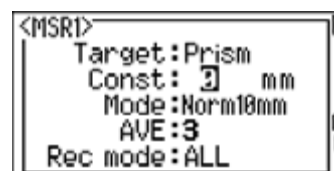

Tip – You can also access the settings screen by holding down [MSR1] or [MSR2] for one second.

[DSP] key settings

To change the display items in the BMS and in Stakeout observation screens, press [2] or select [DSP] in the *1sec-Keys* menu.

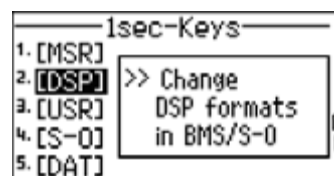

To move the cursor, use [←], [→], [↑], or [↓]. To change the display item, press either the [G] softkey or the [H] softkey.

To save the changes, press [ENT] at the last line of <DSP3> or press the [Save] softkey.

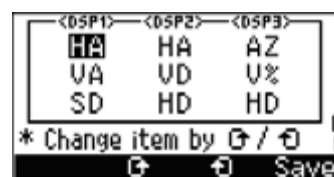

Tip – You can also access the DSP settings screen by holding down [DSP] for one second.

[USR] key settings

To change the functions that are assigned to the **[USR1]** and **[USR2]** keys, press **[3]** or select **[USR]** in the *Isec-Keys* menu.

There are two **[USR]** keys. The function that is assigned to each key appears beside the key name.

- To change the settings for the **[USR1]** key, press **[1]** or select **USR1**.
- To change the settings for the **[USR2]** key, press **[2]** or select **USR2**.

In the *Select Functions* screen, the asterisk (*) indicates the function that is currently assigned to the key.

To highlight a function, use **[^]** or **[v]**. To assign that function to the selected **[USR]** key, press **[ENT]**.

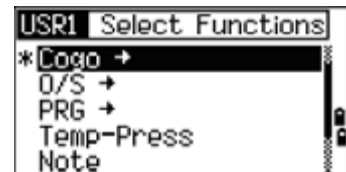

[S-O] key settings

To enter the Stakeout settings screen, press **[4]** or select **[S-O]** in the *Isec-Keys* menu.

There are two Stakeout settings. For more information, see [Stakeout, page 110](#).

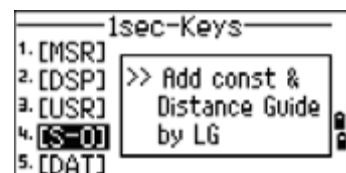

[DAT] key settings

1. To change the settings for the **[DAT]** key, press **[5]** or select **[DAT]** in the *Isec-Keys* menu.

The asterisk (*) indicates the currently selected view format.

2. To move the cursor, use **[^]** or **[v]**.
3. To change the format displayed by **[DAT]**, press **[ENT]**.

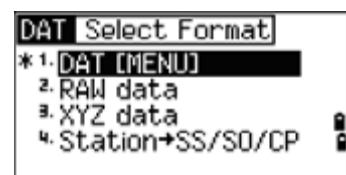

Calibration

Use the Calibration screen to calibrate the instrument.
To open the Calibration screen, press **[7]** or select **Calibrate** on the *MENU* screen.

For more information, see [Adjusting, page 135](#).



Time

Use the Date screen to set the current date and time.

1. To open the Date screen, press **[8]** or select **Time** on the *MENU* screen.



The current date and time settings are displayed.

2. Enter the date in Year-Month-Day format. For example, to change the date to June 18, 2008, press **[2][0][0][8][ENT][6][ENT][1][8][ENT]**.

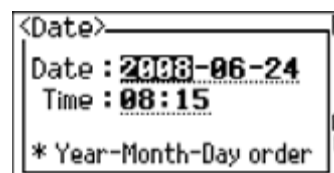

If the highlighted part of the field (for example, the year) is already correct, you can just press **[ENT]** to use the current value. For example, if the date is already set to June 24, 2008, and you want to change the date to June 18, 2008, press **[ENT][ENT][1][8][ENT]**.

3. To move to the *Time* field, press **[ENT]** in the *Date* field.
Enter the time in 24-hour format. For example, to set the time to 4:35 PM, press **[1][6][ENT][3][5][ENT]**.
4. Do one of the following:
 - To finish setting the date and time, press **[ENT]** in the *Minutes* field.
 - To cancel the input, press **[ESC]**.

Removable Memory (USB Memory)

The removable memory (external memory) shows the list of all the job files that were recorded on the USB memory stick.



The job files and other files that are shown in the list are recorded in the following folders on the removable memory device (USB memory):

- Job files are stored in \NTTS\JOBS
- Other files are stored in \NTTS

Do not remove the USB memory stick while you are accessing it. Doing so may damage the files in the USB memory.

For more efficient operation it is best to use a low capacity USB stick with not many files on it.

When this message is displayed for a long time, please reduce the number of files on the removable memory as much as possible, and then retry it. A USB memory may not function in this product depending on the type. In this case, use a different type of USB memory.



Displaying the external memory files

1. Press \square or select **USB Mem.** on the MENU screen. The *USB Memory (Job)* screen appears. This screen shows all the job files that are currently on the removable device.
2. To view other files, select the **File** softkey to change the list.
To return to the USB Memory (Job) screen, select the **Job** softkey.

Note – When you have imported the file from the USB Memory to the instrument, you can open the job on the instrument.

Renaming a job or file on the removable memory

Do one of the following:

- Rename a job file from the *USB Memory (Job)* screen.
 - Rename a file from the *USB Memory (file)* screen.
1. Press \downarrow or \uparrow to highlight the job or file that you want to rename.
 2. Press the RENAME softkey. The *Change Name* screen appears showing the current name of the job or file.
 3. Enter a new name and then press ENT .

A **job name** may not be longer than 8 characters. A **file name** may not be longer than 12 characters—this includes the file extension.

You can not use a period in a job or file name.

Deleting a job or file from the removable memory



CAUTION – There is no undelete function in the External Memory. Before you select DEL , make sure that the selected job is the one that you want to delete.

1. Press \downarrow or \uparrow to highlight the job or file that you want to rename.
2. Press the DEL softkey. A confirmation screen appears.
3. Do one of the following:
 - To delete the selected job, press the DEL softkey.
 - To cancel the deletion and return to the previous screen, press ESC or the ABRT softkey.

After you delete a job, the display returns to the job list.

In the *Delete* screen you cannot press Ent . You must verify the file name and then press the DEL softkey.

Copying a job from the removable device

You can copy a job that is on the removable device to the instrument.

1. Press \downarrow or \uparrow to highlight the job or file that you want to copy.
2. Press MENU and then press I *Import Job*.

Changing the list view of files on the removable memory

USB Memory (Job) screen

Press the **DSP** softkey to view the list in alphabetical order or in date order.

USB Memory (File) screen

Press the **DSP** softkey to view the list in alphabetical order, in date order, or by file extension.

Checking and Adjustment

In this chapter:

- [Adjusting the Electronic Level](#)
- [Checking and Adjusting the Circular Level](#)
- [Checking and Adjusting the Optical/Laser Plummet](#)
- [Zero Point Errors of Vertical Scale and Horizontal Angle Corrections](#)
- [Auto Focus](#)
- [Checking the Instrument Constant](#)
- [Checking the Laser Pointer](#)

Adjusting the Electronic Level

Adjustment of the electronic level is done by Zero point errors of vertical scale and horizontal angle corrections. For detailed instruction, please see [page 135](#).

Checking and Adjusting the Circular Level

Once you have checked and adjusted the electronic level, check the circular level.

If the bubble is not in the center of the level, use the adjusting pin to rotate the three adjustment screws of circular level on the tribrach until the circular level of the instrument is centered.



Checking and Adjusting the Optical/Laser Plummet

The optical axis of the plummet must be aligned with the vertical axis of the instrument.

To check and adjust the optical/laser plummet:

1. Place the instrument on the tripod. You do not have to level the instrument.
2. Place a thick sheet of paper marked with an X on the ground below the instrument.

While you are looking through the optical plummet, adjust the leveling screws until the image of the X is in the center of the reticle mark .

For laser plummet, adjust the laser pointer to the X.

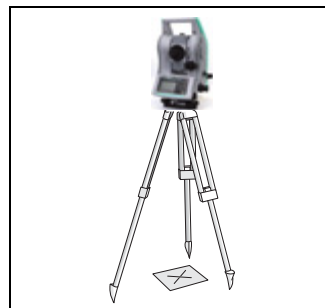

3. Rotate the alidade 180°.

If the marked image is in the same position in the center of the reticle mark, no adjustment is required

For laser plummet, if the laser pointer is on the X, no adjustment is required.

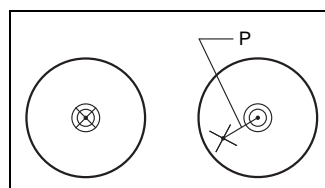

4. If the image or laser pointer is not in the same position, adjust the optical or laser plummet:

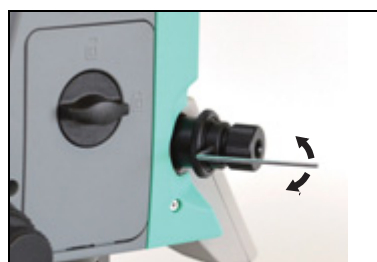

- a. Use the supplied hexagonal wrench to turn the adjustment screws until the image of the X is in Position P. Position P is the center point of the line connecting the X and the center of the reticle mark .
- b. Repeat from [Step 2](#).
For laser plummet adjustment, a cap needs to be removed.

Zero Point Errors of Vertical Scale and Horizontal Angle Corrections

Checking

1. Set up the instrument on the tripod.
2. Follow the leveling procedures described in [Leveling, page 17](#).
3. Flip the telescope to the Face-1 position.
4. Sight a target that is within 45° of the horizontal plane.
5. Read the vertical angle from the VA1 field in the Basic Measurement Screen (BMS).
6. Rotate the instrument 180° and flip the telescope to the Face-2 position.
7. Read the vertical angle from the VA2 field.
8. Add the two vertical angles together, VA1 + VA2.
 - No adjustment is required if the zero reference for vertical angles (VA zero setting) is set to Zenith, and VA1 + VA2 equals 360° .
 - No adjustment is required if the zero reference for vertical angles (VA zero setting) is set to Horizon, and VA1 + VA2 is either 180° or 540° .
 - An adjustment is required if VA1 + VA2 is not one of the values listed above.

Note – The difference between the vertical angle reading the relevant angle (either 360° for Zenith, or 180° or 540° for Horizon) is called the **altitude constant**.

Adjusting

1. To enter the calibration screen, press **[MENU]** and **[7]** Calibrat.

The *Calibration* screen appears.

2. To calibrate Zero Point Errors of Vertical Scale and Horizontal Angle, press **[1]** or select VA0/HA/Tilt in the calibration menu.

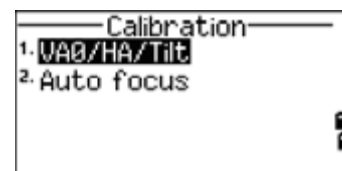

3. The Nikon XS Series has two-axis level compensation. Take an F1 measurement to a target on the horizon. Press **[ENT]**.

The vertical angle is shown in the V0 dir= Horiz setting.

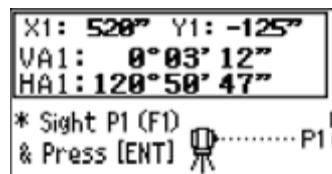

- VA1 Face-1 vertical angle (tilt-off value)
 HA1 Face-1 horizontal angle (tilt-off value)
 X1 Face-1 X axis tilt value
 Y1 Face-1 Y axis tilt value

When you have taken the measurement, the message on the bottom line changes from DO NOT TOUCH! to Turn to F2.

4. Take an F2 measurement to the same target. Press **[ENT]**.

- VA2 Face-2 vertical angle (tilt-off value)
 HA2 Face-2 horizontal angle (tilt-off value)
 X2 Face-2 X axis tilt value
 Y2 Face-2 Y axis tilt value

When the observation on F2 is completed, four parameters are displayed.

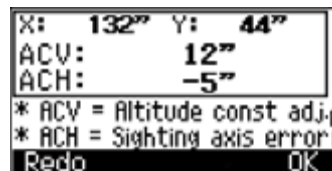

5. Do one of the following:
- To return to the first observation screen, press **[ESC]** or the **Redo** softkey.
 - To set parameters on the instrument, press **[ENT]** or the **OK** softkey.

If ACV, ACH, X, or Y is out of range, OVER appears. Press any key to return to the first observation screen.

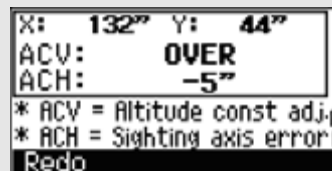

Auto Focus

Adjusting

1. To calibrate Auto Focus, press [2] key or select Auto Focus in the Calibration menu.

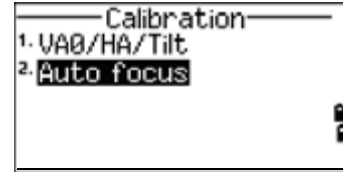

2. Sight a non-prism point that is between 2 m and 4 m away and focus manually using the focus ring.

Then press + or – softkey to fine adjust the focus, once fine adjustment is complete, press the MSR softkey.

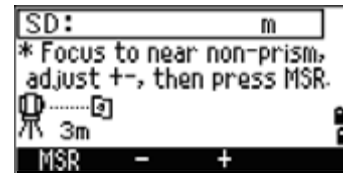

Note – The MSR softkey appears after pressing + or – softkey, and disappears after moving the focus ring. When the MSR key is pressed, a distance measurement is started using reflectorless precise mode.

3. After measuring the near point, sight a non-prism point at least 100 m away, and follow the same focusing procedure as above: first using the focus ring, then + or – softkey for fine adjustment.

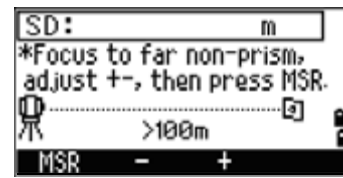

Then measure the distance by pressing MSR softkey.

4. Once both the near and far measurements are complete, the calibration constant will be calculated. If the calibration is successful, the following screen will be displayed.

Press Save softkey for saving the constant and return to the calibration menu.



Checking the Instrument Constant

The instrument constant is a numerical value used to automatically correct for the displacement between the mechanical and electrical centers when measuring distances. The instrument constant is set by the manufacturer before the instrument is shipped. However, to ensure the highest operational accuracy, we recommend that you check the instrument constant several times a year.

To check the instrument constant, you can either compare a correctly measured base line with the distance measured by the EDM, or follow the procedure below.

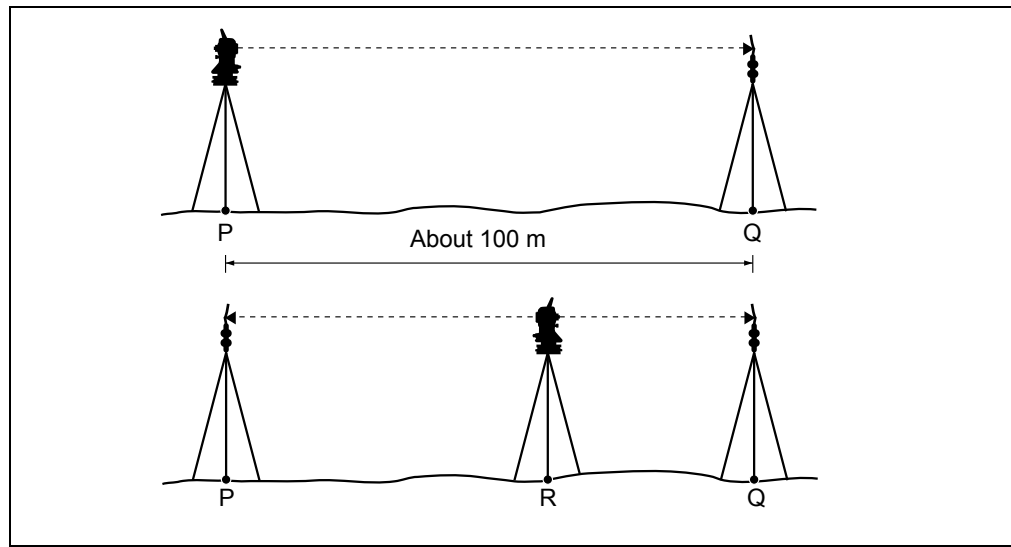

To check the instrument constant:

1. Set up the instrument at Point P, in as flat an area as possible.
2. Set up a reflector prism at Point Q, 100 m away from Point P. Make sure that you take the prism constant into account.
3. Measure the distance between Point P and Point Q (PQ).
4. Install a reflector prism on the tripod at Point P.
5. Set up another tripod at Point R, on the line between Point P and Point Q.
6. Transfer the instrument to the tripod at Point R.
7. Measure the distance from Point R to Point P (RP), and from Point R to Point Q (RQ).
8. Calculate the difference between the value of PQ and the value of $RP + RQ$.
9. Move the instrument to other points on the line between Point P and Point Q.
10. Repeat [Step 5](#) through [Step 9](#) ten times or so.
11. Calculate the average of all the differences.

The error range is within 3 mm. If the error is out of range, contact your dealer.

Checking the Laser Pointer

The Nikon XS Series total station laser pointer is a red laser beam. The laser pointer is coaxial with the line of sight of the telescope. If the instrument is well adjusted, the red laser pointer coincides with the line of sight. External influences such as shock or large temperature fluctuations can displace the red laser pointer relative to the line of sight.

System Diagrams

In this chapter:

- [System Components](#)

System Components

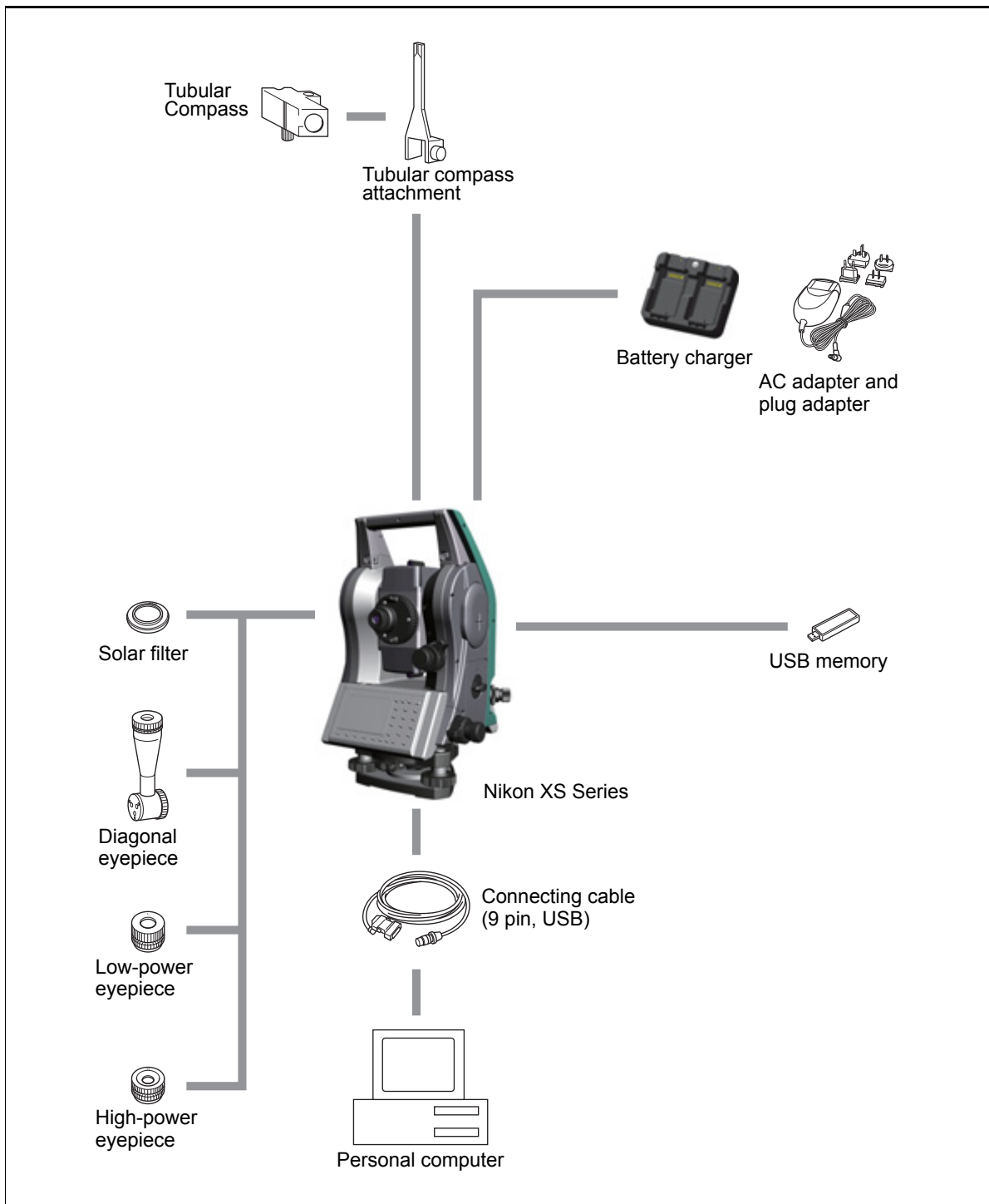

Figure 7.1 Measurement side

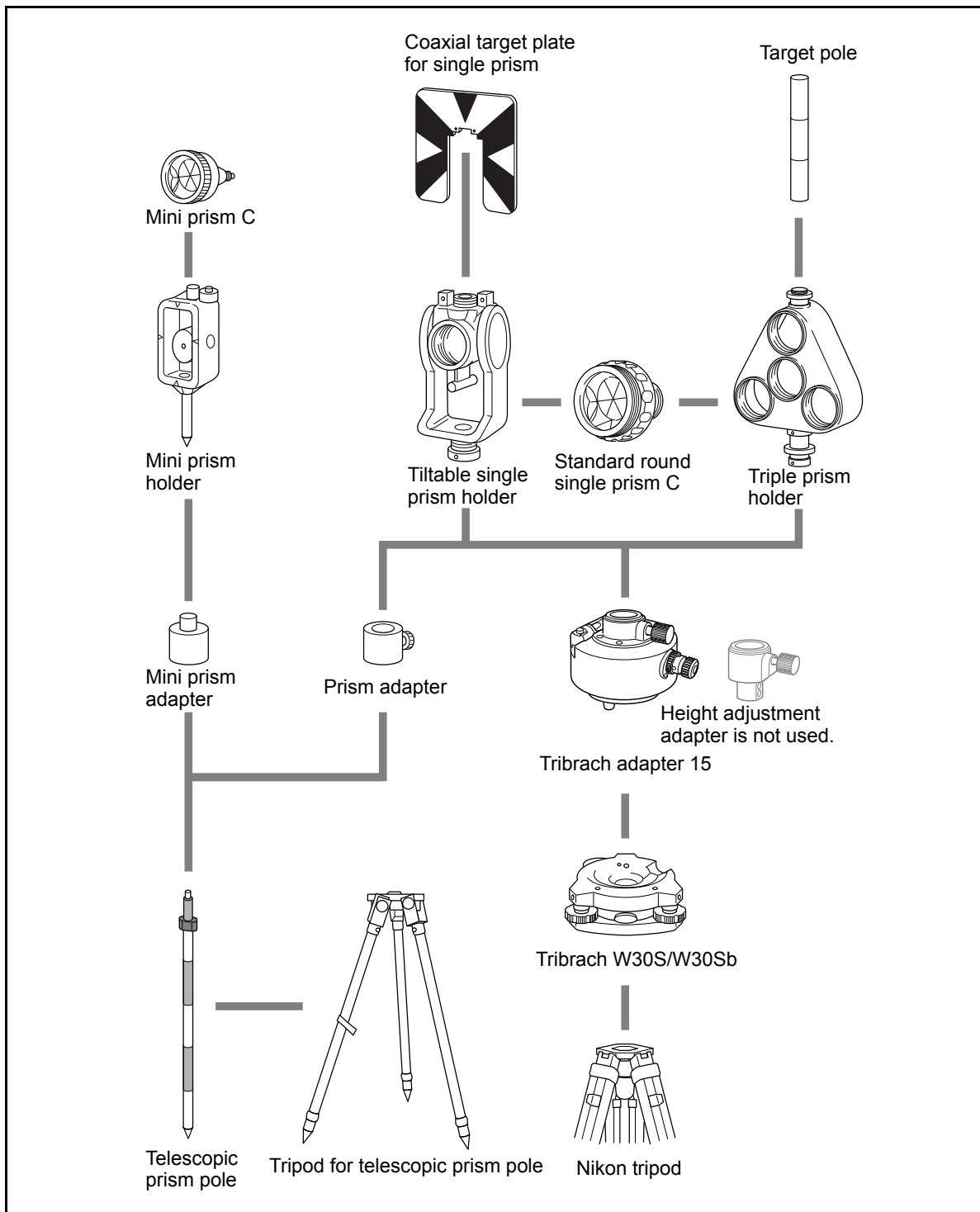

Figure 7.2 Prism reflector side

Note – Nivo Series must be used with the Tribach W30S or W30Sb.

Communications

In this chapter:

- [Uploading Coordinate Data](#)
- [Uploading Point Lists and Code Lists](#)
- [Downloading Data](#)

Uploading Coordinate Data

Settings

To configure the transmission speed and other settings, go to MENU > Settings > COMM. For more information, see [Communications, page 109](#).

Record format

You can upload coordinate records in the following formats:

PT	,	X	,	Y	,	Z	,	CD
----	---	---	---	---	---	---	---	----

PT		X		Y		Z		CD
----	--	---	--	---	--	---	--	----

PT	,	X	,	Y	,	Z
----	---	---	---	---	---	---

PT		X		Y		Z
----	--	---	--	---	--	---

PT	,	X	,	Y	,	,	CD
----	---	---	---	---	---	---	----

PT		X		Y		CD
----	--	---	--	---	--	----

PT	,	X	,	Y	,	,
----	---	---	---	---	---	---

PT	,	X	,	Y	,
----	---	---	---	---	---

PT	,	,	,	Z	,	CD
----	---	---	---	---	---	----

PT	,	,	,	Z
----	---	---	---	---

The record formats shown above use the following codes:

Code	Description	Length
PT	Point number	Up to 20 digits
X	Actual X coordinate	Variable length
Y	Actual Y coordinate	Variable length
Z	Actual Z coordinate	Variable length
CD	Feature code	Up to 16 characters

Data example

20100,6606.165,1639.383,30.762,RKBSS
 20104,1165611.6800,116401.4200,00032.8080
 20105 5967.677 1102.343 34.353 MANHOLE
 20106 4567.889 2340.665 33.444 PT1
 20107 5967.677 1102.343 34.353
 20109,4657.778,2335.667,,PT2
 20111,4657.778,2335.667
 20113 4657.778 2335.667
 20115,,,34.353,MANHOLE
 20117,,,33.444

Uploading Point Lists and Code Lists

Settings

To configure the transmission speed and other settings, go to `MENU > Settings > COMM`. For more information, see [Communications, page 109](#).

File format

PT lists and code lists use the same record format. Use the filenames POINT.LST for a PT list, and CODE.LST for a code list.

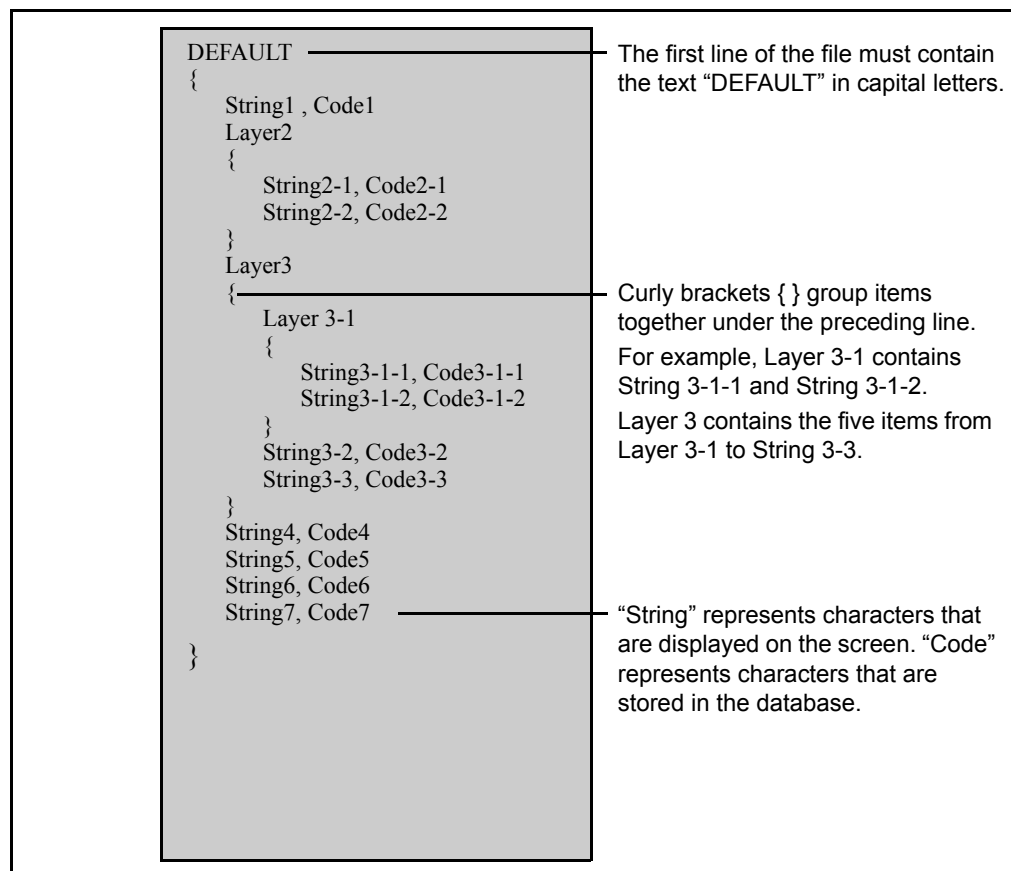

Figure 8.1 Record format for PT lists and code lists

Data example

```
DEFAULT
{
  "STRUCTURES"
  {
    "TREE", "S0001"
    "FENCE", "S0002"
    "MAIL BOX", "S0003"
    "FLOWER BED", "S0004"
  }
  "ROADS"
  {
    "MANHOLE", "R0001"
    "CENTER LINE"
    {
      "WHITE", "R002-W"
      "YELLOW", "R002-Y"
    }
    "SIDEWALK", "R0003"
    "CROSSING", "R0004"
    "BRIDGE", "R0005"
    "SIGNAL", "R0006"
    "HIGHWAY STAR", "R0007"
  }
  "RAILWAY"
  {
    "CROSSING", "RW001"
    "STATION", "RW002"
    "SIGNAL", "RW003"
    "BRIDGE", "RW004"
    "TUNNEL", "RW005"
  }
}
```

Downloading Data

Settings

To configure the transmission speed and other settings, go to `MENU > Settings > Comm`. For more information, see [Communications, page 109](#).

Nikon raw record formats

Coordinate records

type	,	pt	,	(pt id)	,	northing	,	easting	,	elevation	,	code
------	---	----	---	---------	---	----------	---	---------	---	-----------	---	------

type	One of the following codes:
UP	Uploaded point
MP	Manually input point
CC	Calculated coordinate
RE	Resection point
pt	Point number
(pt id)	(Point ID)
northing	Northing of the coordinate
easting	Easting of the coordinate
elevation	Elevation of the coordinate
code	Feature code

Station records

ST	,	stnpt	,	(stnid)	,	bspt	,	(bs id)	,	hi	,	bsazim	,	bsha
-----------	---	-------	---	---------	---	------	---	---------	---	----	---	--------	---	------

ST	Station record identifier (fixed text)
stnpt	Station point number
(stn id)	(Station ID)
bspt	Backsight point number
(bs id)	(Backsight ID)
hi	Height of instrument
bsazim	Backsight azimuth
bsha	Backsight horizontal angle

Control point records

CP	,	pt	,	(pt id)	,	ht	,	sd	,	ha	,	va	,	time	,	code
----	---	----	---	---------	---	----	---	----	---	----	---	----	---	------	---	------

CP	Control point record identifier (fixed text)
pt	Point number
(pt id)	(Point ID)
ht	Height of target
sd	Slope distance
ha	Horizontal angle
va	Vertical angle
time	24-hour time stamp
code	Feature code

Sideshot records

SS	,	pt	,	ht	,	sd	,	ha	,	va	,	time	,	code
----	---	----	---	----	---	----	---	----	---	----	---	------	---	------

SS	Sideshot record identifier (fixed text)
pt	Point number
ht	Height of target
sd	Slope distance
ha	Horizontal angle
va	Vertical angle
time	24-hour time stamp
code	Feature code

Stakeout records

SO	,	pt	,	(sopt)	,	ht	,	sd	,	ha	,	va	,	time	,
----	---	----	---	--------	---	----	---	----	---	----	---	----	---	------	---

SO	Stakeout record identifier (fixed text)
pt	Recorded point number
(sopt)	(Original number of point staked)
ht	Height of target
sd	Slope distance
ha	Horizontal angle
va	Vertical angle
time	24-hour time stamp

F1 records

face	,	pt	,	ht	,	sd	,	ha	,	va	,	time
------	---	----	---	----	---	----	---	----	---	----	---	------

face	One of the following: F1 Shot taken using Face-1 (fixed text) Shot taken using Face-1 for Station setup (fixed text)
pt	Point number
ht	Height of target
sd	Slope distance
ha	Horizontal angle
va	Vertical angle
time	24-hour time stamp

Comment/note records

CO	,	text
-----------	---	------

CO	Comment record identifier (fixed text)
text	Comment text

SDR2x and SDR33 record formats

Header record

00NM	ver	0000	datetime	ang	dist	press	temp	coord	1
-------------	-----	-------------	----------	-----	------	-------	------	-------	----------

1–4	00NM	Header record identifier (fixed text)
5–20	ver	SDR download version. One of the following: SDR20V03-05 SDR2x SDR33V04-01 SDR33
21–24	0000	Not used
25–40	datetime	Download date and time (in hours and minutes)
41	ang	Angle units. One of the following: 1 Degrees 2 Gons 4 Mils
42	dist	Distance units. One of the following: 1 Meters 2 Feet
43	press	Pressure units. One of the following: 1 mm Hg 2 In. Hg 3 hPa
44	temp	Temperature units. One of the following: 1 Celsius 2 Fahrenheit
45	coord	Coordinate order. One of the following: 1 NEZ 2 ENZ
46	1	Not used

Instrument record

01KI1	instr	serNo	Instr	serNo	1	zero VA	0.000	0.000	0.000
--------------	-------	-------	-------	-------	----------	---------	--------------	--------------	--------------

1–5	01KI1	Instrument record identifier (fixed text)
6–21, 28–43	instr	Instrument make and model
22–27, 44–49	serNo	Instrument serial number
50	1	Not used
51	zero VA	The reference point for vertical angles. One of the following: 1 Zenith 2 Horizon
52–61,	0.000	Not used
62–71,	0.000	Not used
72–81,	0.000	Not used

Station details record

02KI	stnpt	northing	easting	elevation	hi	desc
------	-------	----------	---------	-----------	----	------

1–4	02KI					Station details record identifier (fixed text)
5–8 (2x), 5–20 (33)	stnpt					Station point number
9–18 (2x), 21–36 (33)	northing					Northing of station
19–28 (2x), 37–52 (33)	easting					Easting of station
29–38 (2x), 53–68 (33)	elevation					Elevation of station
39–48 (2x), 69–84 (33)	hi					Height of instrument
49–64 (2x), 85–100 (33)	desc					Station description

Target details record

03NM	ht
------	----

1–4	03NM		Target details record identifier (fixed text)
5–14 (2x), 5–20 (33)	ht		Height of target

Backsight bearing details record

07KI	stnpt	bspt	bsazim	ha
------	-------	------	--------	----

1–4	07KI				Backsight bearing details record identifier (fixed text)
5–8 (2x), 5–20 (33)	stnpt				Station point number
9–12 (2x), 21–36 (33)	bspt				Backsight point number
13–22 (2x), 37–52 (33)	bsazim				Backsight azimuth
23–32 (2x), 53–68 (33)	ha				Horizontal angle

Coordinates record

08KI	pt	northing	easting	elevation	desc
------	----	----------	---------	-----------	------

1-4	08KI				Coordinates record identifier (fixed text)
5-8 (2x), 5-20 (33)	pt				Point number
9-18 (2x), 21-36 (33)	northing				Northing of the coordinate
19-28 (2x), 37-52 (33)	easting				Easting of the coordinate
29-38 (2x), 53-68 (33)	elevation				Elevation of the coordinate
39-54 (2x), 69-84 (33)	desc				Feature code

Observation record

09MC	stnpt	pt	sd	va	ha	desc
------	-------	----	----	----	----	------

1-4	09MC					Observation record identifier (fixed text)
5-8 (2x), 5-20 (33)	stnpt					Station point number
9-12 (2x), 21-36 (33)	pt					Observed point number
13-22 (2x), 37-52 (33)	sd					Slope distance
23-32 (2x), 53-68 (33)	va					Vertical angle
33-42 (2x), 69-84 (33)	ha					Horizontal angle
43-58 (2x), 85-100 (33)	desc					Feature code

Job identifier record

10NM	jobid	1	incZ	T&Pcorr	C&Rcorr	refcon	sealev
-------------	-------	----------	------	---------	---------	--------	--------

1–4 **10NM** Job identifier record ID (fixed text)

5–8 (2x), jobid Job name/title
5–20 (33)

Note – The following fields occur only in SDR33 format.

21 **1** Point ID length option

22 incZ 2D or 3D coordinates. One of the following:

1 2D

2 3D

23 T&Pcorr Atmospheric correction. One of the following:

1 Off

2 On

24 C&Rcorr Curvature and refraction correction. One of the following:

1 Off

2 On

25 refcon Refraction constant. One of the following:

1 0.132

2 0.200

26 sealev Sea level correction. One of the following:

1 Off

2 On

Note record

13NM	note
-------------	------

1–4 **13NM** Note record ID (fixed text)

5–64 note Note text

Data examples

Nikon raw data format

CO,Nikon RAW data format V2.00
 CO,EXAMPLE5
 CO,Description: SAMPLE DATA OF DOWNLOAD
 CO,Client:
 CO,Comments:
 CO,Downloaded 22-JUL-2008 18:56:10
 CO,Software: Pre-installed version: 1.0.0.1
 CO,Instrument: Nikon XS 5
 CO,Dist Units: Metres
 CO,Angle Units: DDDMMSS
 CO,Zero azimuth: North
 CO,Zero VA: Zenith
 CO,Coord Order: NEZ
 CO,HA Raw data: Azimuth
 CO,Tilt Correction: VA:ON HA:ON
 CO, EXAMPLE5 <JOB> Created 22-JUL-2008 07:09:21
 CO,S/N:213705
 MP,1,,100.000,200.000,10.000,
 CO,Temp:20C Press:760mmHg Prism:0 22-JUL-2008 07:11:34
 ST,1,,,,1.400,55.4500,55.4500
 F1,,,,0.0000,90.0000,8:27:58
 SS,3,1.200,330.706,326.027,20.320,07:13:46,SIGN
 SS,4,1.250,379.193,300.847,29.084,07:14:24,TREE
 SS,5,1.218,363.344,328.032,30.105,07:14:57,TREE R
 SO,1003,,1.240,331.220,326.783,19.998,07:18:17,

Nikon coordinate data format

1,100.0000,200.0000,10.0000,
 2,200.0000,300.0000,20.0000,
 3,116.9239,216.9140,11.8425,TRAIN PLATFORM
 4,126.6967,206.2596,11.2539,RAMP
 11,100.0045,199.9958,10.0000,
 13,116.9203,216.9113,11.7157,
 14,126.6955,206.2579,10.9908,
 21,100.0103,199.9958,10.0000,
 31,100.0013,200.0005,10.0000,
 41,100.0224,200.0331,9.9000,
 43,116.9263,216.9165,11.8016,CURB
 44,126.7042,206.2871,10.8193,DITCH
 45,116.9266,216.9160,11.8028,
 46,126.7046,206.2845,10.8213,CP POINT

SDR2x raw data format

00NMSDR20V03-05 000023-Jul-2008 18:39:111211
10NMEXAMPLE6
01K11 Nikon XS 5 000000 Nikon XS 5 00000012 0.000 0.000 0.000
13NMDownloaded 23-Jul-2008 18:39:22
13NM SAMPLE <JOB> Downloaded 23-Jul-2007 18:40:06
13NMSoftware: Pre-install version: 3.3.0.1
13NMInstrument: Nikon XS 5
13NMDist Units: Metres
13NMAngle Units: Degrees
13NMZero azimuth: North
13NMZero VA: Horizon
13NMCoord Order: NEZ
13NMClient:
13NMDescription:
13NMTilt Correction: VA:ON HA:ON
13NM EXAMPLE6 <JOB> Created 23-Jul-2008 07:09:21
08KI0001100.000 200.000 10.000
08KI0002200.000 300.000 20.000
02KI0001100.000 200.000 10.000 0.100
07KI0001000245.0000 0.0000
13F100000002<null> <null> 0.0000
13F200000002<null> <null> 179.9639
13NMBS Check HA:359.3525 Reset to HA: 0.0000 07:21:41
13F10000000323.990 4.1694 0.0000
13F20000000323.990 175.8403 180.0028
03NM0.000
13F10001000323.990 4.1653 359.9833 MAIN PLATFORM
13F10001000427.445 2.4097 328.1958 RAMP
13NMStart of 2-Pt Resection
13F10000000427.445 2.4097 0.0000
13F10000000323.991 4.1542 31.8042
13F10000000427.430 1.8583 121.4306
13F10000000323.976 3.8625 153.2306
08KI0011100.005 199.996 10.000
02KI0011100.005 199.996 10.000 0.100
07KI0011000344.9980 0.0000

SDR2x coordinate data format

00NMSDR20V03-05 000023-Jul-2008 18:40:111211
10NMEXAMPLE6
01K11 Nikon XS 5 000000 Nikon XS 5 00000012 0.000 0.000 0.000
13NM 080926-2 <JOB> Downloaded 08-Oct-2008 18:40:06
13NM SAMPLE <JOB> Downloaded 23-Jul-2007 18:40:06
13NMSoftware: Pre-install version: 3.3.0.1
13NMInstrument: Nikon XS 5
13NMDist Units: Metres
13NMAngle Units: Degrees
13NMZero azimuth: North
13NMZero VA: Horizon
13NMProjection correction: OFF
13NMC&R correction: OFF
13NMSea level correction: OFF
13NMCoord Order: NEZ
13NMClient:
13NMDescription:
13NMTilt Correction: VA:OFF HA:OFF
13NM EXAMPLE6 <JOB> Created 23-Jul-2008 07:09:21
13NMPrism constant: 0
08KI0001100.000 200.000 10.000
08KI0002200.000 300.000 20.000
13NMBacksight Check to Pt:2 HA:359.3525 07:21:39
13NMBacksight Pt:2 Reset to HA: 0.0000 07:21:41
08KI0003116.924 216.914 11.843 MAIN PLTFORM
08KI0004126.697 206.260 11.254 RAMP
13NMStart of 2-Pt Resection
08KI0011100.005 199.996 10.000

Error Messages

In this chapter:

- Cogo
- Communications
- Data
- Job Manager
- Programs
- Recording Data
- Searching
- Settings
- Stakeout
- Station Setup
- System Error

Cogo

NO Result

The system was unable to calculate an area because points were not entered in the correct order.

Press any key to return to the Cogo menu. Then enter the points in the correct order.

Same Coordinate

The point or coordinate that you entered is identical to the previous input point.

Press any key to return to the point input screen. Then use a different point.

XY-coordinate is required

The input point does not have XY (NE) coordinates.

Press any key to return to the point input screen. Then enter a point that has X and Y coordinates.

Communications

If an error is detected during uploading of data, the instrument aborts the upload process and displays one of the following messages.

Check Data

There are errors in the uploaded data. The uploaded data contains errors, such as an alphabetic character in a coordinate field.

Press any key. Then check the specified line in the data.

DUPLICATE PT

The uploaded data contains a duplicate PT.

Press any key. Then check the specified point in the data.



Tip – If the existing point is a UP, CC, or MP record, and is not referred by ST or BS, then it will be overwritten by the uploaded record. No error message appears.

PT MAX20 chars

The uploaded data contains a PT with a name or number that is longer than 20 digits.

Press any key. Then check the specified line in the data.

XYZ OVERRANGE

The uploaded data contains a coordinate that is longer than 13 digits.

Press any key. Then check the specified line in the data.

Data

Can't Edit Current ST

You have tried to edit the current ST.

Note – You cannot edit the current ST. However, old ST records can be edited. No recalculation can be performed on the instrument.

Press any key to return to the code/layer name input screen.

Can't Edit ST/BS refer to this PT

You have tried to edit a coordinate that the current ST or BS refers to. You cannot change a coordinate if the current ST or BS refers to it.

Press any key to return to the Data view screen.

Can't Edit XYZ from measurement

You have tried to change the coordinates of an SO, SS, or CP record. You cannot change the coordinates of an SO, SS, or CP record.

Press any key to return to the previous screen.

DELETE Stn-XYZ

You have tried to delete a coordinate record that the current ST or BS refers to. You must confirm that you want to delete a coordinate record that the current ST or BS refers to.

To ...	Press ...
delete XYZ	the DEL softkey
return to the previous screen without deleting XYZ	[ESC] or the ABRT softkey

Job Manager

Cannot Assign

You have tried to set the current job as the control file.

Press any key to return to the previous screen. Then select a different job.

Can't Create

There is no space available to create a job or record a point.

Press any key to return to the Job Manager. Then use the DEL softkey to delete old jobs.

Existing Job

You have entered an existing job name for a new job.

Press any key and then change the name for the new job.

MAX 50Jobs

You are trying to create a new job when the maximum number of jobs (50) is already stored.

Press any key to return to the Job Manager. Then use the DEL softkey to delete old jobs.

Programs

NO Stn Setup

You did not perform a station setup or BS check before entering the Programs function.

To ...	Press ...
go to the Stn Setup menu	2 or select Stn Setup
return to the BMS	ESC
go to the Programs menu	1 or select Continue



Tip – Selecting Continue does *not* resume the last ST record. You should only use the Continue option if you are sure that the previous ST coordinates and the current HA orientation are correct. Otherwise, records in the Programs function may not be correct.

XY&Z coordinate are required

Three-dimensional coordinates are required in S-Plane function.

Press any key to return to the point input screen. Then enter a three-dimensional point.

Recording Data

DATA FULL

The data storage is full.

Press any key to return to the Basic Measurement Screen (BMS). Then:

To ...	Go to ...
delete unnecessary data	MENU > Data
delete jobs	MENU > Job

DUPLICATE PT

The input PT you are trying to record already exists in the current job. An existing coordinate record cannot be overwritten by measured data.

Press any key to return to the point input screen. Change PT.

Duplicate PT

The input PT you are trying to record already exists in the current job as an SS, SO, or CP record. An existing SS, SO, or CP record can be overwritten by measured data.

To ...	Press ...
return to the PT input screen	[ESC] or the Abbr t softkey
record RAW data and update XYZ data	the XYZ softkey
record RAW data only	the RAW softkey

No Open Job

No job is open.

To ...	Press ...
open the job list, if there are existing jobs	[1] or select Select job
create a new job	[2] or select Create job
return to the previous screen	[ESC]

NO Stn Setup

There is no station record in the current job, or a station setup or BS check has not been done since the program was rebooted.

To ...	Press ...
continue recording	[1] or select Continue . If there is already an ST record in the job, the message CO, Use current orientation appears.
go to the Stn Setup menu	[2] or select STN Setup
return to the previous screen	[ESC]

OVER RANGE

You are trying to record a coordinate with more than 13 digits

Press any key to return to the previous screen. Then check the current ST coordinate.

Searching

PT Not Found

There is no point that matches the criteria you entered.

Press any key to return to the point input screen.

This message may appear in any function where the PT/CD is input, such as Station Setup or Stakeout.

Settings

Job Settings will be changed

You have changed one or more of the following job settings:

- VA zero or HA in the Angle screen (see [Angle, page 106](#))
- Scale, T-P, Sea Lvl, or C&R in the Distance screen (see [Distance, page 107](#))
- Coord or Az Zero in the Coordinates screen (see [Coordinate, page 108](#))
- Angle, Dist, Temp, or Press in the Unit screen (see [Unit, page 110](#))

To ...	Press ...
discard the changes to the job settings	[ESC] or the ABRT softkey. The current job remains open.
close the current job and save the changes to the job settings	[ENT] or the OK softkey

Note – To record a point using the new settings, create a new job using the new settings.

Stakeout

Input Error

The point name style used in the Fr field is not the same as the style used in the To field. For example, the Fr field style is 1, and the To field style is A200.

Press any key to return to the Fr/To input screen. Then re-enter the point name, using the same naming style in both fields.

NO Stn Setup

You did not perform a station setup or BS check before entering the Stakeout function.

To...	Press ...
go to the Stn Setup menu	2 or select Stn Setup
return to the Basic Measurement Screen (BMS)	ESC
go to the Stakeout menu	1 or select Continue



Tip – Selecting **Continue** does **not** resume the last ST record. You should only use the **Continue** option if you are sure that the previous ST coordinates and the current HA orientation are correct. Otherwise, records in the Stakeout function may not be correct.

Station Setup

Calc ST Failed Need additional PT

Calculating ST failed in resection. This message may appear after you have deleted a point the View shots screen.

Press any key to return to the PT input screen. Take another shot to calculate the ST coordinate.

Same Coordinate

The input PT or coordinate is identical to the current station in STN/1:Known, or the same coordinate or point name/number is found in Resection.

Press any key to return to the PT input screen. Then use a different PT.

Space LOW

There is not enough space to record a station when you start any of the Station Setup functions.

To ...	Press ...
return to the BMS	press ESC or the Abort softkey. Use the DEL softkey in Job Manager to delete old jobs.
continue	press ENT or the OK softkey. You may not be able to record the whole process.

XY-coordinate is required

The input point for ST/BS does not have N/E coordinates.

Press any key to return to the PT input screen. Then use a PT that has N/E coordinates.

Z-coordinate is required

The input point for Benchmark does not have a Z coordinate.

Press any key to return to the PT input screen. Then use a PT that has a Z coordinate.

System Error

=SYSTEM ERROR=





The system has detected an internal error that is related to the lower-level system.

Press any key to turn the instrument off. The system will reboot when this error is reported. If you still have more points to shoot in the site, turn the instrument on and repeat the open a job and station setup procedures.

Data stored before this error will be kept safely in the Job file.

If the error appears frequently, please contact your dealer or Trimble Support and report the message that appears below the =SYSTEM ERROR= line.

Appendix: XS Series 全站仪相关产品的有毒有害物质及元素的名称,含有量,环保使用期限

环保使用期限	部件名称	有毒有害物质及元素					
		铅 (Pb)	水银 (Hg)	铬 (Cd)	六价铬 (Cr ⁺⁶)	PBB (PBB)	PBDE (PBDE)
	全站仪本体						
	1) 外壳 (金属制)	×	○	○	○	○	○
	外壳 (塑胶制)	○	○	○	○	○	○
	2) 底座 / 构机部	×	○	○	○	○	○
	3) 光学镜片 / 棱镜 / 滤光镜片	○	○	○	○	○	○
	4) 电气实装部 (包括电子部品)	×	○	○	○	○	○
	5) 其他金属部品	×	○	○	○	○	○
	充电器 ※1						
	1) 充电器本体	×	○	○	○	○	○
	2) AC适配器	×	○	○	○	○	○
	3) 连接导线类	×	○	○	○	○	○
	电池部 ※1						
	电池单品 (Li-ion)	×	○	○	○	○	○
	CD-ROM (使用说明书)	○	○	○	○	○	○

备注:

- 关于有毒有害物质及元素的表示
 ○: 该部品所有均质材料的有毒有害物质含有量,不可超过GB/T26572标准所规定的限量要求
 ×: 该部品中至少有一项均质材料的有毒有害物质含有量,超过GB/T26572标准所规定的限量要求
 只是其中的任何一项在现在的技术水平下,要转换成不含有有毒有害物质,非常的困难。
 符合「关于电气电子特定有害物质的使用限制的指令2011/65/EU」中所指定的除外项目
- 关于充电器(连接导线类), 电池 (※1)
 充电器(连接导线类), 电池有和主产品一起出售, 也有单独出售的, 含有成分相同。
- 本说明书作为使用说明书的一部分, 分开印刷。

环保使用期限

此标志的数字是根据中华人民共和国电子信息产品污染控制管理办法以及有关标准等, 表示该产品环保使用期限的年数。遵守产品的安全和使用的注意, 在产品使用后采取适当的方法根据当地的法律, 规定, 回收再利用或进行废弃处理。

这些标志是面向中国客户, 在电子信息产品领域, 保护环境的标识。

These marks are for users in China, and indicate to protect environment in using the electronic information products.



CONTACT DETAILS

10368 Westmoor Drive, Suite #100
Westminster, Colorado 80021
USA

888-477-7516 (Toll Free)
1-720-587-4700 Phone

www.spectraprecision.com

For sales information and dealer locator:
sales@nikonpositioning.com

www.trimble.com